

Table of Contents

ICM-Chemist User Guide v.3.8	1
1 Help Videos on YouTube	3
2 Reference Guide	5
2.1 Graphics Reference Guide	5
2.1.1 Download and Install ICM-Browser	5
2.1.2 How to use the Graphical Display	5
2.1.3 How to make Graphical Selections	7
2.1.4 How to Convert Proteins, Display Hydrogens and Ligand Binding Pocket.	7
2.1.5 How to change Graphics Effects	7
2.1.6 How to add Labels and Annotations	8
2.1.7 How to Make High Quality Publication Images	8
2.1.8 How to Superimpose Protein Structures.	8
2.1.9 How to Measure Distances and Angles.	9
2.2 ICM-Browser-Pro Reference Guide	9
2.2.1 Download and Install ICM-Browser-Pro	9
2.2.2 Graphics	9
2.2.3 Protein Structure Analysis	9
2.2.4 Surfaces	10
2.2.5 Superimpose Proteins	10
2.2.6 Crystallographic Tools	10
2.2.7 Sequence Analysis	10
2.2.8 Plotting Tools	11
2.3 ActiveICM Reference Guide - Create 3D Molecular Documents for the Web and PowerPoint	11
Creating 3D Documents Is Straightforward	11
2.3.1 Getting Started	11
2.3.2 How to Create a Series of Fully-Interactive 3D Slides.	12
2.3.3 How to Create Molecular Documents	12
2.3.4 How to Display Molecular Documents in PowerPoint	12
2.3.5 How to Display Molecular Documents on the Web	13
2.4 ICM-Chemist Reference Guide	13
2.4.1 How to Import, Sketch, and Edit Chemicals	13
2.4.2 How to Work with Chemical Spreadsheets	13
2.4.3 How to Undertake a Chemical Search	14
2.4.4 How to Work with Pharmacophores	15
2.4.5 How to Perform Chemical Clustering	15
2.4.6 How to Generate Stereoisomers and Tautomers	15
2.4.7 How to Generate Combinatorial Libraries	16
2.4.8 How to Generate Plots and Histograms	16
2.5 Menu Option Guide	16
2.5.1 File Menu	16
2.5.2 Edit Menu	19
2.5.3 View Menu	21
2.5.4 Bioinfo Menu	26
2.5.5 Tools Menu - Xray	26
2.5.6 Tools Menu - 3D Predict	26
2.5.7 Tools Menu - Analysis	26
2.5.8 Tools Menu - Superimpose	26
2.5.9 Tools Menu - Extras	26
2.5.10 Tools Menu - Table	26
2.5.11 Tools Menu - Chemical Search	28
2.5.12 Tools Menu - Molecular Editor	28
2.5.13 Homology Menu	29
2.5.14 Chemistry Menu	29
2.5.15 Docking Menu	29
2.5.16 MolMechanics Menu	29
2.5.17 Windows Menu	29
2.6 Tab Guide	30
2.6.1 Display Tab	31
2.6.2 Light Tab	31
2.6.3 Labels Tab	31

Table of Contents

2 Reference Guide

2.6.4 PDB Search Tab	31
2.6.5 Ligedit Tab	31
2.6.6 Meshes Tab	32

3 Getting Started

3.1 The Basics of the Graphical User Interface	33
3.1.1 The Components of the GUI	33
3.1.2 How to load a PDB Structure	33
3.1.3 How to Move a Structure in the Graphical Display	34
3.1.4 How to Display Molecules using the ICM Workspace Panel	35
3.1.5 How to Make Selections	37
3.1.6 How to Change Protein Representation	38
3.1.7 How to Color	39
3.1.8 How to Display a Binding Pocket Surface	40
3.1.9 How to Save an ICM Object	41
3.1.10 How to Save an ICM Project File	42
3.1.11 How to Drag and Drop	42
3.1.12 How to: Right Click Options	42
3.1.13 How to Move Windows	42
3.1.14 How to Make a Picture	47
3.2 How to search and download Protein Structure, Sequences, and Chemicals	47
3.2.1 Search the PDB	48
How to Search the Protein Databank and Download	48
3.2.2 Search Pocketome	52
3.2.3 ChEMBL Search	54
3.2.4 Search SureChEMBL	55
3.2.5 BLAST Search	55
3.2.6 Search UniProt	56
3.2.7 Search PDB by Ligand Code	57
3.2.8 Search Drug Bank	57
3.2.9 Search PubChem	58
3.3 Create New Objects	59
3.4 Open and Read Files	60
3.4.1 Open with Password	60
3.4.2 Extract from icb file	60
3.5 Saving Files	61
3.6 Making Selections	62
3.6.1 Graphical Selection Tools	63
3.6.2 Quick Selection	63
3.6.3 How to Change the Selection Level and Mode	64
3.6.4 How to check what is selected.	64
3.6.5 Orange Selection	65
3.6.6 Clear Selection	66
3.6.7 Changing a Selection	67
3.6.8 Filter Selection	68
3.6.9 Workspace Selections	69
3.6.10 Workspace Navigation	70
3.6.11 How to Select an Object	70
3.6.12 How to select a Molecule	70
3.6.13 How to select Residues	71
3.6.14 Select All	73
3.6.15 Selecting Neighbors	73
3.6.16 Selecting Neighbors: Graphical	74
3.6.17 Selecting Neighbors: Workspace	75
3.6.18 Select by Residue Number	76
3.6.19 Alignment and Table Selections	76
3.6.20 Making Links	76
3.6.21 Tags	77
3.7 Preferences	79
3.7.1 Bonds Preferences	80
3.7.2 Directories Preferences	81
3.7.3 Graphics Preferences	82

Table of Contents

3 Getting Started	
3.7.4 GUI Preferences	84
3.7.5 GUI Preferences	85
3.7.6 Image Preferences	87
3.7.7 Label Preferences	88
3.7.8 Plot Preferences	89
3.7.9 Ribbon Preferences	89
3.7.10 Shell Preferences	90
3.7.11 System Preferences	91
4 Protein Structure	93
4.1 Convert to ICM Object	93
4.1.1 Load a Protein Structure	93
4.1.2 Converting PDB Files Into ICM Objects	93
4.2 Pocket Display	95
4.2.1 Receptor Pocket Surface	95
4.2.2 Ligand Surface	96
4.2.3 How to Display Hydrogen Bonds	97
4.2.4 Ligand Pocket Interactions	100
4.3 Crystallographic Analysis	101
4.3.1 Crystallographic Neighbor	101
4.3.2 Crystallographic Cell	103
4.3.3 Biomolecule Generator	104
4.3.4 Get Electron Density Map	105
4.3.5 Map's Original Cell	107
4.3.6 Contour Electron Density Map	107
4.3.7 Convert Xray Density to Grid	108
4.4 Protein Superposition	109
4.4.1 Select Proteins for Superposition	109
4.4.2 Superimpose Button	110
4.4.3 Superimpose by 3D	111
4.4.4 Superimpose Multiple Proteins	111
4.4.5 Arrange as Grid	112
4.4.6 Superimpose Sites by Atomic Property Fields	113
4.5 Protein Structure Analysis	119
4.5.1 Find Related Chains	119
4.5.2 Calculate RMSD	120
4.5.3 Contact Areas	120
4.5.4 Identify Closed Cavities	121
4.5.5 Surface Area	122
4.5.6 Measure Distances	123
4.5.7 Planar Angle	123
4.5.8 Dihedral Angle	124
4.5.9 Ramachandran Plot Interactive	125
4.5.10 Export Ramachandran Plot	125
4.5.11 Protein Health	126
4.5.12 Local Flexibility	126
4.5.13 Protein-Protein Interface Prediction	126
4.5.14 Identify Ligand Binding Pockets	127
5 Molecular Graphics	131
5.1 Molecule Representation	131
5.1.1 Wire Representation	132
5.1.2 Stick and Ball (Xstick) Representation	133
5.1.3 Ribbon Representation	134
5.1.4 Skin Representation	135
5.1.5 CPK Representation	136
5.1.6 Surface Representation	136
5.1.7 Display and Undisplay Hydrogens	137
5.1.8 Display Hydrogen Bond	138
5.1.9 Display Formal Charges	140
5.1.10 Ca (carbon alpha) Trace	140
5.2 Multi-Windows	140
5.3 Meshes - Surface - Grobs	141
5.3.1 Surfaces	143

Table of Contents

5 Molecular Graphics

5.3.2 MolSkin	143
5.3.3 Color Surface by Proximity	144
5.3.4 Color Surface by Selection	144
5.3.5 Meshes	145
5.3.6 Macroshape	145
5.3.7 Google 3D Objects (Sketchup)	145
5.3.8 Display or Undisplay Meshes or Surfaces	146
5.3.9 Mesh Options.	146
5.3.10 Mesh Clipping	148
5.3.11 Save Mesh	149
5.3.12 Occlusion Shading	149
5.4 Coloring	149
5.4.1 Coloring	150
5.4.2 Color Background	150
5.4.3 Background Image	151
5.5 Lighting	153
5.6 3D Stereo	153
5.7 3D Printing	154
5.8 Labeling and Annotation	154
5.8.1 Labeling	154
5.8.2 Labeling Atoms	155
5.8.3 Labeling Residues	155
5.8.4 Move Residue Label	156
5.8.5 Label Variables	156
5.8.6 Sites and Annotation	157
5.8.7 Changing Label Colors	161
5.8.8 Customized Label 2D or 3D	161
5.8.9 Undisplay Customized Label	162
5.8.10 Labeling Distances	162
5.8.11 (Un)display Origin	164
5.8.12 Displaying Tethers	164
5.8.13 Displaying Distance Restraints	165
5.8.14 Display Clash	165
5.8.15 Display Rainbow, Box, Ruler	165
5.8.16 Display Gradient	165
5.9 Display Distances and Angles	166
5.9.1 Display Distance Between Two Atoms - the quick way	166
5.9.2 Display Planar Angle	166
5.9.3 Display Dihedral Angle	166
5.9.4 Delete Label	167
5.10 Graphics Effects	167
5.10.1 Fog	167
5.10.2 Shadows	167
5.10.3 Sketch Accents	168
5.10.4 Elegant Ribbon & Ligand Sketch	168
5.10.5 Occlusion Shading	168
5.10.6 Perspective	169
5.10.7 Animate View	169
5.11 Graphics Shortcuts	171
5.12 Molecule Move Buttons	172
5.12.1 Rotation	172
5.12.2 Custom Rotation	172
5.12.3 Translation	173
5.12.4 Zoom	174
5.12.5 Center	174
5.12.6 Torsion Angles	174
5.12.7 Connect (Move)	175
5.13 Clipping Tools	176
5.13.1 Mesh Clipping	177
5.14 Graphic Layers	177
5.15 High Quality Publication Images	177
5.15.1 High Quality Image	178
5.15.2 Quick Image	179
5.15.3 Image Options	179

Table of Contents

5 Molecular Graphics

5.16 Movie Making	180
5.16.1 Making a Movie from a Set of Slides	180
5.16.2 Screenshot Movie	182

6 Slides & ActiveICM 185

6.1 Making Slides	185
6.2 Make a Movie from a Set of Slides	191
6.3 How to View and Navigate Slides	191
6.3.1 View Slide Show	191
6.3.2 Slide Navigation	191
6.4 How to Edit Slides	193
6.4.1 Edit Slide	193
6.4.2 Move Slide	194
6.5 How to Add Smooth Blending and Transition Effects Between Slides	195
6.6 How to Make Molecular Documents - Link HTML Text to Slides	196
6.6.1 How to Add Text or Edit a Molecular Document	196
6.6.2 How to Make a Hyperlink Between Text and a Slide	199
6.6.3 Insert Image	199
6.6.4 Insert Script	201
6.6.5 Insert a Dialog Box	202
6.6.6 How to add a check box.	203
6.6.7 Document Navigation	204
6.6.8 Protect Shell Objects From Deletion	204
6.7 ActiveICM	204
6.8 How to Embed in Microsoft PowerPoint 2003	205
6.9 How to Embed in Microsoft PowerPoint 2007	206
6.10 How to Embed in MicroSoft PowerPoint 2010	207
6.11 Embed in Web Browser	208
6.12 How to Use ActiveICM in PowerPoint	209
6.13 How to Change ActiveICM Component Properties	210
6.14 Advanced use of activeICM: Macros to direct visualisation changes	212
6.14.1 PowerPoint Cache Errors	215
6.15 Background Images	215
6.16 ICM JavaScript (IcmJS)	215

7 Cheminformatics 217

7.1 Read Chemical Structures	217
7.1.1 Extract 2D structure from PDB Chemical	218
7.1.2 Read Large SDF Files	218
7.1.3 Extract 3D coordinates from 3D Chemical.	219
7.2 Save Chemical Structures and Images	219
7.2.1 Save Chemical Spreadsheet Workspace	219
7.2.2 Saving Chemical Spreadsheet as SDF	219
7.2.3 Export to Excel	221
7.2.4 Saving Chemicals in the Molecular Editor	222
7.2.5 Saving Chemicals 3D Chemicals	222
7.2.6 Saving Chemical Images	222
7.2.7 IUPAC Name	223
7.3 Working with Chemical Spreadsheets.	223
7.3.1 Read and Display Chemical Spreadsheet	224
7.3.2 Chemical Spreadsheet Template	224
7.3.3 Molecular Table Display	224
7.3.4 How to add Property Columns into a Chemical Spreadsheet.	225
7.3.5 How to sort a column(s) in a chemical spreadsheet.	225
7.3.6 How to copy, cut and paste columns and rows in a chemical spreadsheet.	226
7.3.7 Add New Data to Chemical Spreadsheet	227
7.3.8 How to show and hide columns and rows in a chemical spreadsheet.	227
7.3.9 How to save a chemical spreadsheet in sdf format.	228

Table of Contents

7 Cheminformatics

7.3.10	How to export your chemical spreadsheet into Excel.	229
7.3.11	How to print a chemical spreadsheet.	229
7.3.12	How to filter columns in a chemical spreadsheet.	230
7.3.13	How to use find and replace in a chemical spreadsheet.	231
7.3.14	How to mark and label rows in a chemical spreadsheet.	231
7.3.15	How to insert hyperlinks to the PDB, PubMed, and Uniprot.	232
7.3.16	How to copy and paste 2D chemicals.	232
7.3.17	How to edit data inside a chemical spreadsheet.	233
7.3.18	How to remove salts, explicit hydrogens and standardize chemical groups.	233
7.3.19	How to calculate chemical properties in a chemical spreadsheet.	234
7.3.20	InChi	234
7.3.21	How to identify duplicate chemicals in a chemical spreadsheet.	234
7.3.22	How to compare two chemical spreadsheets.	235
7.3.23	How to merge two chemical spreadsheets.	236
7.3.24	Display and Convert Molecule	236
7.3.25	Copy Molecule	236
7.3.26	Edit Molecule	237
7.3.27	Color Table Column	237
7.3.28	Chemical View Options	237
7.3.29	Chemical Table Side-by-Side View	238
7.3.30	Zoom, Translate and Z-rotate a Chemical in a table.	239
7.3.31	Set Chemical Table 3D Browse Mode	239
7.3.32	Chemical Find and Replace	240
7.3.33	Split Chemical(s) into Fragments	242
7.3.34	Rotate Chemical for Best-Fit	243
7.3.35	Color Chemical Structure	243
7.4	Molecular Editor	244
7.4.1	Drawing a New Chemical Structure	245
7.4.2	Stereo Bond	246
7.4.3	Right Click Options	246
7.4.4	Chemical Dictionary	247
7.4.5	Dictionary of Chemical Groups	248
7.4.6	Template Menu	248
7.4.7	Set Free Radical Type	249
7.4.8	Adding and rotating a fragment in molecular editor by clicking-holding-and-dragging.	250
7.4.9	Property Monitor	250
7.4.10	Editing structure using keyboard	252
7.4.11	Chemical Editing Options	252
7.4.12	Paste SMILES or InChi String	252
7.4.13	Save Chemical in Mol/RXN Format	252
7.4.14	Save to Chemical Spreadsheet	253
7.4.15	Save as SMILES or InChi	253
7.4.16	Convert Chemical to 3D or Generate Conformers	253
7.4.17	Isis Draw Copy and Paste	253
7.5	Chemical Search	254
7.5.1	Query Setup	254
7.5.2	Filter Search	263
7.5.3	Query Processing	264
	Data Source	264
	Query Options	265
	Results	265
	Search	265
7.5.4	Search a Database by Text	266
7.5.5	Pharmacophore Drawing and Searching	266
7.6	2D Ligand Interaction Diagram	273

Table of Contents

7 Cheminformatics

7.7	Generating	Chemical	Fragments	274				
7.8	Find	Bioisostere		274				
7.8.1	2D	Bioisostere		275				
7.8.2	3D	Bioisostere		278				
7.9	Molcart			280				
7.9.1	Molcart	Installation		280				
7.9.2	Molcart	Getting	Started	281				
7.9.3	Creating	Databases	and	Importing	Data	281		
7.9.4	Molcart	Search		282				
7.9.5	Molcart	Administration		286				
7.10	Calculate	Properties		288				
7.10.1	Number	of	Atoms	289				
7.10.2	ToxScore			289				
	How	the	ToxScore	is	Calculated	290		
	How	to	Calculate	ToxScore	290			
7.11	Standardize	Table		290				
7.12	Annotate	By	Substructure		291			
7.13	Align/Color	by	2D	Scaffold		293		
7.14	Set	Formal	Charges		294			
7.15	Enumerate	Formal	Charge	States		294		
7.16	Convert			294				
7.16.1	3D	to	2D	Depiction		294		
7.16.2	Convert	Smiles	or	InChi	to	2D	295	
7.16.3	Convert	Structure	to	Smiles		296		
7.16.4	Convert	to	Racemic		296			
7.17	Predict			297				
7.18	Generate	Tautomers		297				
7.19	Generate	Stereoisomers		299				
7.20	Prodrug			302				
7.21	Ligand	Energetics		303				
7.21.1	Conformational	Entropy		303				
7.21.2	Strain			303				
7.22	Cluster	Set		304				
7.22.1	How	to	perform	chemical	clustering.	304		
7.22.2	How	to	select	representative	centers	from	a	tree.	...304
7.22.3	How	to	reorder	branches	and	change	the	distance	
	of	trees.		305				
7.22.4	How	to	edit	the	tree	-	labels,	spacing	and
	coloring.			306				
7.22.5	Auto	Close	Tree	Mode	306			
7.22.6	Calculate	Maximum	Common	Substructure	for	Nodes	306	
7.22.7	R	Group	Decomposition	from	Clustering	Node	307	
7.23	PCA	Analysis		308				
7.24	Visualize	Chemical	Space		308			
7.24.1	Maximum	Common	Substructure	(MCS)	Dendrogram	308		
7.24.2	Self	Organized	Map		309			
7.25	Compare	Two	Sets		310			
7.26	Merge	Two	Sets		311			
7.27	Select	Duplicates		311				
7.28	Multi	Parameter	Optimization		312			
7.29	Combinatorial	Chemistry		314				
7.29.1	Sketch	Markush	Structure		314			
7.29.2	R-Groups			315				
7.29.3	Create	Markush		316				
7.29.4	Enumerate	by	Scaffold		318			
7.29.5	Enumerate	by	Reaction		319			
7.30	SAR	Analysis		321				
7.30.1	R-Group	Decomposition		321				
7.30.2	SAR	Table		324				
7.30.3	Plot	R-Groups		326				
7.30.4	Generate	SALI	Table		326			
7.30.5	Matched	Pair	Analysis		327			

Table of Contents

8 Working with Tables and Plots	331
8.1 Standard ICM Tables	331
8.1.1 Generate New Table	331
8.1.2 Reading a Table	332
8.1.3 Saving a table	332
8.1.4 Basic Table Navigation	332
8.1.5 Table View (Grid Layout)	333
8.1.6 Change Row Height	333
8.1.7 Table View Save	333
8.1.8 Table Search	334
8.1.9 Table Color	334
8.1.10 Table Font	336
8.1.11 Table Alignment	336
8.1.12 Mark a Row	336
8.1.13 Table right click options	337
8.1.14 Rename a Table	337
8.1.15 Clone a Table	337
8.1.16 Delete a Table	337
8.1.17 Page Setup	338
8.1.18 Print a Table	338
8.1.19 Export to Excel	338
8.1.20 Save a Table	338
8.1.21 Change Column and Row Width	338
8.1.22 Making Table Selections	338
8.1.23 Editing a Table	341
8.1.24 Rename Column	341
8.1.25 Inserting Columns	341
8.1.26 Increment ID Number	343
8.1.27 Column Visibility	343
8.1.28 Column Order	343
8.1.29 Freeze Column	344
8.1.30 Freeze Row	344
8.1.31 Column Statistics	344
8.1.32 Inserting Rows	345
8.1.33 Insert Image	345
8.1.34 Copy Cut and Paste Row	345
8.1.35 Copy Cell	346
8.1.36 Copy Selection to an ICM Table	346
8.1.37 Deleting Columns and Rows	346
8.1.38 Hide and Show Columns	346
8.1.39 Column Format and Custom Actions	347
8.1.40 Column Table Annotation	349
8.1.41 Table Sorting	350
8.1.42 Table Filtering	350
8.1.43 Append Table	353
8.1.44 Mark and Select Rows	353
8.1.45 Group View by Column	353
8.1.46 Mouse and Cursor Actions on a Table	354
8.2 Molecular Tables	355
8.3 Insert Interactive Objects into Table Cell	355
8.4 Plotting Table Data	356
8.4.1 Column Histogram	356
8.4.2 Histogram Options	357
8.4.3 Histogram Bins	358
8.4.4 Plots	358
8.4.5 Multiple Curves	359
8.4.6 Heatmap	360
8.4.7 Pie Chart	363
8.4.8 Add a title to a plot	363
8.4.9 Axis Options	363
8.4.10 Change Axis Data	364
8.4.11 Logarithmic Plots	364
8.4.12 Change Mark Shape or Size	364
8.4.13 Change Mark Color	364
8.4.14 Grid and Axis Display	365

Table of Contents

8 Working with Tables and Plots	
8.4.15 Least Squares Fitting	366
8.4.16 Zoom, Translate and Center	366
8.4.17 Plot Selection	367
8.4.18 Point Label	369
8.4.19 Print Plot	371
8.4.20 Saving a Plot Image	371
8.4.21 Table Inline Plots	371
8.4.22 Annotate Plot	372
8.4.23 Plot R-Groups	372
8.4.24 Tooltips Balloons	373
8.5 Principal Component Analysis	374
8.6 Learn and Predict	375
8.7 Data Clustering	376
8.7.1 Cluster	376
8.7.2 Tree Selection	378
8.7.3 Save and Print Tree	379
8.7.4 Tree View	379
9 Working with Local Databases	385
9.1 How to make a local database.	385
9.2 Browse Database	385
9.3 Edit Database	388
9.4 Query Local Database	390
10 Tutorials	391
10.1 Graphics Tutorials	392
Introduction	392
10.1.1 Change Molecule Representation and Color	393
10.1.2 Annotation	396
10.1.3 Labels	397
10.1.4 2D and 3D Labels	400
10.2 Creating Fully Interactive Slides for PowerPoint and the Web Tutorial	403
Introduction	403
Tutorial	403
10.3 Protein Structure Tutorials	410
Introduction	410
Tutorial	410
10.3.1 PDB Search	410
10.3.2 Convert PDB to ICM Object	411
10.3.3 Protein Superposition	412
10.3.4 Protein Structure Analysis	413
10.3.5 Contact Areas	415
10.3.6 Hydrogen Bond	416
10.3.7 Pocket Identification	416
10.3.8 Protein Preparation and Crystallographic Analysis Tutorial	417
10.3.9 PDB Preparation - Symmetry	417
10.3.10 PDB Preparation - Occupancy and B-Factors	418
10.3.11 PDB Preparation - Residue Alternative Orientation	419
10.3.12 Biomolecule Generator	420
10.4 Cheminformatics Tutorials	422
10.4.1 Chemical Draw and Spreadsheet Tutorial	422
Background	422
Tutorial	422
10.4.2 Chemical Searching	431
Background	431
Tutorial	431
10.4.3 Chemical Clustering	437
Background	437
Tutorial	437
10.4.4 Working with Large Chemical Space	439
10.4.5 3D Pharmacophore Searching	446
10.4.6 2D Pharmacophore Searching	447

Table of Contents

10 Tutorials

10.4.7 How to create a Markush structure.	448
10.4.8 How to enumerate a Markush library.	450
10.4.9 How to decompose a library based on a Markush structure.	453
10.4.10 How to enumerate a chemical library by reaction. ...	456
10.4.11 Detecting Activity Cliffs	457

Index	463
--------------------	------------

ICM-Chemist User Guide v.3.8

by Ruben Abagyan, Andrew Orry, Eugene Raush, and Maxim Totrov
Copyright 2017

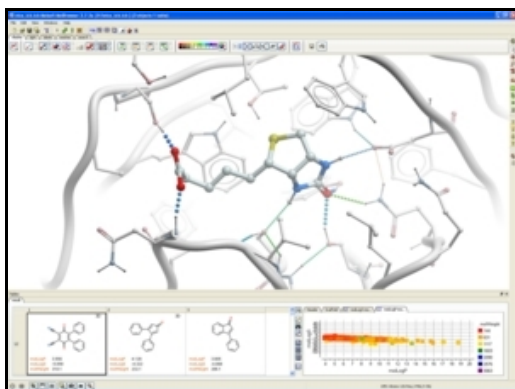

Sep 13 2018

Feedback.

1 Help Videos on YouTube

You can view webinars and how-to videos on many of the functions within ICM on YouTube.

- [Link to our YouTube Channel.](#)
- [Link to our Webinar Archives on YouTube.](#)

2 Reference Guide

Chapter Contents:

ICM-Browser Reference Guide

ICM-Browser-Pro Reference Guide

ActiveICM Reference Guide - Create 3D Molecular Documents for the Web and PowerPoint

ICM-Chemist Reference Guide

ICM-Chemist-Pro Reference Guide

Menu and Tab Reference Guide:

Menu Option Guide

Tab Guide

2.1 Graphics Reference Guide

Available in the following product(s): ICM-Browser | ICM-Browser-Pro
| ICM-Chemist | ICM-Pro

For instructions on how to use ICM-Browser to make fully-interactive 3D slides and publish them in PowerPoint and the web please see the ActiveICM User Guide. ActiveICM is a free plugin for Windows PowerPoint and web browsers. Other related tutorials include:

- Graphical Display: Molecule Representation, Coloring, Labeling and Annotation
- Graphical Selections Tutorial
- Creating Fully Interactive Slides for PowerPoint and the Web Tutorial

2.1.1 Download and Install ICM-Browser

Getting Started: Download and Install ICM-Browser and ActiveICM.		
Download ICM-Browser Distribution.	Download	video
Install ICM-Browser Instructions.	Windows Linux Mac	
Download ActiveICM Distribution.	Download	video
Install ActiveICM.	Windows Linux Mac	

2.1.2 How to use the Graphical Display

```
}; winRef.document.write(str); }
```

How to use the Graphical Display		
How to search the PDB.	HTML GUI Manual	video
How to Move a Structure in the Graphical Display.	HTML GUI Manual	video
How to use the Graphics window controls.	HTML GUI Manual	
How to use the ICM Workspace Panel	HTML GUI Manual	video
How to Display a Molecule.	HTML GUI Manual	video
How to Change Protein Representation.	HTML GUI Manual	video
How to Change Ribbon Representation.	HTML GUI Manual	video
How to color wire or xstick carbon atoms.	HTML GUI Manual	video
How to Display the Residues Surrounding the Ligand Binding Pocket.	HTML GUI Manual	video
How to remove chain breaks (dotted lines).	HTML GUI Manual	video
How to Color.	HTML GUI Manual	video
How to Change the Color of Molecule Representations.	HTML GUI Manual	video
How to Change the Background Color.	HTML GUI Manual	video
How to Display a Binding Pocket Surface	HTML GUI Manual	video
How to (Un)Display Hydrogens.	HTML GUI Manual	video
How to Save an ICM Object.	HTML GUI Manual	video
How to Save an ICM Project File.	HTML GUI Manual	video
How to Drag and Drop.	HTML GUI Manual	
How to: Right Click Options.	HTML GUI Manual	

How to Move Windows.	HTML GUI Manual	video
How to Arrange Windows	HTML GUI Manual	video

2.1.3 How to make Graphical Selections

How to Make Selections.	HTML GUI Manual	
How to Select an Object	HTML GUI Manual	video
How to Select a Molecule	HTML GUI Manual	video
How to Select Residues	HTML GUI Manual	video
How to Select Atoms	HTML GUI Manual	video
How to Make a Spherical Selection.	HTML GUI Manual	video
How to Invert a Selection.	HTML GUI Manual	video
How to Remove a Selection.	HTML GUI Manual	video
How to Change the Selection Level and Mode.	HTML GUI Manual	video
How to Check What is Selected.	HTML GUI Manual	

2.1.4 How to Convert Proteins, Display Hydrogens and Ligand Binding Pocket.

Convert Protein, Display Hydrogens and Ligand Binding Pocket.		
How to Convert a PDB Structure into an ICM Object.	HTML GUI Manual	video
How to Display Ligand Binding Pocket.	HTML GUI Manual	video
How to Display Hydrogen Bonds.	HTML GUI Manual	video

2.1.5 How to change Graphics Effects

How to change Graphics Effects		
How to display the FOG effect.	HTML GUI Manual	video
How to display side-by-side stereo.	HTML GUI Manual	
How to display Anaglyph stereo.	HTML GUI Manual	
How to toggle full screen mode.	HTML GUI Manual	video

How to adjust perspective.	HTML GUI Manual	
How to change the lighting.	HTML GUI Manual	video
How to display sketch accents.	HTML GUI Manual	video
How to display elegant ribbon and ligand sketch.	HTML GUI Manual	video

2.1.6 How to add Labels and Annotations

How to add Labels and Annotations		
How to Label Residues.	HTML GUI Manual	video
How to Label Atoms.	HTML GUI Manual	video
How to Label Variables.	HTML GUI Manual	video
How to Display and Undisplay Sites.	HTML GUI Manual	
How to Make and Display Sites (Annotations).	HTML GUI Manual	
How to Make and Display 2D and 3D Labels.	HTML GUI Manual	video

2.1.7 How to Make High Quality Publication Images

How to Make High Quality Publication Images		
How to Toggle High Quality Display	HTML GUI Manual	video
How to Toggle Antialiasing.	HTML GUI Manual	video
How to Copy Image to ClipBoard	HTML GUI Manual	video
How to Write an Image.	HTML GUI Manual	video
How to Use the Advanced Write Image Options.	HTML GUI Manual	video
How to Add an Image to the ICM Photo Album.	HTML GUI Manual	video

2.1.8 How to Superimpose Protein Structures.

How to Superimpose Protein Structures.		
How to Superimpose Two or More Protein Structures.	HTML GUI Manual	video

2.1.9 How to Measure Distances and Angles.

How to Measure Distances and Angles.		
How to Measure Distances Between Two Atoms.	HTML GUI Manual	video
How to Measure Distances From One Atom to Many.	HTML GUI Manual	video
How to Show Corresponding Distances in Two Objects.	HTML GUI Manual	video
How to Display the Ruler Bar.	HTML GUI Manual	video

2.2 ICM-Browser-Pro Reference Guide

NOTE: ICM-Browser-Pro contains all the features in ICM-Browser. Click [here](#) for the ICM-Browser Reference Guide.

2.2.1 Download and Install ICM-Browser-Pro

Getting Started: Download and Install ICM-Browser-Pro	
Download ICM-Browser-Pro Distribution.	Download
Install ICM-Browser-Pro.	Windows Linux Mac

2.2.2 Graphics

Graphics and Movie Making	
How to generate the shadow effect.	HTML GUI Manual
How to make a screenshot movie.	HTML GUI Manual
How to make a movie from a set of slides.	HTML GUI Manual
How to move a molecule independently of the other display objects (Connect).	HTML GUI Manual

2.2.3 Protein Structure Analysis

Protein Structure Analysis	
How to calculate contact areas between molecules.	HTML GUI Manual
How to identify closed cavities.	HTML GUI Manual

How to calculate surface area.	HTML GUI Manual
How to generate interactive Ramachandran plots.	HTML GUI Manual

2.2.4 Surfaces

Surfaces	
How to generate electrostatic and binding property surfaces.	HTML GUI Manual
How to connect and rotate/translate surface (mesh).	HTML GUI Manual
How to crop a mesh/surface.	HTML GUI Manual
How to save a mesh/surface.	HTML GUI Manual

2.2.5 Superimpose Proteins

Superimpose Proteins	
How to superimpose proteins based on 3D by visible atoms, C-alpha, backbone or heavy atoms.	HTML GUI Manual
How to superimpose multiple proteins based on aligned residues..	HTML GUI Manual

2.2.6 Crystallographic Tools

Crystallographic Tools	
How to contour electron density.	HTML GUI Manual
How to display crystallographic cell.	HTML GUI Manual
How to display crystallographic symmetry.	HTML GUI Manual
How to convert x-ray density to a grid.	HTML GUI Manual

2.2.7 Sequence Analysis

Sequence Analysis	
How to annotate an alignment - box and shade.	HTML GUI Manual
How to annotate an alignment with text.	HTML GUI Manual
How to display secondary structure in an alignment.	HTML GUI Manual

How to extract sequences from pdb files.	HTML GUI Manual
How to assign secondary structure.	HTML GUI Manual
How to link sequence, alignments, and structures.	HTML GUI Manual
How to save as image, print, and delete sequences and alignments.	HTML GUI Manual

2.2.8 Plotting Tools

Plotting Tools	
Make fully interactive colorful X-Y plots and histograms with up to 4 dimensions.	HTML GUI Manual
Save plot and histogram as image.	HTML GUI Manual

2.3 ActiveICM Reference Guide - Create 3D Molecular Documents for the Web and PowerPoint

This guide is focused on how to make fully interactive 3D documents for Windows PowerPoint and the Web. For more information on the other features in ICM-Browser please see the ICM-Browser User Guide.

Creating 3D Documents Is Straightforward

Creating fully interactive 3D documents for PowerPoint, the web, and standalone browser is straightforward.

1. Download ICM-Browser and the ActiveICM plugin. They are completely free! [video]
2. Open the ICM-Browser and make a series of animated fully-interactive slides showing different colored and rendered views of your molecules. [video]
3. Add hyperlinked HTML text to annotate and link to your slides. [video]
4. Save your file in ICM-Browser and then insert into PowerPoint or the web using the ActiveICM plugin. You can also share your documents in the standalone ICM-Browser. [video - powerpoint] [video -web browser]

```
}; winRef.document.write(str); }
```

2.3.1 Getting Started

Getting Started: Download and Install ICM-Browser and ActiveICM.		
Download ICM-Browser Distribution.	Download	video

Install ICM-Browser Instructions.	Windows Linux Mac	
Download ActiveICM Distribution.	Download	video
Install ActiveICM.	Windows Linux Mac	

2.3.2 How to Create a Series of Fully-Interactive 3D Slides.

Creating Slides How to Create a Series of Fully-Interactive 3D Slides.	video
How to Make Fully Interactive 3D Slides	HTML GUI Manual
How to Animate Slides	HTML GUI Manual
How to View and Navigate Slides in the ICM-Browser.	HTML GUI Manual
How to Edit Slides.	HTML GUI Manual
How to Add Smooth Blending and Transition Effects Between Slides.	HTML GUI Manual

2.3.3 How to Create Molecular Documents

How to Create Molecular Documents: Linking Slides to HTML Text.	video
How to Create an HTML Document.	HTML GUI Manual
How to Edit an HTML Document.	HTML GUI Manual
How to Make a Hyperlink Between HTML Text and a Slide.	HTML GUI Manual

2.3.4 How to Display Molecular Documents in PowerPoint

How to Display Molecular Documents in PowerPoint	video
How to Embed in Microsoft PowerPoint 2003	HTML GUI Manual
How to Embed in Microsoft PowerPoint 2007	HTML GUI Manual
How to Use ActiveICM in PowerPoint	HTML GUI Manual

How to Change ActiveICM Component Properties in PowerPoint	HTML GUI Manual
Advanced use of ActiveICM: Macros to direct visualisation changes.	HTML GUI Manual

2.3.5 How to Display Molecular Documents on the Web

How to Display Molecular Documents in Web Browsers	video
How to Display Molecular Documents in Web Browsers	HTML GUI Manual

2.4 ICM-Chemist Reference Guide

2.4.1 How to Import, Sketch, and Edit Chemicals

How to Import, Sketch, and Edit Chemicals		
How to load the ICM Molecular Editor.	HTML GUI Manual	video
How to sketch chemicals in the ICM Molecular Editor.	HTML GUI Manual	video
How to save a 2D sketch into a chemical spreadsheet.	HTML GUI Manual	video
How to save a 2D sketch in mol format.	HTML GUI Manual	video
How to use SMILES strings to sketch a chemical.	HTML GUI Manual	video
How to load a mol, sdf or mol2 file.	HTML GUI Manual	video
How to extract a 2D sketch of a ligand in complex with a PDB structure.	HTML GUI Manual	video

2.4.2 How to Work with Chemical Spreadsheets

Working with Chemical Spreadsheets		
How to add columns into a chemical spreadsheet.	HTML GUI Manual	video
How to sort a column(s) in a chemical spreadsheet.	HTML GUI Manual	video
How to change the view of a chemical spreadsheet - form, table and grid.	HTML GUI Manual	video

How to copy, cut and paste columns and rows in a chemical spreadsheet.	HTML GUI Manual	video
How to show and hide columns and rows in a chemical spreadsheet.	HTML GUI Manual	video
How to save a chemical spreadsheet in sdf format.	HTML GUI Manual	video
How to export your chemical spreadsheet into Excel.	HTML GUI Manual	video
How to print a chemical spreadsheet.	HTML GUI Manual	video
How to filter columns in a chemical spreadsheet.	HTML GUI Manual	video
How to use find and replace in a chemical spreadsheet.	HTML GUI Manual	video
How to mark and label rows in a chemical spreadsheet.	HTML GUI Manual	video
How to insert hyperlinks to the PDB, PubMed, and Uniprot.	HTML GUI Manual	video
How to copy and paste 2D chemicals.	HTML GUI Manual	video
How to edit data inside a chemical spreadsheet.	HTML GUI Manual	video
How to remove salts, explicit hydrogens and standardize chemical groups.	HTML GUI Manual	video
How to calculate chemical properties in a chemical spreadsheet.	HTML GUI Manual	video
How to identify duplicate chemicals in a chemical spreadsheet.	HTML GUI Manual	video
How to compare two chemical spreadsheets.	HTML GUI Manual	video
How to merge two chemical spreadsheets.	HTML GUI Manual	video

2.4.3 How to Undertake a Chemical Search

How to Perform Chemical Searching		
How to setup a chemical search.	HTML GUI Manual	video
How to draw a chemical search query.	HTML GUI Manual	video

How to add conditions to your chemical search.	HTML GUI Manual	video
How to search chemical spreadsheets, local databases and MolCart.	HTML GUI Manual	video
How to send a chemical search query.	HTML GUI Manual	video

2.4.4 How to Work with Pharmacophores

How to Work with Pharmacophores		
How to draw 2D pharmacophore.	HTML GUI Manual	video
How to search a 2D pharmacophore.	HTML GUI Manual	video
How to draw 3D pharmacophore.	HTML GUI Manual	video
How to extract a 3D pharmacophore from a ligand.	HTML GUI Manual	video
How to edit a 3D pharmacophore.	HTML GUI Manual	video
How to send a 3D pharmacophore search query.	HTML GUI Manual	video
How to color a 2D chemical sketch by pharmacophore feature.	HTML GUI Manual	video

2.4.5 How to Perform Chemical Clustering

How to Perform Chemical Clustering		
How to perform chemical clustering.	HTML GUI Manual	video
How to select representative centers from a tree.	HTML GUI Manual	video
How to reorder branches and change the distance of trees.	HTML GUI Manual	video
How to edit the tree - labels, spacing and coloring.	HTML GUI Manual	video

2.4.6 How to Generate Stereoisomers and Tautomers

How to Generate Stereoisomers and Tautomers		
How to generate stereoisomers.	HTML GUI Manual	video
How to generate tautomers.	HTML GUI Manual	video

2.4.7 How to Generate Combinatorial Libraries

How to Generate Combinatorial Libraries		
How to enumerate a Markush library.	HTML GUI Manual	video
How to decompose a library based on a Markush structure.	HTML GUI Manual	video
How to create a Markush structure.	HTML GUI Manual	video
How to enumerate a chemical library by reaction.	HTML GUI Manual	video

2.4.8 How to Generate Plots and Histograms

How to Generate Plots and Histograms		
How to make a histogram.	HTML GUI Manual	video
How to make an X-Y scatter plot.	HTML GUI Manual	video

2.5 Menu Option Guide

Note: Click **Next** (top right hand corner) to navigate through this chapter. Headings are listed on the left hand side (web version) or by clicking the **Contents** button on the left-hand-side of the help window in the graphical user interface.

Here we describe all the options in the drop down graphical user interface menus.



2.5.1 File Menu

2.5.1.1 New

This option allows you to create new peptides, dna, sequences etc... and is described in the `Create New Objects` chapter.

2.5.1.2 New ICM Session

File/New ICM Session

This option allows you to generate a new clear ICM session or clone the current one.

2.5.1.3 Open

File/Open

This option is described in the `Open` and `Read` chapter.

2.5.1.4 Open with Password

File/Open with Password

This option is described in the `Open` and `Read` chapter.

2.5.1.5 Extract from ICB

File/Extract from ICB

This option is described in the `Open` and `Read` chapter.

2.5.1.6 Convert to Local Database

Please see the `Local Databases` chapter for more information about this option.

2.5.1.7 Load

Options contained within the menu `File/Load`

PDB - read PDB from FTP, http, and local PDB

From Multiple Object File - A multiple object file will have a file extension *.ob and you can select which member of the multiple object is displayed.

PFam Alignment - PFam is a collection of multiple sequence alignments - enter FASTA ID

SwissProt - Download SwissProt sequence.

All Images from Dir - Read into ICM multiple image files png or jpg.

Electron Density Map - Download electron density map from Uppsala electron density server <http://eds.bmc.uu.se/eds/>

3D Mesh in KMZ or COLLADA Format from Google - see <http://sketchup.google.com/3dwarehouse/> to download KMZ or COLLADA.

2.5.1.8 Save Project

This is described in the `Save File` chapter.

2.5.1.9 Save Project As

This is described in the `Save File` chapter.

2.5.1.10 Save Project Compatible with ICM 3_5

File/Save Project Compatible with ICM 3_5

Use this option to save a version of your ICM project compatible with an older version of ICM. Version 3.5 or older. If you have an ICM license you can update your version of ICM by visiting our support site at www.molsft.com/support

2.5.1.11 Save with Password

To save a project which is protected by a password:

- File/Save with Password
- Enter a file name or browse for a previously saved project.
- Enter a password
- Determine whether you want the file to be **Fully Protected, read only** or **Read Only and Allow Comments** .

2.5.1.12 Export as ActiveICM Html

To embed in a web browser.

1. Download ActiveICM from here <http://www.molsoft.com/getbrowser.cgi?product=activeicm&act=list> (it is free!).
2. Create an HTML page in ICM (File/New/Html).
3. Add a series of slides.
4. File/Export As ActiveICM Html..

2.5.1.13 Close Project

To close a project:

File/Close Project

2.5.1.14 Quick Image

See the `High Quality Publication Image` chapter.

2.5.1.15 Write Image

See the `High Quality Publication Image` chapter.

2.5.1.16 Preferences

Preferences are described in the `Preferences` chapter.

2.5.1.17 Recent Files

Recently viewed projects and files can be easily downloaded from the "Recent Files" option. To access this:

- Select File/Recent Files.
- Select the desired project by clicking on it once.

2.5.1.18 Recent PDB Codes

Quickly retrieve and display PDB structures that have recently been viewed.

- Select File/Recent PDB Codes
- Select desired PDB code by clicking on it once and it will be loaded into the graphical display.

2.5.1.19 Quit

Need to close down ICM - no problem. You do one of the following:

1. Select **File/Quit**. ICM will quit without saving files.
2. Save and Click **X** at the upper right corner of the ICM window.
3. Type `quit` in the terminal window.

NOTE: You may want to save the `icm` session as an `ICM Project file` before quitting.

2.5.2 Edit Menu

2.5.2.1 Delete

This option will delete anything that is selected.

2.5.2.2 Delete All

This option will delete everything e.g. sequences, structures, tables ... Use with care!

2.5.2.3 Select All

This option will select everything e.g. sequences, structures, tables...

2.5.2.4 Search in Workspace

This option allow you to search for a particular text in the workspace

2.5.2.5 Selection

This option allows you to make a precise selection either by neighbors or specifying a particular atom or neighbor. Click on the tabs to jump between selection levels.

2.5.2.6 Invert Selection

This option will select everything that is not currently selected.

2.5.2.7 Clear Selection

This option will remove all selections. For more information on selections see the `Making Selections` Chapter.

2.5.2.8 Neighbor Selection

This option will allow you to select neighboring atoms. For more information see the `Select Neighbors` section in the `Selections` Chapter.

2.5.2.9 Undo

Due to the complexities of working in an internal coordinates environment not everything can be undone or redone. Certain things like coloring and representations can be undone or redone.

2.5.2.10 Redo

Due to the complexities of working in an internal coordinates environment not everything can be undone or redone. Certain things like coloring and representations can be undone or redone.

2.5.2.11 Restore Recent Backup

ICM periodically makes a backup of your ICM project. If for whatever reason you lose an ICM session and you want to load the backup for the file use:

Edit/Restore Recent Backup

2.5.2.12 PDB Search

See `PDB Search Tab`

2.5.2.13 PDB Search by Field

See `PDB Search Tab`

2.5.2.14 PDB Search by Identity

See `PDB Search Tab`

2.5.2.15 PDB Search by Homology

See `PDB Search Tab`

2.5.2.16 PDB Search with External Sequence

See `PDB Search Tab`

2.5.2.17 Ligand Tools

See the ligand editor section of the manual.

2.5.2.18 Ligand Editor Preferences

See the ligand editor section of the manual.

2.5.3 View Menu

View Menu

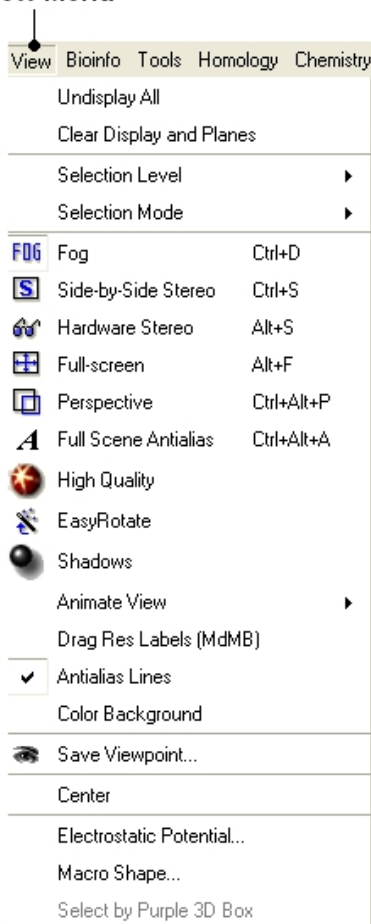

View Buttons

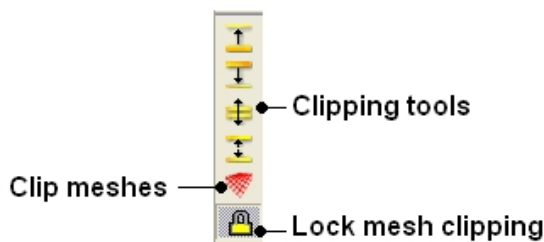
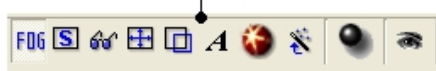

2.5.3.1 Undisplay All

To undisplay everything currently displayed in the graphical display

- View/Undisplay All

Note For more details on displaying structures please see the GUI Overview chapter.

2.5.3.2 Clear Display & Planes

To clear the display and planes

- View/Clear Display and Planes

NOTE: For more details on planes please see the sections on clipping tools and mesh clipping.

2.5.3.3 Selection Level

There are four levels of selection - atom, residue, molecule and object. For more details on selections please see the Making Selections section.

2.5.3.4 Selection Mode

There are four different ways to make selections - new, add, remove and toggle. For more details on selections please see the Making Selections section.

2.5.3.5 Fog

Fog Toggle(Ctrl + D) : this feature creates a fog-like environment for your object, so that the part of your structure that is closer appears clear and the distant parts are faded as if they are in fog. The clipping planes control the point at which the fog begins.

- View/Fog

2.5.3.6 Side-by-Side Stereo

Side-by-side stereo toggle(Ctrl + S) : this feature allows you to view your structure in 3D form without any 3D goggles.

- View/Side-by-Side Stereo

2.5.3.7 Hardware Stereo

Hardware stereo toggle(Alt + S) - if you have 3D goggles and you wish to view your structure in 3D form, this feature will allow you to do so.

- View/Hardware Stereo

2.5.3.8 Full Screen

Full screen toggleAlt_F - this makes your graphical display fill the entire screen. If you wish to exit this mode, press escape.

- View/Full Screen

2.5.3.9 Perspective

Toggle perspective Ctrl_P this will add perspective to your structure, enhancing depth in the graphical display.

- View/Perspective

2.5.3.10 Full Scene Antialias

Anti-aliasing is the technique of minimizing the distortion artifacts known as aliasing when representing a high-resolution signal at a lower resolution. Always use this option before making high resolution images.

- View/Full Scene Antialias

2.5.3.11 High Quality

Toggle High Quality: this option will give your ICM object better resolution and higher quality. The change in quality is most visible at a high magnification. However, if your object is very large, this feature could slow down your program.

Always use this option before making high resolution images.

- View/High Quality

2.5.3.12 Easy Rotate

Toggle easy rotation: this feature is necessary if your structure is very large or perhaps your computer cannot quickly rotate it. It will prevent your structure from fully loading each time you rotate it, therefore speeding up the process.

- View/Easy Rotate

2.5.3.13 Shadows

- View/Shadows

See Graphics Effects chapter.

2.5.3.14 Sketch Accents

To make images as shown below use:

- View/Sketch Accents

See Graphics Effects chapter.

2.5.3.15 Animate View

This tool is described in more detail in the Molecular Animations and Transitions section.

2.5.3.16 Drag Res Labels

To change the location of your residue label:

- Select View/Drag res labels.
- If your mouse has a middle mouse button, then click on handle (as shown) of the label you wish to move, and drag it to your desired area.

Click on
this area
to drag
your
label.



- If your mouse does not have a middle mouse button, then click on the Translation icon on the toolbar, and click on the handle (as shown) of the label you wish to move, and drag it to your desired area.

The +/- buttons on the side of the Residue and Atom buttons will shift the label. There are also other **residue label move** options available

when you click and hold the residue label button. These options include **Shift to Sidechain Tips**, **Shift to Calphas**, and **Restore Positions**

2.5.3.17 Antialias Lines

Use this option to activate antialias lines. It is recommended to leave this option selected.

- View/Antialias Lines

2.5.3.18 Color Background

To change the background color

- View/Color Background
- Select a color from the panel and press OK.

This option is also in the more convenient `display` tab.

2.5.3.19 Save Viewpoint

It is possible to store a current view using the button shown below.



Store Current View

Click on the button and the current view will be stored so that you can view it later. A data entry box will be displayed asking you to name the view. All stored views can be found in the ICM workspace as shown below.



- Double click on the view in the ICM Workspace to display it.

A number of view display options are available by right clicking on the view in the ICM workspace as shown below.

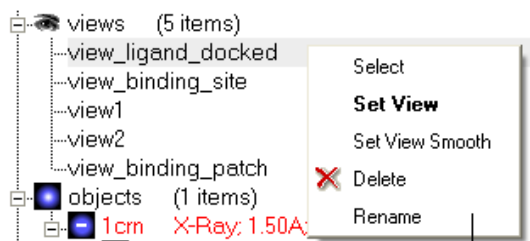

Store current view right click menu

The option in the right click menu called "set view smooth" returns to the view slowly showing the trajectory between the original view and the current one.

2.5.3.20 Center

To center on an object displayed in the graphical display

- Make a selection on the region on which you wish to center on.
- Tools/Center (or use the `center` button on the right hand-side of the graphical display).

2.5.3.21 Electrostatic potential

This option generates the skin representation of the molecular surface colored according to the electrostatic potential calculated by the REBEL method (hydrogen atoms are ignored). REBEL is a method to solve the Poisson equation for a molecule. REBEL is a powerful implementation of the boundary element method with analytical molecular surface as dielectric boundary. This method is fast (takes seconds for a protein) and accurate. REBEL stands for Rapid Exact-Boundary ELectrostatics. The energy calculated by this method consists of the Coulomb energy and the solvation energy

In order to color the skin of your molecule by electrostatic potential:

- Select **View/Electrostatic** potential.
- Enter the potential scale value. This is the local electrostatic potential in kcal/e.u.charge units at which the surface element is colored by extreme red or extreme blue. All higher values will have the same color. This absolute scaling is convenient to develop a feeling of electrostatic properties of molecular surfaces.
- Areas colored blue represent positive areas and red represents negative areas.

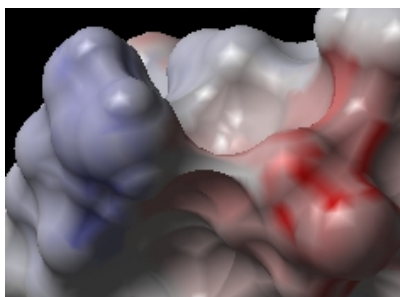

2.5.3.22 Macro Shape

A macroshape allows easy viewing and manipulation of a structure. A macroshape representation is ideal for large structures which allows the user to easily identify important regions of the structure and facilitate the return to the 'standard' view of a particular molecule. The level of detail displayed in the macroshape can be controlled by changing the number of harmonics, gridStep, and, contour level.

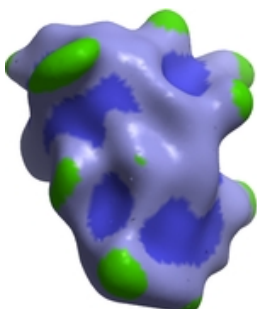

- View/Macro Shape

2.5.3.23 Select by Purple 3D Box

An alternative way to make a make-selection{selection} is to use the purple 3D box. To do this:

- Select the **display** tab and the purple box button
- View/ Select by Purple 3D Box
- The atoms contained within the purple box will be selected.

2.5.4 Bioinfo Menu

The tools in this menu are described in the Bioinfo Menu chapter.

2.5.5 Tools Menu - Xray

The options in the menu are described in the Crystallographic Analysis chapter.

2.5.6 Tools Menu - 3D Predict

The options in this menu are described in the 3D Predict chapter.

2.5.7 Tools Menu - Analysis

The options in this menu are described in the Protein Structure Analysis chapter.

2.5.8 Tools Menu - Superimpose

The options in this menu are described in the Protein Superposition chapter.

2.5.9 Tools Menu - Extras

2.5.9.1 Plot Function

To plot a function:

- Tools/Extras/Plot Function
- Enter the Function(x) eg Sin(x)
- Enter the starting value of x (From).
- Enter the end point of x (To).
- Enter the number of points (N points).
- Click OK and your plot will be displayed next to a table of values for your function.

2.5.10 Tools Menu - Table

2.5.10.1 Build Prediction Model

Learn and Predict tools are described here.

2.5.10.2 Predict

Learn and Predict tools are described here.

2.5.10.3 Cluster Set

This is described in the `cluster` section of the Working with Tables Chapter.

2.5.10.4 Sort Table

There are a couple of ways to sort a chemical table. You can right click on the a column header and select `sort` or you can use the option in the menu Chemistry/Sort Table.

- Read a chemical table into ICM.
- Select the columns by which you wish to sort by as shown below.
- Select **Ascending** or **Descending** and for each **sort by** option and then click OK

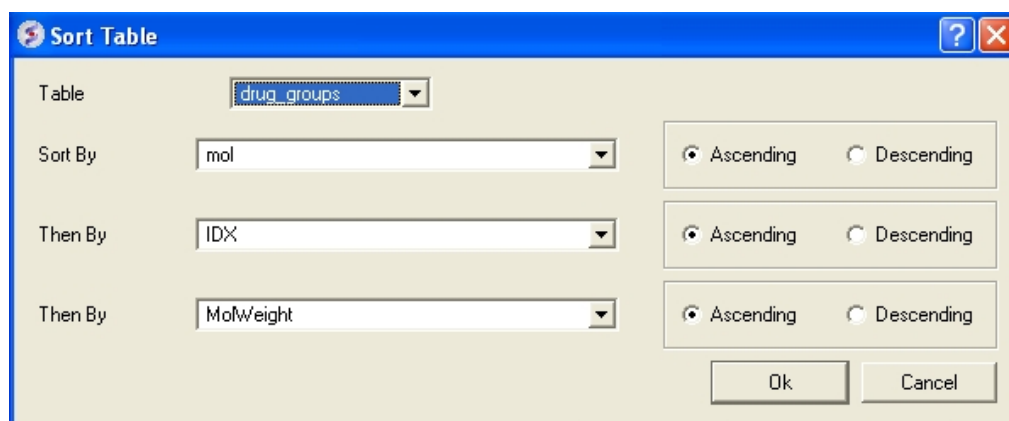

2.5.10.5 Merge Two Sets

To merge two tables:

- Read the two tables into ICM.
- Tools/Table/Merge Two Sets
- Select the first table from the drop down list (Table A) and the column you wish to use to merge the table by.
- Select merge method 1. **inner** - only molecules present in BOTH A and B tables are kept; or 2. **left** ALL rows of A are kept ; or 3. **right** ALL rows of B are kept.
- Select the second table from the drop down list (Table B) and the column you wish to use to mergethe table by.
- Enter a name for the output table.
- Click OK and a new table will be displayed.

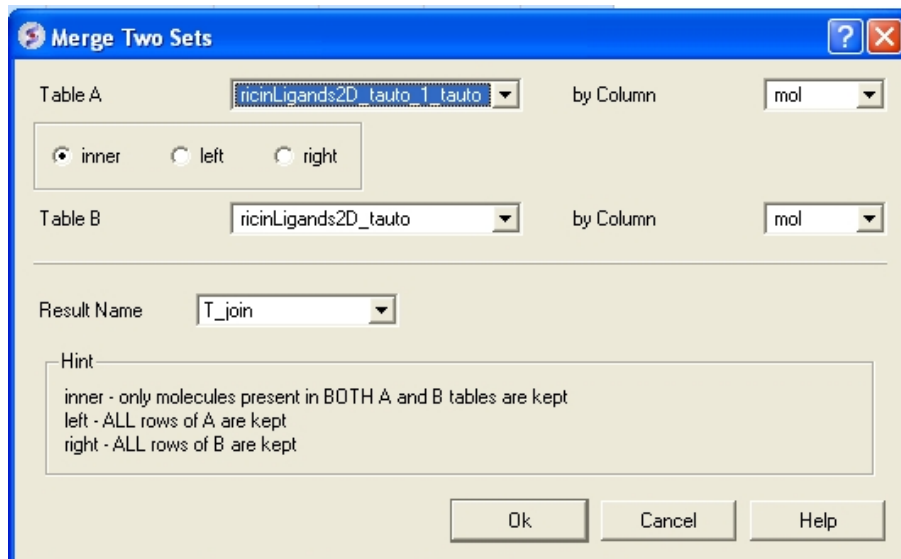

2.5.10.6 Add External Columns

To add external columns to a table (e.g. based on a merging key):

- Read at least two tables into ICM - the table you want to add to and the table you want to add the column from.
- Tools/Table/Add External Columns
- Enter the target table name and the column you wish to match each table by.
- Enter the source of the new column (Other table and column name)
- Choose to add "all the columns" from the source or "overwrite matching columns" or select the columns you want to add by selecting the "choose column" option.
- Select the columns you wish to add.

2.5.10.7 Append Rows

To append rows from one table to another one:

- Read at least two tables into ICM - the table you want to add to and the table you want to add the column from.
- Tools/Table/Append Rows
- Enter the name of the Target Table (where you will append).
- Enter the name of the Source Table (where you will append from).
- Select whether to Merge Columns
- Check whether you would like to **Select New Rows**. If you do this you can easily highlight the new rows using the mark row option.
- Check whether you would like to **Calculate Columns with Formulas**.

2.5.11 Tools Menu - Chemical Search

Chemical searching is described in the Chemistry chapter here.

2.5.12 Tools Menu - Molecular Editor

The molecular editor is described in the Chemistry chapter here.

2.5.13 Homology Menu

The options in this menu are described in the Homology Modeling Chapter.

2.5.14 Chemistry Menu

The tools in the **Chemistry** menu are described here.

2.5.15 Docking Menu

The tools in the **Docking** menu are described in the Docking chapter.

2.5.16 MolMechanics Menu

The options in this menu are described in the Molecular Mechanics chapter.

2.5.17 Windows Menu

This menu allows you to choose the windows you wish to display. The windows which open automatically when you first open GUI are shown in the *Getting Started* section. Other windows can be displayed by selecting the windows menu. For example, if you have loaded a table but cannot see it in the GUI it may be because the Tables option in the window menu hasnt been selected.

To add or remove windows from the GUI display select the 'window menu'. Other windows not included in the default display such as tables and alignments can be added.

I have windows open everywhere - Please bring some order.

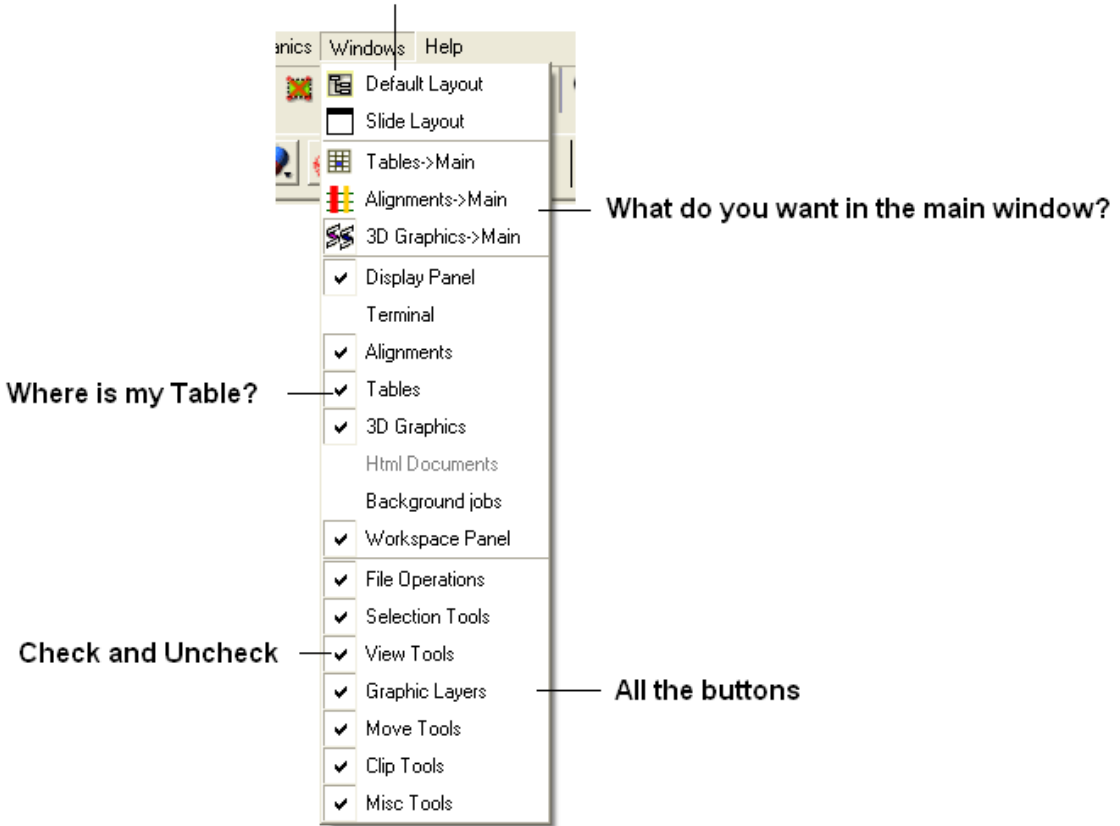

To return to the default display option select the 'Default layout' option in the windows menu.

OR

Click the default layout icon.



2.6 Tab Guide

In this section we describe the contents of the tabs in the graphical user interface.

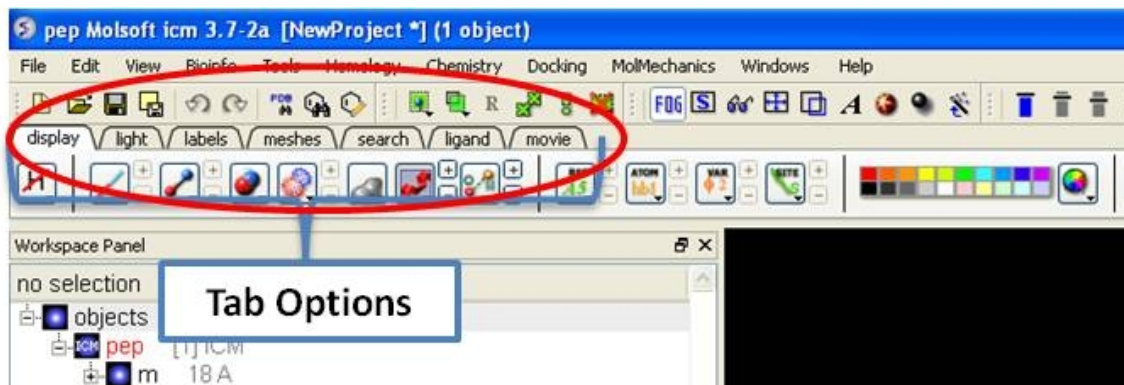

2.6.1 Display Tab

The display tab contains tools for a variety of functions including - structural representations, coloring, labeling and superposition. This tab is shown below.



2.6.2 Light Tab

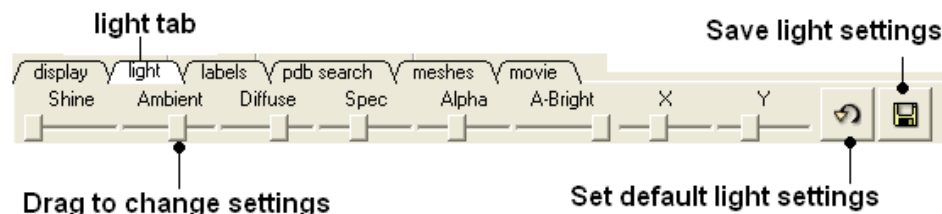

The options in this tab are described in the Lighting Section.

2.6.3 Labels Tab

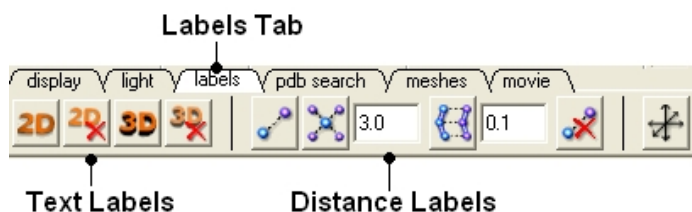

The options in this tab are described in the labels section of this manual.

2.6.4 PDB Search Tab

Instructions on how to use this tab can be found in the Search PDB section.

2.6.5 Ligedit Tab

Instructions on how to use the options in this tab can be found in the How to use the 3D Interactive Ligand Editor section.

2.6.6 Meshes Tab

Click on the tab button entitled '**meshes**' and three different graphical display tools are available for you to use. The three displays are surface, meshes and macroshape and are collectively referred to as meshes.

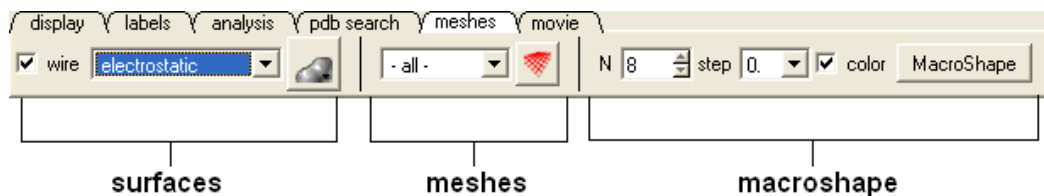

The benefits and applications of each display are described in the section.

3 Getting Started

Chapter Contents:

- The Basics of the Graphical User Interface
- How to search and Download Protein Structure, Sequences, and Chemicals
- How to create new Objects
- How to open files
- How to save files
- How to Make Selections
- Changing Preferences

3.1 The Basics of the Graphical User Interface

Available in the following product(s): ICM-Browser | ICM-Browser-Pro | ICM-Pro | ICM-Chemist

3.1.1 The Components of the GUI

The **Graphical User Interface** (GUI) has many components. When you first use the GUI the default window layout is displayed as shown below.

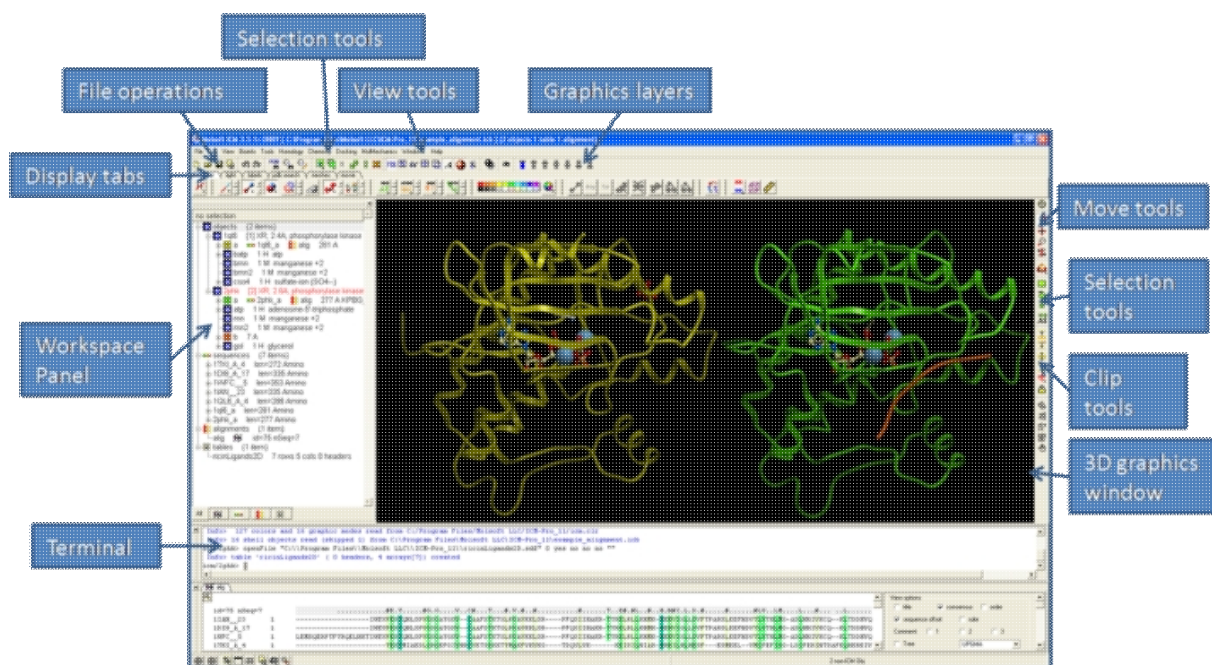

3.1.2 How to load a PDB Structure

There are three main ways to read in a PDB file.

1. Using the command line.
2. Using File/Open button
3. Using the PDB Search tab

Other PDB search options are described in more detail in the PDB Search section of this manual.

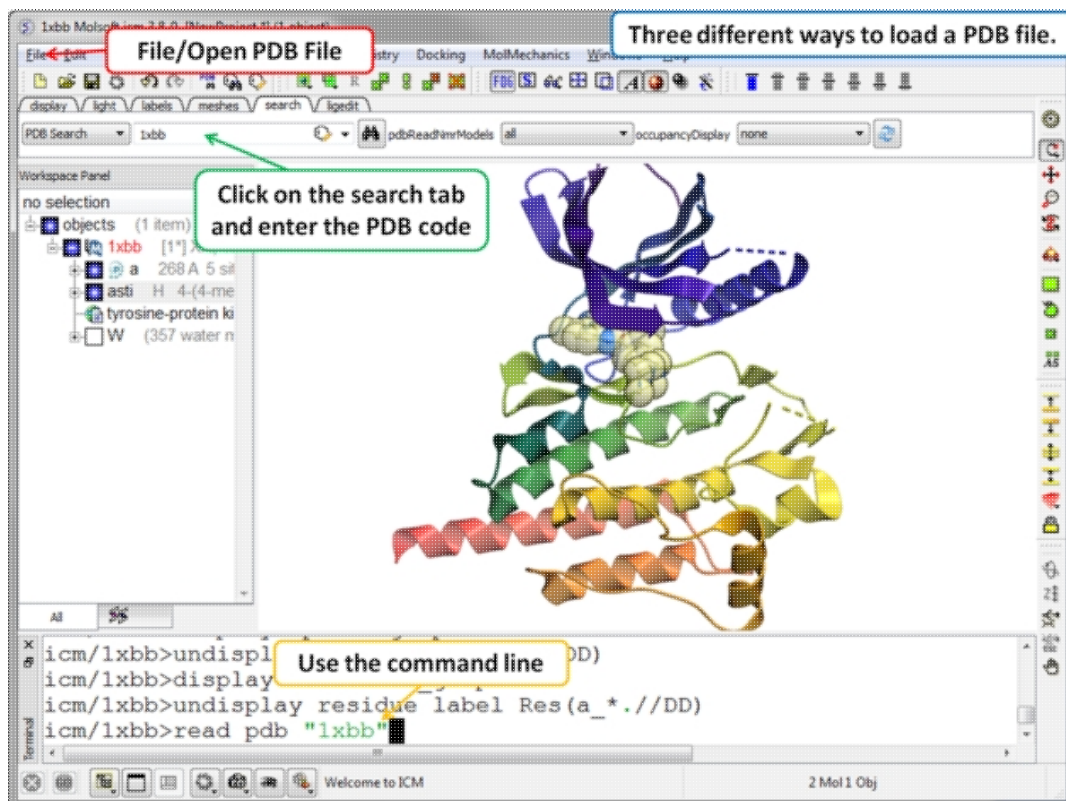

3.1.3 How to Move a Structure in the Graphical Display

Available buttons and options for moving molecules around the graphical display window. This is described in more detail in the section entitled Move Buttons.

center

translation rotation mode

Z-axis zoom

auto rock/rotation

GUI Molecule Move Buttons

3D Window "Hot Zones"
 When Cursor is on "Rotation Mode"

Middle button

move = translation

Right button

move = selection
(markers appear);
select empty zones
to remove
selection

Left button

move = rotation

up/down = zoom in/out

up/down = zoom in/out

up/down = clip back plane

up/down = clip back+front planes

up/down = clip front plane

clicking + holding

How to use the Graphics window controls

In the graphics window you can use various `tools` described elsewhere but it is helpful to know the following things:

- **Picking a tool:** the left mouse button will function according to the selected tool
- **Popup menus:** right click on an atom gives a pop-up menu
- **Selecting in the rotation mode:** the right mouse button will select atoms
- **Translating in the rotation mode:** the middle mouse button will translate the scene
- **Zooming and moving clipping planes in the rotation mode:** the left, top and right margins of the graphics window are reserved for other actions, zoom, z-rotation, and clipping planes, respectively. That means that even if you are picking atoms, by pressing control you can still rotate your molecule with the left-mouse-button.
- **Rotating in any non-rotation mode:** if you press **Control** in any mouse mode, e.g. zoom, pick etc., it will temporarily switch to **rotation**
- **Escaping from the connect and continuous movement modes:** pressing **Escape** helps to get out of certain modes, such as Full Screen, Continuous rotation or rocking, the Connect mode.
- **Global rotation in the Connected mode:** pressing **Shift** will temporarily switch to the global rotation/translation mode.

3.1.4 How to Display Molecules using the ICM Workspace Panel

The workspace panel (located on the left hand side panel of the gui) is an important place within the graphical user interface because it displays which sequences, structures, objects, tables and alignments are currently loaded into ICM. From the ICM Workspace panel you can make graphical selections and display and undisplay molecules.

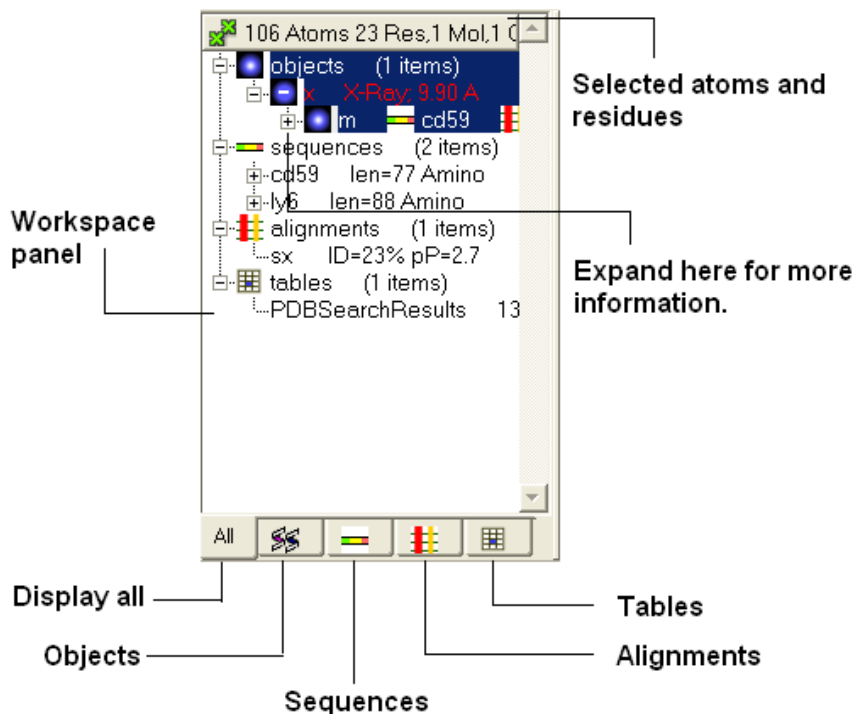

Once a structure has been loaded into ICM the individual components of that structure (i.e. amino acids, metal ions, binding sites etc) are listed in the ICM workspace.

To display every component of the object except for binding sites and water atoms:

- Click on the white box next to the word object at the top of the ICM workspace. This box will be colored blue once the structure is displayed

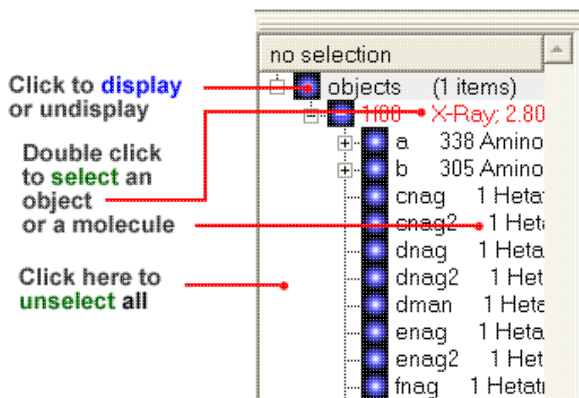

To display the whole structure in wire, ribbon, cpk, skin, surface and xstick representations:

- Right click on the blue box next to the word object. A menu will be displayed.

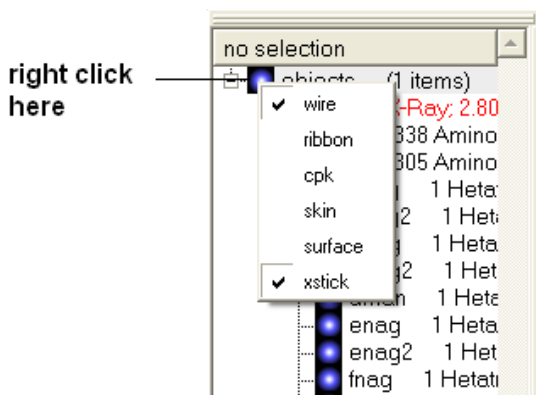

- Select which representation you desire for your structure by clicking on the appropriate word. A check mark indicates the representation currently displayed. To un-display a particular representation click on the word again.

In order to clear your graphical display:

- Select **View/Undisplay All**

If you only wish to display part of the structure then click in the boxes further down the tree in the ICM workspace.

To display selected regions of the molecule in wire, ribbon, cpk, skin, surface and xstick representations:

- Right click on the appropriate box in the **ICM** workspace. A menu will be displayed and select the representation you would like to use (e.g. wire, ribbon etc...)

3.1.5 How to Make Selections

Making selections in ICM is an important skill to master (e.g. you may want to select a binding pocket for docking or a region of a molecule for coloring). The four levels of selection are:

1. Atoms
2. Residues
3. Molecules
4. Objects (multiple molecules comprising a PDB entry)

There are several ways of making selection in ICM. The simplest is to interact directly with the graphics window - **right-click, hold and drag** around the area of the screen you want to select. Alternatively, in the workspace window, expand the tree of molecules and chains until the relevant protein sequences is displayed. Then left click and drag to mark residues to form a selection.

See the chapter entitled Making Selections for more information.

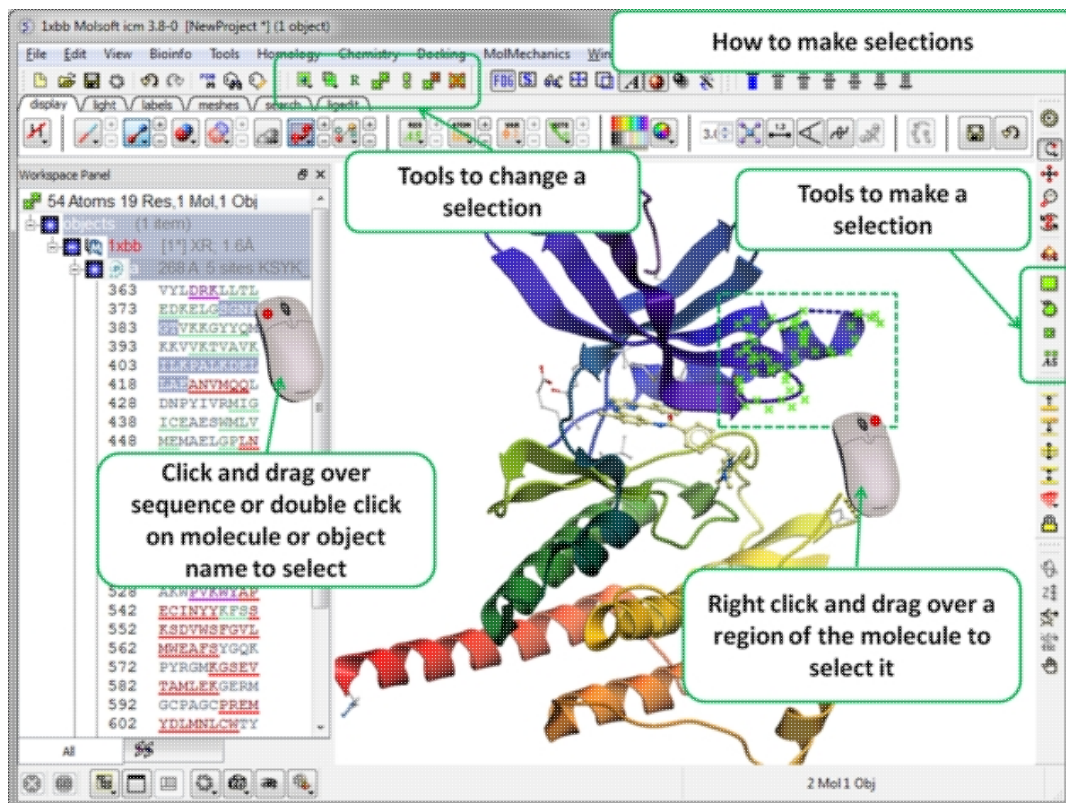

3.1.6 How to Change Protein Representation

To change the representation of the protein, make a selection and then use the tools in the display tab.

There are 6 main types of representation:

- **Wire:** Wires connecting covalently bound atoms of a molecule. This representation has no defined thickness as such will not make shadows. Useful for showing the chemical structure of a small molecule.
- **Xstick:** Covalent bonds are represented as cylinders whilst atoms are represented as small spheres.
- **CPK:** Atoms are represented as spheres with their respective van der Waals radius and coloured according to a standard defined by Corey, Pauling and Kuntun.
- **Surface:** Solvent accessible surface. This is the center of water sphere as a water probe rolls over the molecule.
- **Skin:** A Connolly molecular surface over the selection. This is a smooth envelope touching the van der Waals surface of atoms as a water probe rolls over the molecule.
- **Ribbons:** Cartoon representation of protein and DNA secondary structure. Protein residues marked as alpha-helices ('H') are shown as a flat, helical ribbon, those marked as beta-sheets ('E') are shown as a flat ribbon with an arrow-head, and the rest are shown as a cylindrical "worm". If secondary elements are not defined everything will be shown as a cylindrical worm. ICM can automatically assign secondary structure: Tools/3D predict /Assign Helices and Strands

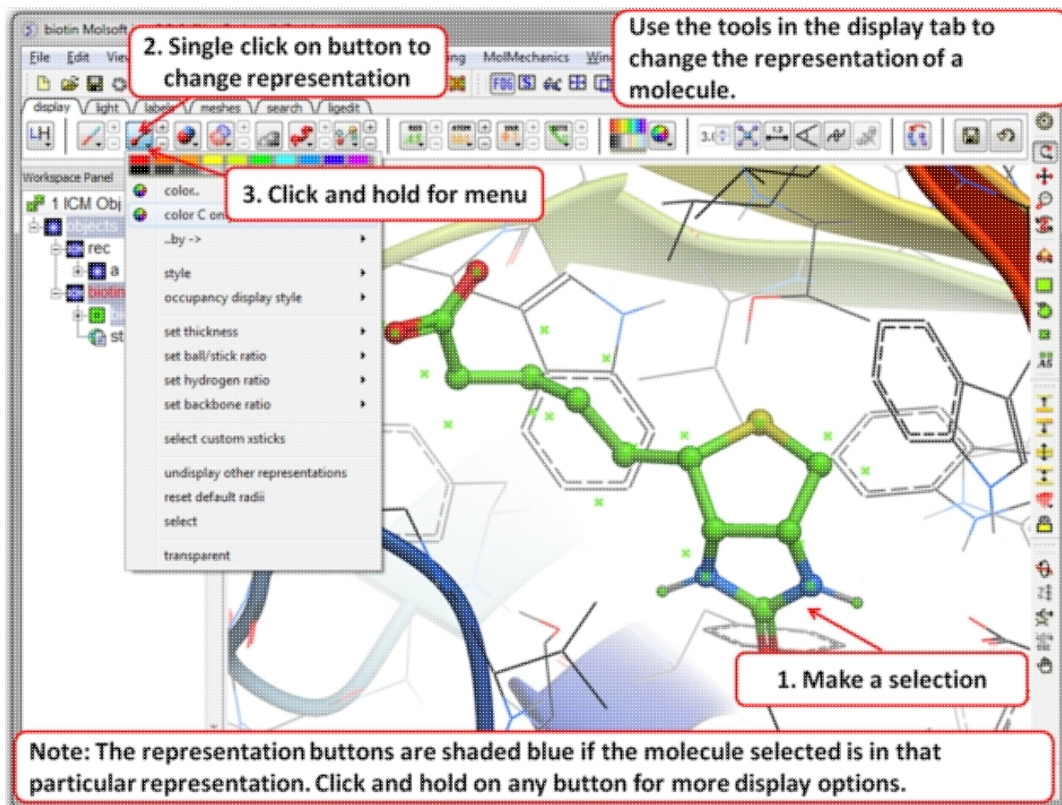

3.1.7 How to Color

To change the color of the representation you need to use the buttons in the `display` tab.

Changing the colour of a representation works in much the same way as displaying the representation itself. The selection rationale is the same followed by clicking on a colour in the palette in the `display` tab. It is also possible to colour different representations of the same selection independently by clicking and holding on the representation buttons in the `display` tab.

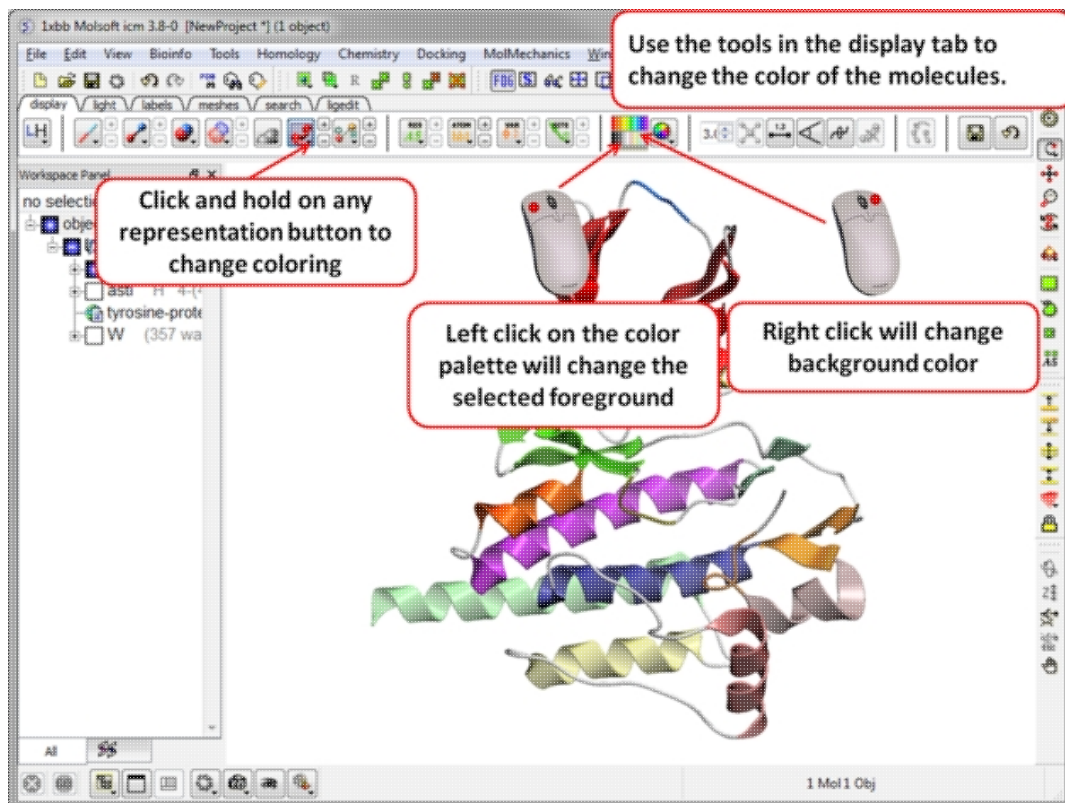

3.1.8 How to Display a Binding Pocket Surface

To display the surface of a small molecule ligand or peptide binding pocket:

- Load the PDB of interest.
- Convert PDB to ICM object. If you do not convert you will not get the properties of the pocket displayed on the surface.
- Right click on the small molecule or peptide in the ICM Workspace and select **Ligand Pocket**.

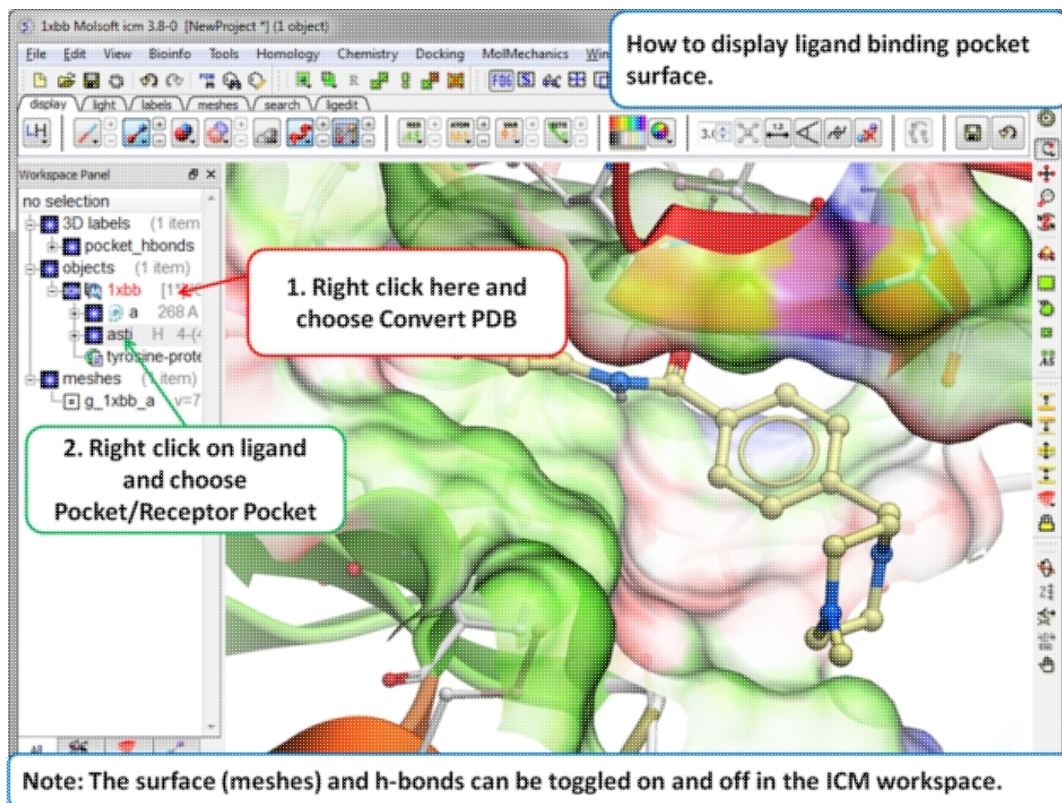

3.1.9 How to Save an ICM Object

Any ICM object such as a structure, sequence, or alignment, can be saved for use at a later time.

To save an object:

- Right click on the object name in the ICM workspace or ICM alignment editor and a menu will be displayed.
- Click on the **Save As...** option.
- Enter the unique name you wish to call your object in the box labeled **File name:**
- Choose which folder or directory you wish to save your object by clicking scrolling down in the box labeled **Save in:**
- Choose which file type you would like to save your object as by scrolling down in the box labeled **Save as type**. ICM structure objects should have the file ending yourfilename.ob and alignments yourfilename.ali
- Once the appropriate information has been entered click on the **Save** button in the bottom right hand section of the window.
- The object is now saved.

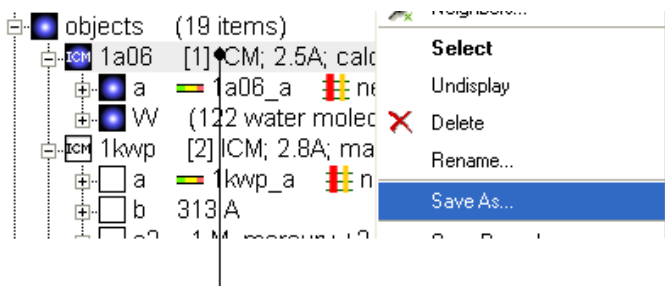

To save an ICM object or PDB file right click and select SaveAs..

3.1.10 How to Save an ICM Project File

All objects contained within an ICM session can be saved in a single file with the extension .icb. The file can then be read into ICM and the exact layout of the file will be preserved. To save a project file go to the **File** menu and select **Save Project**.

3.1.11 How to Drag and Drop

NOTE: "Drag and Drop" is a useful way of moving objects and sequences around the graphical user interface.

Sequences and objects can be moved around the graphical user interface by dragging and dropping them. All loaded sequences and objects are always displayed in the workspace panel. Select the desired object or sequence from the workspace panel by clicking and holding, move the selection to the desired location and release.

This is a useful application in the graphical user interface. For example, you may have an alignment displayed and you wish to add another sequence to the alignment. This can simply be accomplished by dragging a loaded sequence from the workspace panel into the alignment display panel. Or, you can quickly view an object by dragging and dropping it from the workspace panel into the 3D graphics window.

3.1.12 How to: Right Click Options

NOTE: If you right click on any object you will see a new menu of options related to that object.

The right click mouse option can be used throughout the graphical user interface. It is a very useful means of opening up a whole new world of menus and options. Most of these options are described in this book. However, when using the graphical user interface it is always a good idea to try right clicking the mouse on an object and seeing which extra options that are available for you to use.

3.1.13 How to Move Windows

Is your graphical user interface looking a bit messy? Do you have tables, alignments, plots all over the place? Here we show you how to arrange everything to make a clearer GUI environment.

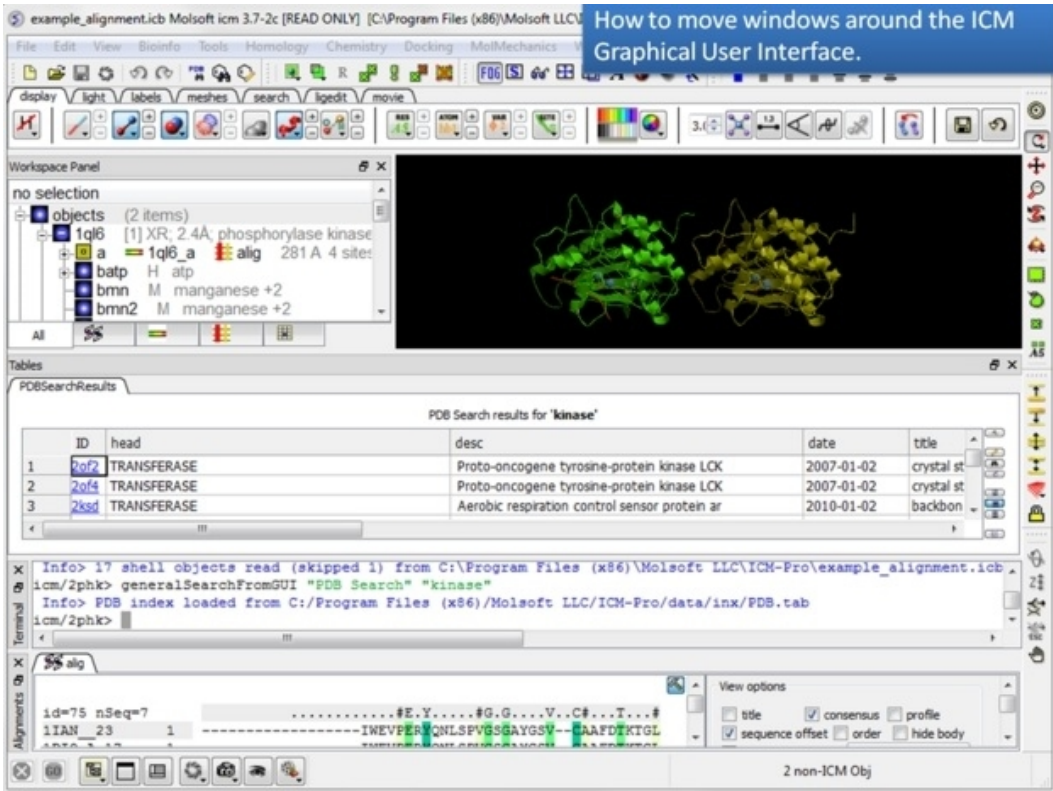

1. Too many windows in your GUI? You can move them around to make viewing easier.

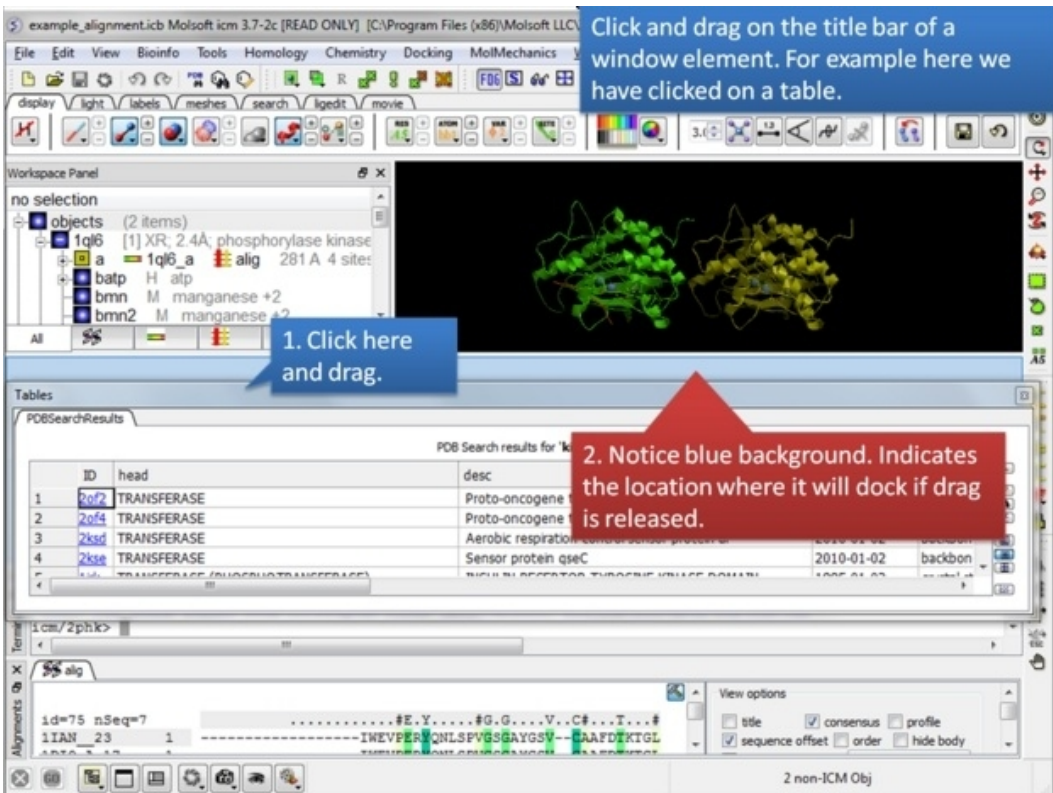

2. Click and drag on a window title bar to move it.

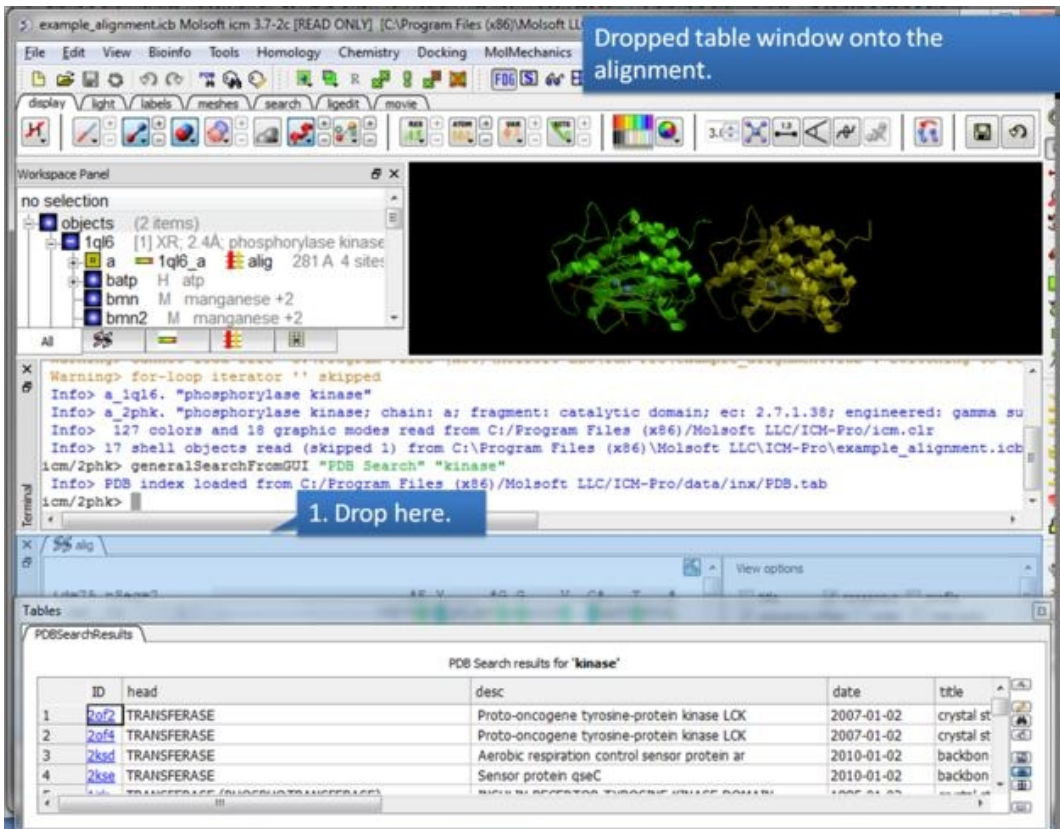

3. Drop one window on another one to dock it.

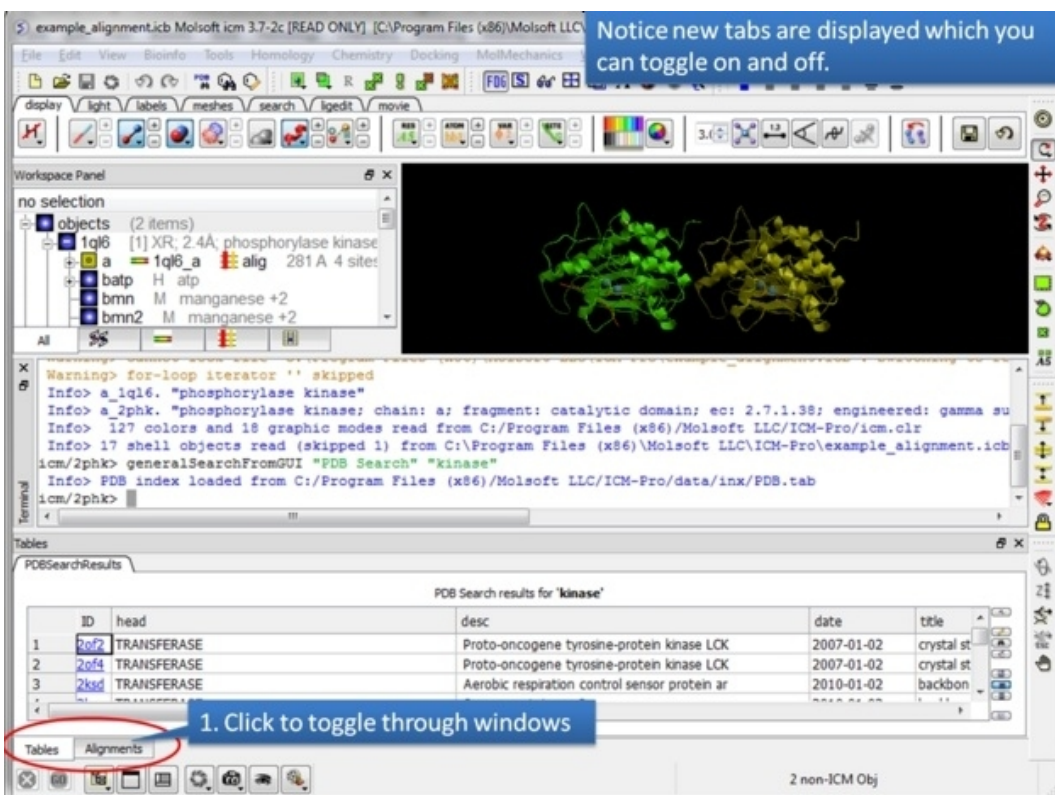

4. You can access each window by clicking on the tabs.

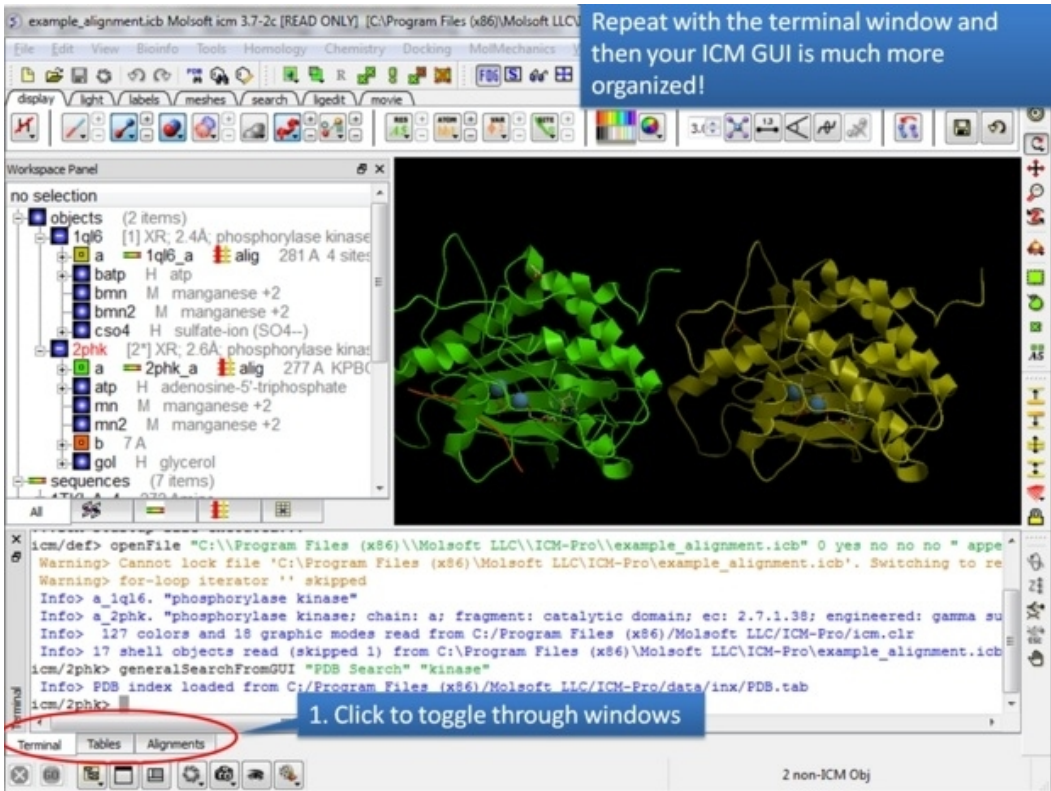

5. In this example we have the table, alignment, and terminal all in the same panel

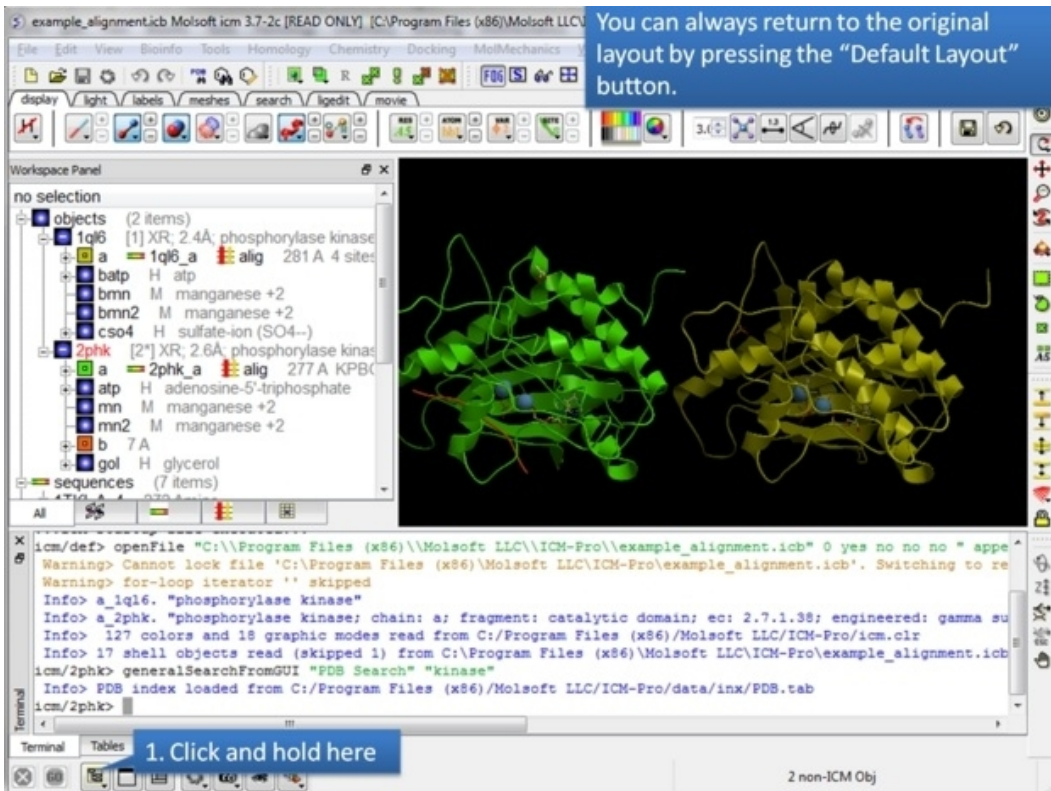

6. There is a quick way to return the windows to their original location.

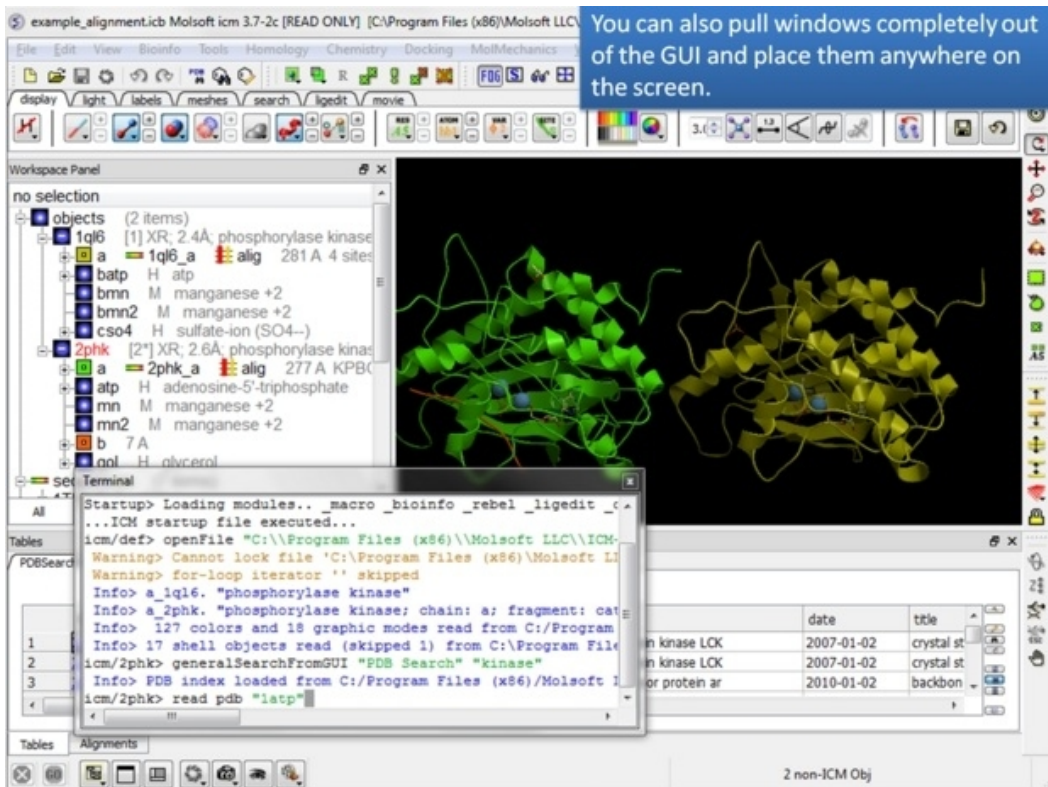

7. You can also move a window to any part of your screen.

NOTE: To return to the default display option select the 'Default layout' option in the windows menu.

OR

Click the default layout icon.

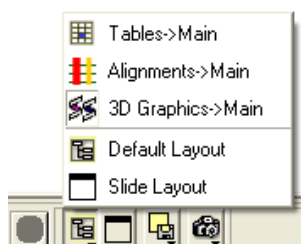

Some options can be accessed at the bottom of the GUI.

OR

Double click on the window header.

3.1.13.1 How to Arrange Windows

Sometimes when using ICM you may have many items displayed such as structures, alignments and tables. As a default the graphical display is the largest and centered in the middle of the ICM graphical user interface. However if you wish to work on an alignment or table you can place the alignment or table as the main display by clicking on the buttons shown below. The larger display generally makes it easier to manipulate the alignment or table. There are ofcourse other ways to alter the layout such as tier the windows but this option is just a simple click and can sometimes come in useful.

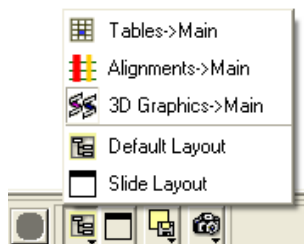

3.1.14 How to Make a Picture

There are several ways of taking a picture of the contents of the 3D graphical display window see the write image section. However the easiest way is to simply click on the button in the view tools panel (see image below).

quick high quality image

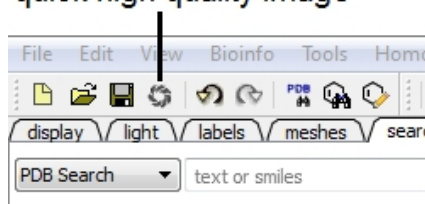

Or select /File/Quick Image

The picture will be automatically saved as a PNG file in the directory from which you loaded ICM. The default picture name is icm[n].png, where n is the number of pictures taken in one ICM session. To save in other picture formats and to change the file name see the write image section.

3.2 How to search and download Protein Structure, Sequences, and Chemicals

Available in the following product(s): ICM-Browser | ICM-Browser-Pro | ICM-Pro | ICM-Chemist

The **Search** tab allows you to search and download content from the following databases:

- The Protein Databank www.wwpdb.org - search for protein and chemical
- The Pocketome Database <http://pocketome.org/>
- BLAST search the NCBI sequence database
- The UniProt Sequence database <http://www.uniprot.org/>
- Search the PDB by ligand code.
- Search Drug Bank <http://www.drugbank.ca/>
- Search PubChem <https://pubchem.ncbi.nlm.nih.gov/>
- Search ChEMBL <https://www.ebi.ac.uk/chembl/>
- Search SureChEMBL <https://www.surechembl.org/search/>
- Search the Crystallography Open Database <http://www.crystallography.net/>

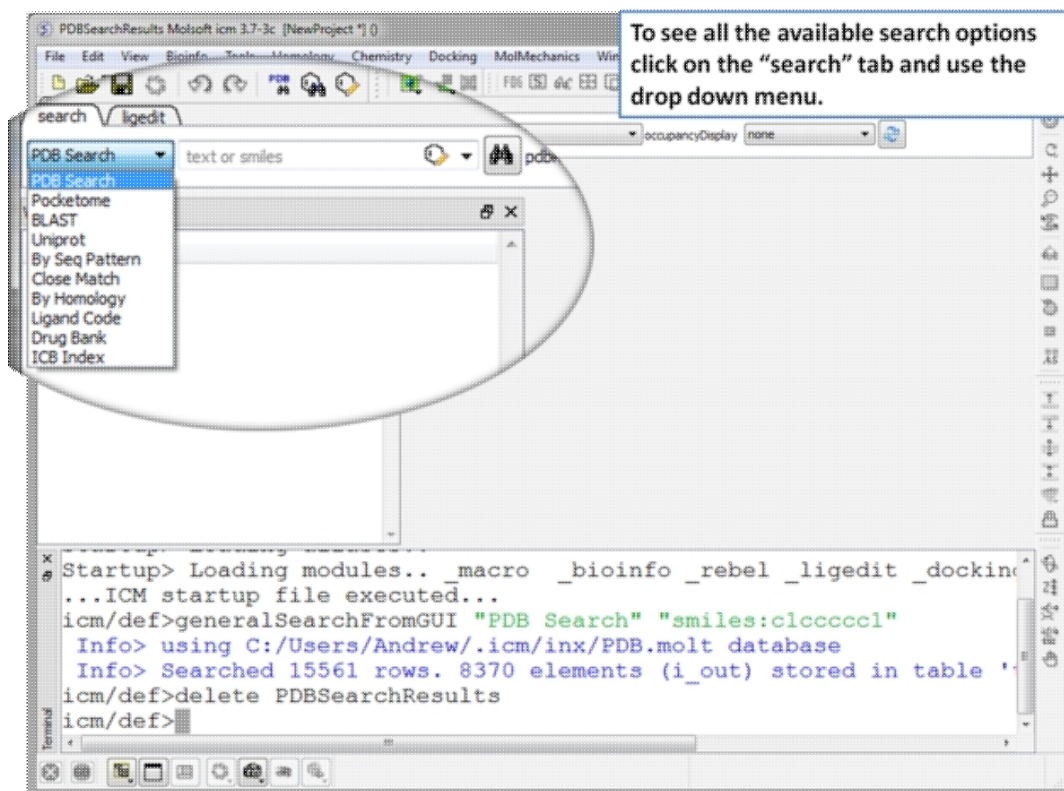

Click on the search tab and then use the drop down menu to identify the database you would like to search and download from.

3.2.1 Search the PDB

How to Search the Protein Databank and Download

The **PDB search tab** provides easy access to the PDB database. You can use keyword searching or type in the PDB code you are interested in. An asterisk (*) wildcard can be used to list all the pdb files currently available in the protein databank. Different fields can be searched by using the drop down arrow as shown below. More advanced PDB search tools and how to use the PDB search result table are described in the section entitled Searching the PDB.

Once a search is complete a table of PDB files relating to your search query will be displayed. To view the PDB file in 3D in the graphical display double click on a row in the PDBSearchResults table.

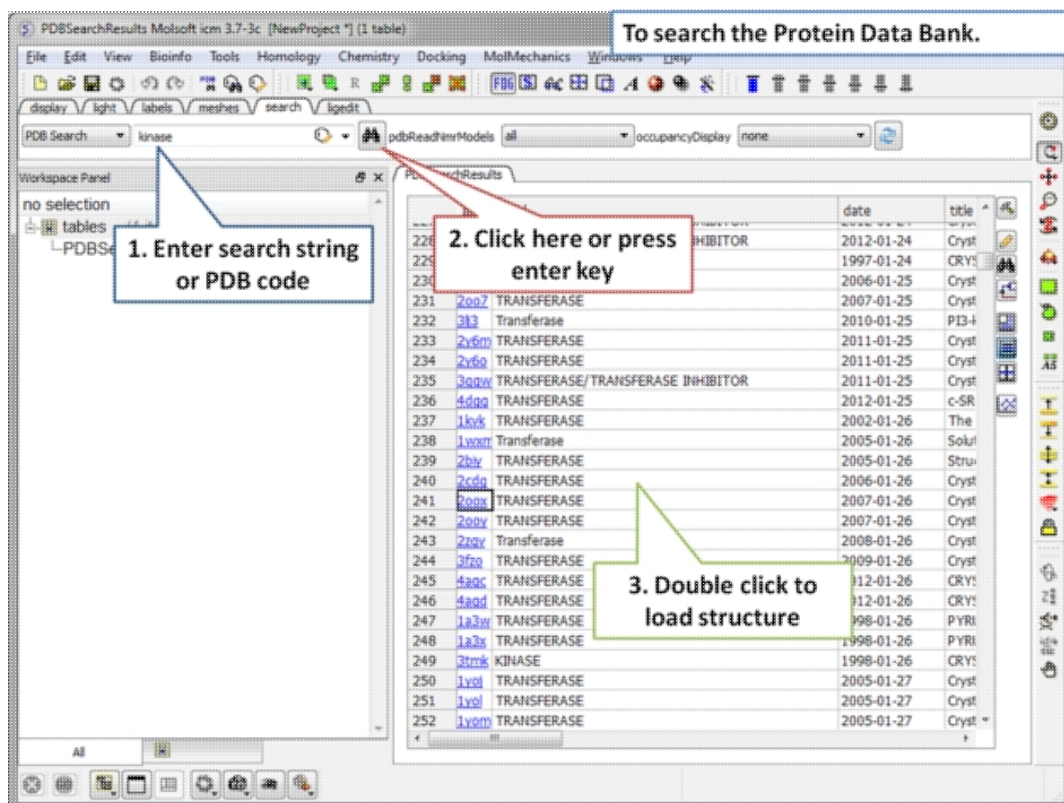

To Search the PDB and Download a Structure:

- Click on the search tab and enter a search string or PDB code.
- A table containing the results will be displayed.
- Double click on a row to load the PDB file. Read more about PDB search here.

NOTE: If you have a PDB structure already saved you can read it into ICM by going to the File Menu and selecting Open. PDB files that have been viewed previously can be loaded using File/ Recent PDB Codes.

3.2.1.1 How to Search the Protein Databank by Chemical Substructure

To search the Protein Data Bank by chemical substructure.

1. Click on the molecule editor button

2. Sketch the substructure

3. Close the window

4. Click here or press enter key

1	Formular
2	Smiles
3	ILPAC
4	InChI
5	InChIKey
6	MolWeight
7	HBA
8	HBD
9	RotB
10	DrugLikeness
11	MolArea
12	MolDf
13	MolLogP
14	MolLogS
15	MolPSA
16	Volume
17	Bad Groups
18	Groups

Step 1: Click on the molecule editor button inside the search tab. Sketch the substructure you are interested in.

Double click on the table to load the PDB structure.

1. Double click to load PDB structure

HETID	mol	ID	date	head
VHL		2zhc	2005-07-27	LYASE
VHL		1xt	2004-09-30	LYASE
2PB				HYDROLASE

Step 2: A table containing the results will be displayed. Double click on a row to load the PDB file.

3.2.1.2 How to Query the PDB by Sequence

There are a number of ways to search the PDB by sequences.

1. BLAST search the NCBI database using the option "Sequences from PDB".
2. Search by **Sequence Pattern** using the option in the Edit menu.
3. Search by **Identity** using the option in the Edit menu.
4. Search by **Homology** using the option in the Edit menu.

3.2.1.3 How to Query PDB by PDB Field

To query the PDB by field (Author, Compound, PDB Header, Experiment Type, Resolution or Ligand Code

- Select **Edit/PDB** search by field.
- Enter the search string or value
- Click **OK** and a list of related PDB entries based on your search will be displayed in the PDBSearchResults table of the graphical user interface.

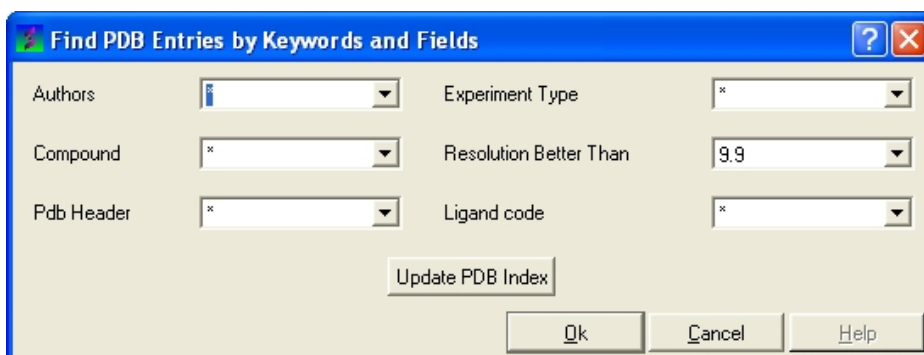

3.2.1.4 Load and Display NMR Structures

Use the PDB Search tab to load NMR structures from the PDB. You can use the drop down button shown below to determine how you want to display your NMR structure. You can choose to display and download the first NMR model, all models in the PDB file or all models in the PDB in a stack. If you choose the stack option the the stack will be stored in the object as described here.



Click for drop down m

3.2.1.5 Occupancy Display

You can use the options in the PDB Search tab to control if and how the partial or zero atom occupancies are displayed. You can choose to circle or label the poor occupancy atoms.



>>load-pdb-hyperlinks{pdb search hyperlinks} h4-- Hyperlinks to PDB Website and UniProt {Hyperlinks to Databases}

In the PDB Search Results Table you will see blue hyperlinks that will take you directly to the PDB website or Uniprot website.

3.2.1.6 Display PDB Header

To display the PDB Header for a PDB file.

- First load a PDB file into ICM (see Search PDB)
- Double click on the word header in the ICM Workspace.

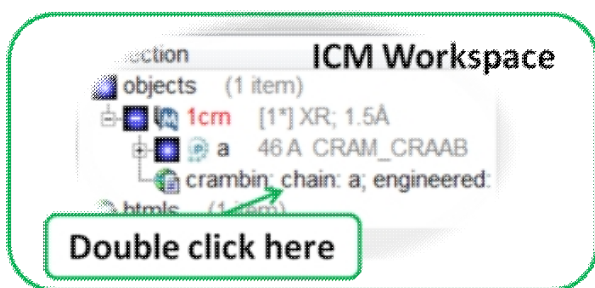

- The PDB Header information will be displayed.
- Click on the blue hyperlinked text to link to external web pages for additional information if needed.

3.2.1.7 Direct link to PubMed

When you search for a PDB file and load it into ICM you will see an icon (shown below) next to your protein name in the ICM Workspace. Click the icon and you will be taken directly to the PubMed primary reference relating to the structure.

Direct access to PubMed

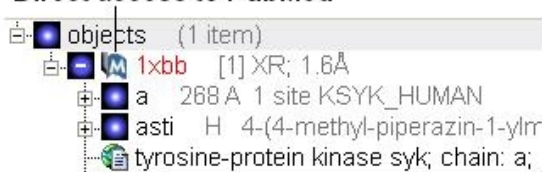

3.2.2 Search Pocketome

The Pocketome (www.pocketome.org) is an encyclopedia of conformational ensembles of all druggable binding sites that can be identified experimentally from co-crystal structures in the Protein Data Bank.

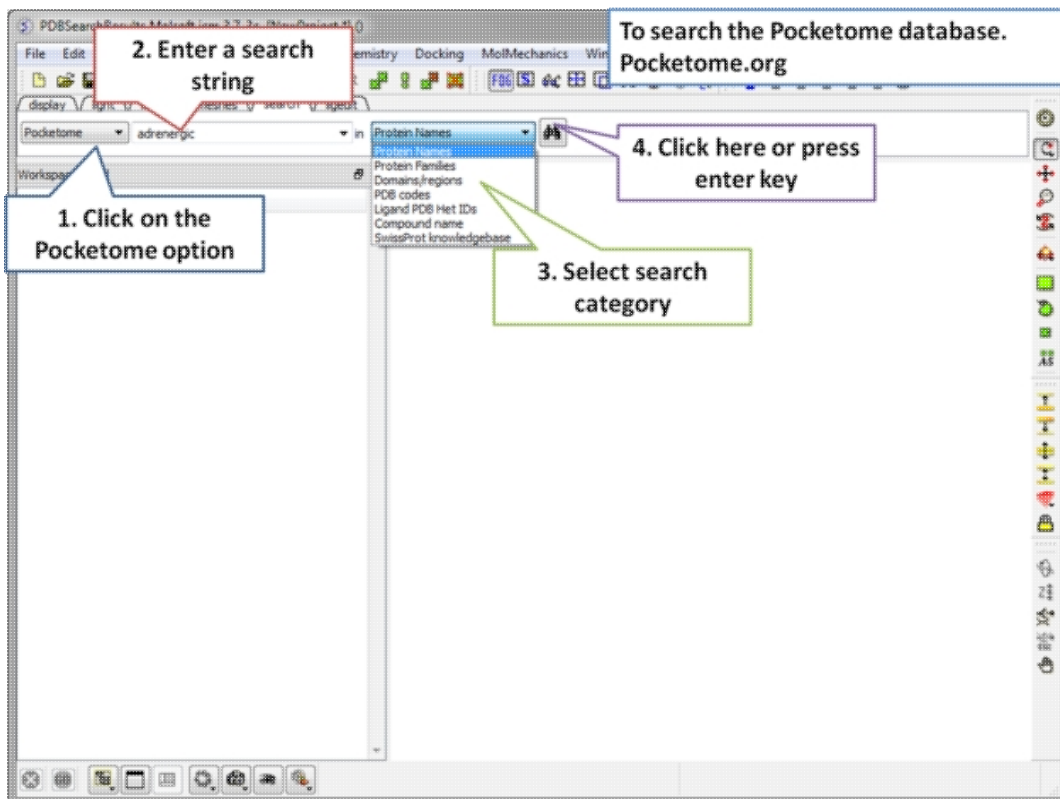

Step 1: Click on the search tab and choose the Pocketome option. Check a field you would like to search e.g. Protein Name, Family, domain...

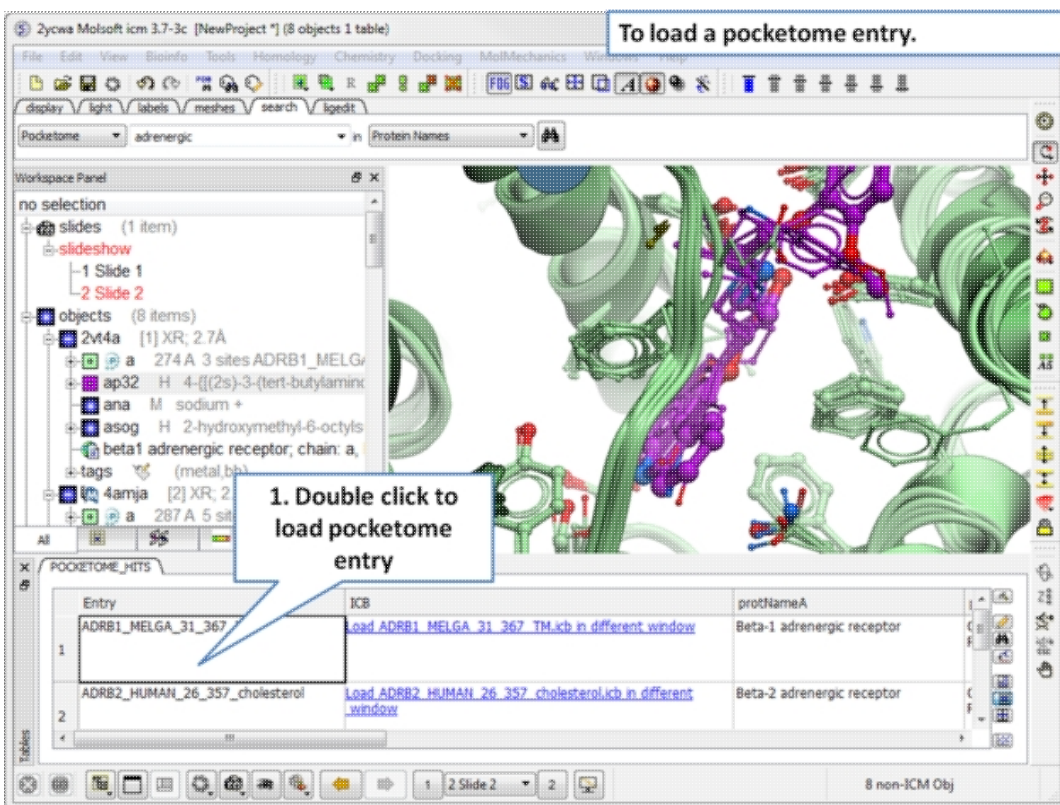

Step 2: A table of pocketome hits will be displayed. Browse the results and double click to load a pocketome entry.

3.2.3 ChEMBL Search

ChEMBL (<https://www.ebi.ac.uk/chembl/>) is a manually curated chemical database of bioactive molecules with drug-like properties. It is maintained by the European Bioinformatics Institute (EBI), of the European Molecular Biology Laboratory (EMBL), based at the Wellcome Trust Genome Campus, Hinxton, UK.

To search and download data from ChEMBL:

- Click on the **Search** tab.
- Choose ChEMBL from the drop down button.
- Enter a search string or search by chemical sketch by clicking on the editor button in the panel.
- Select a field to search e.g. Protein Name.
- Select whether you wish to return just activity data or all data.
- Click the search button.

A table will be displayed as shown below.

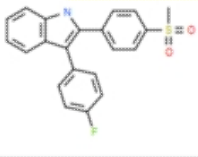
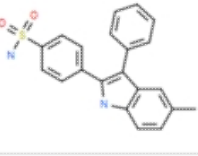
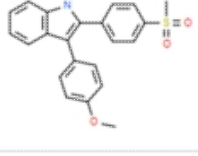
mol	chembl_id	synonyms	uniprot_id	fullname
	CHEMBL501208		PGH2_HUMAN	Prosta
	CHEMBL525247		PGH2_HUMAN	Prosta
	CHEMBL499069		PGH2_HUMAN	Prosta

The table contains the original activity data without merging or aggregation. For instance,

Chemical 1, Protein 1, Activity 1
Chemical 1, Protein 1, Activity 2
Chemical 1, Protein 2, Activity 1
Chemical 2, Protein 1, Activity 1

Click on the button **Get Best Activity** to display the best activity for each chemical, protein pair. For instance,

Chemical 1, Protein 1, Best(Activity 1, 2, 3, ...)
Chemical 1, Protein 2, Best(Activity 1, 2, 3, ...)
Chemical 2, Protein 1, Best(Activity 1, 2, 3, ...)

Click on the button **Get Ligand Summary** to display a list of chemicals with all activities found in ChEMBL. For instance,

Chemical 1, Protein 1, Activity 1

Protein 1, Activity 2

Protein 2, Activity 1

Protein 3, Activity 1

Chemical 2 Protein 1, Activity 1

Protein 2, Activity 1

Protein 2, Activity 2

3.2.4 Search SureChEMBL

SureChEMBL (<https://www.surechembl.org/search/>) provides free access to chemical data extracted from the patent literature. To search SureChEMBL:

- Click on the **Search** tab.
- Choose SureChEMBL from the drop down button.
- Enter a search string or search by chemical sketch by clicking on the editor button in the panel.
- Select a field to search e.g. Protein Name.
- Select whether you wish to return just activity data or all data.
- Click the search button.

3.2.5 BLAST Search

To BLAST search the NCBI sequence database:

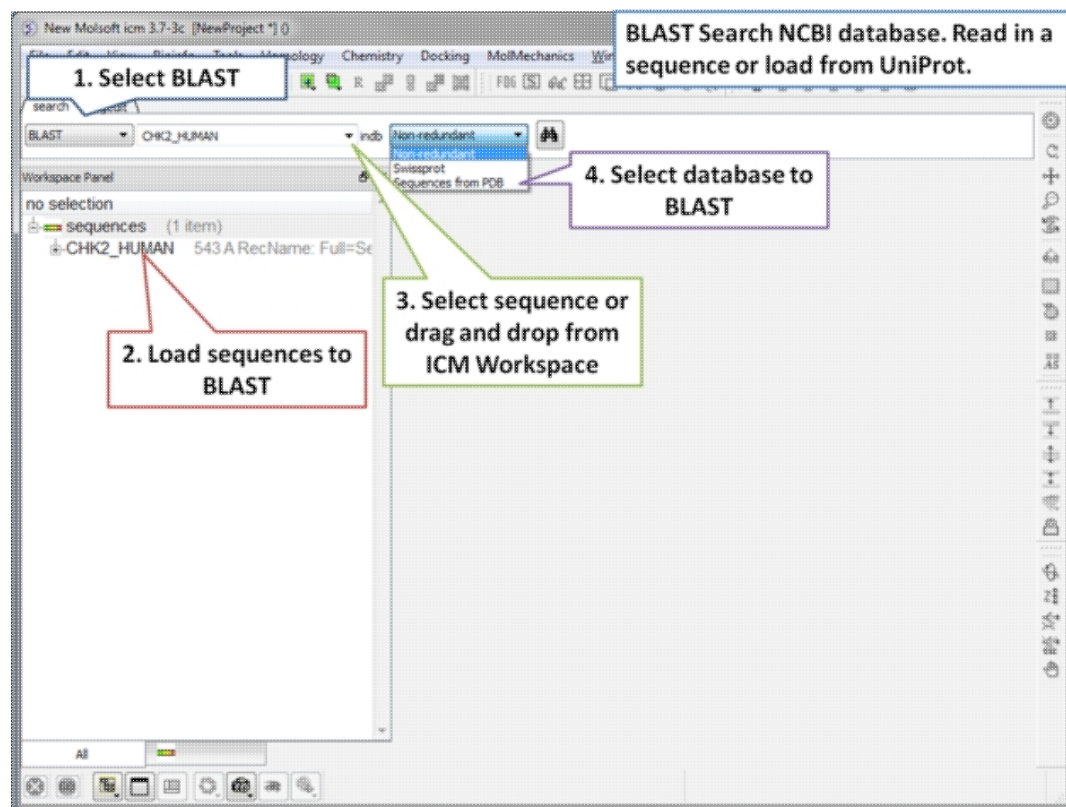

Step 1: Load a sequence into ICM. Select the Search tab and choose the BLAST option. Drag and drop the sequence into the search field, use the drop down menu or type the sequence name.

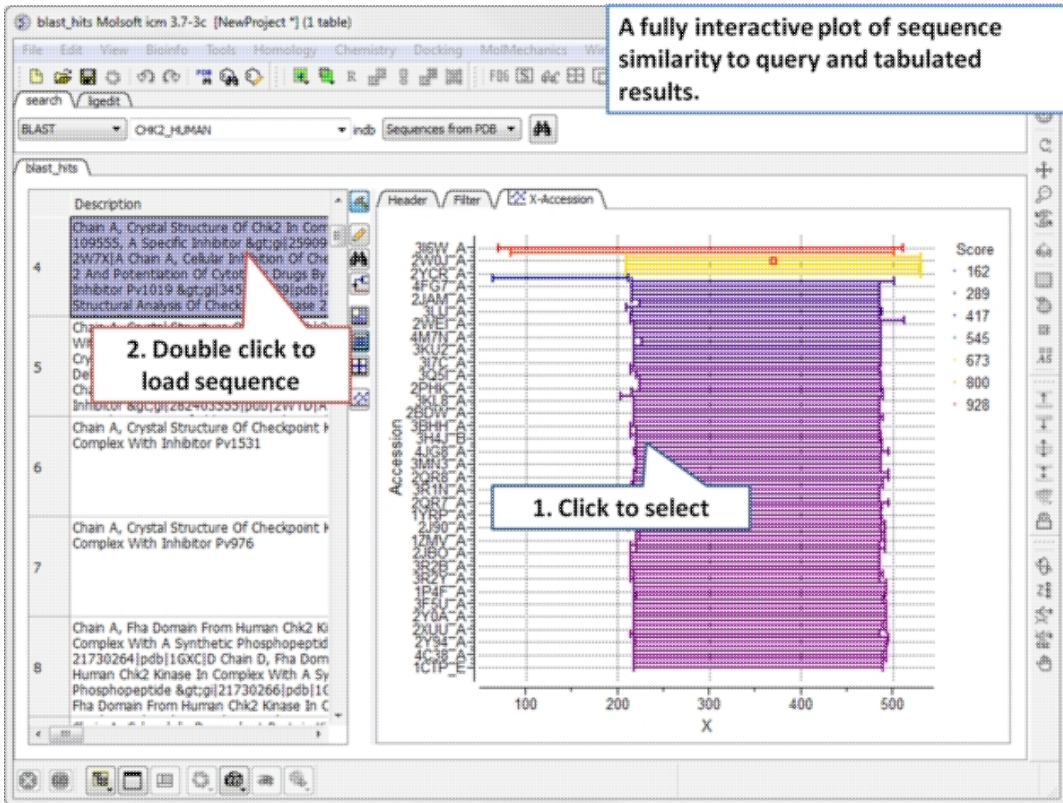

Step 2: A fully interactive table and plot of sequence conservation will be displayed. Double click to load a sequence.

3.2.6 Search UniProt

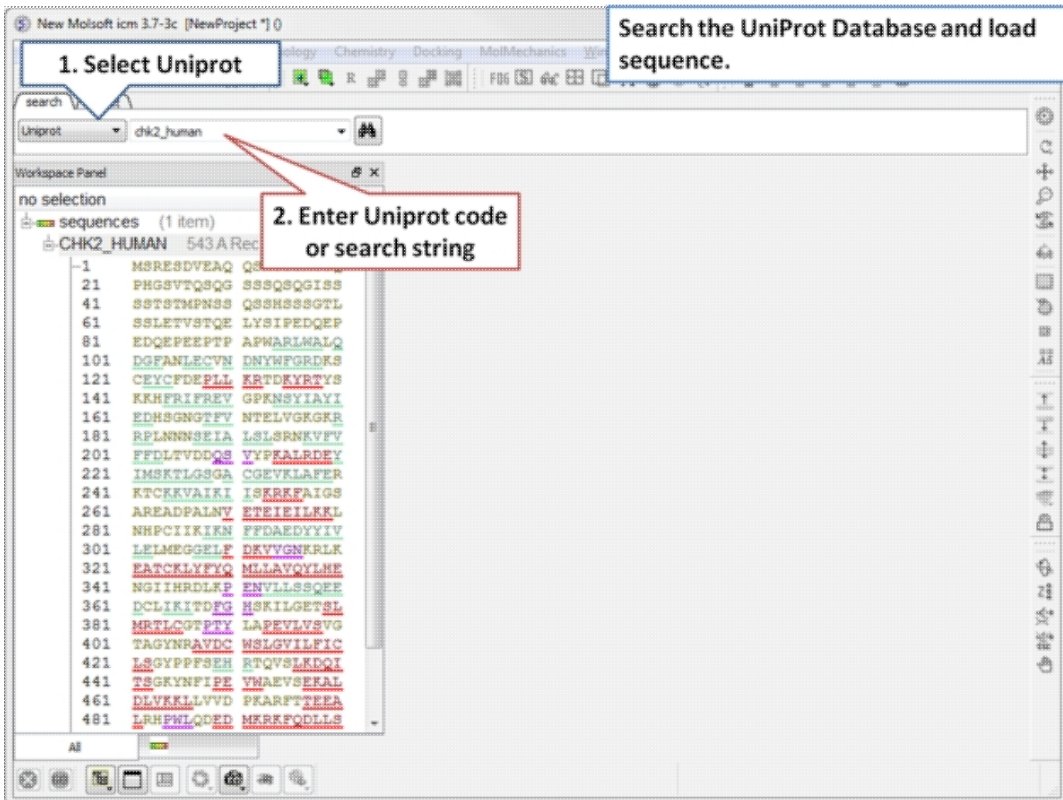

Step 1: Click on the search tab and select **Uniprot** from the drop down menu. Enter the UniProt code. The sequence will be loaded directly into ICM and you will see it in the ICM workspace.

3.2.7 Search PDB by Ligand Code

To find structures containing a particular ligand in the PDB.

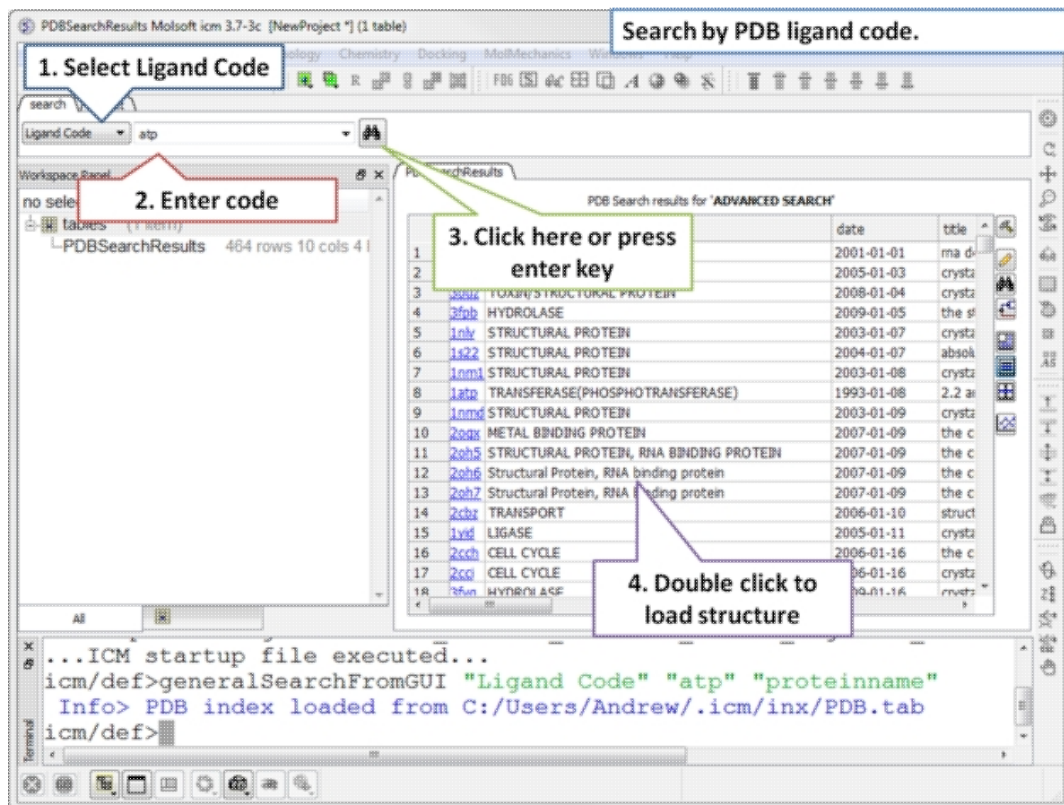

Step 1: Click on the search tab and select **Ligand Code** from the drop down menu. Enter the Ligand code and a table of hits will be displayed.

3.2.8 Search Drug Bank

To search Drug Bank (<http://www.drugbank.ca/>)

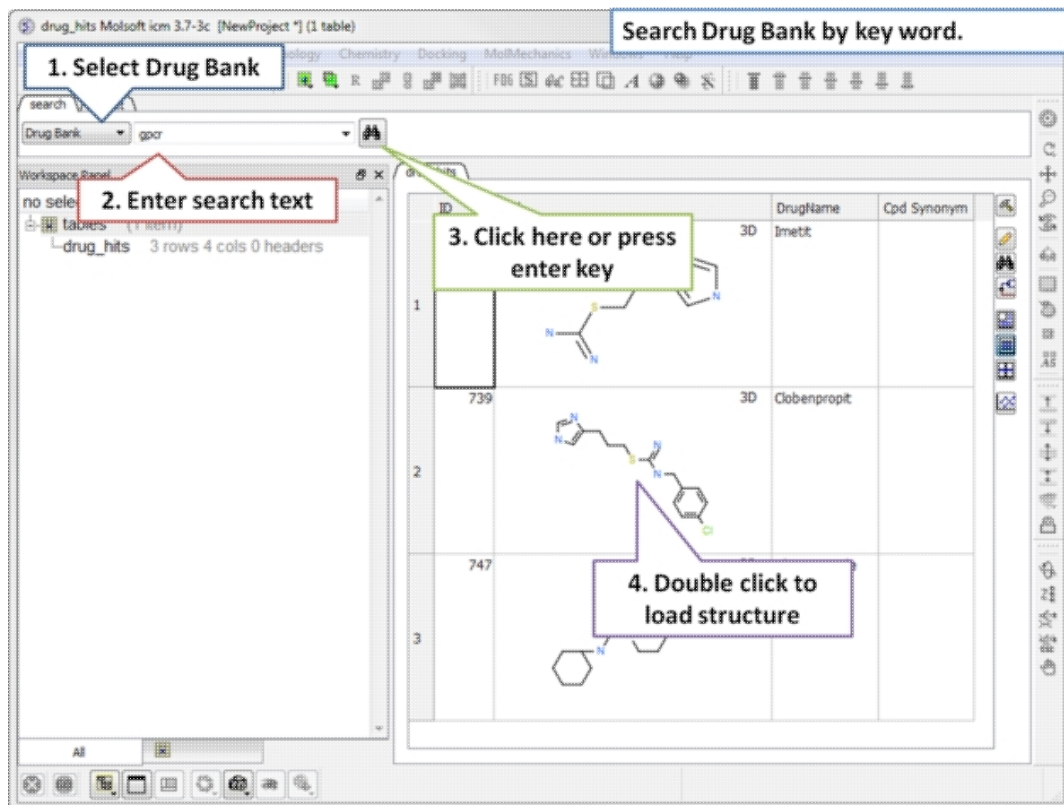

Step 1: Click on the search tab and select **Drug Bank** from the drop down menu. Enter a search string and a table of results will be displayed.

The table contains the original activity data without merging or aggregation. For instance,

Chemical 1, Protein 1, Activity 1
 Chemical 1, Protein 1, Activity 2
 Chemical 1, Protein 2, Activity 1
 Chemical 2, Protein 1, Activity 1

Click on the button **Get Ligand Summary** to display a list of chemicals with all activities found in Drug Bank. The button is located in the extra panel (click on hammer - top right of table panel). For instance,
Chemical 1, Protein 1, Activity 1

Protein 1, Activity 2
 Protein 2, Activity 1
 Protein 3, Activity 1

Chemical 2 Protein 1, Activity 1
 Protein 2, Activity 1
 Protein 2, Activity 2

3.2.9 Search PubChem

To search PubChem (<https://pubchem.ncbi.nlm.nih.gov/>):

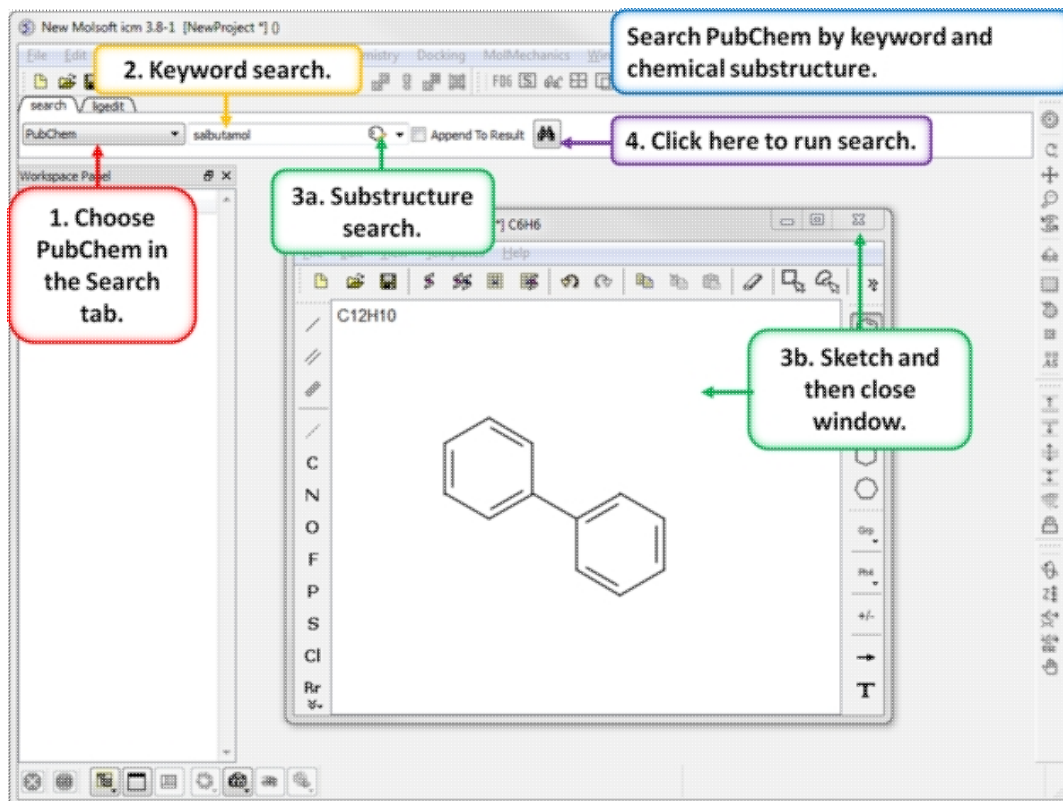

- Click on the search tab and select **PubChem** from the drop down menu.
- Enter a search string and a table of results will be displayed or click on the chemical sketch button and sketch a substructure. When you close the chemical sketch window the smiles string will be added to the keyword search panel.
- Click on the "binocular" button and run the search.
- A table of hits will be displayed.

3.3 Create New Objects

Available in the following product(s): ICM-Browser | ICM-Browser-Pro | ICM-Pro | ICM-Chemist

In the File menu there is an option called New. This option can be used to create new objects of the following types:

- Peptide
- Unusual Peptide
- Compound
- DNA and RNA
- Sequence
- Script
- HTML
- Table
- Arrow
- Box
- Sphere/Ellipsoid

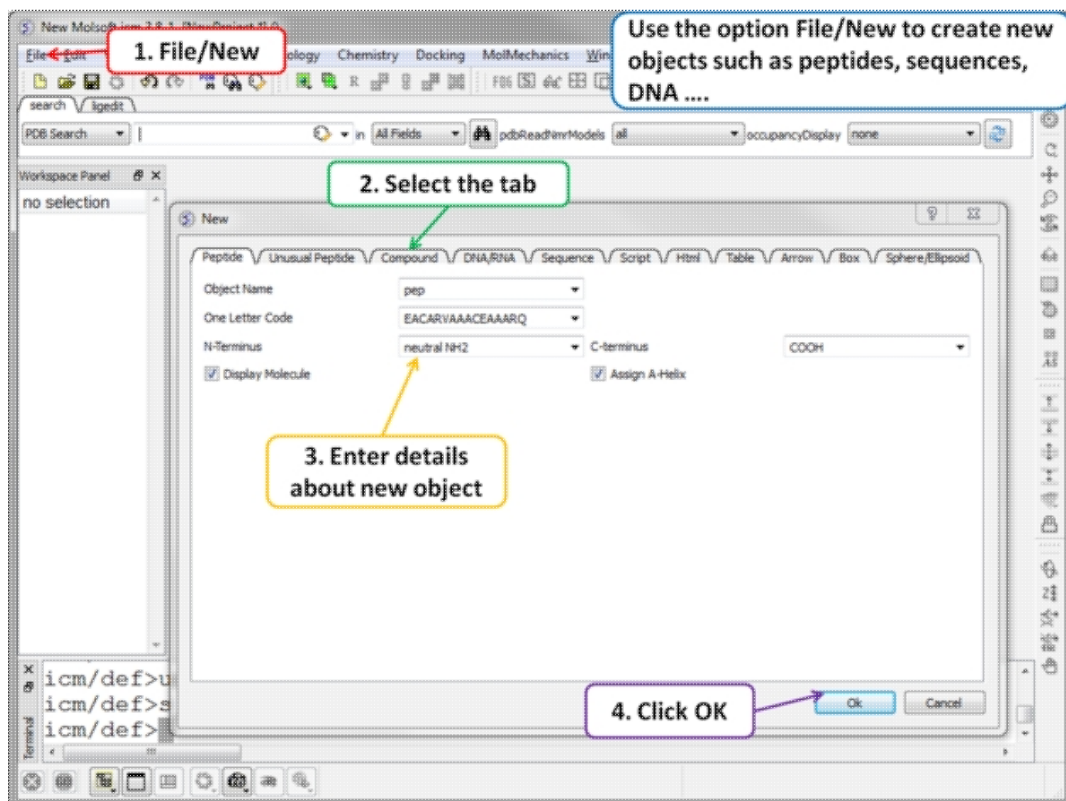

3.4 Open and Read Files

Available in the following product(s): ICM-Browser | ICM-Browser-Pro | ICM-Pro | ICM-Chemist

Any file that ICM can understand can be opened by:

- Selecting File/Open.

A file with an extension `.icb` is an ICM binary file and can be viewed in the GUI. A `.icb` file can contain many objects such as sequences, meshes, protein objects, alignments, tables etc...

3.4.1 Open with Password

To open a file that is password protected:

- File/Open with Password

3.4.2 Extract from icb file

An **icb** file is an `icm project` file, in some instances you may want to take objects saved in an `icb` file and load it in your current ICM session. This option allows you to view a tabulated list of what a `icb` file contains and load individual object files from it.

- File/ Extract from ICB.
- Locate the saved `icb` file.
- A table as shown below will be displayed
- Double-click on any of the entry to extract that object from the `icb` file.

	name	type	size
2	openFilePRJNAME	string	9
3	1TKI_A_4	sequence	491
4	1DI9_A_17	sequence	509
5	1wFC_5	sequence	538
6	1IAN_23	sequence	415
7	1QL6_A_4	sequence	413
8	1ql6_a	sequence	907
9	2phk_a	sequence	786
10	alig	alignment	10927
11	1ql6	object	231820
12	2phk	object	235471

3.5 Saving Files

Available in the following product(s): ICM-Browser | ICM-Browser-Pro
| ICM-Pro | ICM-Chemist

Anything you have displayed in an ICM graphics session can be conveniently stored in a single file called an .icb file. To do this:

- File/Save Project

or

- File/Save Project As

A .icb file can be password protected by:

- File/Save with Password
- Enter a file name or browse for a previously saved project.
- Enter a password
- Determine whether you want the file to be Fully Protected, read only or Read Only and Allow Comments .

Any object (e.g. protein,table, alignment...) inside the ICM GUI can be saved by:

- Right click on the name of the object in the ICM Workspace.
- Select "Save As"
- Choose the file format from the "Save as Type" drop down dialog.

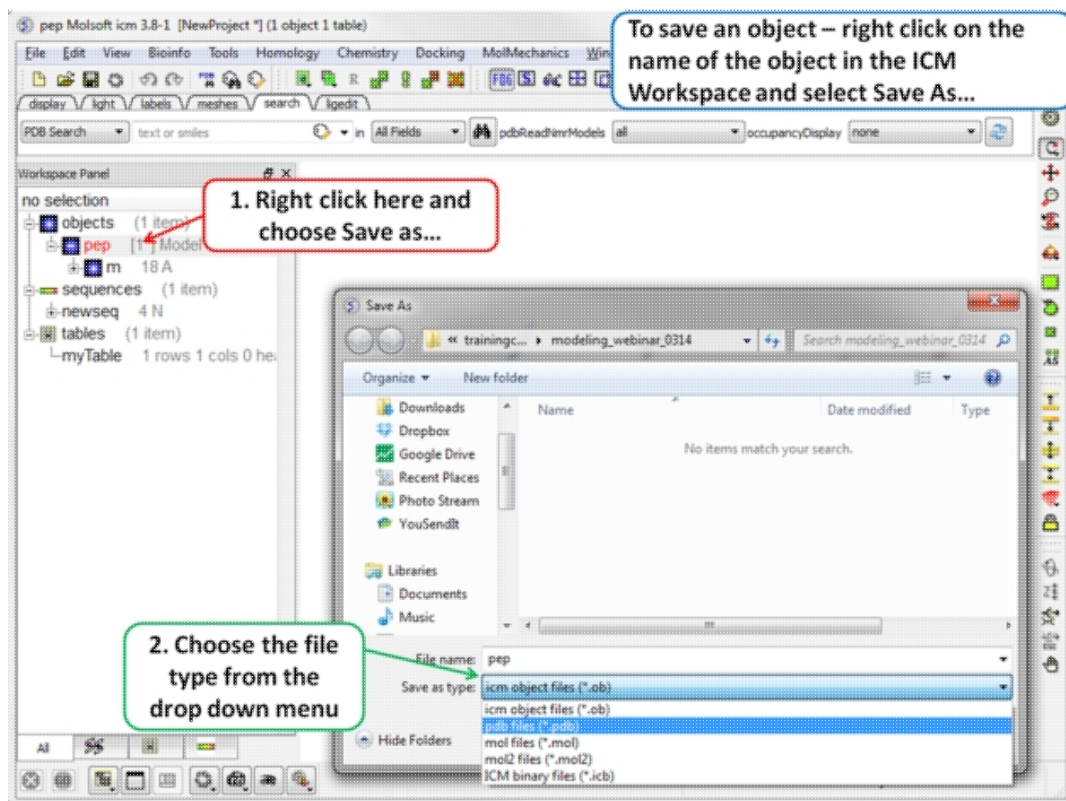

3.6 Making Selections

Available in the following product(s): ICM-Browser | ICM-Browser-Pro | ICM-Pro | ICM-Chemist

Note: Click **Next** (top right hand corner) to navigate through this chapter. Headings are listed on the left hand side (web version) or by clicking the **Contents** button on the left-hand-side of the help window in the graphical user interface.

There will be many occasions when you will have to make selections. For example, if you want to display a particular region or molecule contained within your protein structure or if you want to select residues around a binding pocket. If you have a molecule displayed in the graphics window, then selections will be displayed as green crosses. The selection you have made is also displayed at the top of the ICM Workspace. It is always a good idea to keep an eye on what is selected and what isn't.

There are four basic levels of selection

1. Object (eg a PDB structure or ICM object)
2. Molecule
3. Residue
4. Atom

You can make selections in:

- The Graphics Display
- The ICM Workspace (Selections are highlighted in blue)
- Tables
- Sequences
- Plots

- Alignments

3.6.1 Graphical Selection Tools

The following buttons can be used to make a selection once a structure is displayed.

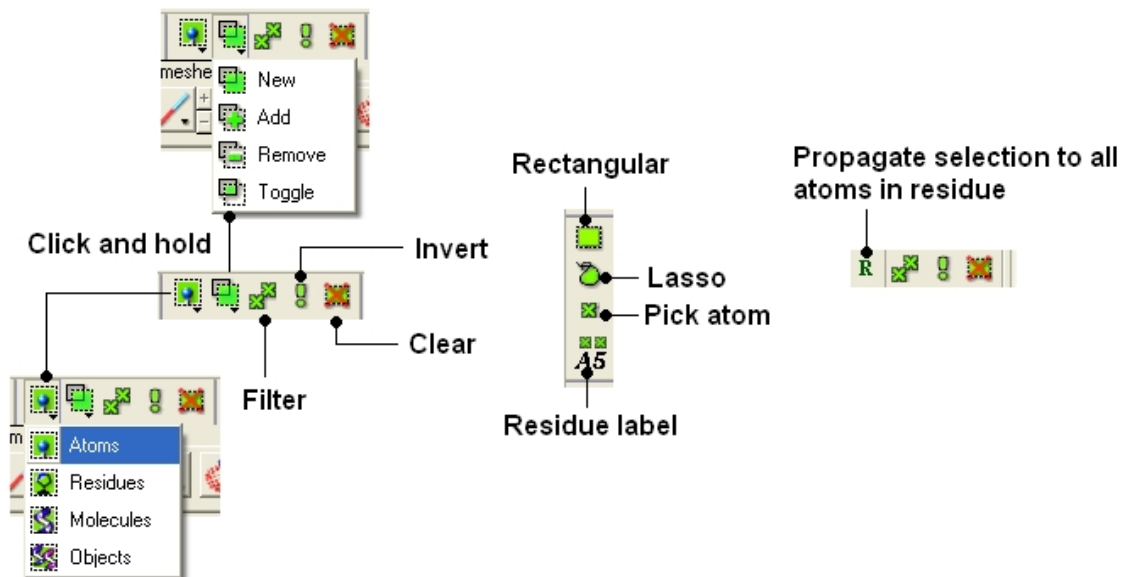

NOTE: All selection tool buttons are colored green. Graphical selections are represented as green crosses.

3.6.2 Quick Selection

To make a quick selection the following buttons can be used.

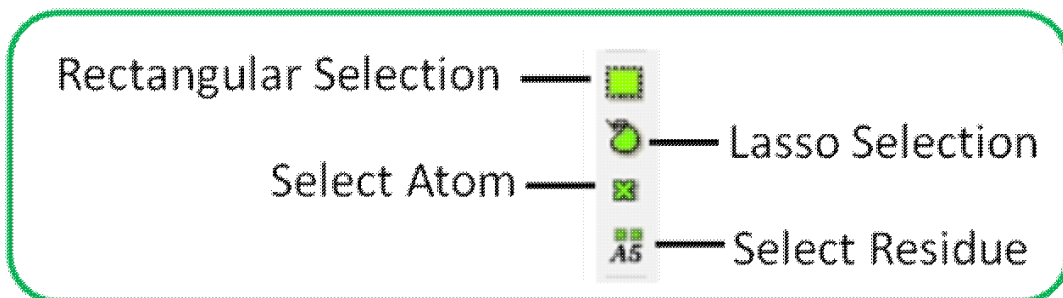

To select parts of your structure:

- Click on the **Rectangular selection icon** and click and drag around the part of the structure you wish to select.

OR

- Click on the **Lasso selection icon** and click and drag your mouse around the area of the structure you wish to select, forming a lasso around it.

To pick individual atoms:

- Click on the 'pick atom' button

3.6.3 How to Change the Selection Level and Mode

It is possible to change the level of selection before or during the building of a selection. The selection level drop-down button can be used to do this (see image below).

For example, a C-alpha of a residue is selected but one would like to select all atoms in the residue. You can change the level to **Residues**. This selection can then be changed into all atoms of the residue by then selecting the **Atoms** level again. Or you can use the **Propagate Selection to all Atoms** button (see image below).

- Click on the **Select objects**, **Select molecules**, **Select residues**, or **Select atoms** icon, depending on which part of the structure you wish to be highlighted.

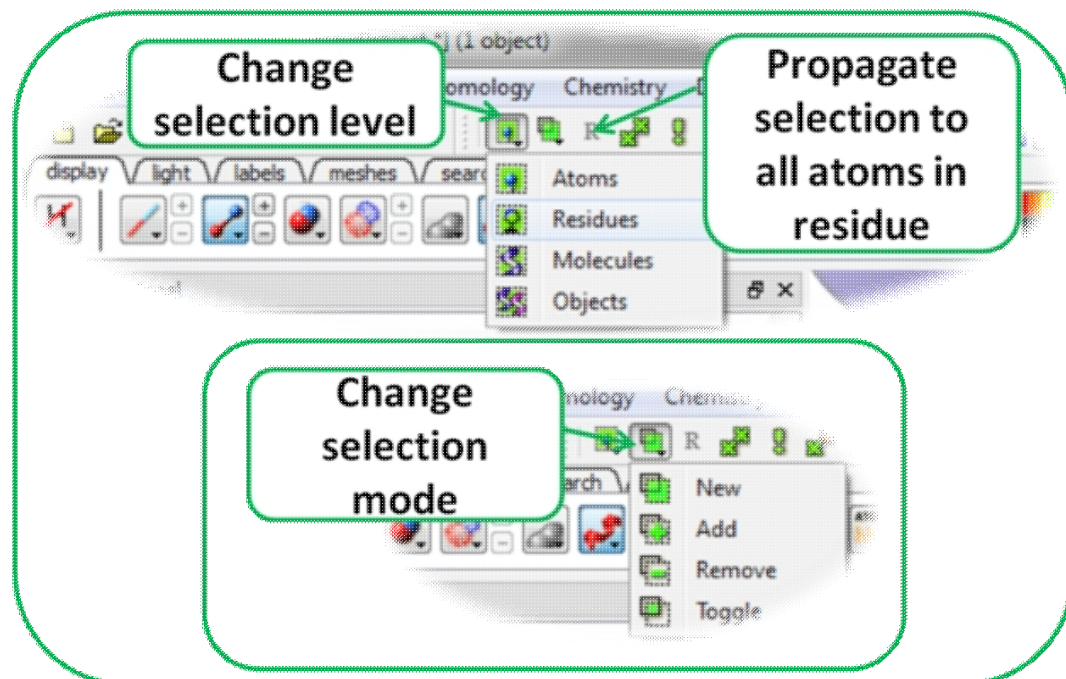

It is also important to observe the selection mode that is being used. There are four modes:

- **New:** new selection replaces everything selected before
- **Add:** new selection is added to previous selection(s), if any
- **Remove:** previously selection (part or whole of it), if included in the new selection will be unselected.
- **Toggle:** within the new selection, everything that has been selected is unselected and everything that hasn't been selected, will be selected

3.6.4 How to check what is selected.

All selections are displayed as green crosses in the graphical display and blue in the ICM Workspace. All green selections are returned to a variable called as `_graph`.

Selections are displayed as green crosses in the graphical display and highlighted in blue in the ICM Workspace.

Here the selection information is reported

Selection are highlighted in blue in the ICM workspace

Selection shown as green cross in graphics window

```

icm/lxbb>display xstick as_graph
icm/lxbb>as_graph = Atom( Res(Sphere( a_lxbb.astl/1 (Mol( {a_*/D
icm/lxbb>undisplay store a_l
icm/lxbb>display wire a_lxb
icm/lxbb>undisplay store a_l
icm/lxbb>display xstick a_l
icm/lxbb>as_graph
  
```

All green graphical selections are returned to a variable called as_graph

3.6.5 Orange Selection

Sometimes it is necessary to have two different selections. The Orange selection allows you to do this it is useful for such operations as superposition and more technical procedures such as designing a protein loop. The orange selection is returned to a variable called as2_graph.

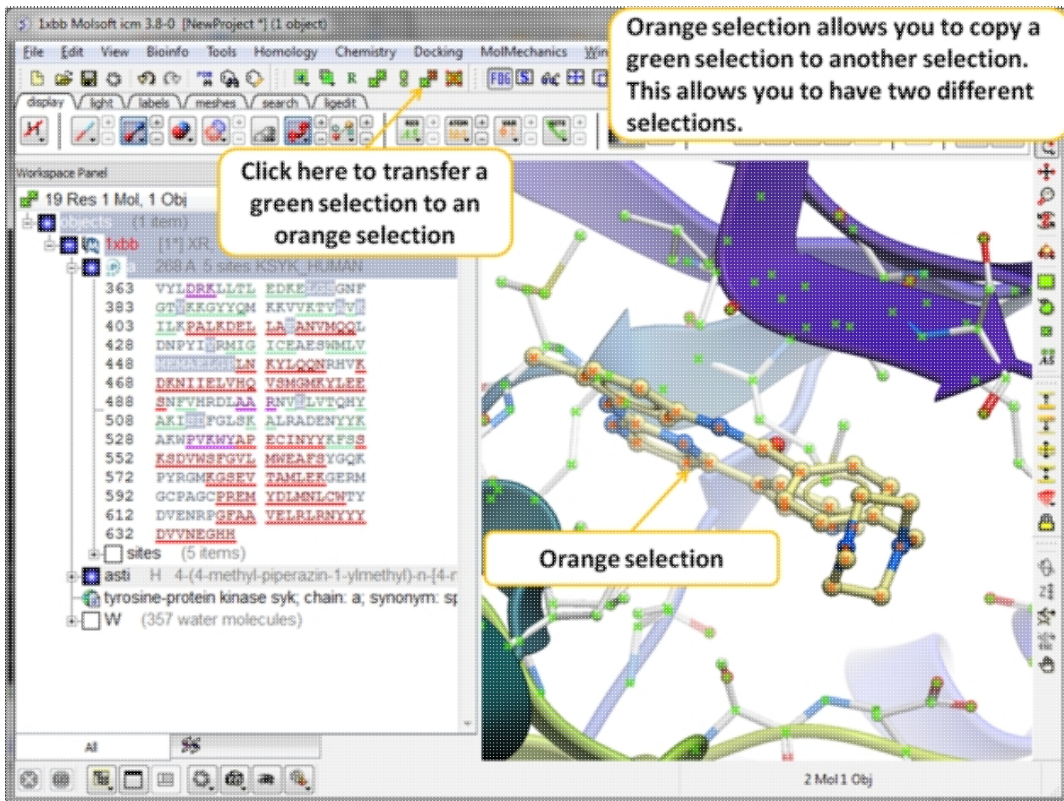

3.6.6 Clear Selection

To unselect everything you have previously selected:

- Simply click on the **Clear Selection** button on the selection toolbar.

OR

- Right click and drag away from the displayed structure.

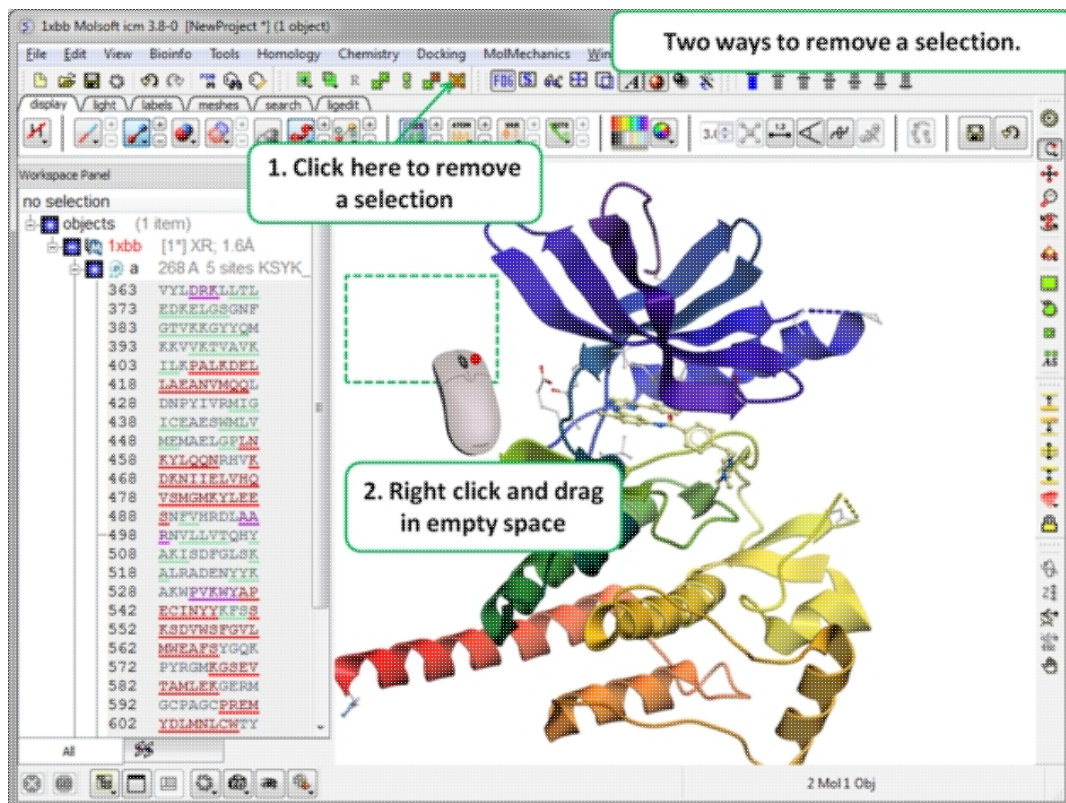

3.6.7 Changing a Selection

Once you have made a selection you may wish to add or remove parts of the selection. The buttons shown below allow you to accomplish this.

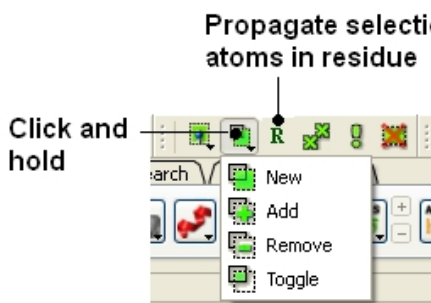

To add or remove from your current selection:

- Click on the **Selection mode: add** or **Selection mode: remove** icon on the toolbar.
- Click and drag around the part of your structure you wish to add or remove.

You may also wish to invert your selection in a specific part of the structure.

The parts that are currently selected will become unselected, and the unselected parts will become selected.

In order to invert a selection:

- Click on the **Invert** icon on the toolbar.

If you wish to select and unselect certain regions of a selection the toggle selection button is very useful.

- Click on the Toggle selection button.
- Right click around the selections you wish to select or unselect.

NOTE: The selection you have made is recorded at the top of the ICM workplace. Any selection is stored in the variable as_graph.

3.6.8 Filter Selection

You may want to be very specific about a selection you want to make. For example you may only want to select protein backbone atoms or you might want to just select the charged residues.

The button shown below enables you to filter your selection:



Or

Right click on a selection and a menu as shown below will be displayed.

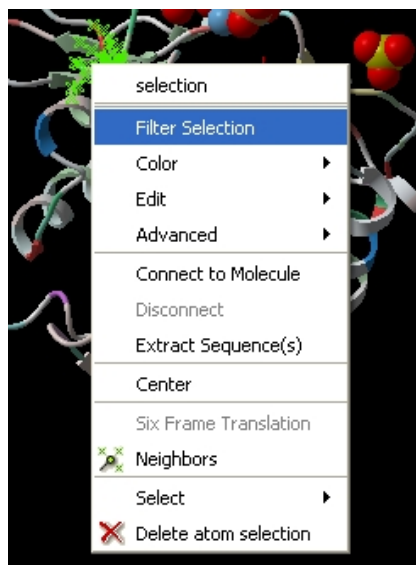

- Select the Filter Selection option.
- A dialog box will be displayed as shown below.
- Select what level of selection you want e.g. atom or residue.

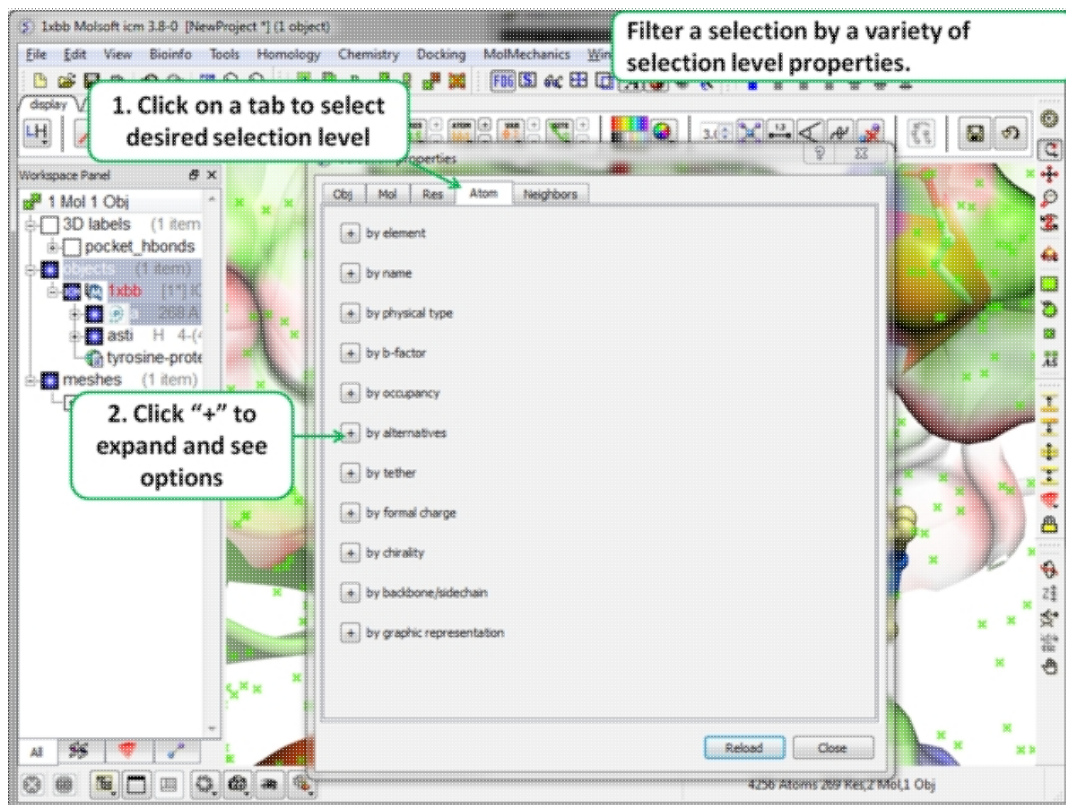

3.6.9 Workspace Selections

In the default GUI layout the workspace panel is located to the left of the 3D graphics display. It is a great tool for keeping track of all your sequences, pdb structures, objects, tables and alignments. As you will see in this section it also provides a way of making selections.

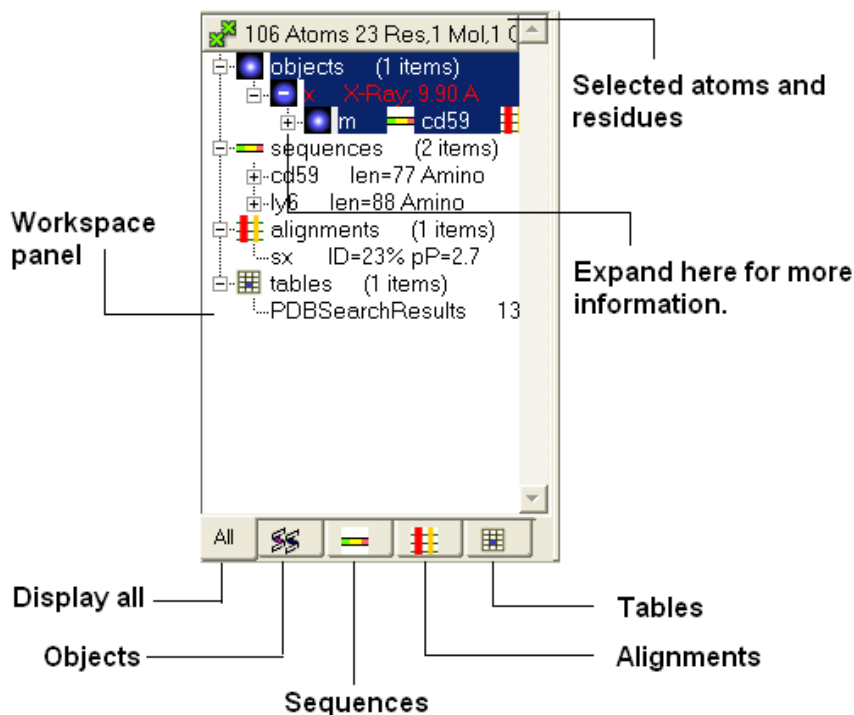

3.6.10 Workspace Navigation

Once you have mastered how to navigate the ICM workspace making a selection will become easier. Each object is divided into 3 levels:

1. Object Level - Shown in red if it is the current object. Holds details about the structure - name, X-ray, NMR, resolution etc. Importantly it will state whether the structure is an ICM object or a structure straight from the PDB. To learn how to convert a PDB into an ICM object go to the section on [converting a PDB](#).
2. Molecular Level - Shows the individual subunits, ligands and hetatoms of a molecule.
3. Residue Level - Shows the sequence.

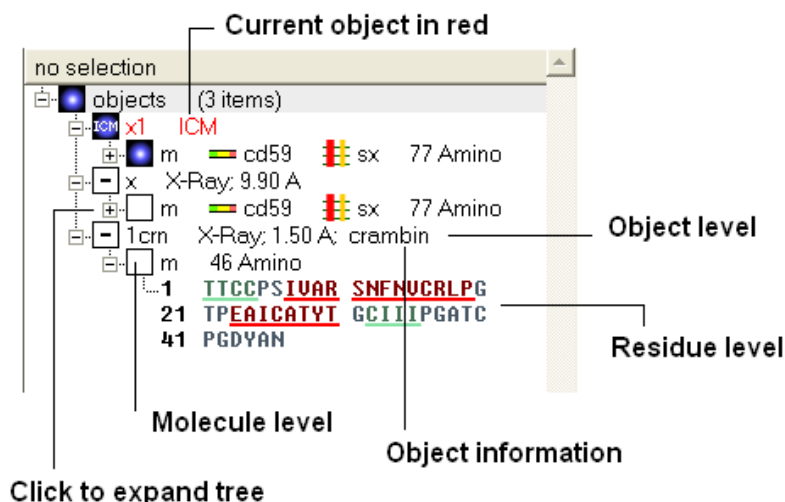

NOTE: You can expand each level of the ICM workspace by clicking the "+" button as shown above.

3.6.11 How to Select an Object

To select the whole object:

- Double click on the object level.

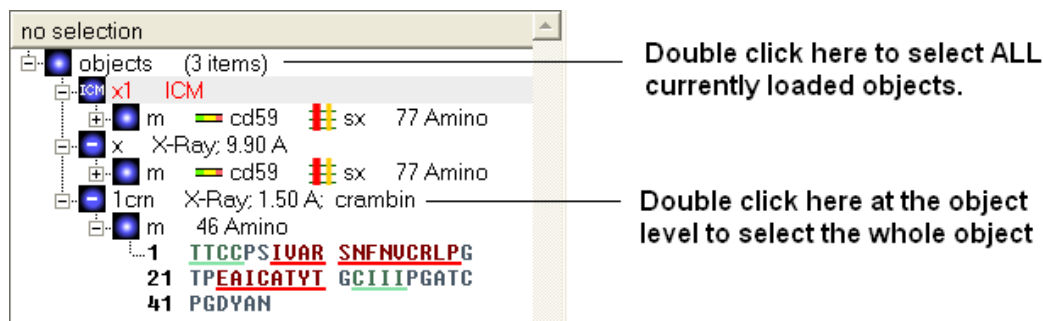

Use the CTRL button to select multiple non-contiguous objects or if they are continuous you can use double click and hold the tab button.

3.6.12 How to select a Molecule

To select a molecule(s):

- Double click on the molecule in the ICM workspace.

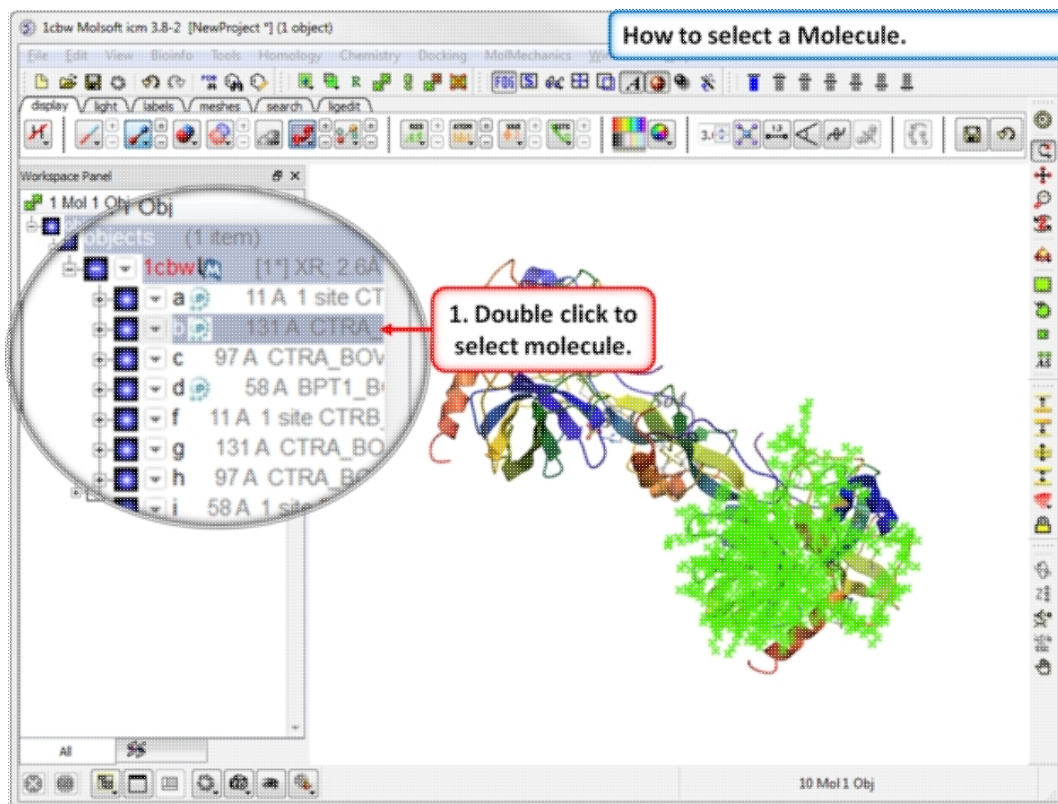

Use the CTRL button to select multiple non-contiguous molecules or if they are continuous you can use double click and hold the tab button.

3.6.13 How to select Residues

There are different options to select residues:

OPTION 1:

- Click and drag over the residues you wish to select in the ICM workspace. Selected residues will be highlighted in dark blue in the workspace and with green crosses in the graphical display.

Selection information is recorded here

Click here to expand tree to show amino acid residues.

Click and drag over residues you wish to select.

Selected residues will be highlighted in the workspace and graphics window

184 Atoms 35 Res.1 Mol.1 Obj

objects (1 items)

1BB X-Ray: 2.80 Å: rhodopsin

a 338 Amino OPSPD_BOVIN

1	MNGTEGPNFY	DPFSNKTGVU
21	RSPFEAPQVY	LAEPVQFSML
41	AAVMFLLIML	GFPINFLTLY
61	UTUQHKKLRT	PLNYILLNLA
81	UADLFHVFEG	FTTTLTSLH
101	GVFVFGPTGC	NLEGGFATLG
121	GEIALWLSLV	LAIERYVUUC
141	KPMSNFRFGE	NHAIMGUAFI
161	WUMALACAAP	PLUGWSRYIP
181	EGHQSCGID	YYTPHEETNN
201	ESFUIYMFUV	HFIIPLIUIF
221	FCYGQLUFTV	KEAASATTQ
241	KAEKEUTRMV	IIMVIAFLIC
261	WLPYAGUAFY	IFTHQGSDFG
281	PIFMTIPAFF	AKTSAUVNPU
301	IYIMMNKQFR	NCHUTTLCCG
321	KNPSTTUSKT	ETSQVAPA

Any selection is highlighted in the workspace as well as in the 3D graphics window if the structure is displayed.

OPTION 2:

- Click on the **rectangular selection** icon or **lasso selection** icon on the toolbar.
- Click and drag around the residues you wish to select. Selected residues will be displayed by green crosses on the graphical display and blue in the ICM workspace.
- Use the propagate selection to residue level button.

OPTION 3:

- Right click on the a residue in the graphical display and a menu as shown here will be displayed.

selection
Selection Dialog
Advanced ▶
Residue atoms ▶
Open with MolEdit
Connect to Molecule
Disconnect
Extract Sequence(s)
Center
Annotate selection
Neighbors
Closed Cavities
Select ▶
Delete residue selection

- Click on **Select** and a further menu will be displayed.
- Click on **Residue, Molecule** or **Object**.

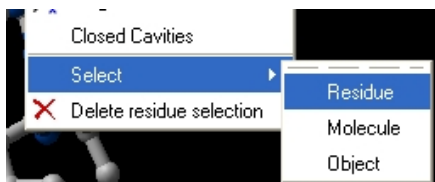

OPTION 4:

Use the select residue button.

3.6.14 Select All

Ctrl + A will select everything in the ICM workspace, and Ctrl + Shift + A will unselect your objects.

NOTE: The selection you have made is always recorded at the top of the ICM workplace. If you are familiar with using the ICM terminal (See language manual) the atoms, residues, molecules or objects selected interactively in the graphics window are automatically s

3.6.15 Selecting Neighbors

In some instances you may only want to display or select only a subset of a structure. For example you may only wish to display the residues surrounding a ligand (as shown below (ligand red; graphical selection green crosses). The "Selecting Neighbors" option selects the residues within a sphere of a defined radius.

There are two ways of selecting neighbours to a particular atom or residue in ICM. Either by right clicking on the atom or residue in the graphical display or by right clicking in the ICM workspace.

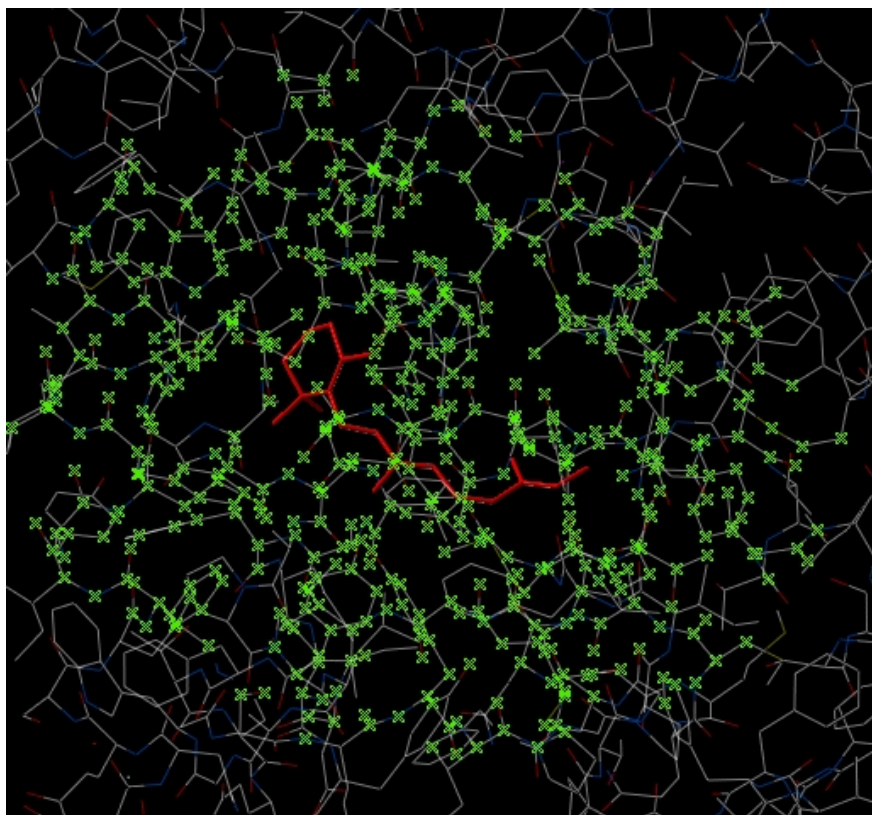

3.6.16 Selecting Neighbors: Graphical

To select neighboring atoms or residues around a sphere of a certain radius:

- First select the residue(s) or atom(s) around which you wish to select neighbors. (See the Selection Toolbar Section)
- Right click on the selection and a menu as shown below will be displayed or choose Tools/Geometry/Neighbors.

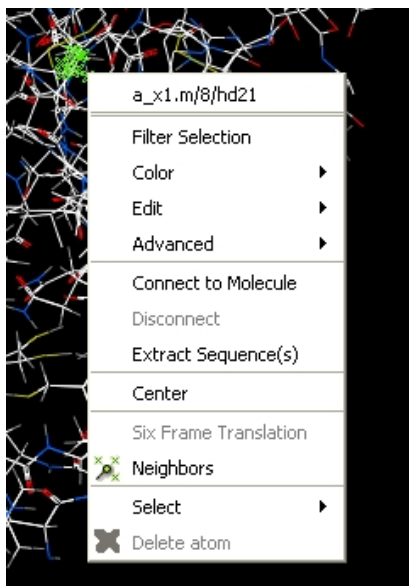

- Select the Neighbors option and a data entry box as shown below will be displayed.

This option will allow you to make a spherical selection.

The window will open as displayed as below:

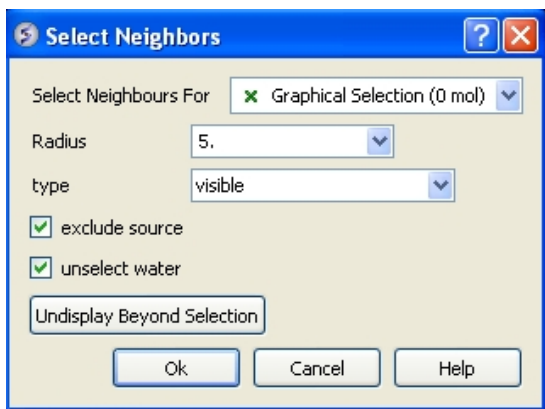

- Select the molecule you wish to select neighbors around. For example you can select a ligand in the ICM workspace and then choose the **Graphical Selection** option in the "Select Neighbors For" dialog entry box. Or alternatively you can select the object by clicking on the drop down button next to the "Select Neighbors For" dialog entry box.
- Enter the radius in Angstroms for the neighbor selection, e.g. 5.
- **Type** - this option is **important**. This option relates to what is going to be selected. For example if you leave this option as **visible** and you only have ribbon representation displayed for your

receptor (e.g. when selecting neighbors for a ligand) then only backbone atoms will be selected.

Selection **Type** option includes:

- **visible** - will select all atoms displayed within the radius selected.
- **visible sidechains** will select all visible side-chains - not backbone atoms.
- **same_object_other_chains** will select all atoms in other chains in the same object as the original selection.
- **other objects** will select atoms in objects other than the original selection.
- **same object** will select atoms in the same object as the original selection.
- **all_objects** will select atoms in all objects
- **choose_from_list** will allow you to select the object you wish to include in the neighbors selection.

- **exclude source** if checked will not include your original selection in the spherical selection.
- **unselect water** if checked will not select water molecules
- **Undisplay Beyond Selection** will only display the atoms selected.

NOTE: The selection you have made is always recorded at the top of the ICM workplace. If you are familiar with using the ICM terminal (See language manual) the atoms, residues, molecules or objects selected interactively in the graphics window are automatically saved in the variable `as_graph`. Graphical selections are shown in green (crosses) or highlighted in blue in the ICM Workspace.

3.6.17 Selecting Neighbors: Workspace

To select neighboring atoms or residues around a sphere of a certain radius from a residue in the ICM workspace:

- First select the residue in the ICM workspace around which you wish to select neighbors. (See the [Residue Selection](#))
- Right click on the selection and a menu as shown below will be displayed.

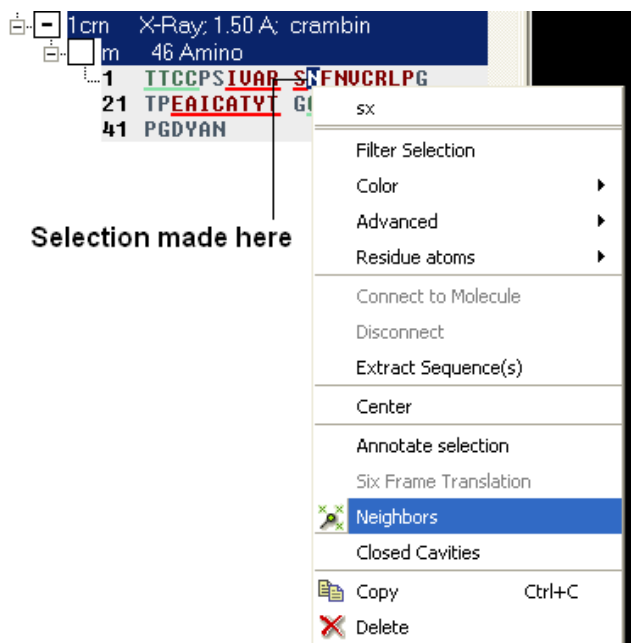

- Select the Neighbors option and a data entry box as shown below will be displayed.
- Follow the instructions in the previous section.

NOTE: The selection you have made is always recorded at the top of the ICM workplace. If you are familiar with using the ICM terminal (See language manual) the atoms, residues, molecules or objects selected interactively in the graphics window are automatically s

3.6.18 Select by Residue Number

To select by residue number:

- Right click on the molecule you wish to make the selection in and choose Select/Res Number...
- Enter the residue numbers e.g. 3,7:12,30 Colon indicates range.

3.6.19 Alignment and Table Selections

Descriptions on how to make selections in Alignments and Tables are in the sections entitled Making Selections in Alignments and Making Table Selections.

3.6.20 Making Links

It is sometimes necessary to make links between sequences objects and alignments. A link enables you to make selections in one environment such as an alignment and then these selections are transferred to the object such as the PDB structure displayed.

If a link is made then a symbol will be displayed next to the object in the ICM workspace. In the example shown below subunit_a of the X-ray structure 1ql6 is linked to the sequence 1ql6_a and the alignment called 'alig'.

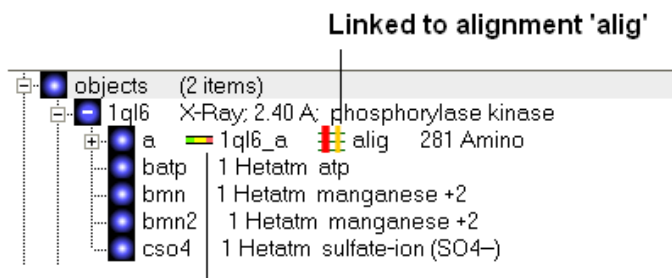

Linked to sequence 1ql6_a

If an object is linked to an alignment a symbol as shown below will be displayed.

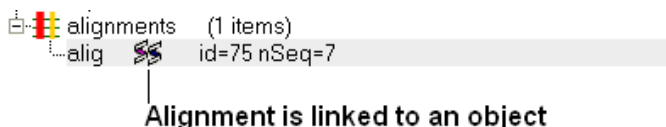

To link a sequence from an object - extract the sequence from the object.

- Right click on the object in the ICM workspace.
- Select extract sequence.

To link a sequence and object to an alignment.

Use the extracted sequence as described above to build your alignment.

In addition a link can be made between a structure and alignment by:

- Bioinfo/Link to Structure.
- Enter alignment name.
- OK

3.6.21 Tags

It is sometimes convenient to tag selections so you can come back and use them at a later date. To do this:

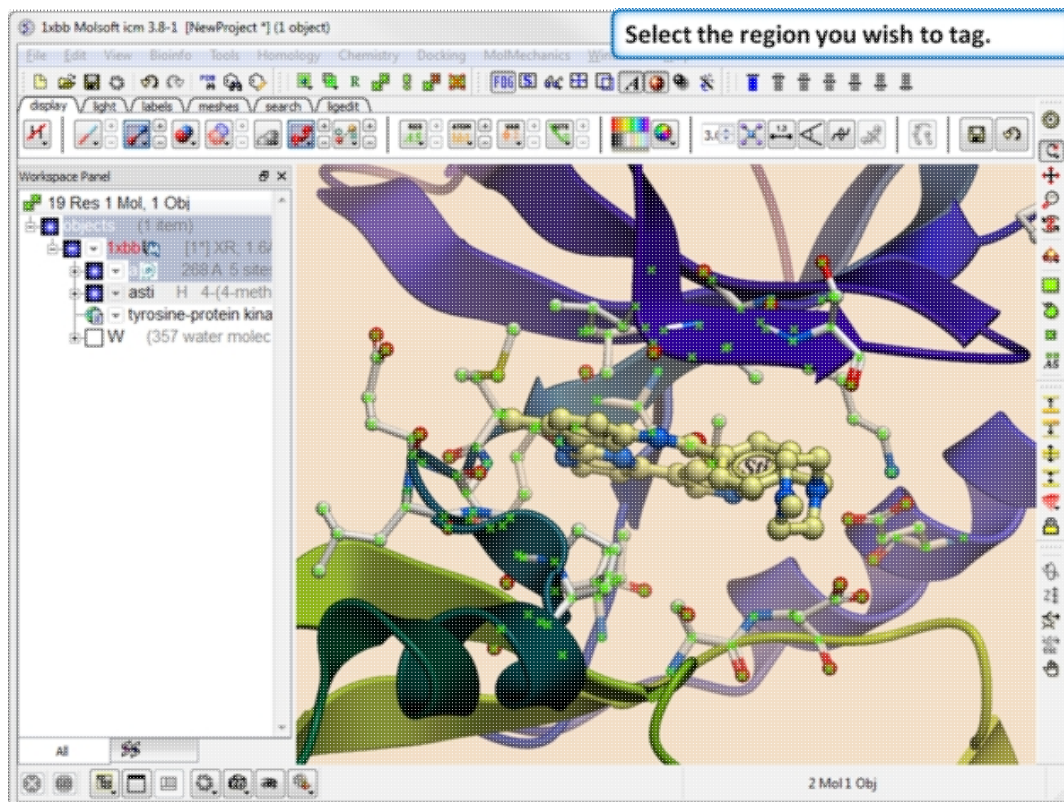

Step 1. Select the region you wish to tag.

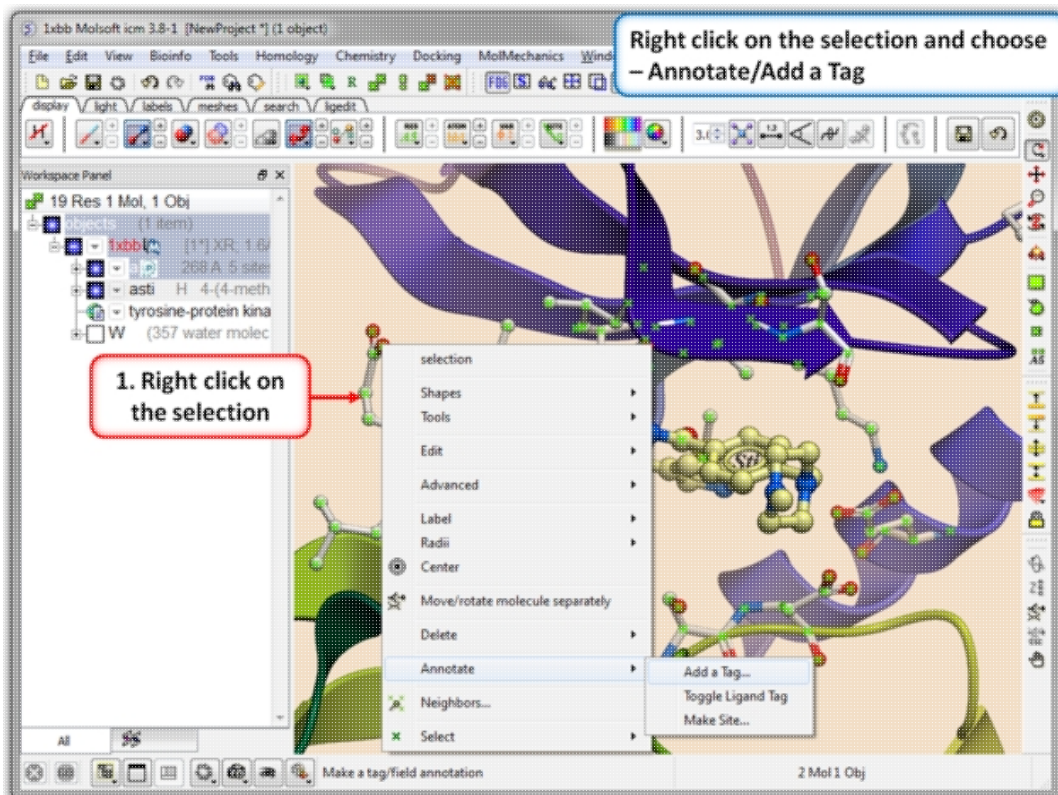

Step 2. Right click on the selection and choose Annotation/Add a Tag.

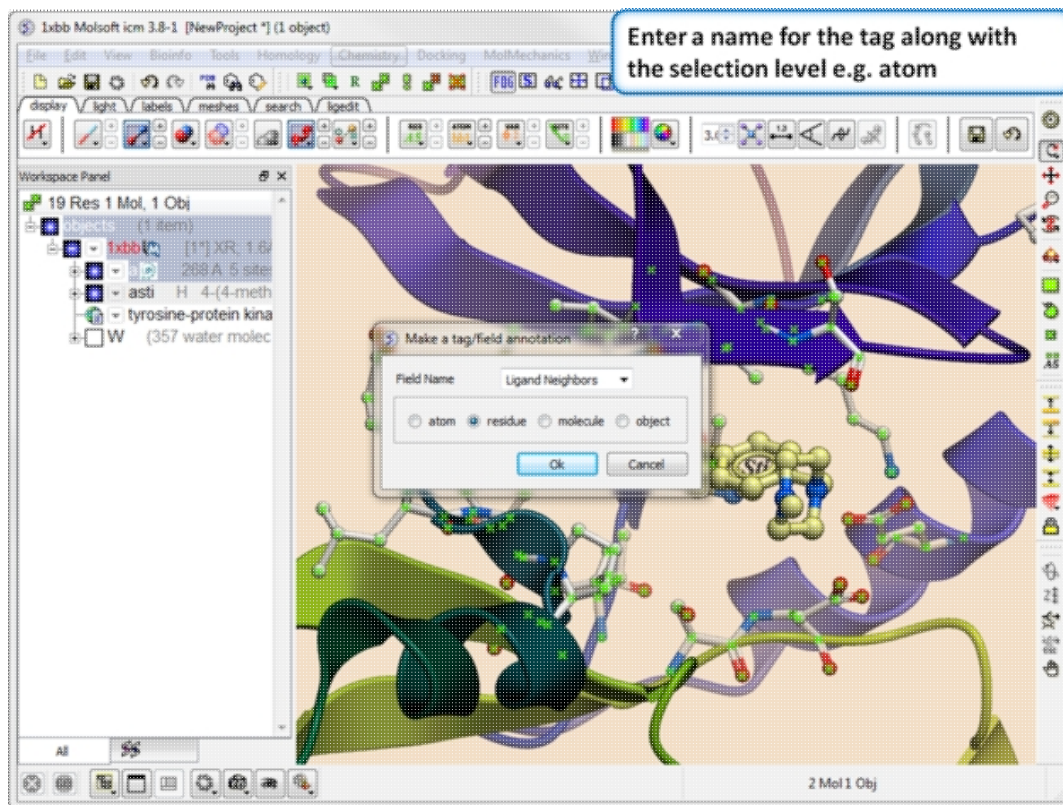

Step 3. Give the tag a name and choose the selection level (atom, residue, molecule, or object).

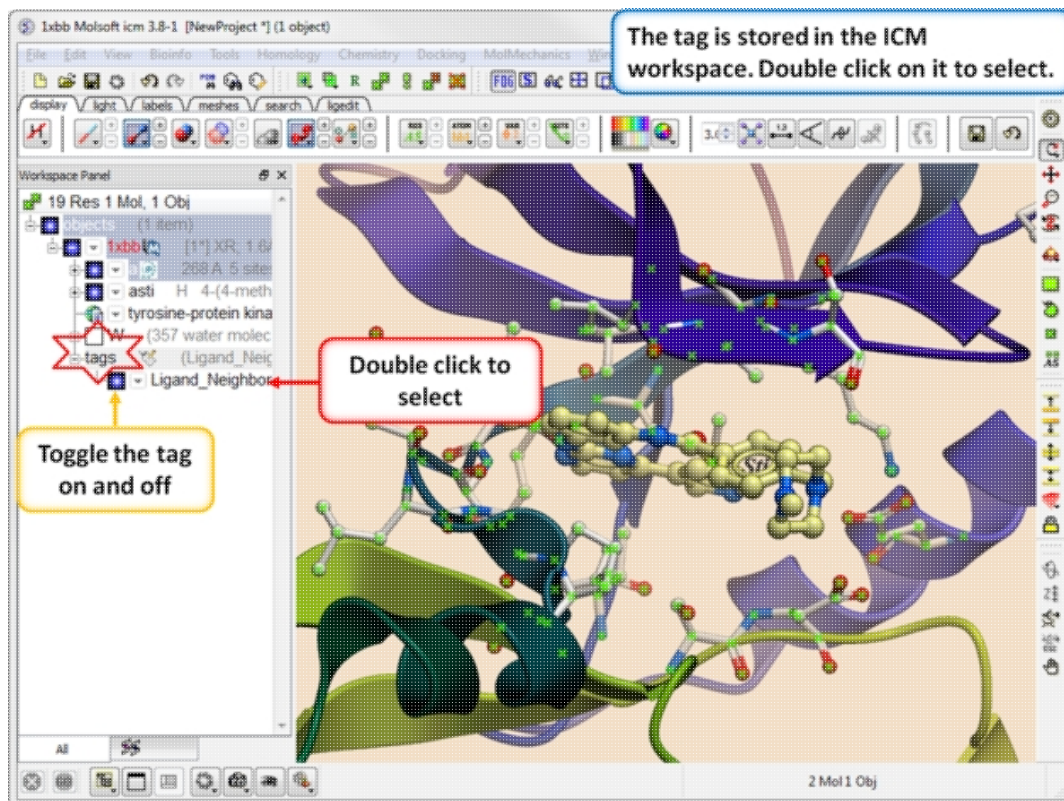

Step 4. You will see the tag in the ICM Workspace. You can toggle the display on or off or select the tag by double clicking on it in the ICM Workspace.

3.7 Preferences

Your ICM preferences can be changed by:

- Select File/Preferences.

NOTE: There is a "Reset to Default" button in case you make any changes you are not happy with and also a search option.

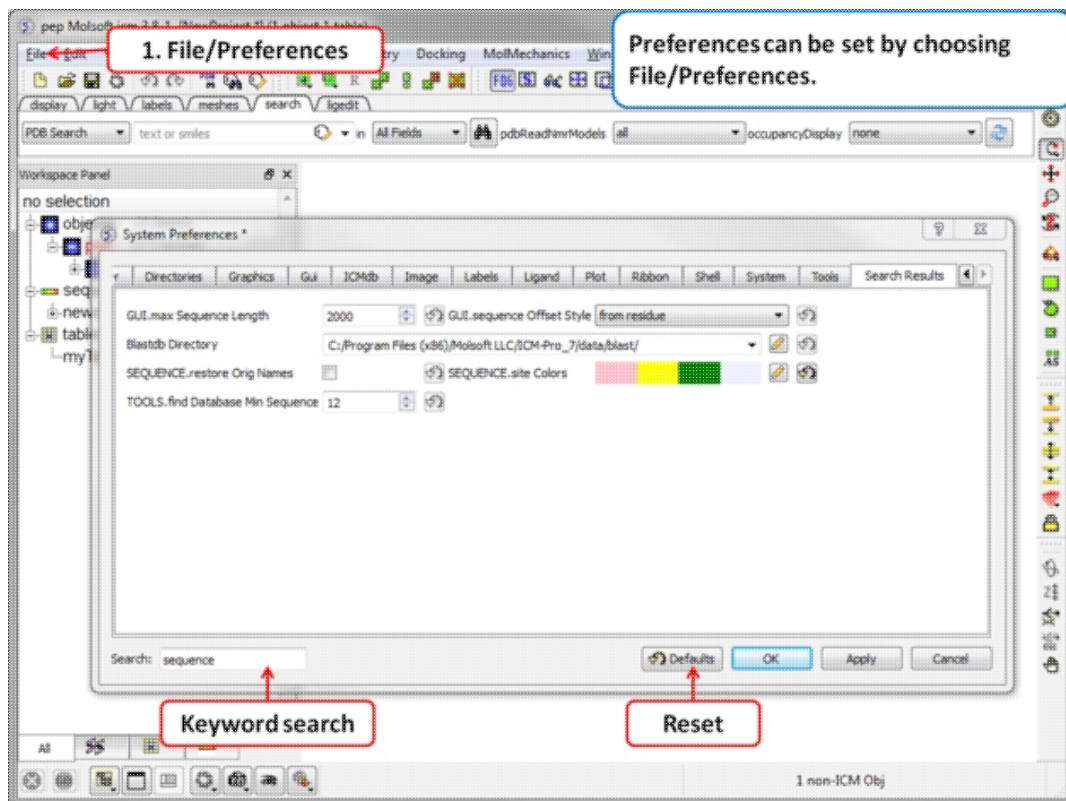

3.7.1 Bonds Preferences

To change Bond Preferences:

- Select File/Preferences.
- Choose the **Bonds** tab.

GRAPHICS.ballStickRatio - A default ratio of ball and stick radii. This ratio is applied when the styles are switched from the GUI xstick toolbar. Default (1.4)

GRAPHICS.hbond Ball Period - Default (3)

GRAPHICS.hbondMinStrength - parameter determines the hbond strength threshold for hbond display. The strength value is between 0. and 2. By changing 1. to 0.2 you will see more weak hydrogen bonds. Default: (1).

GRAPHICS.hbondStyle - determines the style in which hydrogen bonds are displayed. Here hbond-Donor, Hydrogen, and hbond-Acceptor atoms will be referred to as D, H and A, respectively,

GRAPHICS.hetatmZoom - The default ball and stick radii of a ligand can be different by the GRAPHICS.hetatmZoom factor. This makes a better ligand view since the ligand stands out from the surrounding protein atoms.

GRAPHICS.stickRadius - radius (in Angstroms) of a cylinder displayed as a part of stick or xstick graphical representation of a molecule. Individual (residue-wide) control of stick radii.

GRAPHICS.xstick Backbone Ratio - Default (1.2)

GRAPHICS.xstick Style - xstick style

wireBondSeparation the distance between two parallel lines representing a chemical double bond if wireStyle = "chemistry". Default (0.2 Angstroms).

GRAPHICS.distance Label Drag - enable distance label dragging

GRAPHICS.hbondAngleSharpness determines how the strength depends on the D-H...A(lone pair) angle. The preference can be found the general Preferences menu Default (1.7)

GRAPHICS.hbond Ball Style even, by atom size, by energy or telescopic

GRAPHICS.hbond Rebuild

GRAPHICS.hbondWidth relative width of a displayed hbond .

GRAPHICS.hydrogenDisplay determines the default hydrogen display mode for the display command.

```
GRAPHICS.hydrogenDisplay = "polar"
  1 = "all"      # all hydrogens are shown
  2 = "polar"   <-- current choice # polar displayed, the non-polar hidden
  3 = "none"   # no hydrogens are displayed
```

GRAPHICS.wire Width - relative width of wire Default (1)

GRAPHICS.xstick Hydrogen Ratio - Default (0.5)

GRAPHICS.xstick Vw Ratio - Default (0.6)

Wire Style - change the default wire style

```
GRAPHICS.hbondStyle = "dash"
  1 = "wire"      # Just a line
  2 = "chemistry" # shows different types of chemical bonds.
  3 = "tree"     # shows a directed graph of the ICM-molecular tree
  4 = "aromatic" #
```

3.7.2 Directories Preferences

DIRECTORIES TAB:

To change Directory Preferences:

- Select File/Preferences.
- Choose the **Directories** tab.

Within this tab you can select the default directories for:

FILTER.gz, FILTER.uue, FILTER.Z, Filter.zip allows you to read compressed files .gz, .uue, .Z, and, .zip files automatically leaving the compressed file intact.

PDB Directory Style - The style of your Protein Data Bank directory/directories. ICM will understand all of the listed styles, including distributions with compressed *.gz , *.bz2 and *.Z files

BlastDB Directory - return directory with Blast-formatted sequence files for ICM sequence searches. You can download Blast formatted databases from here <ftp://ftp.ncbi.nih.gov/blast/db/>

Dock Directory - Default directory for storing docking files.

CCP4 Directory

Editor - Select a default text editor

Inx Directory - location of stored index (*.inx) files.

Log Directory - when you quit an icm-session, a _seslog.icm file is automatically stored. If the s_logDir variable is empty, it is stored to the s_userDir + "/log/" directory. However one can redirect it to the current working directory (".") or any other directory.

Output Directory -

PDB Directory - directory containing the PDB database of 3D structures. These files can also be easily downloaded directly from the PDB site if the variables are set as in the example below. PDB distributions can exist in several styles (all files in the same directory, or divided etc.).

PDB Directory FTP

PDB Directory Web

Projects Directory - Select the default location for storing ICM projects. Save your data in an ICM project. It is a convenient way of keeping all your structures, alignments, tables, docking results etc... in one place. A description on how to save an ICM project is described in the GUI Basics section of this manual.

Prosite Dat - location of the prosite.dat file a dictionary of protein sites and patterns, (Copyright by Amos Bairoch, Medical Biochemistry Department, University of Geneva, Switzerland).

Ps Viewer - Select a postscript viewer

Swissprot Dat - location of swissprot.dat file

Temp Directory - scratch directory for temporary files (some montecarlo files will be saved there).

Uniprot Dat - location of uniprot.dat file

XPDB Directory - Path to the ICM XPDB database of compact binary ICM objects which are annotated with the site information. The advantage of the XPDB database is the speed of reading and smaller size than PDB. XPDB entries are read about 80 times faster!

TOOLS.default ChemDB

TOOLS.eds Directory

TOOLS.pdb Read Nmr Models

1. = "first" : reads only one model from a multi-model (e.g. NMR) pdb file
2. = "all" : reads all models from a multi-model (e.g. NMR) pdb file and creates a separate
3. = "all stack" : creates one object and loads all other models as a stored cartesian stack

3.7.3 Graphics Preferences

To change Graphics Preferences:

- Select File/Preferences.
- Choose the **Graphics** tab.

Atom Single Style - display style of isolated atoms in the wire mode.

1. "tetrahedron"
2. "cross"
3. "dot"

GRAPHICS.clash Style - choose clash length, strain or length.

GRAPHICS.clip Grobs - enable grob clipping.

GRAPHICS.clip Static -

GRAPHICS.grobLineWidth - relative width of displayed lines of 3D meshes (grobs). Also affects the interatomic distance display.

GRAPHICS.lightPosition - X ,Y and Z position of the light source in the graphics window. The X and Y coordinates are usually slightly@@ beyond the [-1. 1] range where [-1.,1.] is the size of the window, and the Z position is perpendicular to the screen and is set to 2. (do not make it negative).

GRAPHICS.occupancyDisplay preference controlling if and how the partial or zero atom occupancies are displayed. The abnormal occupancies are shown as circles around atoms. These following values are allowed.

```
1. = "none" # nothing is displayed
2. = "circle" # a circle is displayed
3. = "label" # a circle and a label with the value (zero values are not shown)
```

GRAPHICS.quality - integer parameter controlling quality (density of graphical elements) of such representations as cpk, ball, stick, ribbon . Do not make it larger than about 20 or smaller than 1.

GRAPHICS.ruler Style - change ruler from center to side

GRAPHICS.stereoMode - 1. "up-and-down", 2. "line interleaved" 3. "in-a-window"

- a simple hardware stereo mode for workstations with a horizontal frame splitter.
- In the "up-and-down" mode a longer frame with two stereo images on top of each other is generated and the two halves are then superimposed with the splitter. This mode does not require anything from a graphics card, but does require a frame splitter. A frame splitter box was connected between a monitor and a graphics card output. This mode has an unpleasant side effect, the rest of the screen (beyond the OpenGL window) becomes stretched and the lower part of the screen is superimposed on the top half.
- The "line interleaved" mode can be used with a new type of frame splitter at the line level. In this case the odd lines from one stereo-image are interleaved with the even lines of another. The side-effect of this mode is that the intensity is reduced in half since at each moment one sees only one half of the lines. The splitter device for this mode can be purchased from Virex (www.virex.com). This mode produces a dark stereo image but is easily available (requires stereo goggles, e.g. from Virex).
- The "in-a-window" mode is used in SGI workstations and in a Linux workstation with an advanced graphics card supporting a quad graphics buffer. In this mode the hardware stereo regime applies only to an OpenGL window. This is the best mode but it requires an expensive graphics card (plus the stereo goggles).

GRAPHICS.surfaceDotDensity - Determines the number of dots per square Angstrom on the graphical solvent accessible surface.

GRAPHICS.surfaceProbeRadius - An increment to the van der Waals radii of atoms at which the dotted atomic surface is calculated. It is used by the display surface command to display dotted van der Waals surface. If the GRAPHICS.surfaceProbeRadius is set to 1.4 the surface becomes equivalent to the solvent accessible surface with a probe of 1.4A

GROB.arrowRadius - a real arrow radius in Angstroms used by the Grob("ARROW", R_) function. Default: 0.5.

GROB.contourSigmaIncrement - a real increment in the sigma level used to re-contour an electron density map using the `make_grob m_ed add r_increment` command. This parameter is used in the GUI when plus and minus are pressed.

GROB.relArrow Size - a real ratio of the arrow head radius to the arrow radius. This parameter is used by the `Grob("ARROW", R_)` function. Default: 3.0.

shineStyle - defines how solid surfaces of cpk, skin and grobs reflect light. Possibilities:

1. "white" <- default
2. "color"

The first option gives a more shiny and greasy look.

GRAPHICS.center Follows Clipping - determine the function of center button.

GRAPHICS.clashWidth - relative width of a displayed clash.

GRAPHICS.clip Skin - enable skin clipping.

GRAPHICS.displayMapBox - controls if the bounding box of a map is displayed

GRAPHICS.light - a rarray of 13 elements between 0. and 1. which controls the main properties of lighting model in GL.

GRAPHICS.mapLineWidth - relative width of lines and dots of a displayed map.

GRAPHICS.occupancy Radius Ratio - preference controlling the radius of the partial or zero atom occupancies

GRAPHICS.resize Keep Scale

GRAPHICS.selectionStyle - preference for the style in which the graphical selection is shown. The preference may have the following values.

GRAPHIC.store Display - maintains representation and coloring for an object.

GRAPHICS.surfaceDotSize - Determines the size of the dot on the solvent accessible graphical surface.

GRAPHICS.transparency - Two parameters regulating the transparency of grobs.

GROB.atomSphereRadius - default radius (in Angstroms) which is used to select a patch on the surface of a grob.

GROB.relArrowHead - a real ratio of the arrow head radius to the arrow radius.

lineWidth - the real width of lines used to display the wire representation of chemical bonds.

3.7.4 GUI Preferences

GUI TAB:

The options contained within the Preferences/Gui tab are described below.

GRAPHICS.alignment Rainbow - This option controls how alignments are colored by default.

GRAPHICS.NtoC Rainbow - Controls the coloring of structural representation from the N-terminal to the C-terminal

GRAPHICS.rocking - Controls default rocking motion.

GRAPHICS.rocking Speed - Controls rocking or rotation speed.

GUI.auto Save Interval - Controls auto save period (minutes)

GUI.table Row Mark Colors - Controls colors used for marking tables.

GUI.workspaceTabStyle - Controls the style of ICM-object tabs created in the workspace panel of ICM GUI.

Movie.fade Nof Frames - Controls number of frames for the fade out option in screenshot movie making.

Movie.quality - Controls the resolution of the movie

SEQUENCE.site Colors - Controls coloring of sequence sites.

SLIDE.ignore Fog - Fog representations can be ignored in slide preparation if desired.

GRAPHICS.discrete Rainbow -

GRAPHICS.rainbow Bar Style - determines if and where the color bar will appear after a molecule is colored by an array.

GRAPHICS.rocking Range - real value of rocking range.

GUI.auto Save - auto save on or off

GUI.max Sequence Length - maximum sequence length displayed in ICM

GUI.workspace Folder Style - Workspace folder style.

MOVIE.frame Grab Mode - with screenshot movie making you can choose either fixed frame time or real time.

Movie.quality Auto - with screenshot movie making you can allow ICM to control the movie resolution.

SLIDE.ignore Background Color - Ignore background color when you are making a slide.

3.7.5 GUI Preferences

To change GUI Preferences:

- Select File/Preferences.
- Choose the **GUI** tab.

Quality - controls the quality (density of graphical elements) of such representations as cpk, ball, stick, ribbon . Do not make it larger than about 20 or smaller than 1. We recommend to make this parameter at least 15 if you want to make a high quality image. You can also increase the number of image resolution by making the image window 2,3,4 times larger (in the example below it is 2 times larger) than the displayed window.

Wire Style - Four different wire styles are available.

Hydrogen Display - Select whether you always want all hydrogens displayed or just-polar hydrogens or no hydrogens at all.

Rainbow Scale - determines if and where the color bar will appear after a molecule is colored by an array. Coloring by an array is one of the options of the display and color commands.

```
1. = "left" <- default choice
2. = "right"
3. = "no text"
4. = "no bar"
```

Ball Ratio - The ratio of ball and stick radii. This ratio is applied when the styles are switched to xstick from the GUI xstick toolbar.

Selection Style - Change the graphical display of your selections. Default is a green cross.

Clash Threshold - a clash is defined as an interatomic distance less than a sum of van der Waals radii of two atoms of interest multiplied by the clashThreshold parameter. For hydrogen bonded atoms, the distance threshold is additionally reduced by 20% . Default = 0.82

DotSurfaceRadiusIncrement - radius of a probe sphere used to display a dotted surface of a molecule. All van der Waals radii are expanded by this value. vwExpand=0 corresponds to the CPK surface, vwExpand=1.4 corresponds to the water-accessible surface. Be aware of the difference between the waterRadius and vwExpand parameters: waterRadius is used in

- show energy "sf"
- show [area|volume] skin
- display skin while vwExpand is used in
- show [area|volume] surface
- display surface

Default (1.4).

H Bond Style - How do you wish your H-Bonds to be displayed by default? Dashes, Bond Length, Bond Length and Angle.

grobLineWidth - relative width of displayed lines of 3D meshes (grobs). Also affects the interatomic distance display.

general line with - the real width of lines used to display the wire representation of chemical bonds. See also IMAGE.lineWidth parameter which controls line thickness in molecular images generated by the write postscript command, and the PLOT.lineWidth which controls the width for the plot command. Default (1.0)

single atom as - display style of isolated atoms in the wire mode.

```
1. "tetrahedron"
2. "cross"
3. "dot"
```

The size of the first two representation is controlled by the GRAPHICS.ballRadius parameter and

xstickhetatomzZoom - The default ball and stick radii of a ligand can be different. This makes a better ligand view since the ligand stands out from the surrounding protein atoms.

solid shine style - choose either white or color

Stick Radius - radius (in Angstroms) of a cylinder displayed as a part of stick or xstick graphical representation of a molecule. Individual (residue-wide) control of stick radii.

Stereo Mode - Select a default stereo mode

Display Style - A default display style can be chosen using a combination of styles.

Water Radius - radius of water sphere which is used to calculate an analytical molecular surface (referred to as skin) as well as the solvent-accessible surface (centers of water spheres).

clashWidth - relative width of a displayed clash.

hbondWidth - relative width of hydrogen bond display

mapLineWidth - relative width of lines and dots of a displayed map.

3.7.6 Image Preferences

To change Image Preferences:

- Select File/Preferences.
- Choose the **Image** tab.

IMAGE.color - logical to save color or black_and_white ('bw') images.

IMAGE.gammaCorrection - real variable to to lighten or darken the image by changing the gamma parameter. A gamma value that is greater than 1.0 will lighten the printed picture, while a gamma value that is less than 1.0 will darken it.

IMAGE.lineWidth - this real parameter specifies the default line width for the postscript lines.

IMAGE.orientation - image orientation.

IMAGE.previewer - a string parameter to specify the external filter which creates a rough binary (pixmap) postscript preview and adds it to the header of the ICM-generated high resolution bitmap or vectorized postscript files saved by the write image postscript, and write postscript , respectively .

IMAGE.print - unix command for printer.

IMAGE.scale - real variable. If non zero, controls the image scale with respect to the screen image size.

IMAGE.stereoBase - real variable to define the stereo base (separation between two stereo panels) in the write image postscript and write postscript command.

IMAGE.writeScale - an integer parameter used to increase the image resolution in the Quick Image Write tool.

IMAGE.bondLength2D - real length of a chemical bond (in inches) in chemical 2D drawings upon the Copy Image command.

IMAGE.compress - logical to toggle simple lossless compression, standard for .tif files. This compression is required to be implemented in all TIFF-reading programs.

IMAGE.generateAlpha - logical to toggle generation of the alpha (opacity) channel for the SGI rgb, tif and png image files to make the pixels of the background color transparent.

IMAGE.lineWidth2D - integer thickness of bonds in chemical 2D drawing upon the Copy Image command. This is useful for cutting and pasting from ICM to external documents.

IMAGE.paper Size - specify paper size.

IMAGE.previewResolution - integer resolution of the rough bitmap preview added to the vectorized postscript file in lines per inch.

IMAGE.printerDPI - this integer parameter the printer resolution in Dot Per Inch (DPI). Important for the write image postscript command.

IMAGE.stereoAngle - real variable to define stereo angle (relative rotation of two stereo images) in the write image postscript and write postscript command.

IMAGE.stereoText - logical to make text labels for only one panel or both panels of the stereo diagram.

3.7.7 Label Preferences

To change Label Preferences:

- Select File/Preferences.
- Choose the **Labels** tab.

atomLabelStyle style of atom labels invoked by clicking on an the atom label button.

GRAPHICS.displayLineLabels - enables/disables the display of edge lengths (inter-point distances) of a grob generated with the Grob("distance" ..) function.

GRAPHICS.font Line Spacing - Change the spacing between lines in labels.

GRAPHICS.resLabelDrag - if yes, enables dragging of the displayed residue labels with the middle mouse button.

GRAPHICS.site Arrow - Highlight sites with an arrow yes or no.

Show Res Code In Selection - When you make a selection the icm selection language will be displayed when you right click on the selection.

Res Label Style - Default residue label style.

SITE.label Style - Default label sites style.

Var Label Style - Default label variable style.

GRAPHICS.atomLabelShift - a non-negative integer number of spaces preceding an atom label. This parameter is useful for displaying labels next to a solid representation,

GRAPHICS.fontColor - set font color

GRAPHICS.font Scale - set font size

GRAPHICS.site Label Shift - GRAPHICS.resLabelShift a non-negative integer number of spaces preceding a site label.

GRAPHICS.site Label Drag - if yes, enables dragging of the displayed site labels with the middle mouse button.

Res Label Shift - a non-negative integer number of spaces preceding a residue label. This parameter is useful for displaying residue labels next to a solid

SITE.labelOffset - (default 5. A) the real offset of the site label with respect to the residue label atom.

SITE.wrap Comment - Number of characters per comment line.

3.7.8 Plot Preferences

To change Plot Preferences:

- Select File/Preferences.
- Choose the **Plot** tab.

PLOT.color - logical to generate a color plot. Usually it does not make sense to switch it off because your b/w printer will interpret the color postscript just fine anyway.

PLOT.draw Tics logical yes or no

PLOT.fontSize real font size. Any reasonable number from 3. (1 mm, use a magnifying glass then) to 96.

PLOT.lineWidth - real line width for graphs (not the frame and tics)

PLOT.markSize - real mark size in points. Allowed mark types: line, cross, square, triangle, diamond, circle, star, dstar, bar, dot, SQUARE, TRIANGLE, DIAMOND, CIRCLE, STAR, DSTAR, BAR. Uppercase words indicate filled marks.

PLOT.paper Size - preference to specify plot paper size

PLOT.rainbowStyle - preference defining the color spectrum used by the plot area command.

PLOT.Yratio - real aspect ratio of the ICM plot frame. Using link option of the plot command is equivalent to setting this variable to 1.0. If PLOT.Yratio is set to 0. , the ratio will be set automatically to fill out the available box optimally.

[PLOT.date] - display date on plot

PLOT.font - preference for the title/legend font.

PLOT.labelFont - preference for the data point label font.

PLOT.logo - logical switch for the ICM-logo on the plot.

PLOT.orientation - preference for the plot orientation.

PLOT.previewer - command to local ps viewer

PLOT.seriesLabels - preference to indicate position of a series/color legend inside the plot frame.

3.7.9 Ribbon Preferences

To change Ribbon Preferences:

- Select File/Preferences.
- Choose the **Ribbon** tab.

Combo Display Style - select ribbon-cpk, atoms, ribbon-ligand, chemical

GRAPHICS.dnaRibbonRatio - real ratio of depth to width for the DNA ribbon .

GRAPHICS.dnaRibbonWorm - logical which, if yes, makes the DNA backbone ribbon round, rather than rectangular. Default: no

GRAPHICS.dnaWormRadius - real radius of the worm representing bases in DNA ribbon .

GRAPHICS.ribbonWidth - real width of the protein ribbon .

GRAPHICS.wormRadius - radius of coiled segments (i.e. those where the secondary structure is marked as "_") of a polypeptide chain in ribbon representation. Default (0.3).

Ribbon Style - specifies default style when `ribbon` is displayed.

GRAPHICS.dnaBallRadius - DNA bases in ribbon representation are shown as balls controlled by this real parameter.

GRAPHICS.dnaRibbonWidth - real width (in Angstroms) of the DNA ribbon .

GRAPHICS.dnaStickRadius - real radius of the sticks representing bases in DNA ribbon .

GRAPHICS.ribbonRatio - real ratio of depth to width for the protein ribbon .

GRAPHICS.ribbonWorm - logical parameter, if yes, makes the ribbon round, rather than rectangular.

ribbonColorStyle -

- sets the ribbon coloring scheme.

1 = "type" default. colors by secondary structure type or explicit color

2 = "NtoC" colors each chain gradually blue-to-red from N- to C- (or from 5' to 3' for DN

3 = "alignment" if there is an alignment linked to a protein, color gapped backbone regions gr

4 = "reliability" 3D gaussian averaging with `selectSphereRadius` of alignment strength in

If `ribbonColorStyle` equals to 4, the conserved areas will be colored blue, while the most dive

3.7.10 Shell Preferences

To change Shell Preferences:

- Select File/Preferences.
- Choose the **Shell** tab.

Clash Threshold - a clash is defined as an interatomic distance less than a sum of van der Waals radii of two atoms of interest multiplied by the `clashThreshold` parameter.

Map Sigma Level - (in Rmsd values over the mean value). Margin value used for making graphical objects contouring the 3D density map .

Mnconf - maximal number of conformations in the conformational stack . The stack stops growing after this number is achieved and starts replacing representative conformations with higher energy values by new conformations with superior energies, if the latter are found.

Icm Prompt - defines the ICM-prompt string.

Select Min Grad - default minimal gradient vector length for gradient atom selection (`a_//G`). This parameter is also used by the `montecarlo` fast command, which requires a value of 2. to 10. for optimal performance.

Map Atom Margin - Margin in Angstroms around selected atoms. The margin is added to the positional boundaries to define a submap index box in the `Map (map_source , as_)` function.

maxColorPotential - local electrostatic potential in kcal/e.u.charge units at which the surface element is colored by extreme red or extreme blue. All higher values will have the same color. This absolute scaling is convenient to develop a feeling of electrostatic properties of molecular surfaces.

mnSolutions - this parameter limits the number of hits retained by the program after a search.

Real Format - format of real numbers

Water Radius - radius of water sphere which is used to calculate an analytical molecular surface

3.7.11 System Preferences

To change System Preferences:

- Select File/Preferences.
- Choose the **System** tab.

FTP.createFile -

FTP.proxy - string path to the proxy server for connections through firewall. Default: "" (empty string).

GUL.max Nof Recent Files - maximum number of `recent files` stored.

GUL.splash Screen Image - path to splash image displayed on startup

HTTP.support Cookies - http support cookies yes or no

HTTP.user Agent - client application used within a particular network protocol for www

Beep - warning beep yes or no

Max File Size Mb - Maximu file size in MegaBytes that can be loaded into ICM.

USER.friends

USER.organization

FTP.keep File - (default no). If yes, the temporary file is kept in the `s_tempDir` directory. Otherwise the file is deleted.

GUL.enumeration Memory Limit - memory limit for enumeration operations.

GUL.splash Screen Delay

HTTP.proxy - string for HTTP server for connection through firewall

HTTP.timeout - timeout in seconds

Http Read Style icm or lynx

Force Auto Bond Typing - yes/no

USER.email, USER.full Name, USER.phone

4 Protein Structure



Chapter Contents:

- How to Convert Proteins and Chemicals to ICM Objects.
- Binding Site Display Tools.
- Crystallographic Analysis Tools.
- Protein Superposition.
- Protein Structure Analysis.
- Protein Structure Prediction Tools e.g. ICM Pocket Finder.

4.1 Convert to ICM Object

Available in the following product(s): ICM-Browser | ICM-Browser-Pro
| ICM-Pro | ICM-Chemist

4.1.1 Load a Protein Structure

There are a couple of ways to read into ICM a protein structure.

1. Search the PDB using the [Search Tab](#).
2. Load in a PDB file that you have saved on your computer using [File/Open](#).

4.1.2 Converting PDB Files Into ICM Objects

If you are going to make any type of energy calculation in ICM (eg docking, display H-bonds, display electrostatic and binding property surfaces etc..) it is necessary to convert a protein or chemical into an ICM object. Be aware that upon conversion ICM adds missing side-chain atoms (but wont try to build missing loops) due to the nature of the internal-coordinate system. The list of residues/ atoms added is presented in the command line shell and can be reviewed. For reference, the original PDB entry is kept in the system. See the command line manual for a more complete description of what the conversion process does.

NOTE: Before converting a protein structure to an ICM object make sure that the chemicals contained within the structure (e.g. ligands) are correct. If an error is found you can edit the ligand as described here.

To convert a PDB structure into an ICM object follow the steps shown below:

- Right click on the name of the protein you wish to convert in the ICM Workspace.
- A dialog box will be displayed as shown below.
- If you want to delete the water molecules select **Delete Waters**
- If you want to optimize hydrogen atoms (recommended for important work) select **Optimize Hydrogens**. This option performs global optimization of hydrogens to find the best hydrogen bonding network.
- If you want to optimize the orientation of His, Pro, Asn, Gln, Cys residues then choose **optimizeHisProAsnGlnCys**. The following residues will be further optimized: His - three protonation states and two rotations will be tried and the residue will be renamed according to its subtype: hie (epsilon tautomer) or hip (+). Asn and Gln - (a 180 deg. flip will be tried). Cys - in the vicinity of Zn, Cu, Fe and Co to cym.
- If you want to keep a copy of your PDB file uncheck the option **replace original**.
- The converted structure can be displayed immediately by checking **display the result**
- **Uncheck** the box **hide missing side chains** if you want ICM to build missing heavy atoms that are not reported in the PDB (due to the lack of density), they will be added according to the residue name and assigned zero occupancies. **Check** this box if you want residues missing heavy atoms to be hidden.

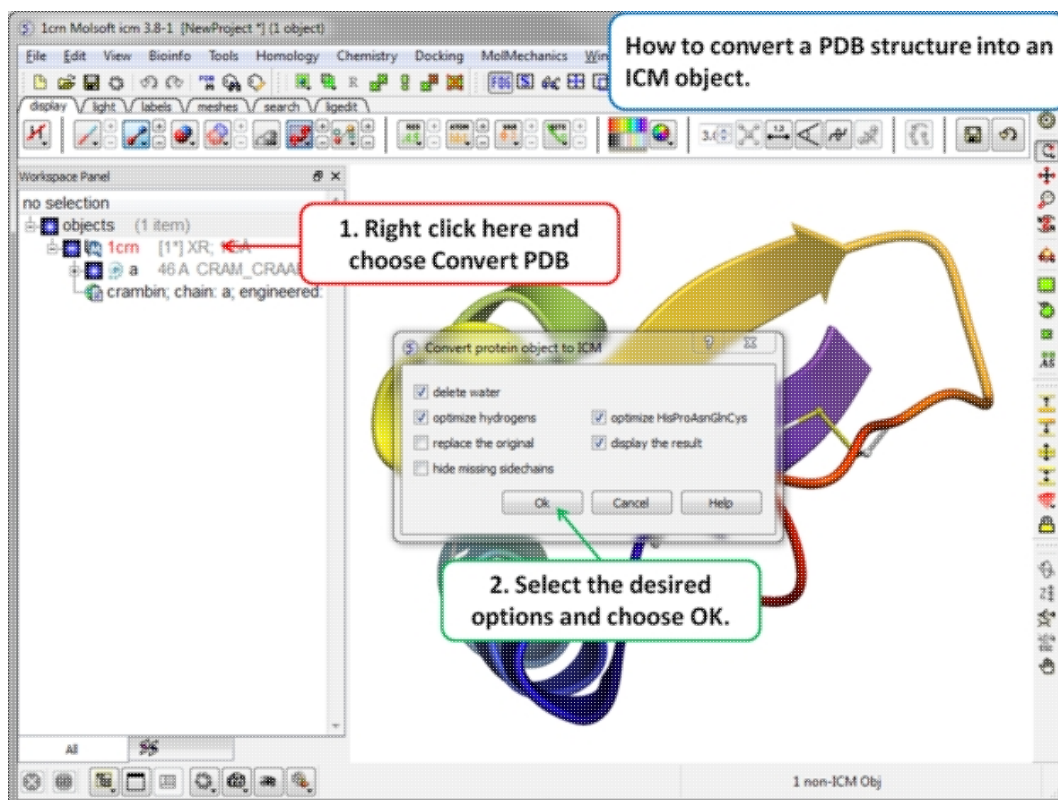

If your object is an ICM object it will display **ICM** next to the molecule in the ICM Workspace.

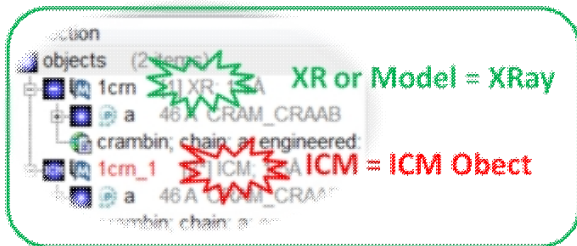

4.2 Pocket Display

Available in the following product(s): ICM-Browser | ICM-Browser-Pro
| ICM-Pro

4.2.1 Receptor Pocket Surface.

To display the Receptor Pocket Surface:

- As an example we will use the PDB structure 1STP. Type 1STP in the `pdb search` tab and press return.
- Convert the protein to an ICM object. If you do not convert a generic surface will be displayed that is not colored by binding property.
- Right click on the ligand "abtn" and select **Pocket/Receptor Pocket**.
- Select whether you would like to display side-chain hydrogen bonds and label.
- The receptor pocket will be displayed colored by binding property - White=aromatic lipophilic, Green=non-aromatic other (mostly aliphatic) lipophilic surface, Red=hydrogen bonding acceptor potential, Blue=hydrogen bond donor potential.
- The surface can be toggled on and off by selecting in the ICM Workspace in the **meshes** section.

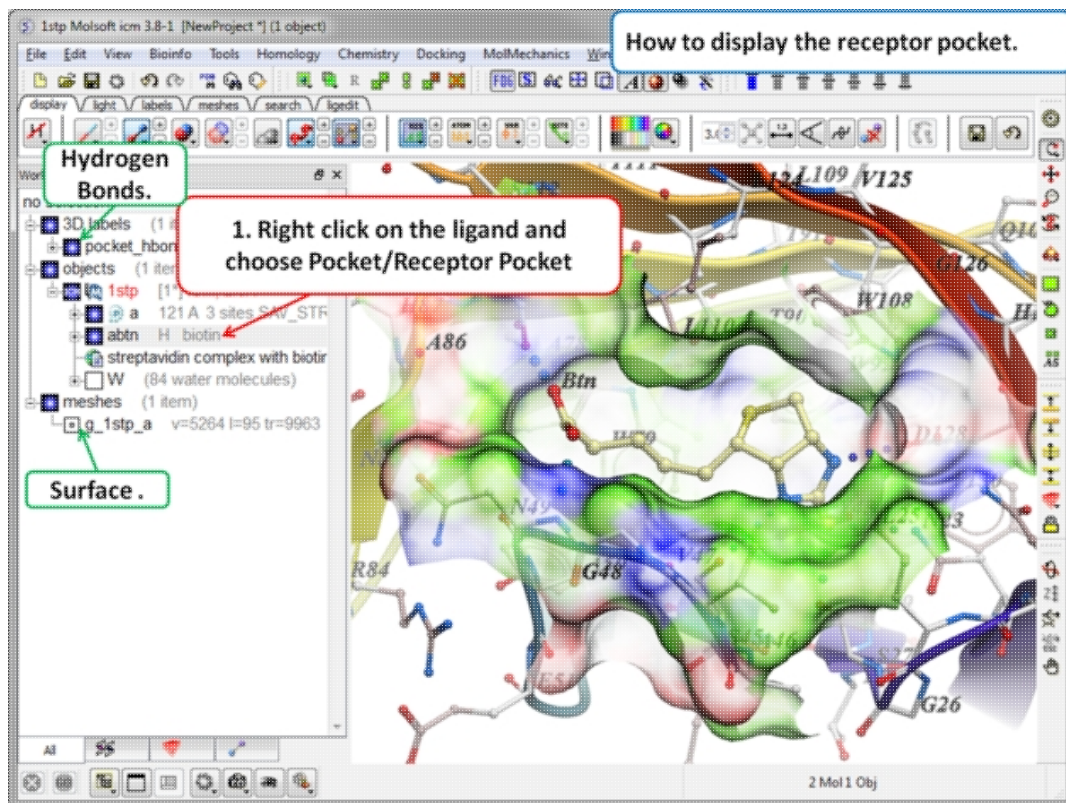

4.2.2 Ligand Surface.

The Ligand Surface option allows you to visualize cavities that are open for ligand modifications. To display the Ligand Surface:

- As an example we will use the PDB structure 1STP. Type 1STP in the `pdb search` tab and press return.
- Convert the protein to an ICM object. If you do not convert a generic surface will be displayed that is not colored by binding property.
- Right click on the ligand "abtn" and select **Pocket/Ligand Surface**.
- The Ligand Surface will be displayed colored by binding property - White=aromatic lipophilic, Green=non-aromatic other (mostly aliphatic) lipophilic surface, Red=hydrogen bonding acceptor potential, Blue=hydrogen bond donor potential.

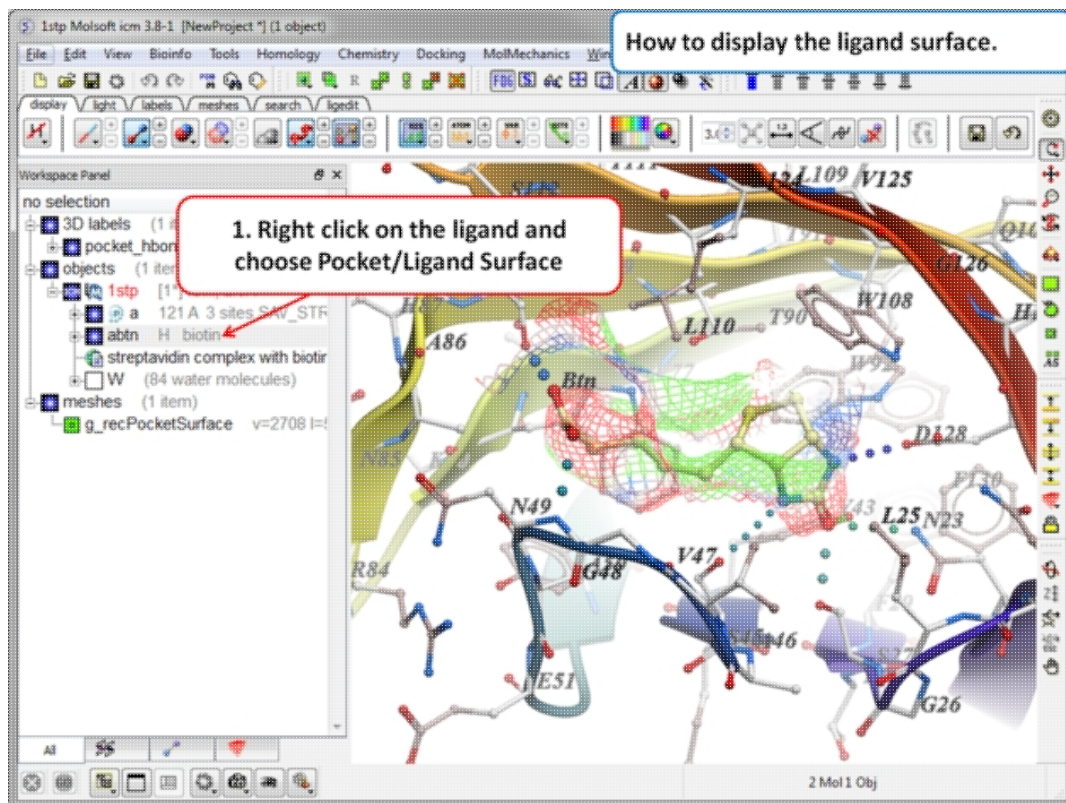

4.2.3 How to Display Hydrogen Bonds

NOTE: The method by which hydrogen bonds are calculated is described here in the command line manual. The GRAPHICS.hbondMinStrength parameter determines the hbond strength threshold for hbond display. The strength value is between 0. and 2. By changing 1. to 0.2 you will see more weak hydrogen bonds.

- In order to display energy related properties we need to convert the PDB file into an ICM object. Convert 1STP into an ICM object. In this example, the option "Replace the Original" was selected.
- Display the receptor in wire format and the ligand in xstick.
- Right click on the ligand and select "Neighbors" - Enter 3 Angstroms and Type = Visible. Do not exclude source (the ligand) therefore remove tick from box entitled "exclude source".
- Select the display tab and then select the Display H-Bond button.

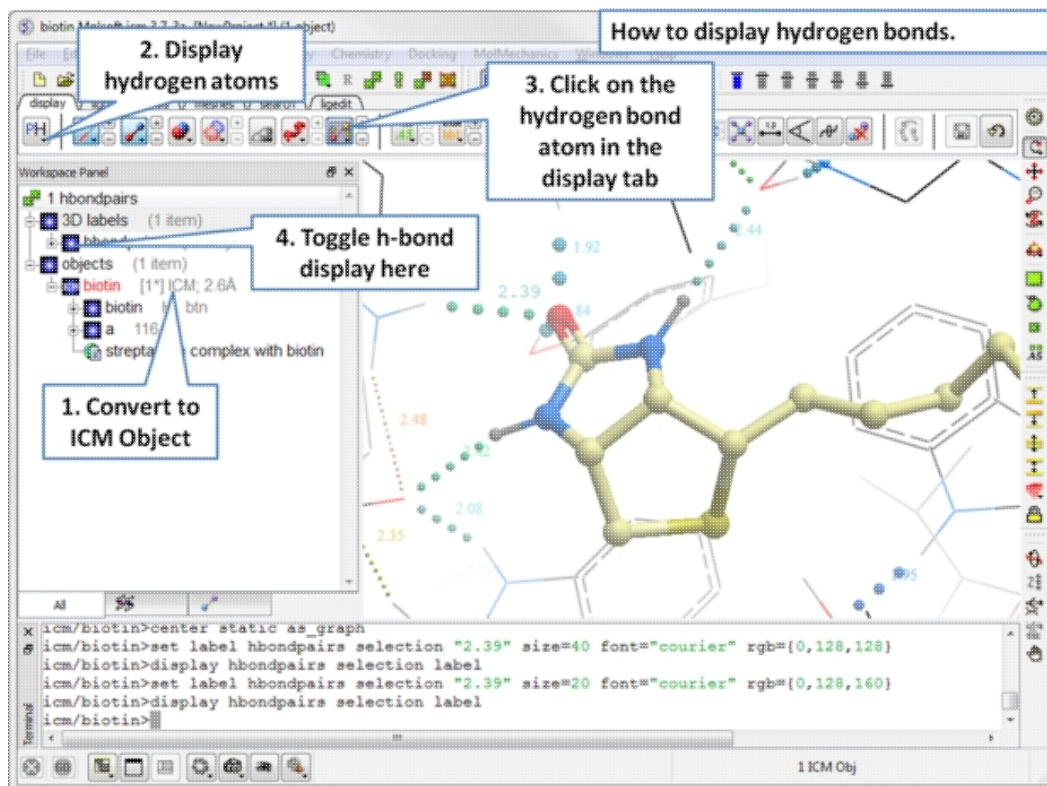

NOTE: Different options for displaying the H-bond can be accessed by clicking and holding on the H-bond button in the "Display" tab. The coloring of the H-bonds are red (strong - thick spheres) to blue (weak - thin spheres). Once the hydrogen bonds have been displayed they can be displayed and undisplayed in the 3D labels section of the ICM Workspace (left hand side of graphical window).

4.2.3.1 Edit Hydrogen Bond Label

To edit a hydrogen bond label

- Right click on the label.
- Choose Edit Label.
- Make changes in the dialog box and press OK.

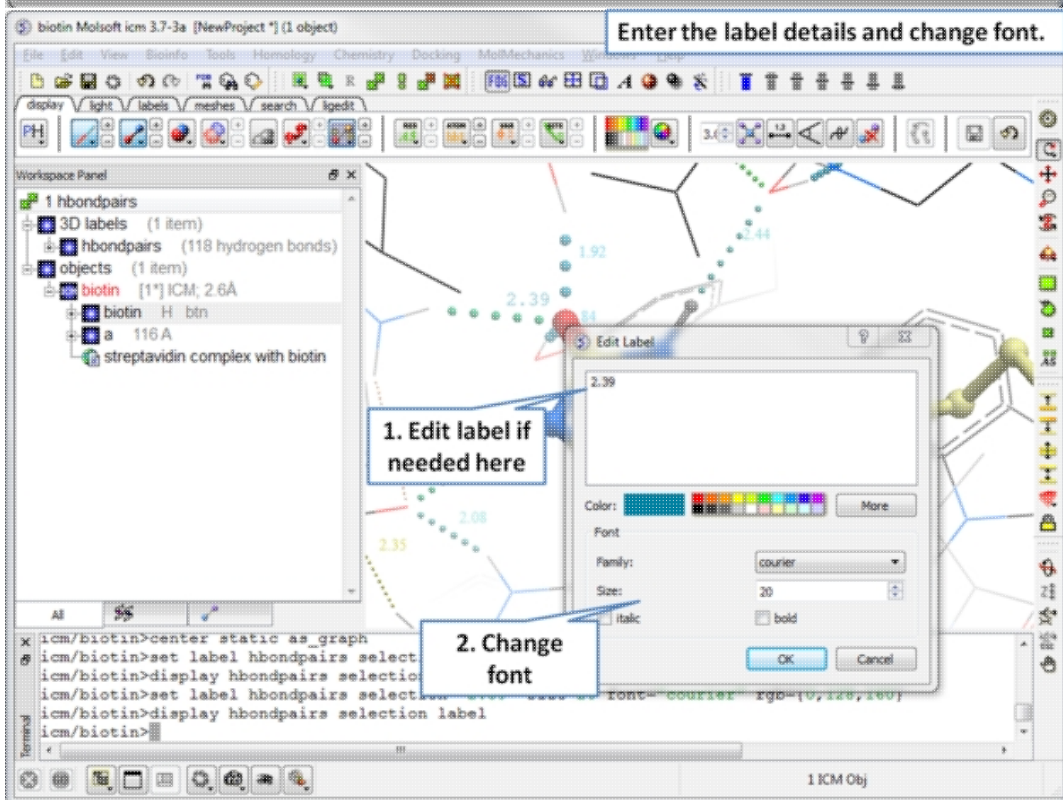
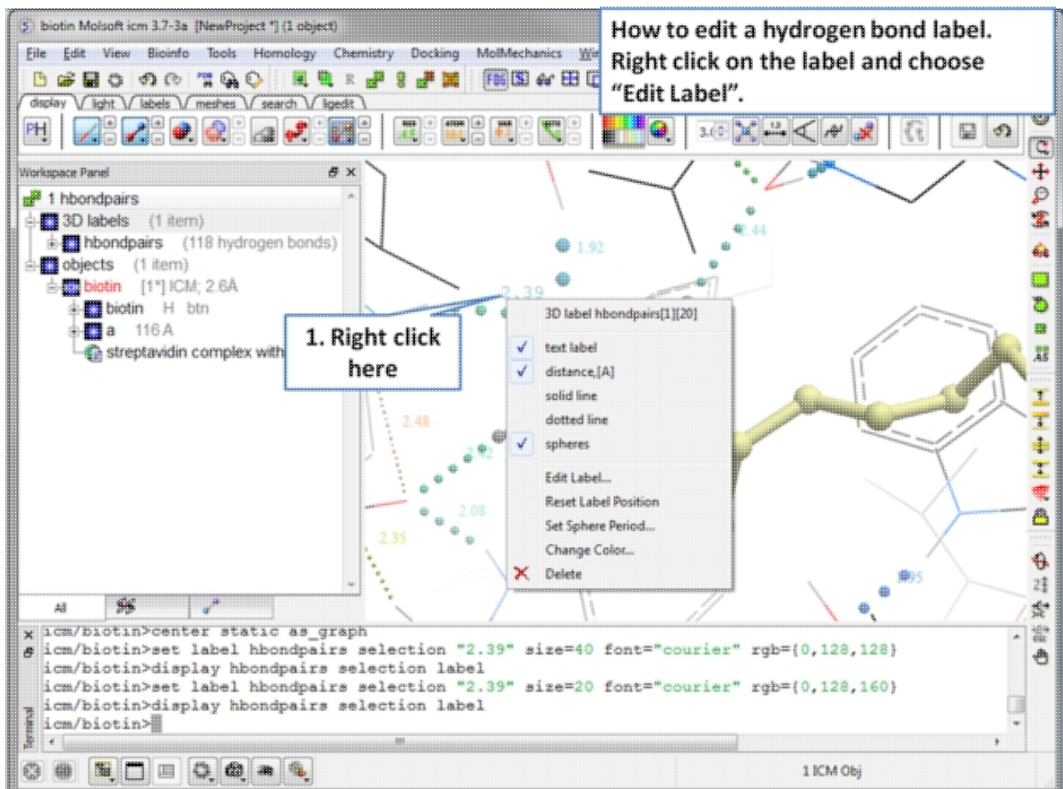

4.2.3.2 Move Hydrogen Bond Label

To move a hydrogen bond label

- Right click on the label.
- Click on the label using the middle mouse button.

4.2.3 How to Display Hydrogen Bonds

- Hold the middle mouse button down and drag.

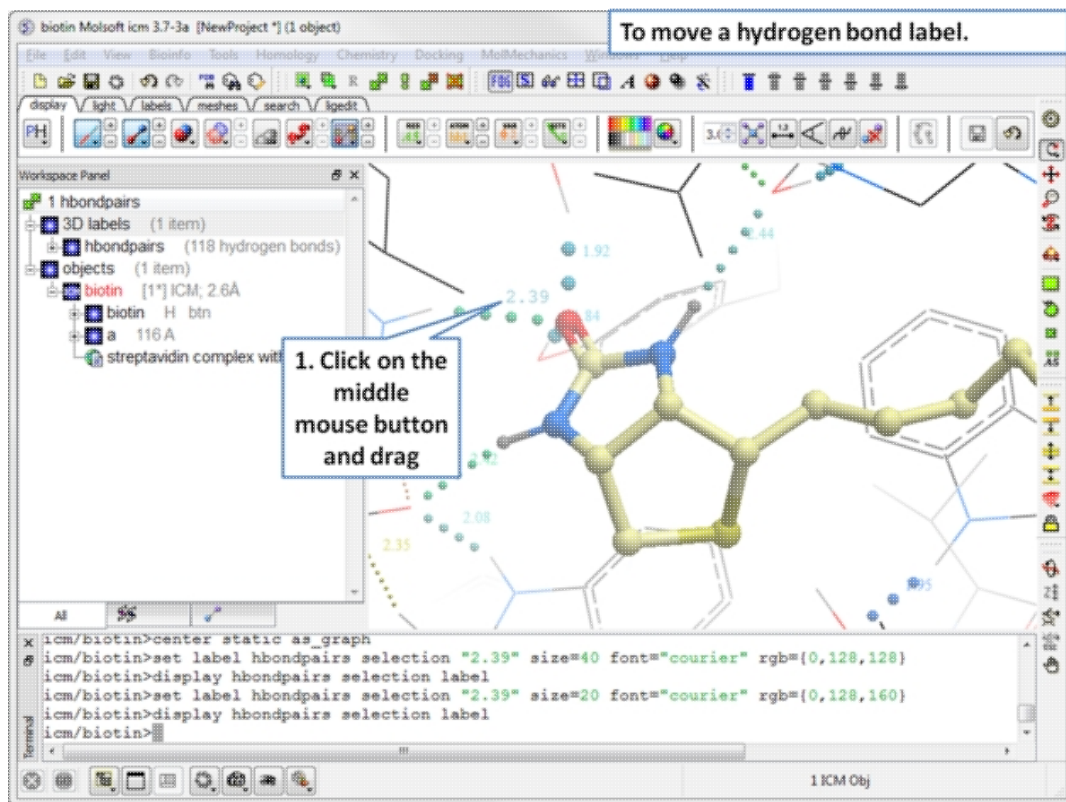

4.2.4 Ligand Pocket Interactions

To view the ligand pocket interactions.

- Right click on the ligand and choose Pocket.
- Choose Ligand Pocket Interactions. Hydrogen bonds, key waters and neighboring residues will be displayed.

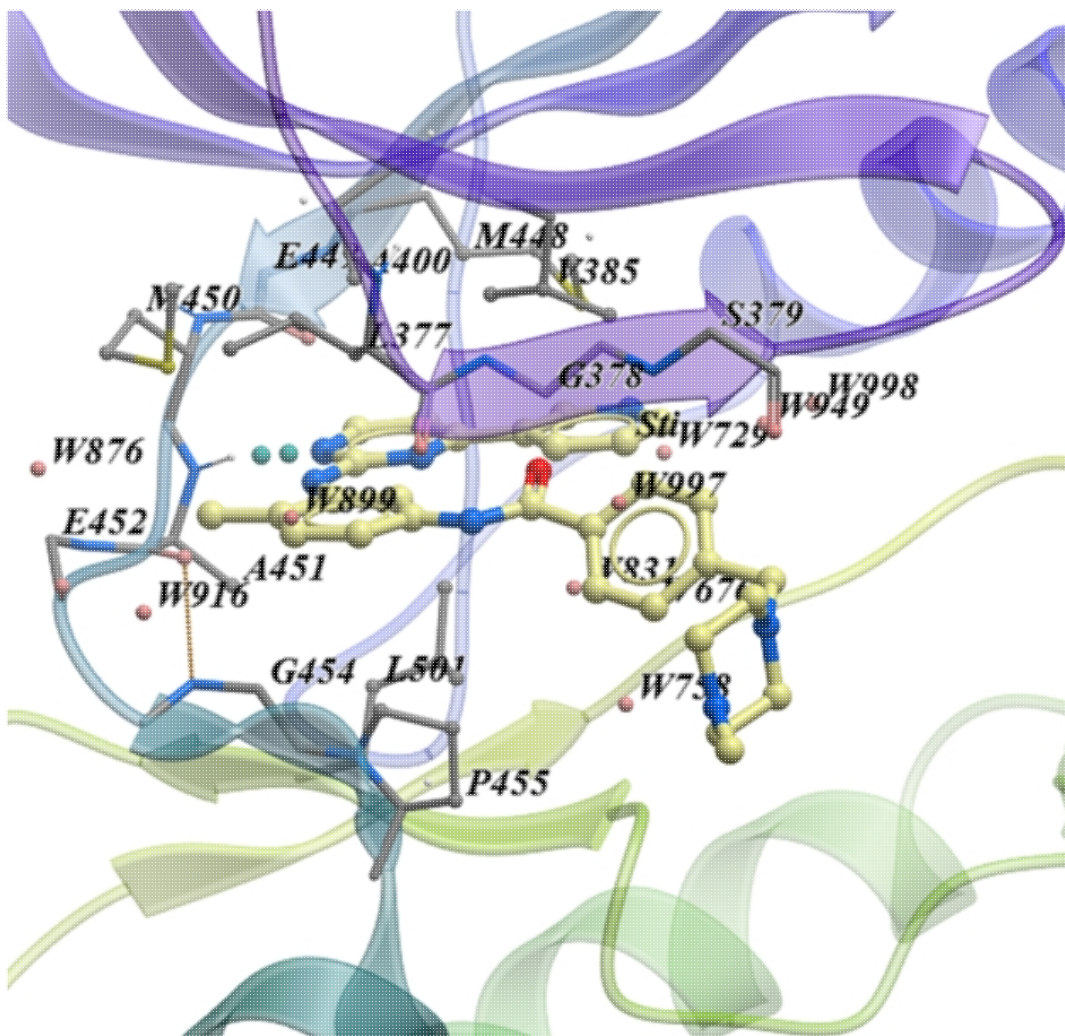

4.3 Crystallographic Analysis

Available in the following product(s): ICM-Browser-Pro | ICM-Pro

4.3.1 Crystallographic Neighbor

Theory

Molecular objects and 3D density maps may contain information about crystallographic symmetry. It consists of the following parameters:

1. Crystallographic group eg. P2121 that determine N (depends on a group) transformations for the atoms in the asymmetric unit.
2. Crystallographic cell parameters A, B, C, Alpha, Beta and Gamma

To generate the coordinates within one cell one needs to apply N transformations and then to generate neighboring cells the content of one cell needs to be translated in space according to the cell position.

ICM has a function which generates crystallographic neighbors for the selected atoms. For large proteins it is impractical to generate neighbors for the whole molecule due to the high number of atoms in all neighboring molecules.

This information allows to generate symmetry related parts of the density or molecular objects.

To generate symmetry related molecules around a selection of atoms:

- Read a PDB file into ICM. For instruction see the section entitled Search PDB.
- Display the structure and select the residues around which the symmetry will be generated. For information on how to select residues see the Making Graphical Selections section.
- Select the menu Tools/Xray/Crystallographic Neighbors.

A data entry box as shown below will be displayed.

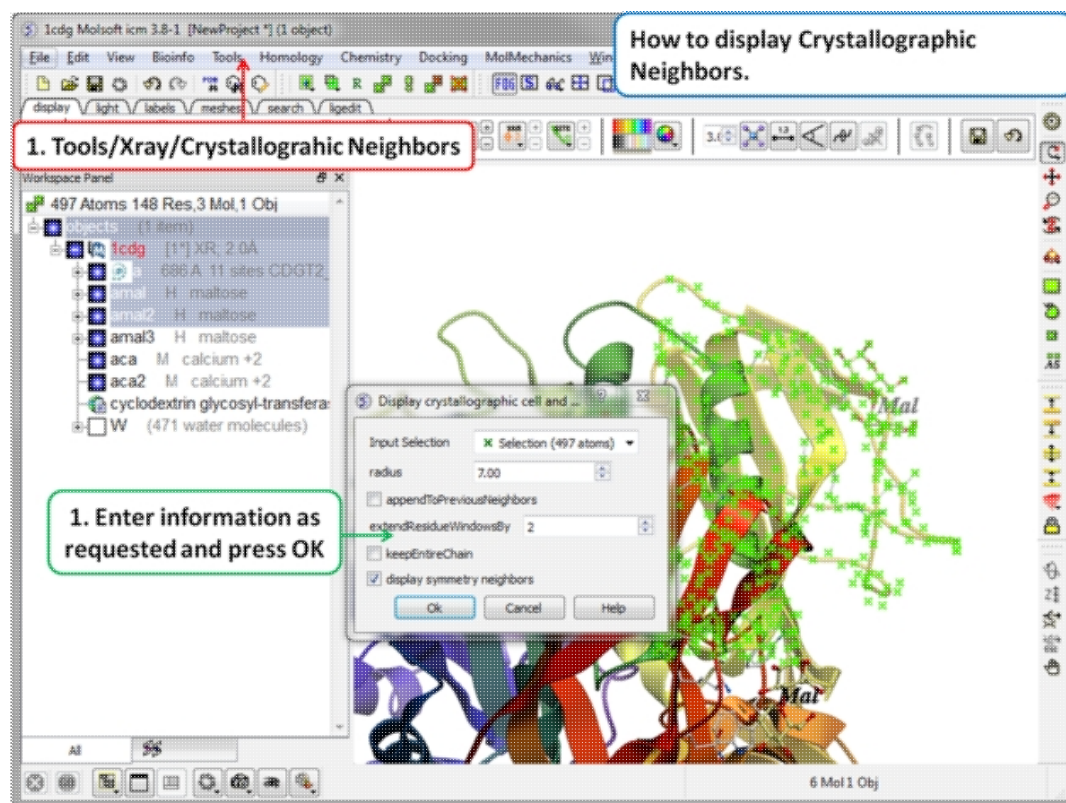

- Check that the selection is correct in the **Input Selection** box.
- Enter the radius around your selection from which you wish to construct the symmetry related molecules.
- If you have made symmetry related molecules previously you can select **appendToPreviousNeighbors** otherwise leave unchecked.
- The **extendResidueWindowsBy** option will allow a window of residues outside of the selection radius selected above to be displayed
- If you leave the **keepEntireChain** unchecked then a fragment of each neighbor will be created. If you check this box the full neighbor will be generated
- Check display symmetry neighbors to display them in the graphics window. The nearest neighbor residues will be displayed in xstick representation and the each neighbor colored by molecule.
- Click OK.

The crystallographic symmetry neighbors will be displayed in the Workspace. By default the object will have the object name + "Sym" and each of the neighbors will be individual molecules.

For packing analysis and display you can color each symmetry unit a different color as described in the Structural Representations Color section. This is shown in the picture below.

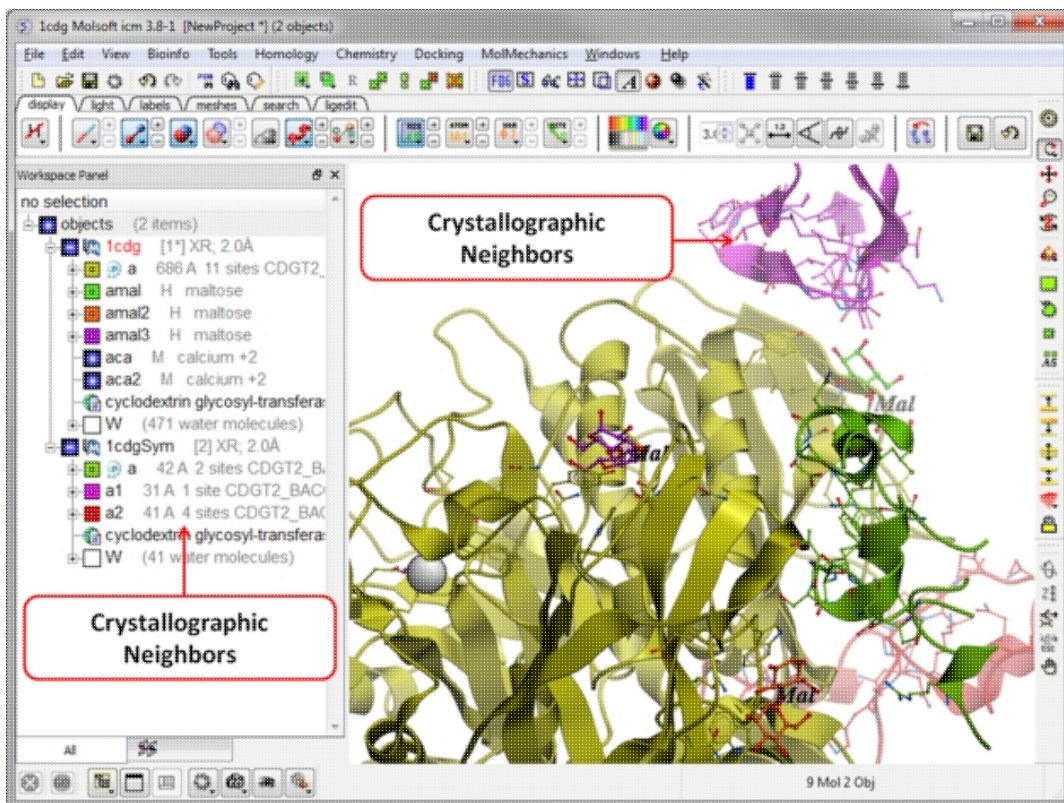

4.3.2 Crystallographic Cell

Theory

The crystal structure of a protein is often discussed in terms of its unit cell. The unit cell is a box containing one or more motifs, a spatial arrangement of atoms. The units cells are tiled in three-dimensional space to describe the crystal. The unit cell is given by its lattice parameters, the length of the cell edges and the angles between them, while the positions of the atoms inside the unit cell are described by the set of atomic positions measured from a lattice point.

To display the crystal cell of a PDB structure:

- Read a PDB file into ICM. For instruction see the section entitled Search PDB.
- Select the whole object. You can do this by double clicking on the name of the structure in the ICM Workspace (a selection is highlighted blue in the ICM Workspace and green crosses in the graphical display) or you can use the right-click button and drag it over the whole structure in the graphical display.
- Select the menu Tools/Xray/Crystallographic Cell and a data entry box will be displayed.
- Click OK

The crystallographic cell will be displayed as a box as shown below.

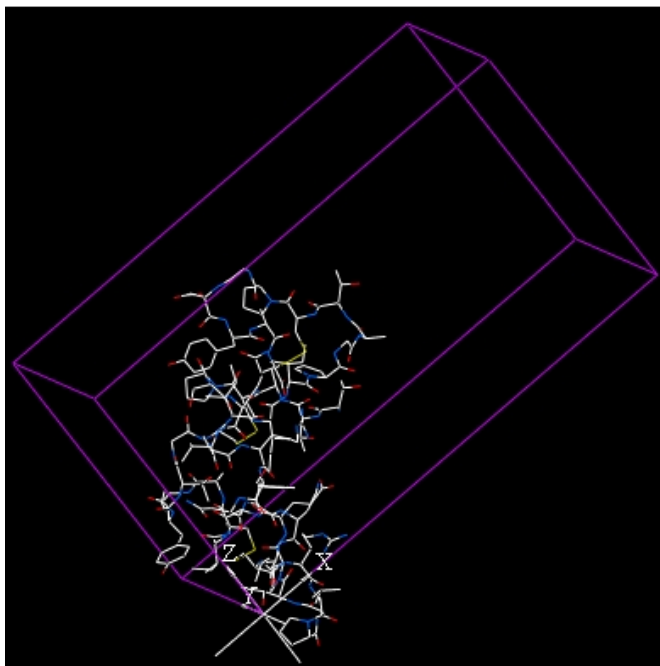

4.3.3 Biomolecule Generator

Theory

It is very useful to know how a protein from the PDB may look in a biological environment. The PDB entries solved by X-ray crystallography and deposited in the PDB contain the information about the crystal structure rather than the biologically relevant structure. For example, for a viral capsid only one instance of capsid protein complex will be deposited and only one or two molecules of haemoglobin that is a tetramer in solution may be deposited.

In some other cases the asymmetric unit may contain more than one copy of a biologically monomeric protein. ICM reads the biological unit information and has a tool to generate a biological unit. Not every PDB entry has the biological unit information.

A gallery of images created using the ICM Biomolecule generator is shown below:

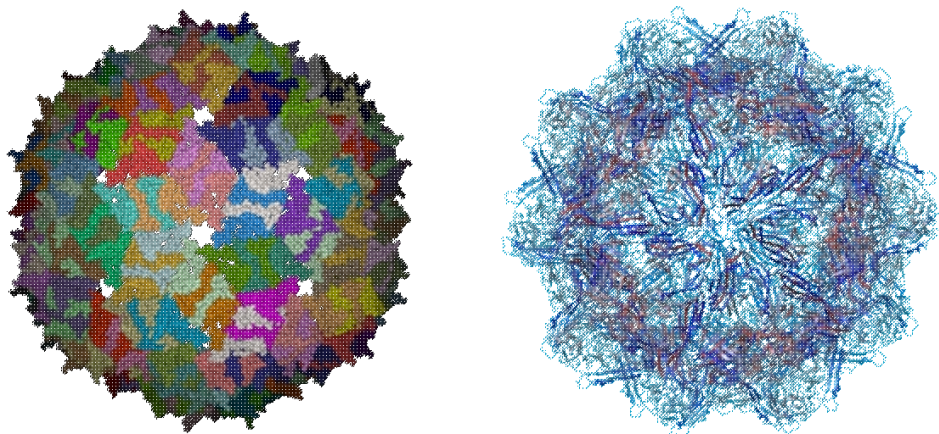

Left: PDB: 1DWN Bacteriophage Pp7 From *Pseudomonas Aeruginosa* At 3.7 Å Resolution **Right:** PDB: 1C8E Feline Panleukopenia Virus Empty Capsid Structure At 3.0 Å Resolution

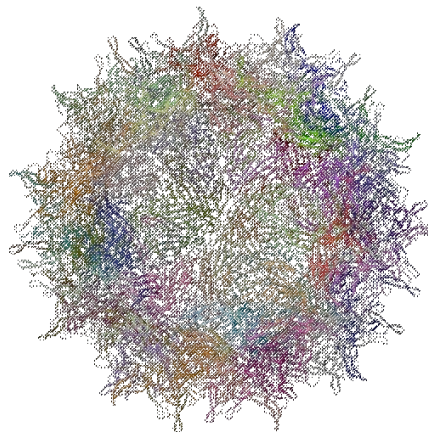
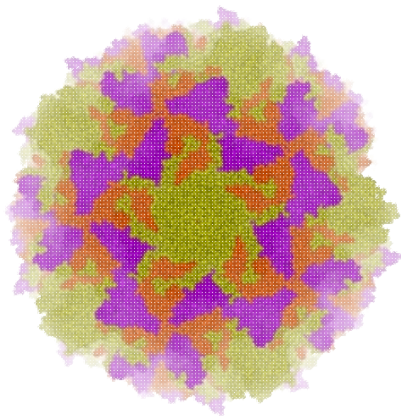

Left: PDB: 1AL2 P1/Mahoney Poliovirus, Single Site Mutant V1160I At 2.9 A Resolution **Right:** PDB: 1LP3 Adeno-Associated Virus (Aav-2), A Vector For Human Gene Therapy At 3.0 A Resolution

NOTE: Right click on a PDB structure in the ICM workspace to determine whether a structure from the PDB has biological unit information. If it does have this information then there will be an option in the menu entitled "Generate Biomolecules" if not the option will be blanked out.

To generate a biological unit with ICM:

- Select the object or PDB file.
- Select the menu Tools/Xray/Biomolecule Generator.
- Tick the **makeAllBiomolecules** box.
- Click OK - with very large molecules the biomolecule generation may take some time.

4.3.4 Get Electron Density Map

Theory

An electron density map is a representation of a crystal structure based on the diffraction data. The map is constructed by a summation of waves of known phase, amplitude and frequency using Fourier transform. The electron density map of a protein can be viewed along with the pdb structure. The easiest way to view the electron density map is to contour and convert it into a graphical object (mesh).

A figure showing the electron density contours surrounding the ATP molecule in pdb entry 1ATP.

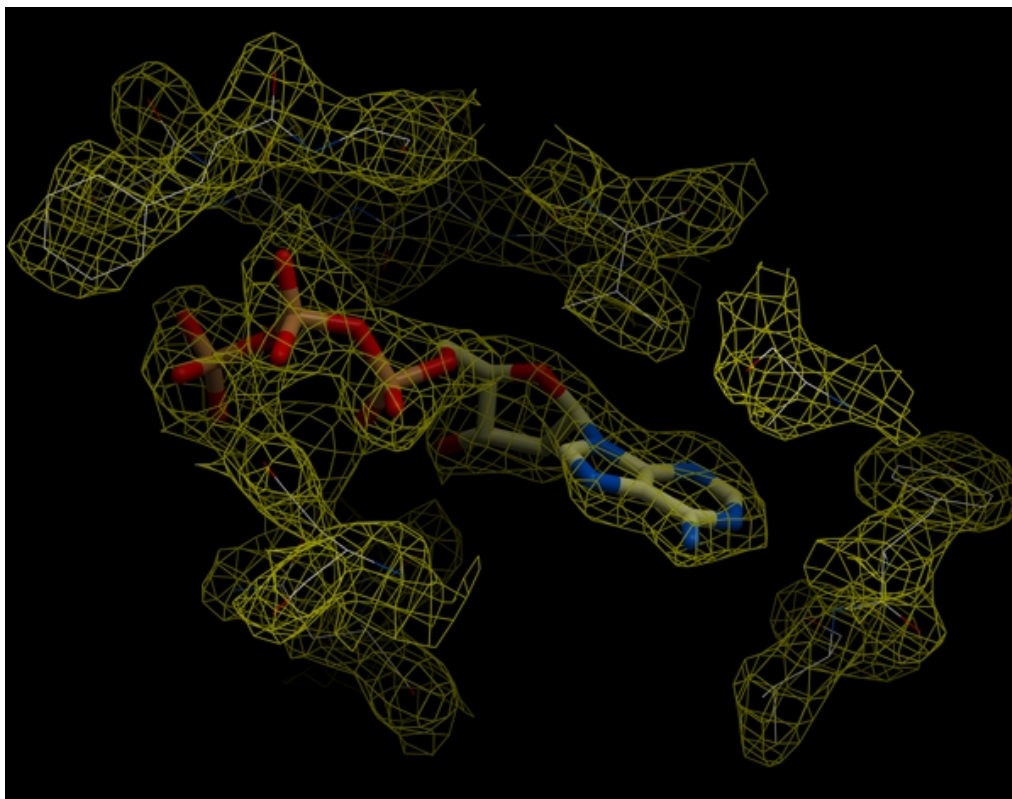

To load an electron density map:

- Tools/Xray/Get Electron Density Map
- Enter the PDB code of the map you would like to view.
- Click OK and the map will be downloaded from the Uppsala Electron Density Server.

The map will be represented in the ICM Workspace as shown below.

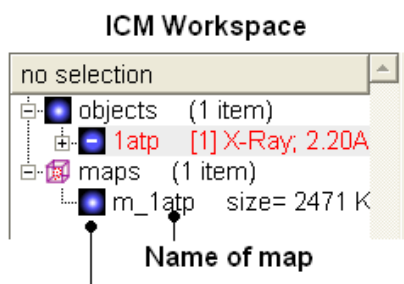

Display and undisplay map here

The map can be displayed as shown below however a clearer way of representing the density is to contour the map into a graphical object (mesh) as described in the following section.

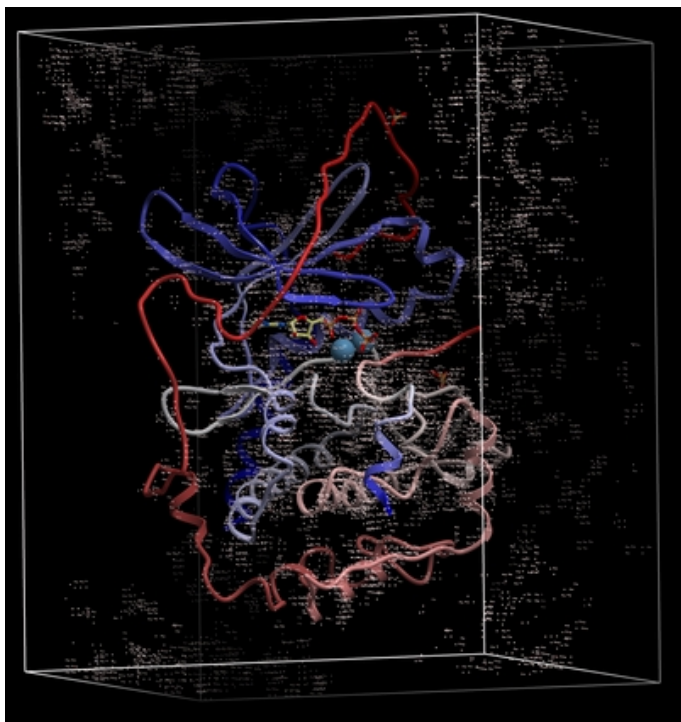

4.3.5 Map's Original Cell

To display the original crystallographic cell of an electron density map:

- Tools/Xray/Map's Original Cell
- Enter the name of the map or use the drop-down button to locate it. If you do not know the name of the map the name can be located in the ICM Workspace.
- Click OK and the cell will be displayed. The map can be displayed and undisplayed in the **meshes** section of the ICM Workspace.

Generated cell

Name of map

4.3.6 Contour Electron Density Map

To contour an electron density map and display as a graphical object:

- Load an electron density map as described earlier in the Load Map section.
- Read in the PDB file - File/Load PDB or use the PDB search tab.
- Tools/Xray/Contour Electron Density.
- Enter the name of the map e.g. m_1cdg - the name of the map is displayed in the ICM Workspace or use the drop down arrow to locate it.

- If nothing is displayed then the whole map will be contoured. If you only want to contour a particular region of the map then you need to select the region to be contoured (e.g. the binding pocket) and then select the option **Trim to Selection Vicinity**.
- Enter a sigmaLevel value for more information see: <http://www.molsoft.com/man/reals.html#mapSigmaLevel>. Once the contoured map has been created the sigma level can be changed manually using the +/- buttons in the ICM workspace. Two contour levels at 1 and 2.5 sigma respectively are generated for the 2Fo - Fc map

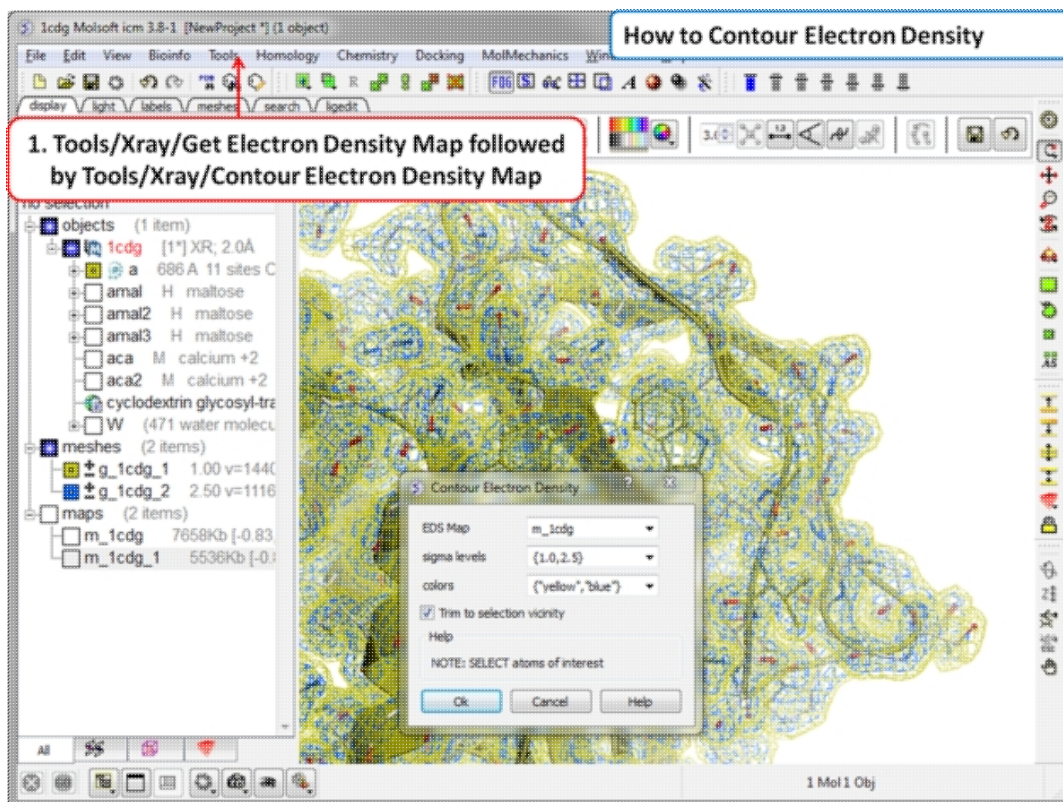

The sigma level can be changed interactively in the ICM workspace as shown below.

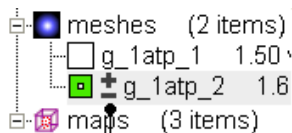

Click here to increase or decrease the sigma level of the contouring

NOTE: Meshes can be cut away using the mesh clipping tools.

4.3.7 Convert Xray Density to Grid

For some applications, such as trying to fit a structure to a density map, you may want to extract a sub map and convert to a grid. You can do this by

- First read into ICM a map (eg File/Open or Tools/X-ray/Get Electron Density Map)
- Tools/X-ray/Convert Xray Density to Grid

- Enter the map name or use the drop down list
- Enter a grid size
- Click OK

4.4 Protein Superposition

Available in the following product(s): ICM-Browser-Pro | ICM-Pro

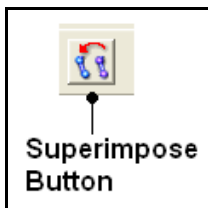

One or more proteins can be superimposed. Simply select the molecules or parts of the molecules you wish to superimpose and then use the selection of protein superimpose tools described in this section. A convenient superimpose button can be found in the `Display` tab (see image of button (left)).

Chapter Contents:

- Select Proteins for Superposition
- Superimpose Button
- Superimpose by 3D
- Superimpose Multiple Proteins
- Arrange as Grid
- Superimpose Sites by Atomic Property Fields

4.4.1 Select Proteins for Superposition

Before any superposition operation can be undertaken you need to select the protein structures you wish to superimpose.

One way to do this is by selecting in the ICM workspace. For other selection tools please see the `Making Selections` section of the manual.

- Select both receptors by double clicking on the name of the molecule in the ICM Workspace. To select two molecules use the `Ctrl` button or use the `shift` button to select a range of objects in the ICM Workspace. A receptor which is selected will be highlighted in blue in the ICM Workspace and with green crosses in the graphical display.

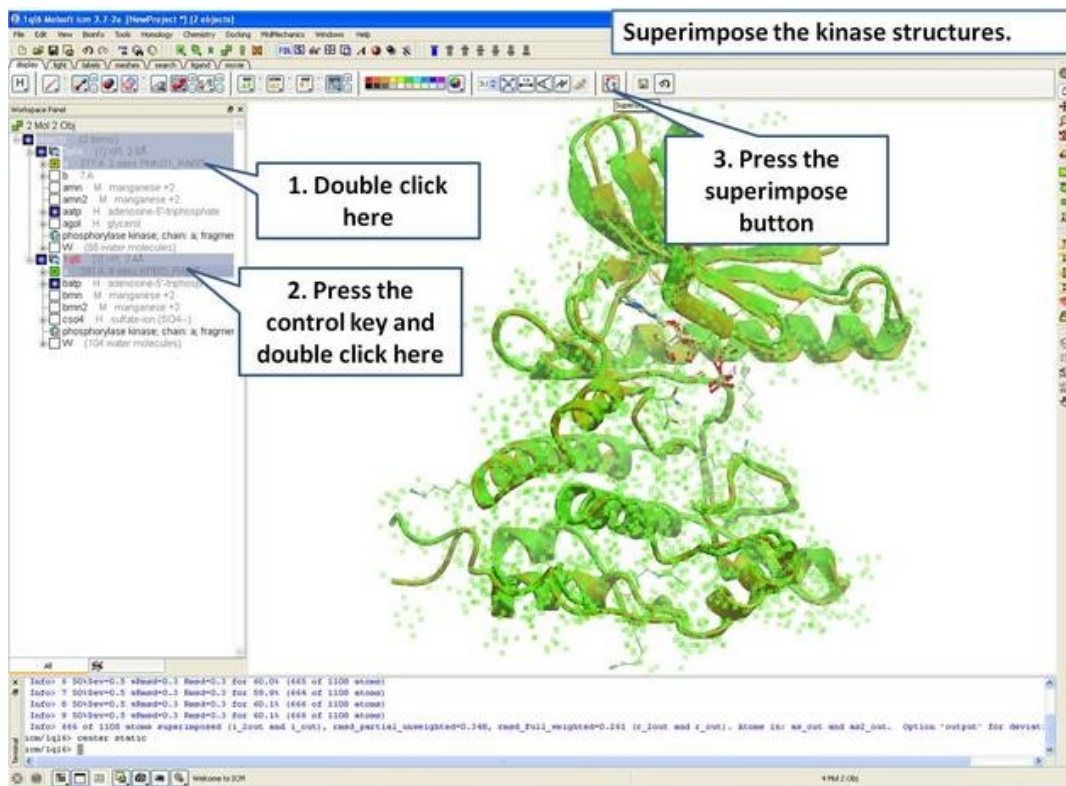

Once the molecules are selected you can then superimpose them using the options described in the next section of this manual.

4.4.2 Superimpose Button

A convenient way to superimpose two molecules is by using the superimpose button in the **display** tab, ICM will calculate the Ca-atom, backbone atom and heavy atom differences between the two structures. More advanced superimpose options can be found in the **Tools/Superimpose** menu.

To superimpose:

- First load the two structures into ICM.
- Select which parts or all of the two structure you wish to superimpose (see the chapter on **Selections** or the description `protein-superposition-select{here}`).
- Select the **display** tab (previously called **Advanced** tab) at the top of the GUI.
- Select the superimpose button.



Superimpose
Button

The rmsd will be displayed in the terminal window as shown below:

```

Info> 64 atoms superimposed, rmsd=1.381643
icm/ly6> superimpose ( Res( as_graph ) & a_./ca,c,n,o ) & Obj( as_graph )[1]
Warning> [110] skipped 4 atom pairs with zero occupancies
Info> 64 atoms superimposed, rmsd=1.381643
icm/ly6>

```

RMSD displayed here

NOTE: You do not need to select the whole molecule, the superimpose button will work on small selections e.g the loop regions or domains.

4.4.3 Superimpose by 3D

To superimpose proteins by 3D:

- First display and select the proteins you wish to superimpose by 3D.
- Tools/Superimpose/Proteins by 3D
- A window as shown below will be displayed.

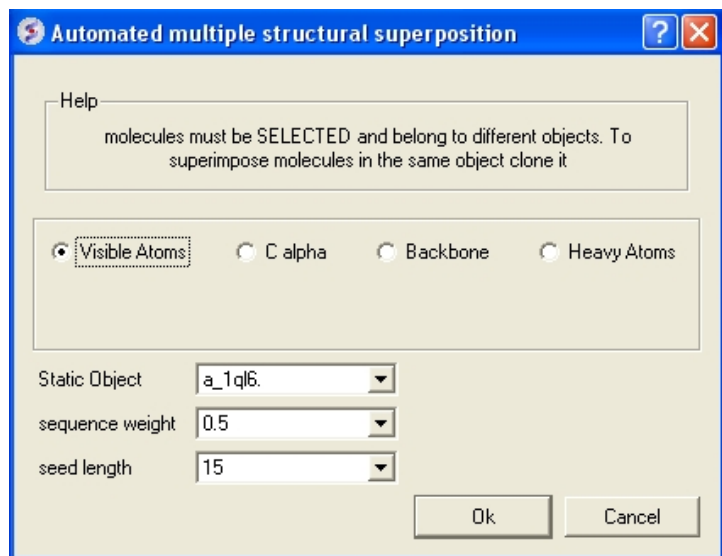

- Select by which atoms you wish to superimpose.
- Enter the ICM selection language description for the protein structure you wish to remain static. You can also use the drop down arrow button to select it.
- Enter the **sequence weight** Average local sequence alignment score.
- Enter the **seed length** This is the similarity window size.

4.4.4 Superimpose Multiple Proteins

To superimpose multiple proteins:

- First display and select the proteins you wish to superimpose by 3D.
- Tools/Superimpose/Multiple Proteins
- A window as shown below will be displayed.

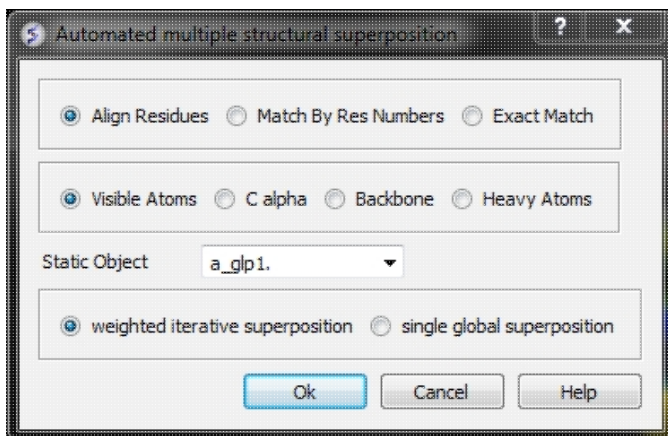

- Select by which method you would like to superimpose

Align Residues - Residue correspondence is established by sequence alignment using the ICM ZEGA alignment Abagyan, Batalov, 1997. Atom alignment: by atom name.

Match by Res Numbers - Residue alignment by residue number. Atom alignment: by atom name for pairs of identical residues or pairs of close residues (F with Y; B with D,N; D with N; E with Q or Z, Q with Z), for other residue pairs only the backbone atoms ca,c,n,o,hn,ha are aligned.

Exact Match - Residue alignment is by the Needleman and Wunsch method. Inside residue atoms are aligned sequentially and regardless of the name.

- Select which atoms you would like to superimpose. Visible Atoms, C alpha, Backbone, or Heavy Atoms.
- Select whether you would like to use **weighted iterative superposition** as described here <http://www.molsoft.com/man/icm-commands.html#superimpose-minimize> or non-iterative **single global superposition**.

4.4.5 Arrange as Grid

To separate superimposed proteins:

- Tools/Superimpose/Arrange as Grid

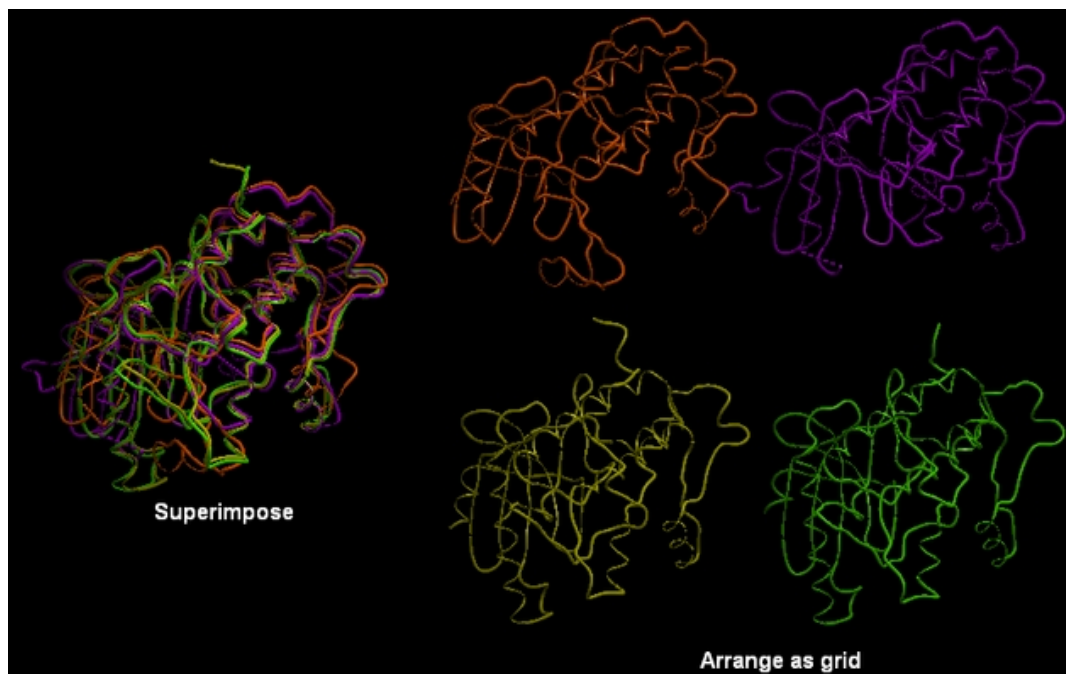

4.4.6 Superimpose Sites by Atomic Property Fields

Here we describe how to superimpose and compare a ligand binding site using Atomic Property Fields. This method is described in more detail in [this publication](#).

In this example we superimpose the ligand binding pocket of thiamine diphosphate in the binding sites of pyruvate dehydrogenase (pdb code: 1rp7) and pyruvate decarboxylase (pdb code: 1pvd). Even though the sequence identity between both proteins is very low (19%) and the secondary structure surrounding the ligand undergoes considerable displacement you will see that the pockets can still be superimposed very well using the APF method.

Some Comments about Selecting the Pocket APF pocket overlay works by superimposing a layer of receptor atoms around the pocket using APF chemical property fields of these atoms "pocket" of course is something that is not uniquely defined and is somewhat subjective. One way to define it is to use the ligand inside, in which case a layer of receptor atoms within a certain cutoff distance from the ligand is considered in superposition. This is "around selected ligand" mode. It focuses on atoms that directly interact with the ligand while largely disregarding backbone fold, which can be helpful when comparing different pockets binding similar ligands. The other mode uses input selections directly, leaving it up to the user to define the sets of atoms that comprise the two pockets. Depending on the system and degree of similarity, different selections may work better or worse. For instance in the absence of ligand one may want to detect pocket with `pocket finder` and then select residues around the pocket "blob". Regarding the influence of ligand on superposition, if pocket is defined via the ligand it will of course matter whether the ligands extend into certain regions or not. If external pocket definition is used, ligands will have no direct effect on superposition process.

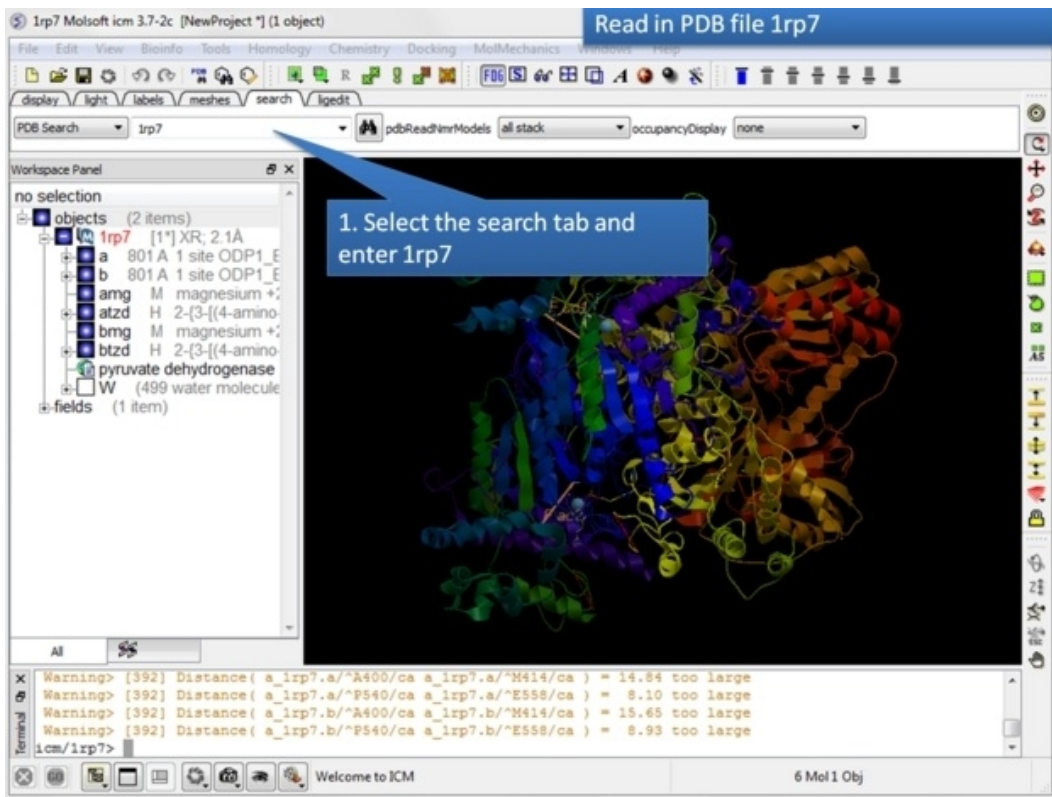

Step 1: Read in the pyruvate dehydrogenase (pdb code: 1rp7) structure.

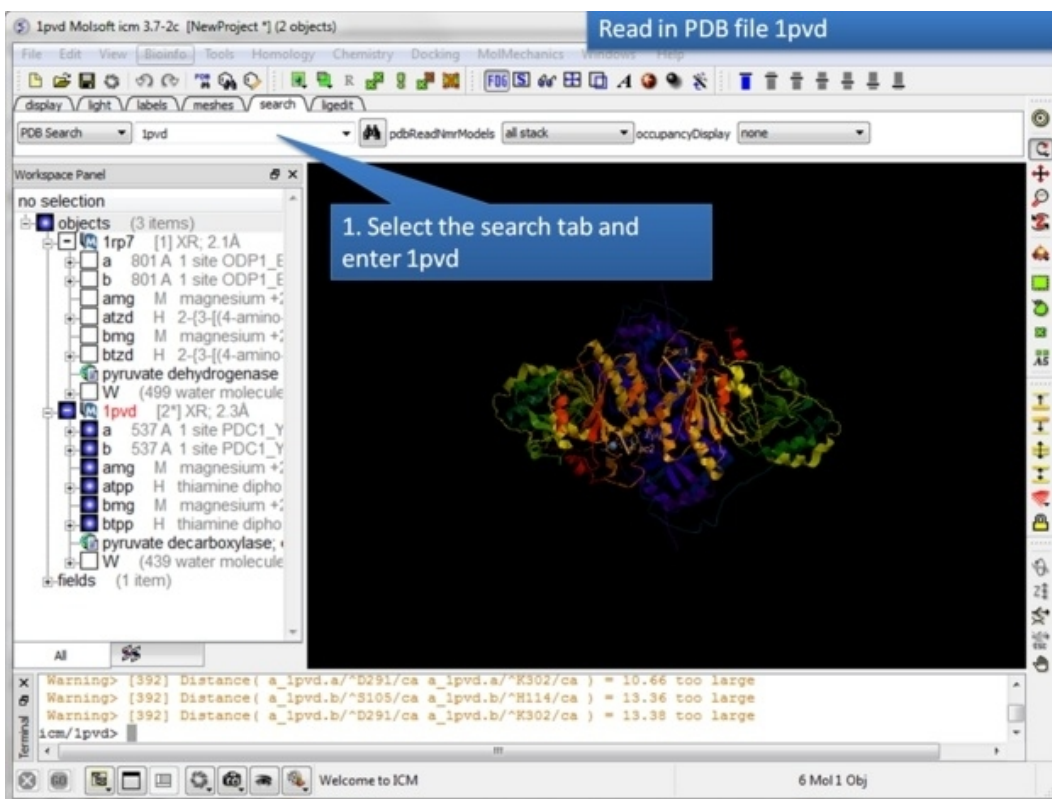

Step 2: Read in the pyruvate decarboxylase (pdb code:1pvd).

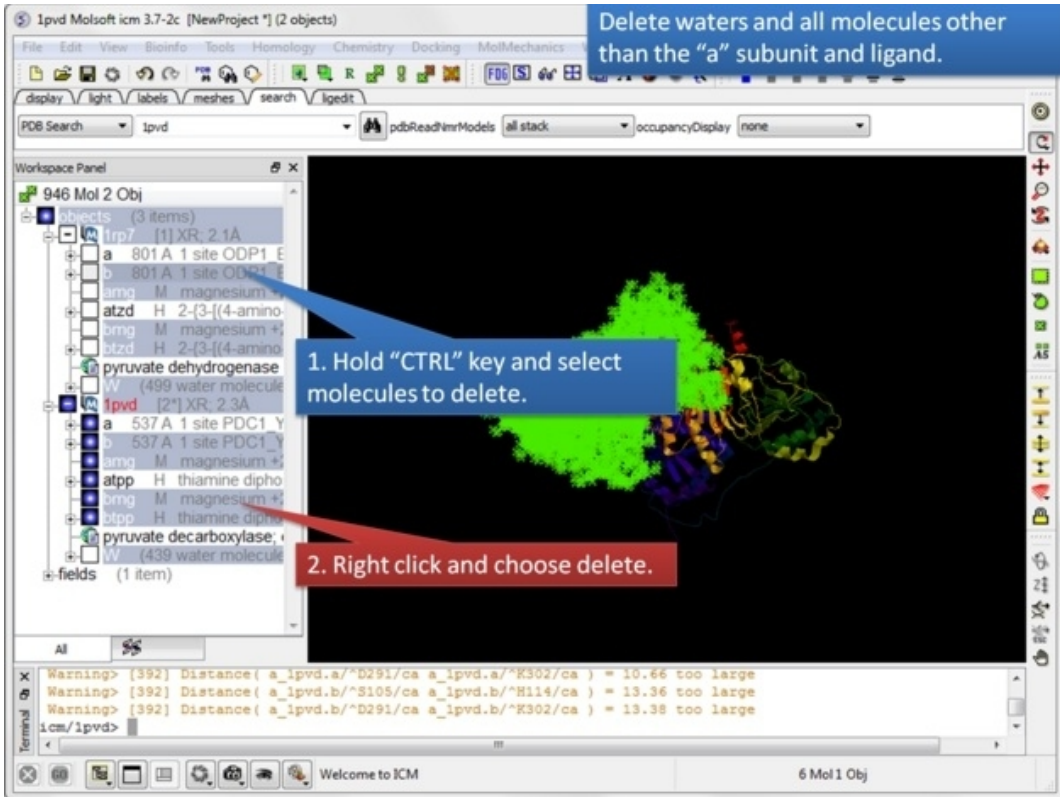

Step 3: Delete unwanted molecules in the b chain and waters.

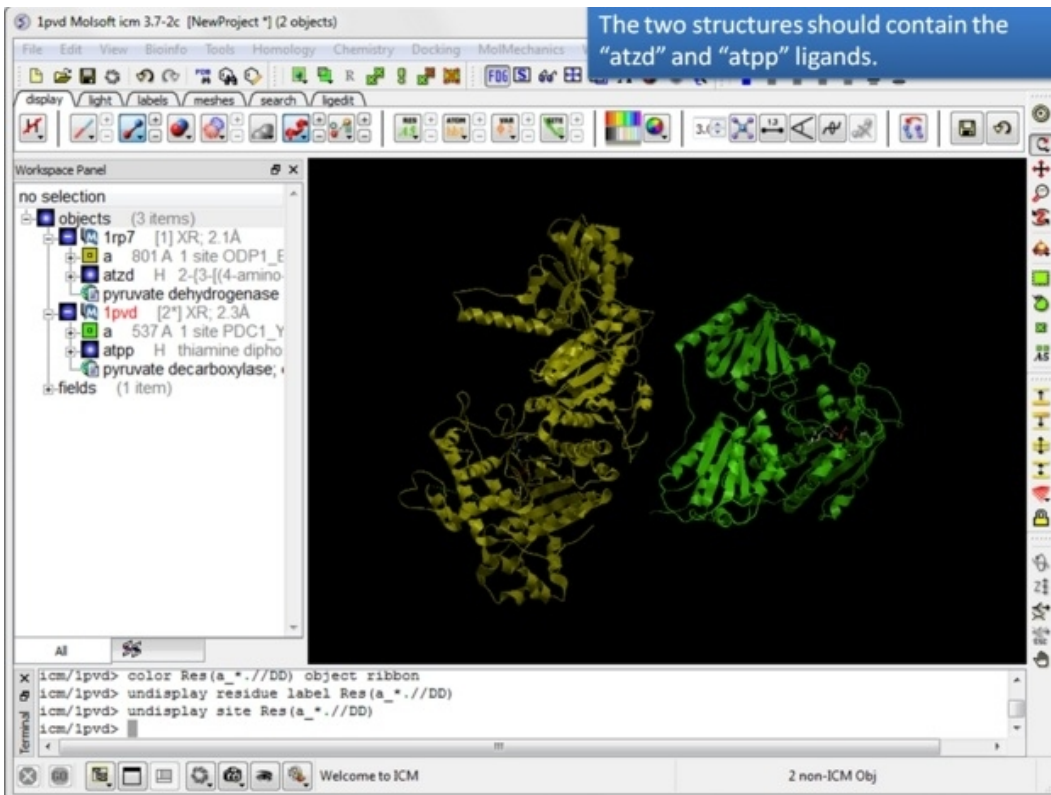

Step 4: You should have two objects containing the protein and ligand.

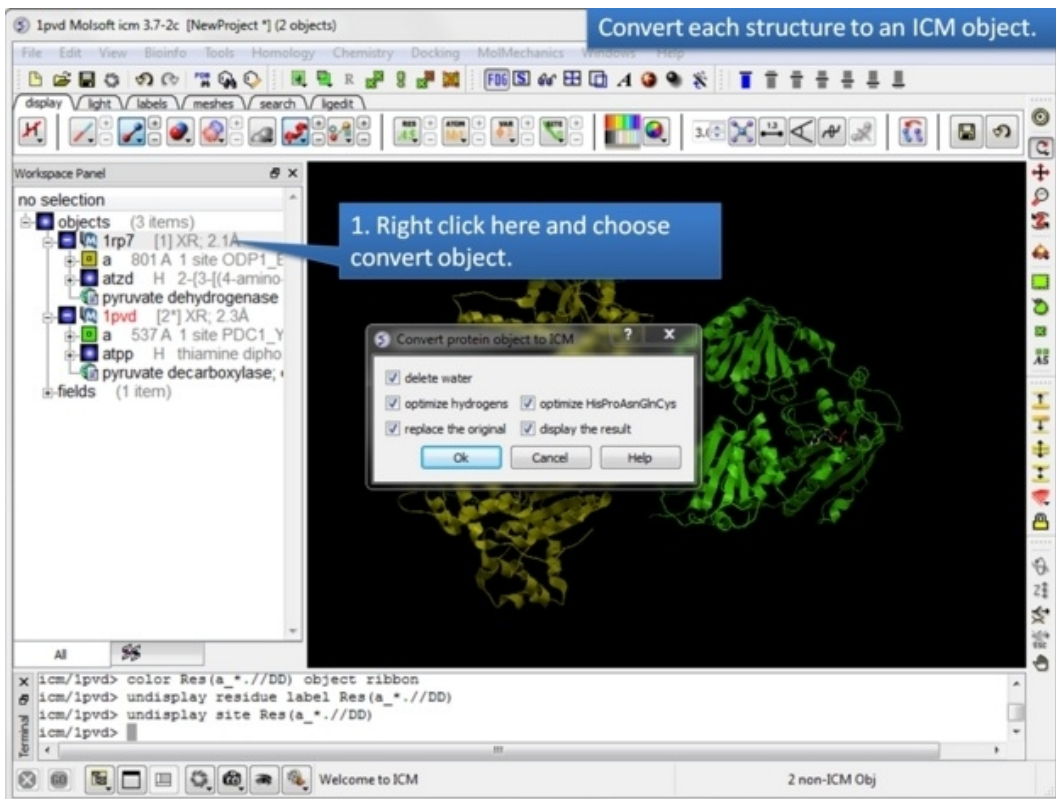

Step 5: Convert both structures to an ICM object.

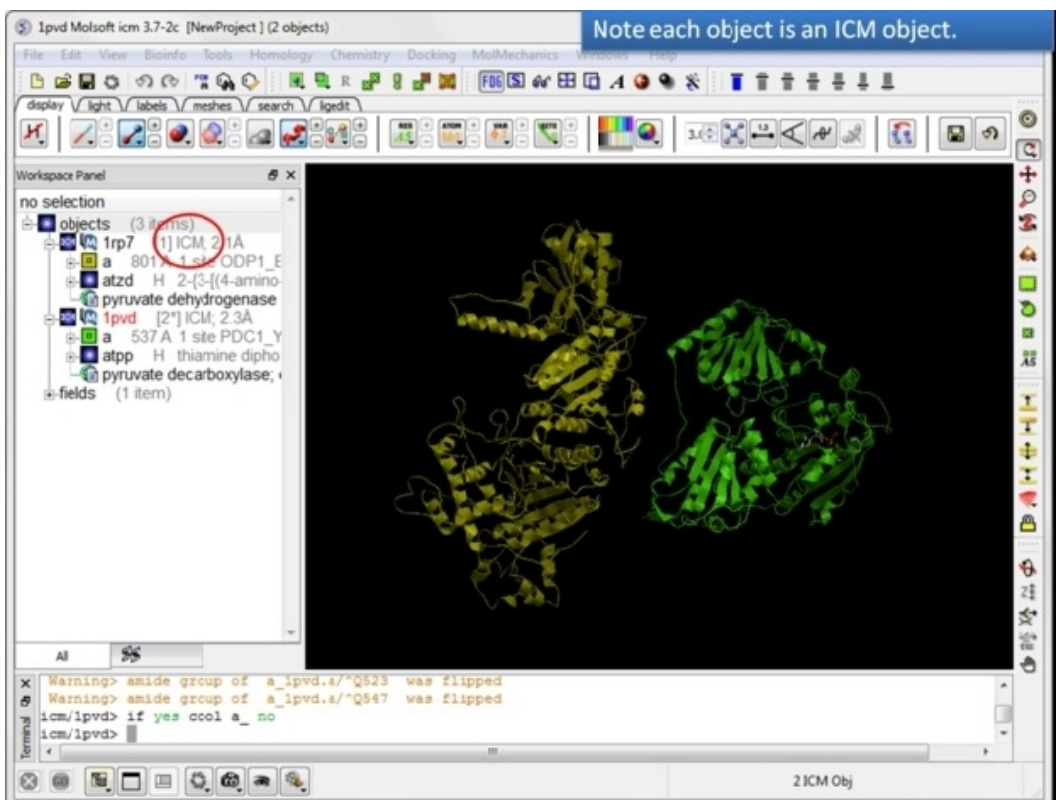

Step 6: If the pdb is converted you will see "ICM" in the workspace.

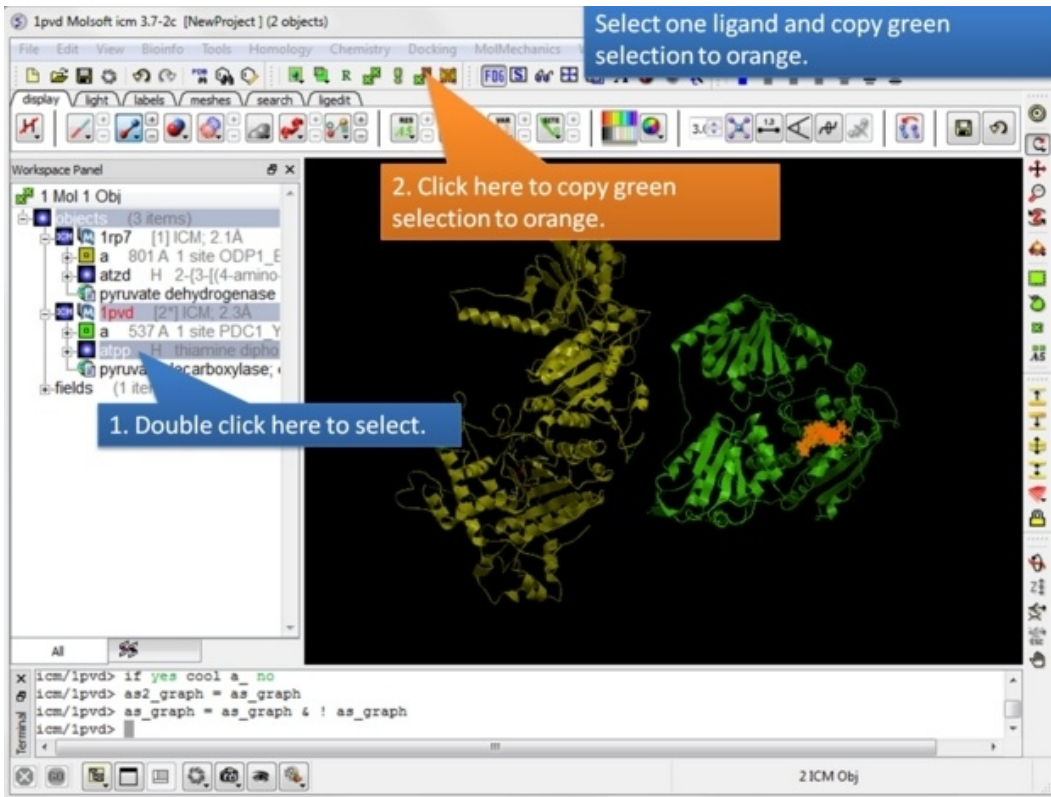

Step 7: Select one ligand and copy the green selection to orange.

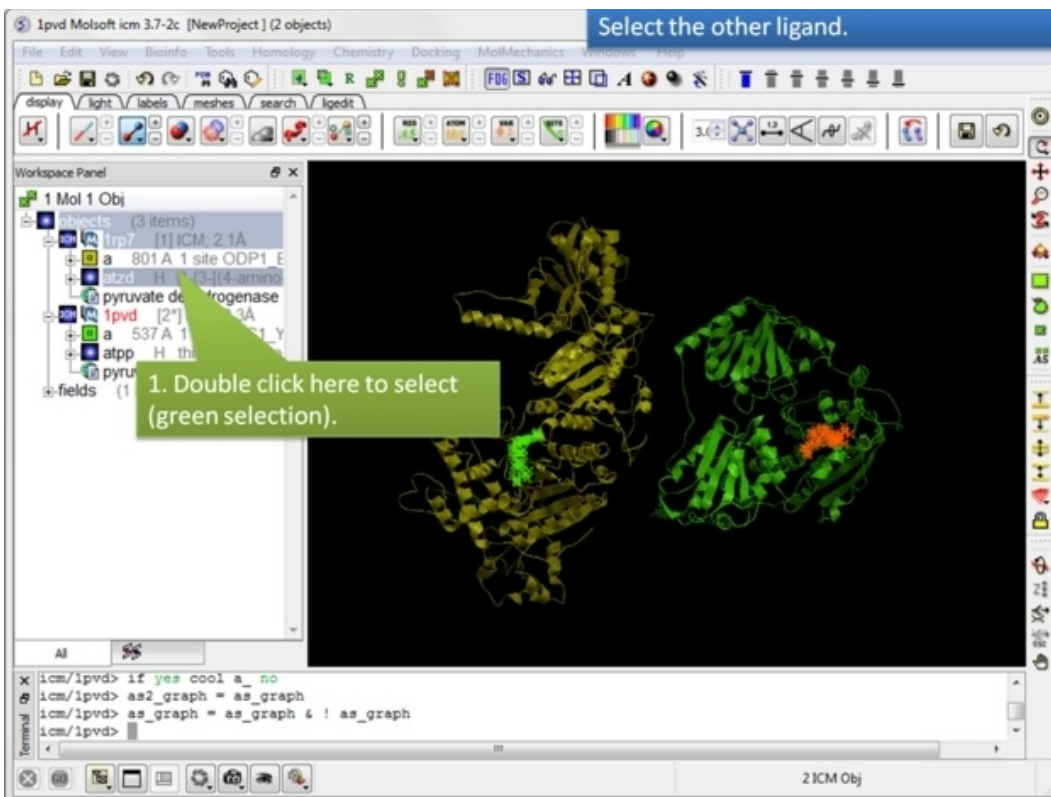

Step 8: Select the other ligand (regular green selection).

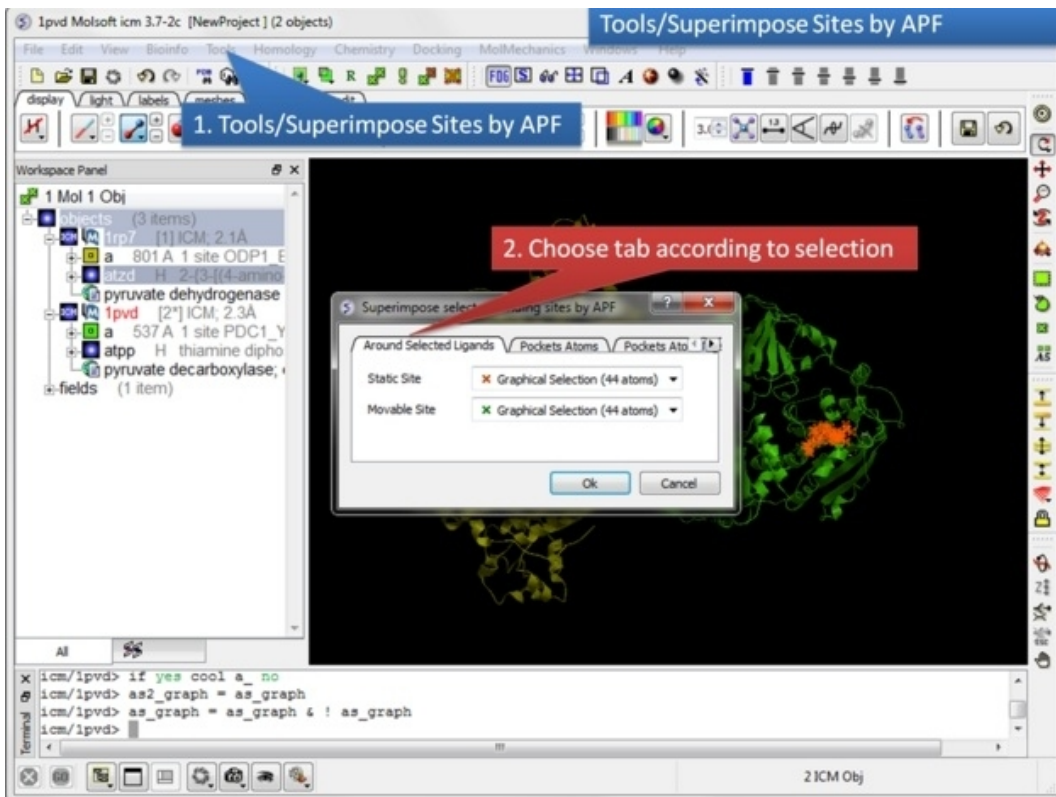

Step 9: Select the option Tools/Superimpose/Sites by APF. Note you can also superimpose pockets - choose the appropriate tabs in the dialog box.

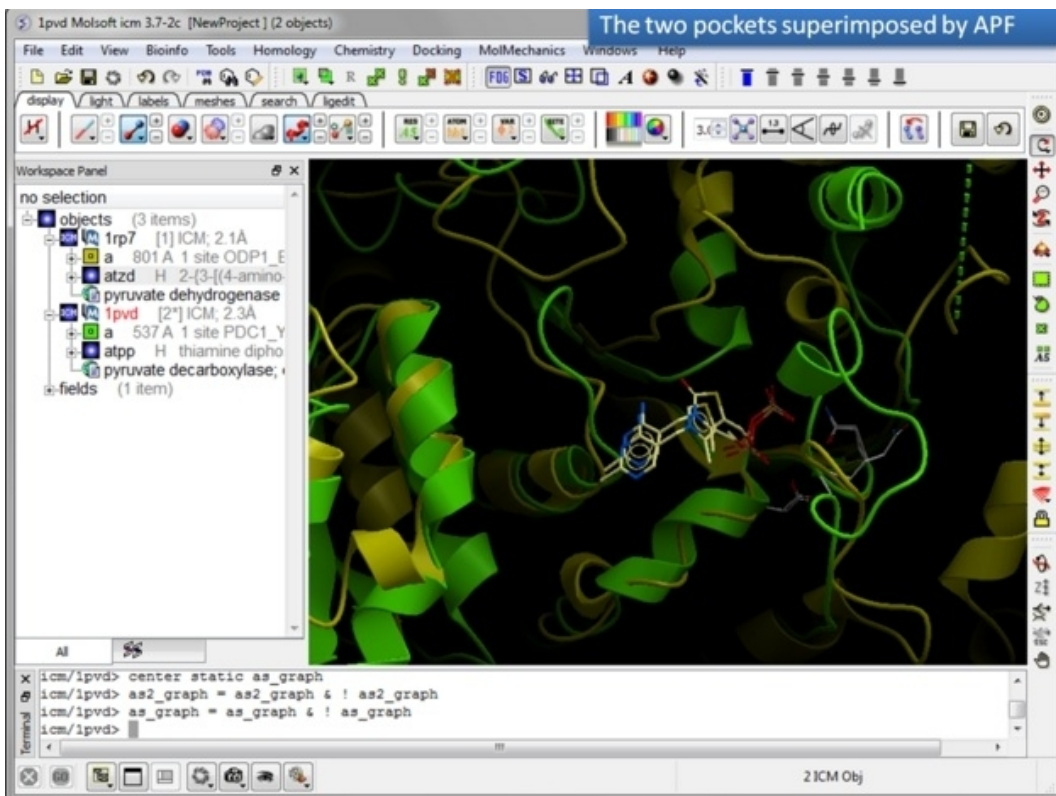

Step 10: Observe the superimposed site.

4.5 Protein Structure Analysis

Available in the following product(s): ICM-Browser-Pro | ICM-Pro

In this chapter we describe the tools available for analyzing protein structure. These tools include calculating RMSD, identifying closed cavities, calculating contact and surface area, measuring angles and distances, and generating Ramachandran plots.

Chapter Contents:

- Find Related Chains
- Calculate RMSD
- Contact Areas
- Identify Closed Cavities
- Surface Area
- Measure Distances
- Planar Angle
- Dihedral Angle
- Ramachandran Plot Interactive
- Export Ramachandran Plot

4.5.1 Find Related Chains

This option allows you to search the currently loaded PDB files or ICM objects and identify chains which are similar and/or related.

You can do this by:

- Select the objects or pdb files you want to compare.
- Tools/Analysis/Find Related Chains
- Click OK to confirm the selection you made
- A table as shown below will be displayed.

	name1	name2	len1	len2	seqid	rmsd	consensus
1	2jc6.a	2jc6.c	278	277	100	0.12	SWKKQAEDIKKIFEFKETLGTGAFSEVLAEEKATGKLFAY IENEIAVLRKIKKHENIVALEDIYESPNHLYVMQLVSGGELF
2	2jc6.a	3bhh.a	278	289	39	0.42	# # # E # G # V L # T G # A # K # I # + # # # E # # # R # K H N I V L D # # # Y L V # L V G G E L F - I V + # Y E D A S # I Q # L - A V # # # # M G # V H R D L K P E N L L # # # # # P G Y # P E V L # Y K # V D # W # G V I # Y I L L # G Y P P F # D E
3	2jc6.a	3bhh.b	278	289	38	0.41	# # # E # G # # # V # T G # A # K # I # + # # # E # #
4	2jc6.a	3bhh.c	278	285	37	0.44	# # # E # # # # E A # K # # + # # # E # # # R # K H
5	2jc6.a	3bhh.d	278	286	37	0.43	# # # E # # # # E A # K # # + # # # E # # # R # K H
6	2jc6.c	3bhh.a	277	289	39	0.44	# # # E # G # V L # T G # A # K # I # K # # E # # # R
7	2jc6.c	3bhh.b	277	289	39	0.43	# # # E # G # # # V # T G # A # K # I # K # # E # #
8	2jc6.c	3bhh.c	277	285	38	0.44	# # # # # V # # T G # A # K # I # K # # E # # # R

name1 = Name of query structure molecule **name2** = Name of hit **len1** = length of query **len2** = length of hit **seqid** = Sequence identity percentage **consensus** = Consensus sequence

4.5.2 Calculate RMSD

NOTE: This option is for protein structures only not for chemical compounds. You can use the command line options RMSD (<http://molsoft.com/man/icm-functions.html#Rmsd>) and Srmsd (<http://molsoft.com/man/icm-functions.html#Srmsd>) for chemicals.

To calculate RMSD between two protein structure:

- Read into ICM the two structures (File/Open or PDB Search or Read in Chemical) you wish to compare.
- Select one of the two molecules you wish to compare, you can do this by double clicking on the name of the structure in the ICM Workspace. Convert this selection to an Orange Selection.
- Select the second molecule, and then you should have one orange and one green selection in the graphics display.

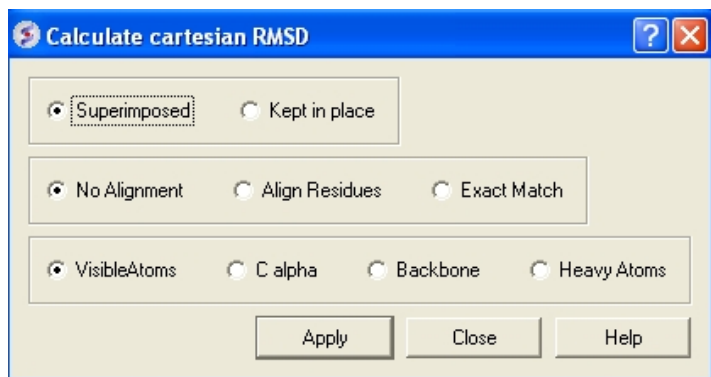

- Select whether you wish the atoms to be superimposed onto one another or kept in place. The kept in place option would be ideal for comparing docked structures.
- Choose whether you wish to make the superposition by alignment or exactly matching the atom names.
- Select which atom types you wish to superimpose.

The **RMSD** value will be displayed in the terminal window.

4.5.3 Contact Areas

- Read in a protein structure (File/Open or PDB Search).
- Select the region you wish to analyse.
- Tools/Analysis/Contact Areas
- The xstick display in the region will be scaled according to the atom/residue contact area. For example, residues making large contacts with a ligand will be displayed in thicker xstick representation (and colored yellow) than those making less significant contacts.
- A table as shown below will be displayed. The table lists the contact area, exposed area, percentage of contact area compared to exposed, the nearest atom of a residue and the distance.

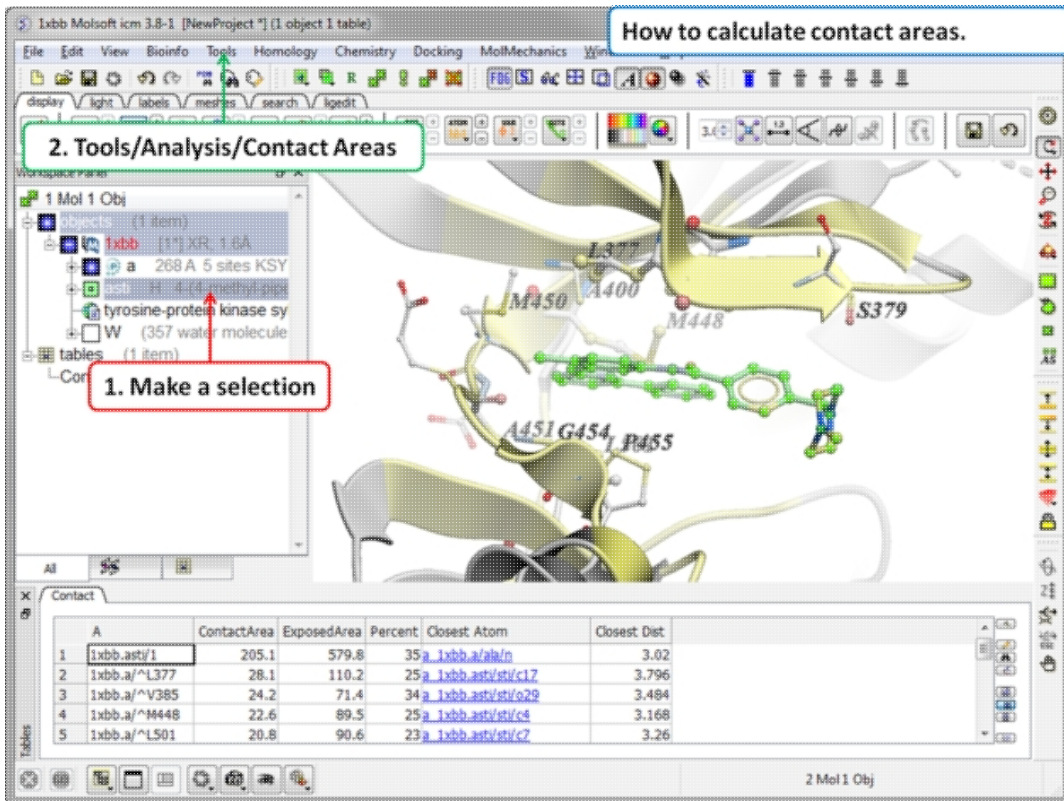

4.5.4 Identify Closed Cavities

This tool will identify cavities within a molecule which are completely closed. If you are looking for buried and open pockets then use `icmPocketFinder`.

- Read in a protein structure (File/Open or PDB Search).
- Convert the protein structure to an ICM object.
- Tools/Analysis/Closed Cavities
- Use the drop down arrow to locate the molecule you are interested in.
- Enter the minimum volume of the cavities you wish to identify.
- Click OK
- The closed cavities will be displayed in the meshes section of the ICM Workspace and a table of the cavities will be displayed. Double click on a row in the table to jump to a particular closed cavity and select the residues surrounding it.

How to predict Closed Cavities.

2. Tools/Analysis/Closed Cavities

1. Right click and choose convert to ICM object

3. Toggle cavity display on/off here

4. Double click here to select the residues surrounding the cavity

i	Volume	Area	Radius	Type
1	72.83	91.92	2.377	cavity2
2	30.11	48.89	1.848	cavity3
3	31.51	49.67	1.902	cavity4
4	23.17	40.27	1.726	cavity5
5	21.22	38.32	1.661	cavity6
6	17.3	32.99	1.573	cavity7

Header Filter Volumes an...

Volumes and areas

Area

Volume

2 Mol 1 Obj

What is the difference between Closed Cavity and ICMPocketFinder?

Closed pocket (cavityFinder) is purely geometrical/topological - it is a part of molecular surface that is completely disconnected from the exterior surface. It means that a probe sphere of 1.4Å radius (representing a water molecule) can not pass in or out of the cavity (considering protein as completely rigid of course). icmPocketFinder identifies pockets that are likely to contain ligands (not specifically open or closed pockets). Pockets are defined based on physical interaction rather than geometric criterion. Blobs of 'pocket density' generated by icmPocketFinder represent continuous regions of space where there is significant favorable van der Waals interaction with the receptor.

4.5.5 Surface Area

This option calculates solvent accessible area of each selection in multiple objects and stores it in a table. If a molecule is specified in a multi-molecular object, the surface area of an isolated molecule is calculated and other molecules are ignored. The area is reported in square Anstroms and the probe radius is assumed to be the value set in the variable waterRadius.

Output: the macro creates table AREA . The empty comment field is added for user's future use. If the table exists, new rows are appended.

To calculate a surface area:

- Read in a protein structure (File/Open or PDB Search).
- Select the region you wish to analyse.
- Tools/Analysis/Surface Area
- A table will be displayed listing the residues in the selection along with the corresponding total surface area.

4.5.6 Measure Distances

There are two approaches to calculating and displaying distances between atoms. You can either use the options in the `Labels` tab or use `Tools/Analysis/Distance`.

To display **all to all** distances:

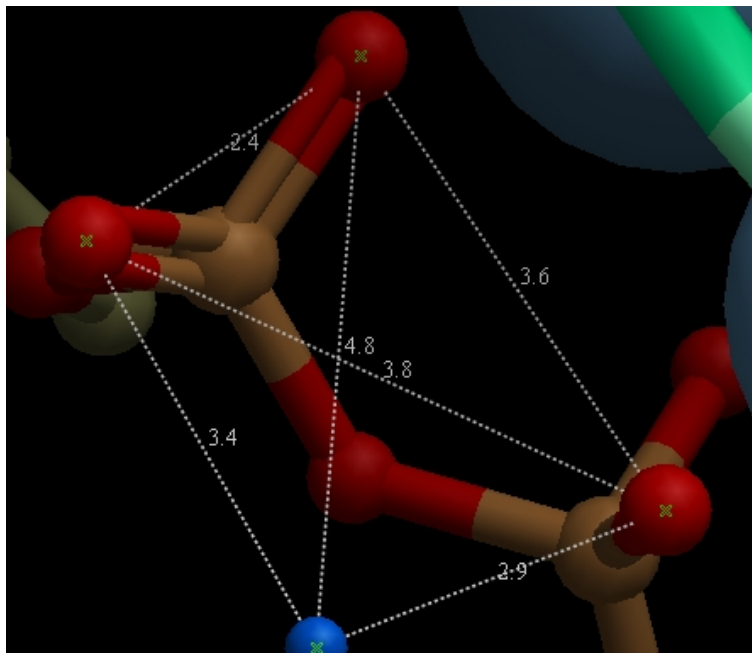

- Select the atoms between which you would like to find the distance. (See `selection toolbar`)
- `Tools/Analysis/Distance`
- Select **all to all**

To display **intermolecular** distances

- Select the atoms between which you would like to find the distance. (See `selection toolbar`)
- `Tools/Analysis/Distance`
- Select **intermolecular**

To display the distances between the same atoms in two objects.

- Select the atoms between which you would like to find the distance. (See `selection toolbar`)
- `Tools/Analysis/Distance`
- Select **same atoms in two objects**

NOTE: Distances can be displayed and undisplayed in the 3D labels section of the ICM Workspace. You can change the color of a distance label by right clicking on it in the ICM Workspace. You can also export the distance to a table.

4.5.7 Planar Angle

If you wish to find the planar angle between three atoms:

- Select **Tools/Analysis/PlanarAngle**

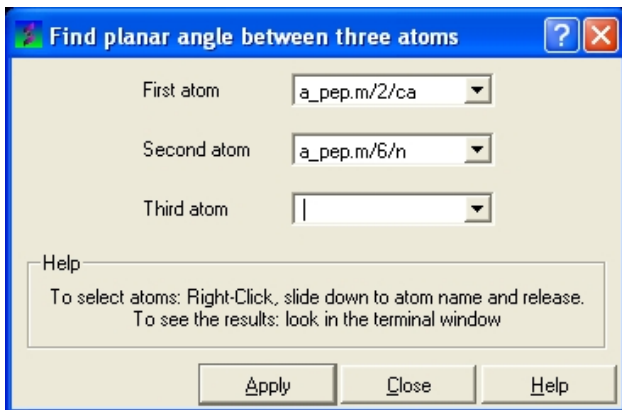

- Right click on each of the three atoms which you wish to use, and select their name. The spaces next to **First atom**, **Second atom**, and **Third atom** should now contain the name of your atoms.

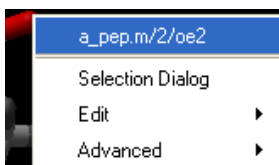

- Click **Apply** to display the angle measure in the terminal window.

angle (a_pep.m/6/hh21 a_pep.m/2/oe2 a_pep.m/3/o) = 74.72 deg.

4.5.8 Dihedral Angle

In order to find the angle dihedral angle between two sets of atoms:

- Select **Tools/Analysis/Dihedral Angles**.

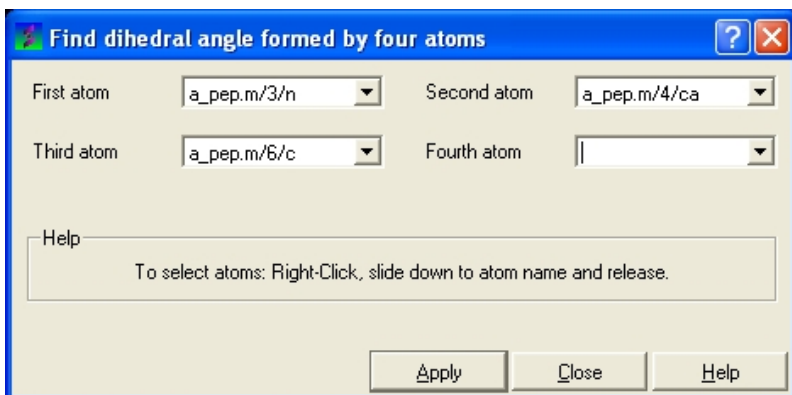

- Right click on each of the four atoms which you wish to use, and select the name of the atoms. The spaces next to **Atom 1**, **Atom 2**, **Atom 3**, and **Atom 4** should now contain the names of your atoms.

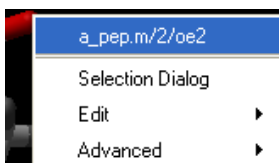

- To find the correct angle, select your atoms according to the following diagram:

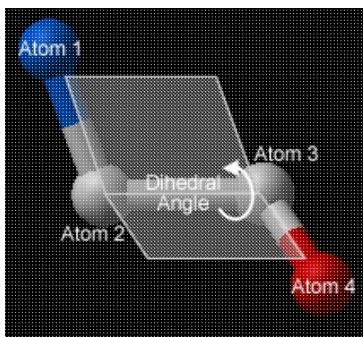

- Click **Apply** to display your dihedral angle measure in the terminal window.

4.5.9 Ramachandran Plot Interactive

To make an interactive ramachandran plot:

- Read in a protein structure (**File/Open** or **PDB Search**).
- Select the structure you wish to build the plot for. You can do this by double clicking on the name of the structure in the ICM Workspace (a selection is highlighted blue in the ICM Workspace and green crosses in the graphical display) or you can use the right-click button and drag it over the whole structure in the graphical display.
- **Tools/Analysis/Ramachandran Plot Interactive**
- The interactive ramachandran plot will be displayed in table called **RAMA**.
- You can view the **Omega**, **Phi/Psi** (Gly) or **Phi/Psi** angles by clicking on the tabs at the top of the plot. Each point is linked to the data in the table **RAMA** and also to the graphical display. Clicking on a point in the plot will highlight the corresponding angles in the table and also center on this region in the 3D display.

4.5.10 Export Ramachandran Plot

- Read in a protein structure (**File/Open** or **PDB Search**).
- Select the structure you wish to build the plot for. You can do this by double clicking on the name of the structure in the ICM Workspace (a selection is highlighted blue in the ICM Workspace and green crosses in the graphical display) or you can use the right-click button and drag it over the whole structure in the graphical display.
- **Tools/Analysis/Ramachandran Plot Export**

A postscript viewer needs to be downloaded onto your machine in order to view the plot. This can be downloaded from <http://www.cs.wisc.edu/~ghost/>. Once this software is downloaded you need to tell ICM where it is located by typing the pathname into **File/Preferences**.

NOTE: You can always export the plot as an image directly in ICM without exporting. You can do this by right clicking on the plot and select **save as image**. Another approach could be to export the RAMA table to Excel and use the plotting tools there. You can do this by right clicking on the table name tab and selecting "Export to Excel" or save as ".csv".

4.5.11 Protein Health

Theory

The protein health option calculates the energy strain of a structure in ICM. It is generally a good idea to investigate the energy strain of any protein structure before undertaking such processes as docking. It is also essential to use this tool after making a model (see Molecular Modeling) to identify strained regions within your model and then some optimization procedure can be undertaken to rectify the problems.

The protein health option calculates the relative energy of each residue for a selection and colors the selected residues by strain. This macro uses statistics obtained in the following paper Maierov, V.N. and Abagyan, R.A. (1998) Energy strain in three-dimensional protein structures *Folding and Design*, 3 , 259-269.

To use the Protein Health option:

- Read in a protein structure (File/Open or PDB Search).
- Convert your PDB structure into an ICM object.
- Make a selection of the residues you wish to analyze.
- Tools/3D Predict/Protein Health and a window as shown below will be displayed.
- The scale of the coloring can be changed by altering the value within the trimEnergy data entry box.
- Click OK and the structure will be colored according to energy strain (red - high) and a table of residue energy will be displayed in a table.
- A table and plot of Normalized energies for each amino acid in the selection will be displayed. The table is ranked and colored by residues with poor normalized energies. Click on a row in the table or plot to center in on the residue.

4.5.12 Local Flexibility

This option systematically samples rotamers for each residue side-chain in the input selection and uses resulting conformational ensembles to evaluate energy-weighted RMSDs for every side-chain atom. These are stored in the 'field' values on atoms and can be used for example to color the structure by side-chain flexibility. Conformational entropy for each residue side-chain is also calculated and stored in a table. If `_entropyBfactor` flag is on, the atom rmsds are normalized within the residue to reflect its total conformational entropy. If `_bfactor` flag is set, the bfactors are reset to the same values that are placed in the atom 'field', and occupancy is set to be inversely proportional to it ($O=1/(1+2*rmsd)$)

- Read pdb file (File/Open or PDB Search Tab).
- Convert to an ICM Object.
- Tools/3D Predict/Local Flexibility

4.5.13 Protein-Protein Interface Prediction

The ICM Optimal Docking Area method is a useful way of predicting likely protein-protein interaction interfaces. If you do not have mutational data or other experimental data which indicates the likely protein-protein docking site this method will be useful. This procedure can save you time during the docking procedure by focusing your docking only on areas on the receptor and ligand most likely to interact.

Theory

ODA (Optimal Docking Areas) is a new method to predict protein-protein interaction sites on protein surfaces. It identifies optimal surface patches with the lowest docking desolvation energy values as calculated by atomic solvation parameters (ASP) derived from octanol/water transfer experiments and adjusted for protein-protein docking. The predictor has been benchmarked on 66 non-homologous unbound structures, and the identified interactions points (top 10 ODA hot-spots) are correctly located in 70% of the cases (80% if we disregard NMR structures). For a description of the method see Fernandez-Recio et al *Proteins* (2005) 127: 9632.

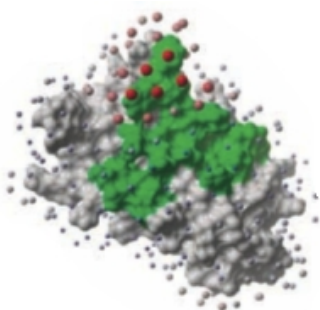

To display the optimal docking area.

- Convert the PDB file to an ICM object.
- Tools/3D Predict/Protein Interface by ODA
- If you select the **Residue Table** option the average ODA score for each residue will be displayed in a table. The lower the number the higher the chance the residue will be involved in protein-protein interactions. Regions colored red represent low ODA score and blue represents a high score.

4.5.14 Identify Ligand Binding Pockets

Theory

The ICM Pocket Finder method (1-2) uses only the protein structure for the prediction of cavities and clefts. No prior knowledge of the substrate is required. The position and size of the ligand-binding pocket are determined based on a transformation of the Lennard-Jones potential by convolution with a Gaussian kernel of a certain size, a grid map of a binding potential and construction of equipotential surfaces along the maps. The pockets are displayed graphically as a surface and the dimensions of each pocket are presented in an interactive table and plot.

Factors that can influence ligand binding to a pocket include the pocket volume and area, buriedness, hydrophobicity, and how compact the pocket is. All these properties are calculated using ICMPocketFinder and tabulated. Scientists at Merck used MolSoft's ICMPocketFinder algorithm to define a way for quantifying "drugability" of a protein target (3). The metric they used is called Drug-Like-Density (DLID), and this score is also provided in the results table. A good example of the use of the icmPocketFinder method is in the database called Pocketome. The Pocketome (www.pocketome.org) is an encyclopedia of conformational ensembles of all druggable binding sites that can be identified experimentally from co-crystal structures in the Protein Data Bank (4).

1. An, J., Totrov, M. & Abagyan, R. Pocketome via comprehensive identification and classification of ligand binding envelopes. *Mol. Cell. Proteomics* 4, 752 (2005).
2. Abagyan, R. & Kufareva, I. The flexible pocketome engine for structural chemogenomics. *Methods Mol. Biol.* Clifton NJ 575, 249-279

(2009).

3. Sheridan, R. P., Maiorov, V. N., Holloway, M. K., Cornell, W. D. & Gao, Y.-D. Drug-like density: a method of quantifying the bindability of a protein target based on a very large set of pockets and drug-like ligands from the Protein Data Bank. *J. Chem. Inf. Model.* 50, 2029.2040 (2010).

4. Kufareva, I., Ilatovskiy, A. V. & Abagyan, R. Pocketome: an encyclopedia of small-molecule binding sites in 4D. *Nucleic Acids Res.* 40, D535.540 (2012).

To predict pockets:

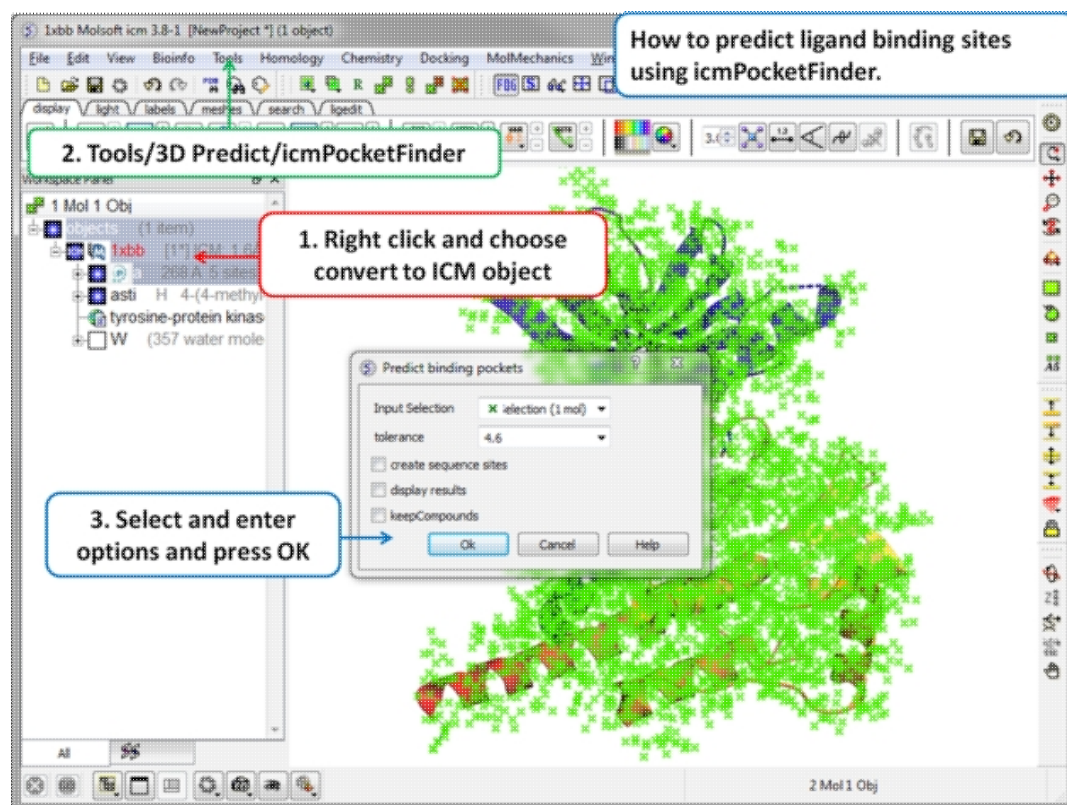

- Read in a protein structure (File/Open or PDB Search).
- Convert the protein structure to an ICM object.
- Tools/3D Predict/icmPocketFinder
- Enter a tolerance level (4.6 is the default value and we recommended you to use this). The lower the tolerance value the more pockets predicted and the higher the tolerance the less pockets predicted.
- Check the box **create sequence sites** if you wish the site to be labeled.
- Check the box **display results** to see the predicted pockets as grobs in the display panel.
- Check the box **keep compounds** if you wish the compounds (ligands) in the receptor to be included in the prediction. If you dont check this box the pockets will be calculated based on the receptor without ligands.
- Click OK to run icmPocketFinder and the results will be displayed in a table.

Results

- Click on a row of the results table to select the residues surrounding the pocket.
- The pocket view can be toggled on or off in the meshes section of the ICM Workspace. Right click on the name of the mesh in the ICM workspace to change properties such as color.
- A fully interactive plot (Area vs Volume) is also provided, pockets that fall within the blue shaded region have a "drug-like" volume and size.

About the icmPocketFinder Results Table

Factors that can influence ligand binding to a pocket include the pocket volume and area, buriedness, hydrophobicity, and how compact the pocket is. These values are reported in the results table:

- **Volume** of the pocket in \AA^3 .
- **Area** of the pocket in \AA^2 .
- **Hydrophobicity** - represents the percentage of the pocket surface in contact with hydrophobic protein residues (values can range from 0-1)
- **Buriedness** - The buriedness parameter is calculated as follows: One measures the solvent accessible surface area of the pocket (probe radius, 1.4) in isolation. Then one measures the solvent accessible surface area of the pocket covered by its shell. The ratio of the second number to the first is the fraction buried. The lowest possible value is 0.5; i.e. the pocket is completely open and the surface flat. The highest is 1.0, i.e., completely buried.
- **DLID** - Merck's Drug-like density score (see Sheridan et al JCI 2010). >0.5 is considered "druggable".
- **Radius** gives an indication of how spherical a pocket is. $(\frac{3}{4} \text{Volume} / \text{Pi})^{1/3}$, i.e. radius of an ideal spherical cavity of the same volume as a pocket blob.
- **Nonsphericity** give an indication of how spherical the pocket is. $\text{Area} / (\text{area of ideal spherical cavity})$. It is 1.0 if the cavity is spherical

- **Conservation** Average conservation (%identity) of residues in contact with the pocket. Calculation is performed if multiple alignment is present and linked to the protein chain being analyzed.
- **RelCons** Above conservation, relative to the average over the entire chain.
- **Type** - returns the ICM selection for the residues forming the pocket.

5 Molecular Graphics

In this chapter we describe how to make beautiful graphical representations of molecules and manipulate them in the 3D graphics window. This includes how to change color, light, representations, clipping planes, and how to use built in graphics effects. We also teach how to label and annotate molecules displayed in the graphical user interface.

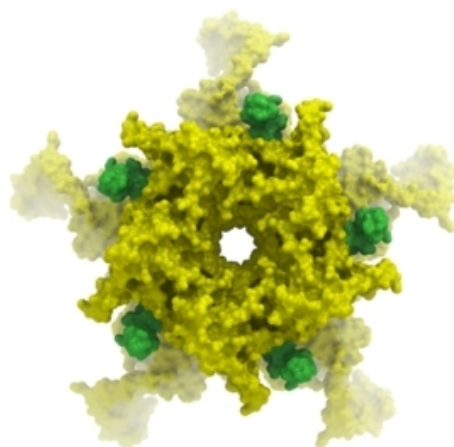

Chapter Contents:

- Molecule Representation
- Meshes-Surface-Grobs
- Coloring
- Lighting
- Labeling and Annotation
- Display Distances and Angles
- Graphics Effects
- Graphics Shortcuts
- Molecule Move Buttons
- Clipping Tools
- Graphic Layers
- High Quality Publication Images
- Movies

5.1 Molecule Representation

Available in the following product(s): ICM-Browser | ICM-Browser-Pro
| ICM-Pro

To change the molecule display representation:

- Select the atoms, residues, molecules, or objects you wish to change in the graphical display or in the ICM Workspace.
- Then use the molecule representation (e.g. wire, ribbon) options in the **Display** Tab.

The display tab contains tools for a variety of functions including - structural representations, coloring, labeling and superposition.

There are six main types of structural representation in ICM. They are wire, ball and stick (Xstick), ribbon, skin, CPK and dot envelope (surface).

To display one of these representations:

- Click on the representation button you desire in the **display** tab.

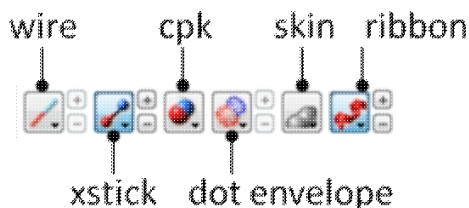

To remove a displayed representation or to toggle between display and undisplay:

- Click on the corresponding representation button in the **display** tab.

Identify which representations are displayed: The button display will change appearance (shaded blue) when selected. This makes it easier to identify which representations are currently being displayed.



Change the display and size of the representations Many characteristics of the graphical representation such as color can be changed by clicking and **holding** on the button. The size can be changed by clicking the plus(+) and minus(-) buttons next to them.

click and hold for more options



5.1.1 Wire Representation

Click and hold on the **wire representation** button. A menu will be displayed as shown below.

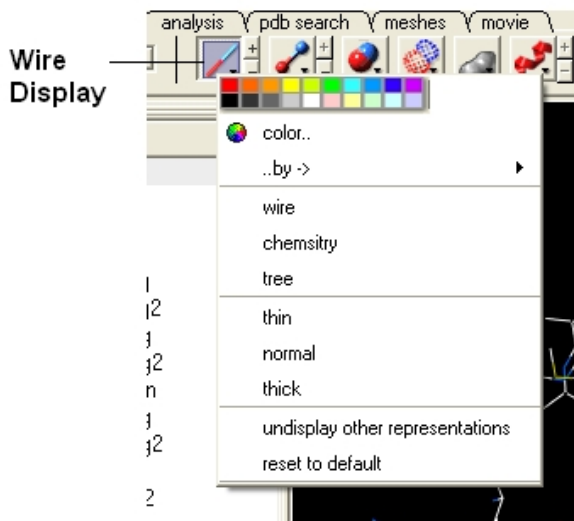

To change the wire style:

- Click and hold on the **wire representation** button and then click on **wire, chemistry** or **tree**.

To change the size of the wire representation:

- Click and hold on the **wire representation** button and then click on **thin, normal** or **thick**.

NOTE: Clicking on the +/- next to the **wire representation** button also changes the thickness of the wire representation.

To undisplay representations other than wire:

- Click and hold on the **wire representation** button and then click on undisplay other representations.

If you make a mistake or you are not happy with the way your structure is displayed with the wire representation:

- Click and hold on the **wire representation** button and then click on reset to default.

5.1.2 Stick and Ball (Xstick) Representation

Click and hold on the **stick and ball representation** button. A menu will be displayed as shown below.

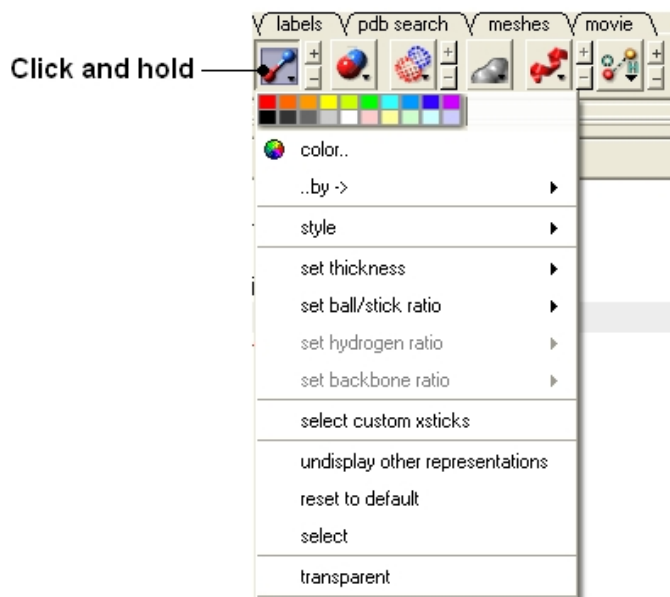

To change the style of the Xstick representation:

- Click and hold on the **stick and ball representation** button and then click on **style** and choose either **plain**, **chemistry**, **Chem Plus**, or **Chem Plus Aromatic**.

To change the size of the Xstick representation:

- Click and hold on the **stick and ball representation** button and then click on **set thickness**, **set ball/stick ratio**, **set hydrogen ratio**, and **set backbone ratio**.

NOTE: Clicking on the +/- next to the **xstick representation** button also changes the thickness of the xstick representation.

In order to make some parts of your picture clearer, the xstick representation can be set to transparent:

- Click and hold on the **stick and ball representation** button and then click on **transparent**.

To undisplay representations other than xstick:

- Click and hold on the **stick and ball representation** button and then click on **undisplay other representations**.

If you make a mistake or you are not happy with the way your structure is displayed with the xstick representation:

- Click and hold on the **stick and ball representation** button and then click on **reset to default**.

5.1.3 Ribbon Representation

Click and hold on the ribbon representation button and a menu will be displayed.

To change the style of the Ribbon representation:

- Click and hold on the **ribbon representation** button and then click on a style option: **smooth**, **wide**, **wide smooth**, **cylinders**, **protein worm**.

To assign secondary structure:

To accurately represent the secondary structure of the molecule in ribbon representation you may wish to assign secondary structure:

- Click and hold on the **ribbon representation** button and then click on **assign sec. structure**.

To make some parts of your picture clearer, the ribbon representation can be set to transparent:

- Click and hold on the **ribbon representation button** and then click on **transparent**.

To undisplay representations other than ribbon:

- Click and hold on the **ribbon representation** button and then click on undisplay other representations.

If you make a mistake or you are not happy with the way your structure is displayed with the ribbon representation:

- Click and hold on the **ribbon representation button** and then click on **reset to default**.

NOTE: Always use the **ICM assign sec.**** structure tool in the ribbon right click menu to get accurate secondary structure assignment. This is particularly important when studying helices which may have non-cannonical elements within them such as 3/10 or pi. To view non-cannonical helix segments use the segment option in the ribbon right click menu.

To change the display of chain breaks (dotted lines):

- Click and hold on the ribbon representation button.
- Select the options Display Chain Breaks or Display Chain Break label.

5.1.4 Skin Representation

Click and hold on the **skin representation button**. A menu will be displayed as shown below.

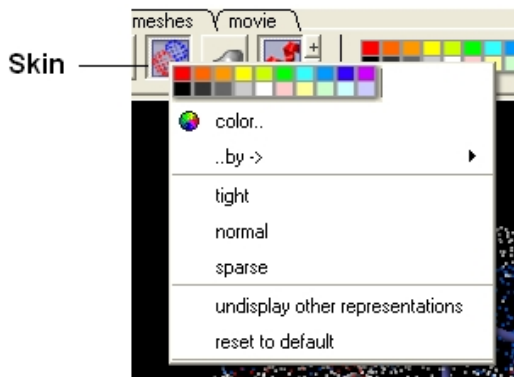

To make some parts of your picture clearer, the skin representation can be set to tight, normal or sparse:

- Click and hold on the **skin representation button** and then click on either tight, normal or sparse.

To undisplay representations other than skin:

- Click and hold on the **skin representation button** and then click on **undisplay other representations**.

If you make a mistake or you are not happy with the way your structure is displayed with the skin representation:

- Click and hold on the **skin representation button** and then click on **** reset to default****.

NOTE: Sometimes due to singularity problems holes may appear within the skin surface. To cure this inflexion select atoms nearby and right click select Advanced->RandomizeAtoms

5.1.5 CPK Representation

Click and hold on the **CPK representation button**. A menu will be displayed as shown below.



To undisplay representations other than CPK:

- Click and hold on the **CPK representation button** and then click on **undisplay other representations**.

If you make a mistake or you are not happy with the way your structure is displayed with the cpk representation.

- Click and hold on the **CPK representation button** and then click on **reset to default**.

5.1.6 Surface Representation

Click and hold on the **surface representation button**. A menu will be displayed as shown below.

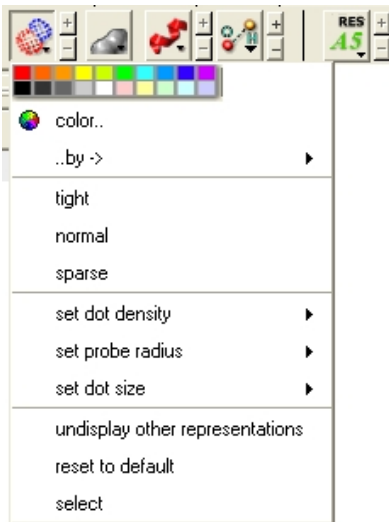

To change the style of the surface representation:

- Click and hold on the **surface representation button** and then click on **tight**, **normal**, or **surface**.

To undisplay representations other than surface:

- Click and hold on the **surface representation button** and then click on undisplay other representations.

If you make a mistake or you are not happy with the way your structure is displayed with the surface representation:

- Click and hold on the **surface representation button** and then click on **reset to default**.

5.1.7 Display and Undisplay Hydrogens

To display and undisplay hydrogens. Click and hold on the "**Change Hydrogen Display**" button shown below. Multiple single clicks will toggle through the hydrogen display options.

- Display Tab
- Click and hold on the "**Change Hydrogen Display**" button shown below.

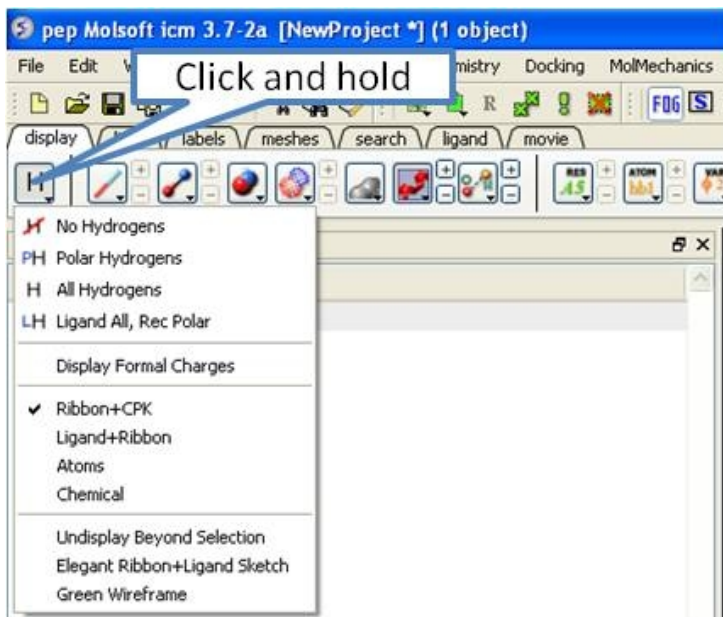

5.1.8 Display Hydrogen Bond

NOTE: The method by which hydrogen bonds are calculated is described here in the command line manual. The GRAPHICS.hbondMinStrength parameter determines the hbond strength threshold for hbond display. The strength value is between 0. and 2. By changing 1. to 0.2 you will see more weak hydrogen bonds.

In order to display potential hydrogen bonds in your structure:

- Convert to an ICM Object
- Make a selection - if you are trying to display the H-bonds between a ligand and the receptor make sure the ligand is part of the selection.
- Click the Display Tab.
- Click on the **Toggle H-bonds** icon in the **display** tab.

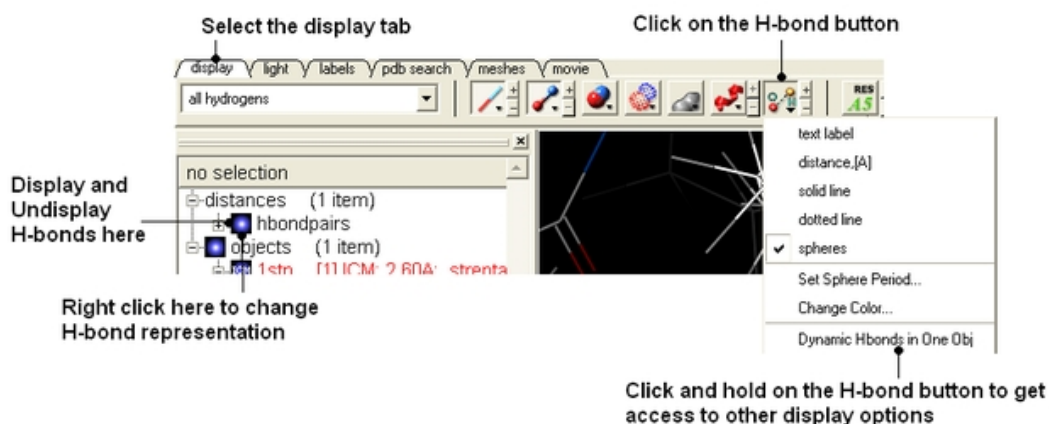

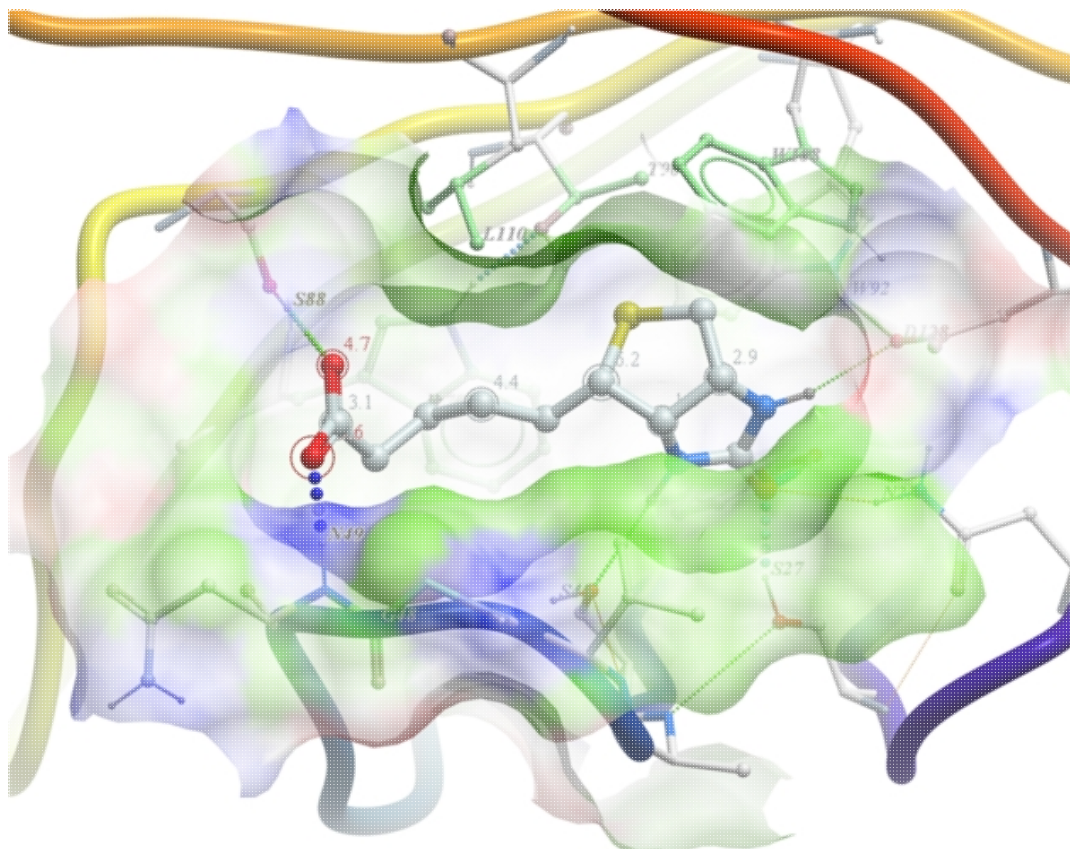

- Click the +/- on the right of the H-Bond button to change thickness of H-bond representation.
- Click and hold the button to change representation or use the **hbondpairs** option in the ICM Workspace.

Click and hold

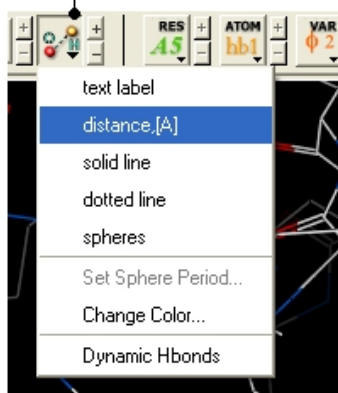

What do the default coloring of the H-bond represent?

Longer and shorter H-X distances in the hydrogen bond are color-coded, from red to blue, respectively.

NOTE Dynamic hydrogen bonds can be set by clicking and holding on the **H-bond toggle** button in the **Display** tab. Hydrogen bonds will then respond to any changes made to the ligand.

5.1.9 Display Formal Charges

You can display formal charges by clicking and holding on the "Change Hydrogen Display" button in the **Display** tab.

5.1.10 Ca (carbon alpha) Trace

To generate a carbon alpha (Ca) trace:

- Right click on the object in the ICM workspace and select Tools/Make Ca-Trace object.
- The Ca-Trace object will be displayed in the ICM workspace.

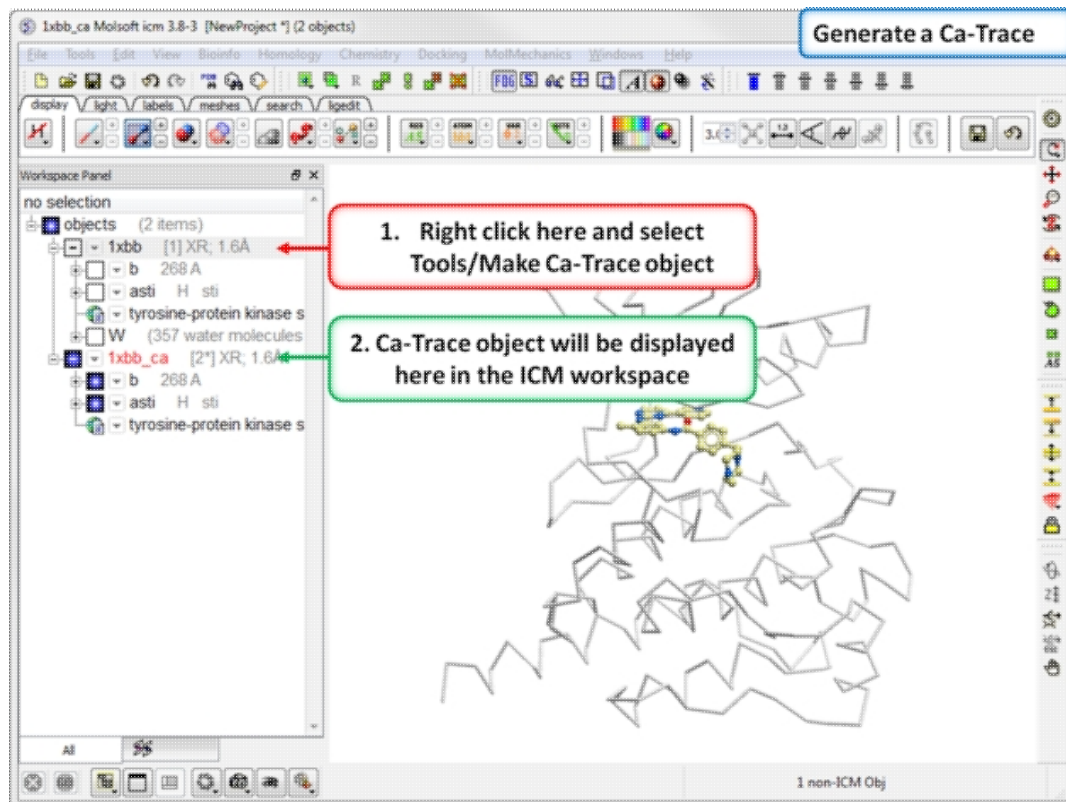

5.2 Multi-Windows

To display more than one window click on the buttons shown below.

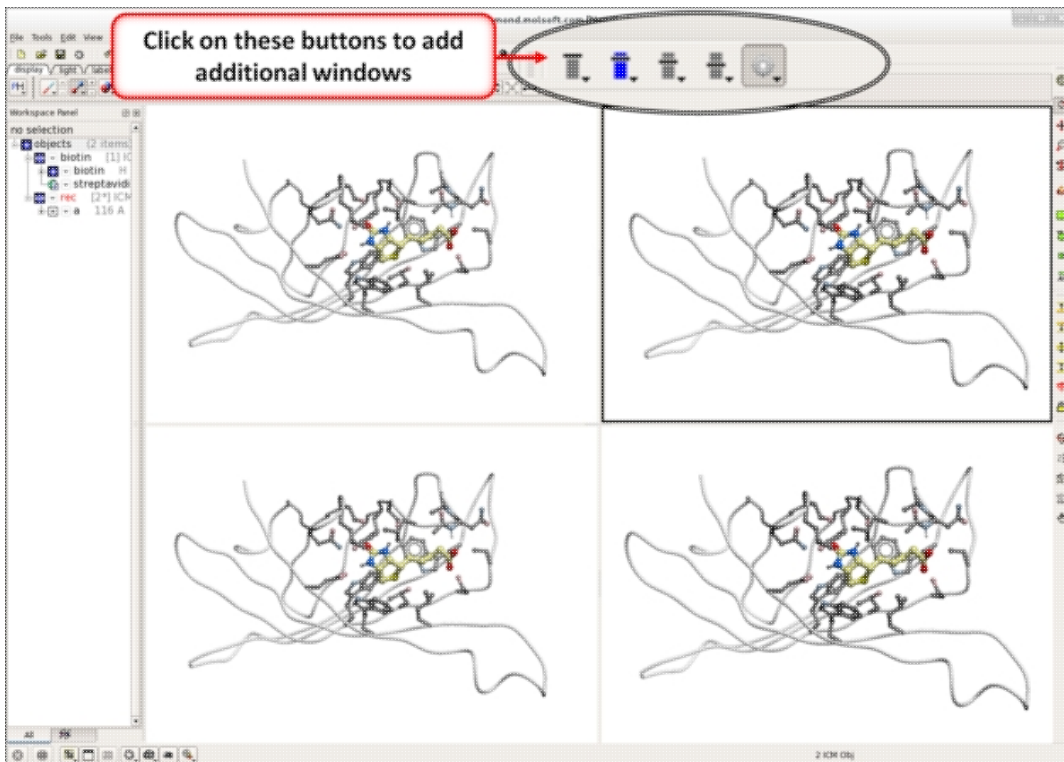

To control the layout and mouse sync mode click on the button shown below.

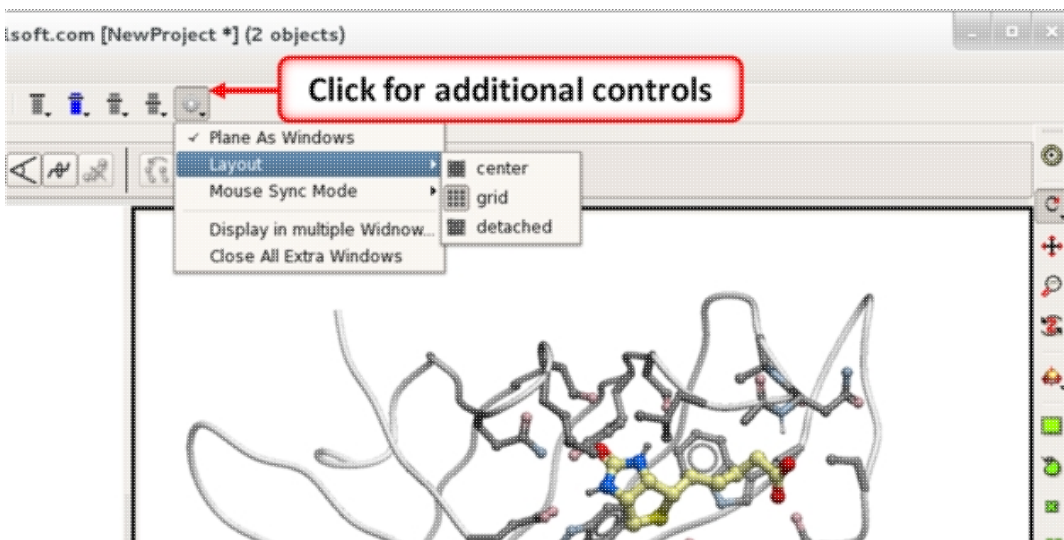

5.3 Meshes - Surface - Grobs

Available in the following product(s): ICM-Browser-Pro | ICM-Pro

Click on the tab button entitled '**meshes**' and more graphics tools for surfaces are available. In ICM surfaces are sometimes referred to as meshes or graphical objects (Grobs).

display | labels | analysis | pdb search | meshes | movie

wire |
 electrostatic |
  |
 - all - |
  |
 N | 8 | step 0. | color | MacroShape

surfaces
meshes
macroshape

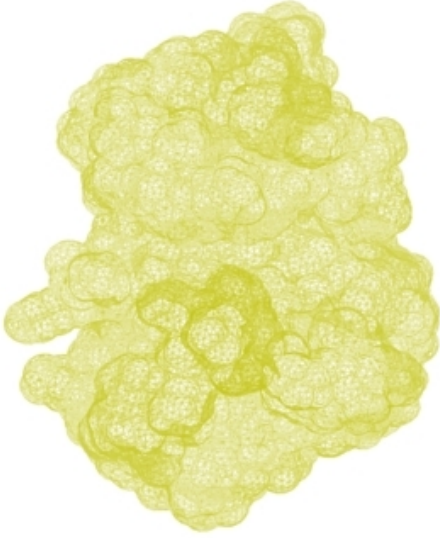
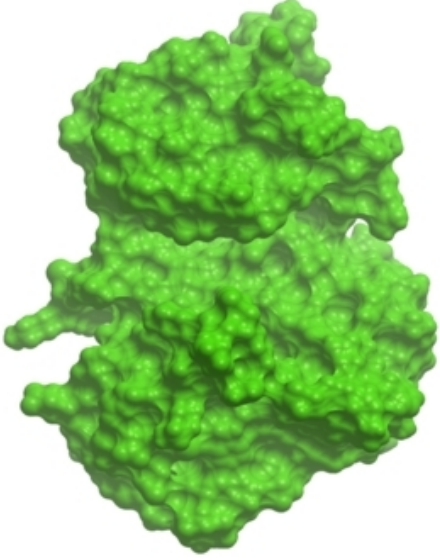
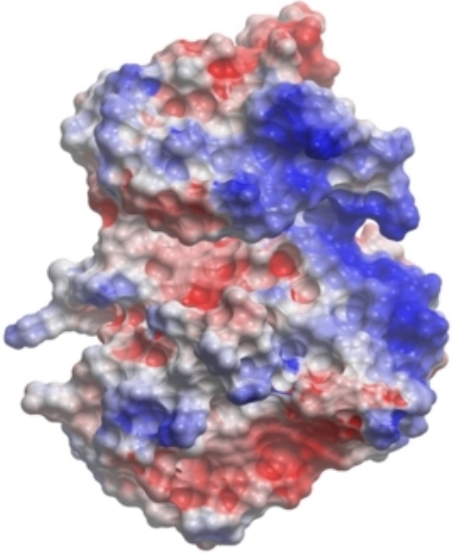
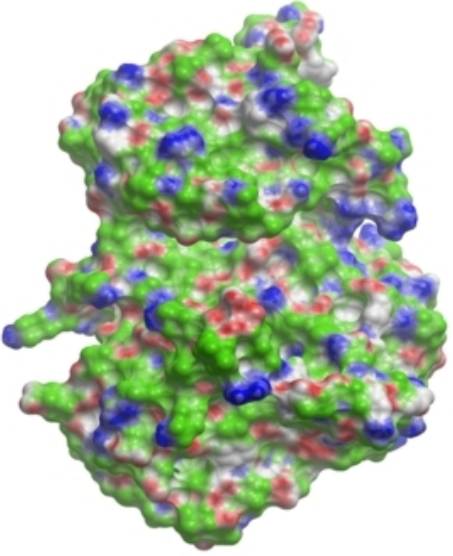
	
Surface	Plain Solid
	
Electrostatic Surface	Binding Property Surface

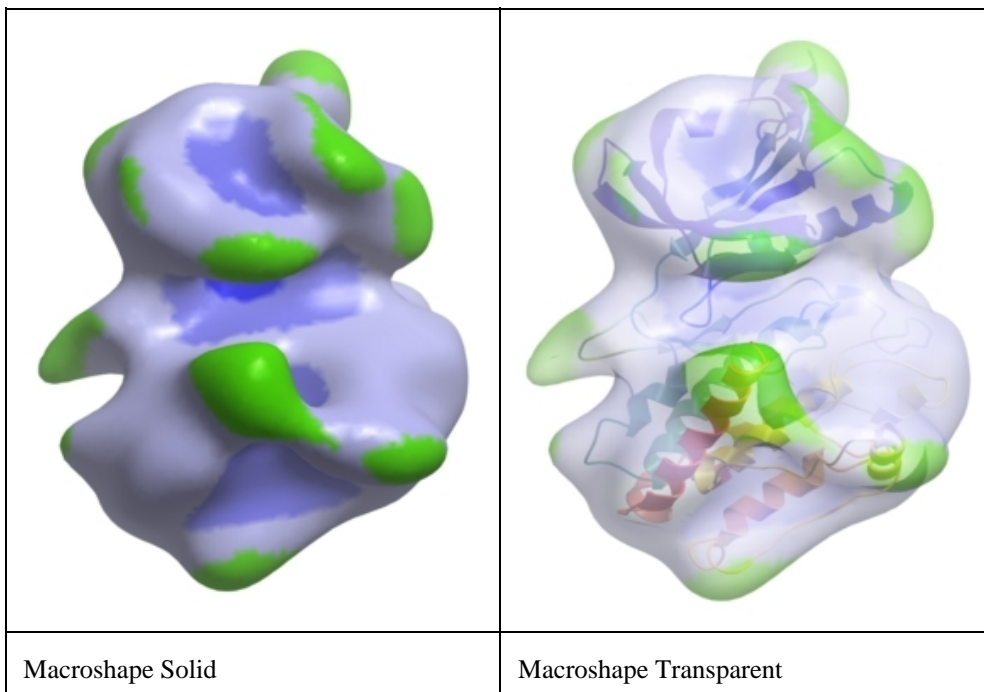

5.3.1 Surfaces

The surface of your structure can be displayed and colored by **electrostatics** or **binding** properties. To do this:

- Load a structure into ICM File/Open or tab-pdb{PDB Search}
- Convert the structure into an ICM object.
- Select the 'meshes' tab button.
- Click on the drop down arrow menu shown below and select which surface you wish to generate.
- Click on the generate surface button next to the drop down arrow.

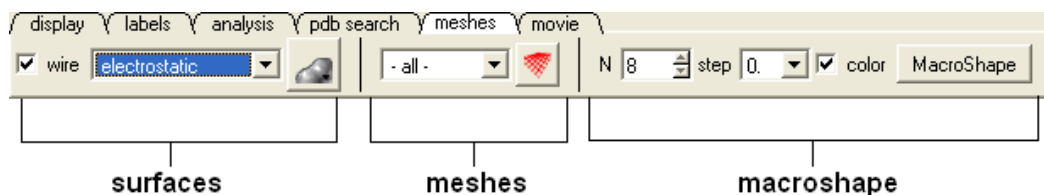

5.3.2 MolSkin

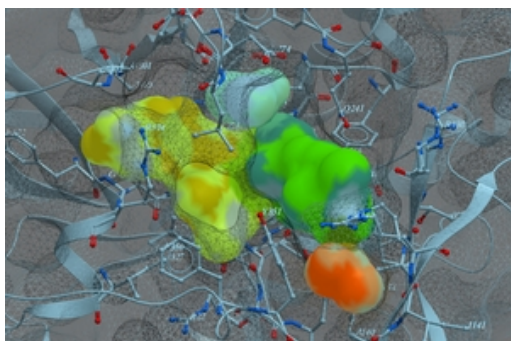

MolSkin is a new macro that instantly makes publication quality graphics and it gives each molecule a color and colors contact patches. It

undertakes the following:

- Molecular surfaces are generated with those assigned colors and occlusion shaded.
- Carbons of each molecule are colored by its own consistent color.
- Labels, ribbons, are colored accordingly.
- Surfaces are gradually cross-colored by each other to mark the contact patches.
- The labels are brought to the surfaces.

To use MolSkin:

- Right click on the object in the ICM workspace and choose Shapes/Make/Molecular Shapes and Contacts.
- Once the surfaces are made they will be listed in the ICM workspace where they can be toggled on or off.

1. Right click → Shapes/Make Molecular Shapes and Contacts

2. Toggle surfaces on and off here

3. Surfaces listed here

S	Info	G	C	T	nR	A	CA	
1	g_2sni_e	SUBT_BACAM	g_2sni_e	skyblue	A	275	10090.2	746.9
2	a_2sni_i	IC12_HORVU	g_2sni_i	yellow	A	64	4325.7	854.6

5.3.3 Color Surface by Proximity

To color a surface by proximity to neighboring molecules:

- Make a surface.
- Right click on the molecule you want to color by proximity and choose Shapes/Make/Color by Proximity.

5.3.4 Color Surface by Selection

To color a surface by a selection:

- Make a surface.
- Make a selection.
- Right click on the molecule you want to color by selection and choose Shapes/Make/Color by Selection.

5.3.5 Meshes

A variety of shapes can be constructed automatically using ICM. These shapes are referred to as meshes. The types of shapes you can build are shown in the drop down option in the meshesh tab

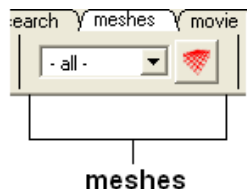

To make a shape select it from the menu by clicking on the down arrow and then click the button next to the menu. The shape will then be displayed in the 3D graphics window.

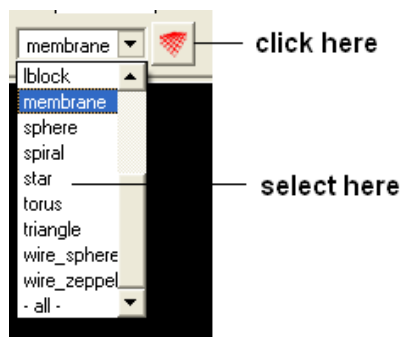

5.3.6 Macroshape

A macroshape can be constructed and allows easy viewing and manipulation of the structural representation. A macroshape representation is ideal for large structures which allows the user to easily identify important regions of the structure and facilitate the return to the 'standard' view of a particular molecule. All the buttons needed to display a macroshape structure are shown below in the 'meshes' tab.

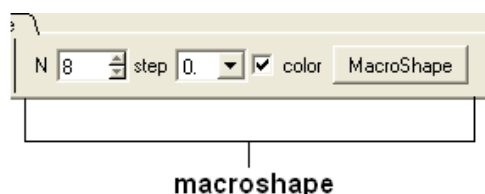

To construct a macroshape:

- Load a molecule into ICM File/Open or tab-pdb{PDB Search}
- Select the amount of detail required in the shape by increasing the values in 'N' or 'step' data entry box (note the default values are usually sufficient).
- Check the 'color' if you wish your molecule to be colored.
- Click the button labeled 'MacroShape'.

Macroshape can also be used from the View menu: View/Macro Shape

5.3.7 Google 3D Objects (Sketchup)

To read in a 3D Mesh from Google in KMZ or COLLADA format:

- File/Load/ 3D Mesh in KMZ or COLLADA Format from Google
- Search for the object you would like to view and download it.
- To read the file go to File/Open

5.3.8 Display or Undisplay Meshes or Surfaces

To display or undisplay the surface click in the box in the ICM workspace as shown below:

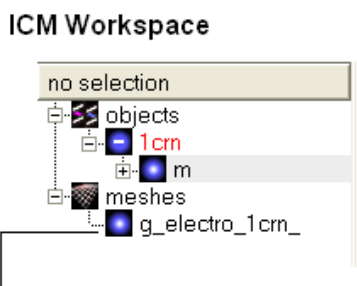

check here to display or undisplay surface

NOTE: All surfaces, meshes and macroshapes come under the one heading of **meshes** in the workspace panel.

5.3.9 Mesh Options.

A number of options relating to meshes can be found by right clicking on the mesh in the ICM Workspace. This section describes some of these options.

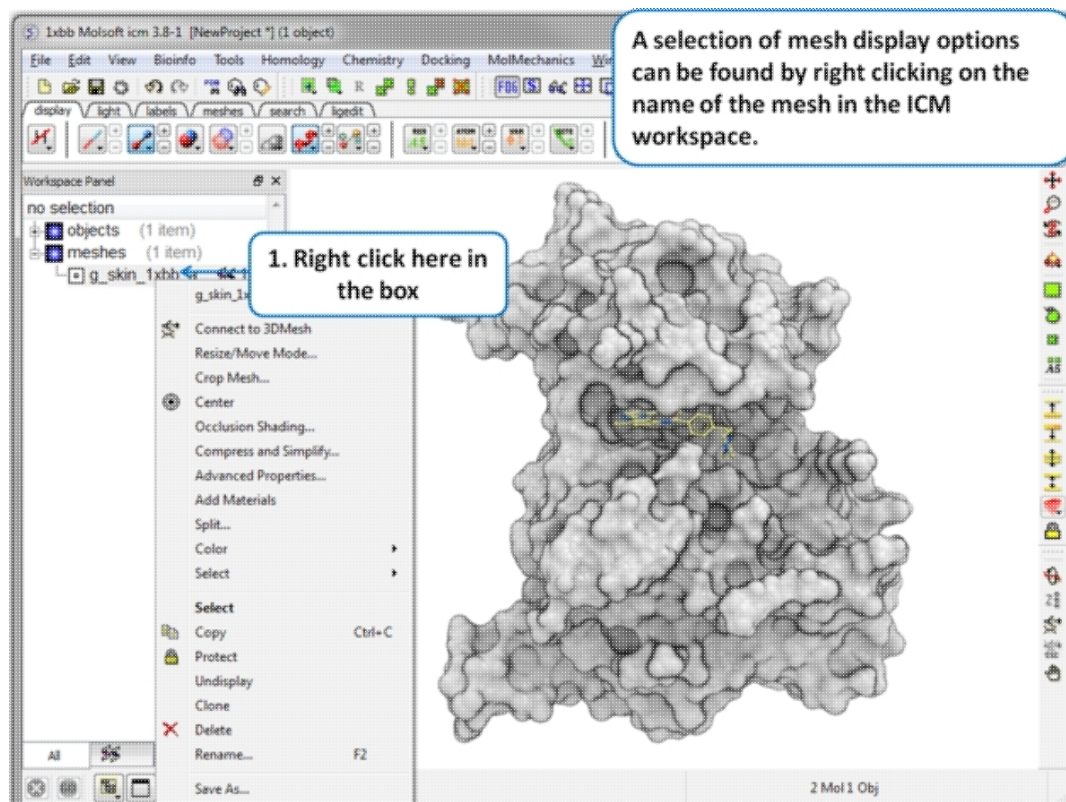

5.3.9.1 Resize Mesh

Once a mesh has been created you can move it and resize it. To do this:

- Locate the mesh in the ICM Workspace and right click on it
- Select the **Resize/Move Mode** in the menu.
- A purple box as shown below will surround the molecule.

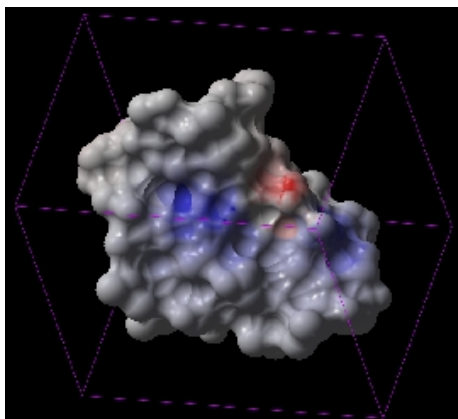

To resize the mesh click on one of the corners of the box and drag to the required size. The number displayed on the edges of the box represent the dimensions.

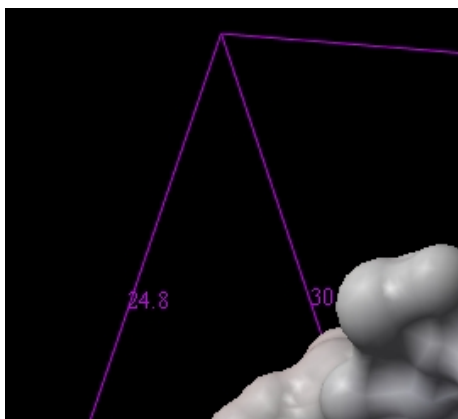

5.3.9.2 Move Mesh

To move a mesh:

- Locate the mesh in the ICM Workspace and right click on it
- Select the **Resize/Move Mode** in the menu.
- Click on the mesh in the graphical display with the **middle** mouse button.

5.3.9.3 Mesh Representation

There are five different display modes:

- Dot
- Wire
- Solid Rugged
- Solid Smooth
- Smooth Transparent.

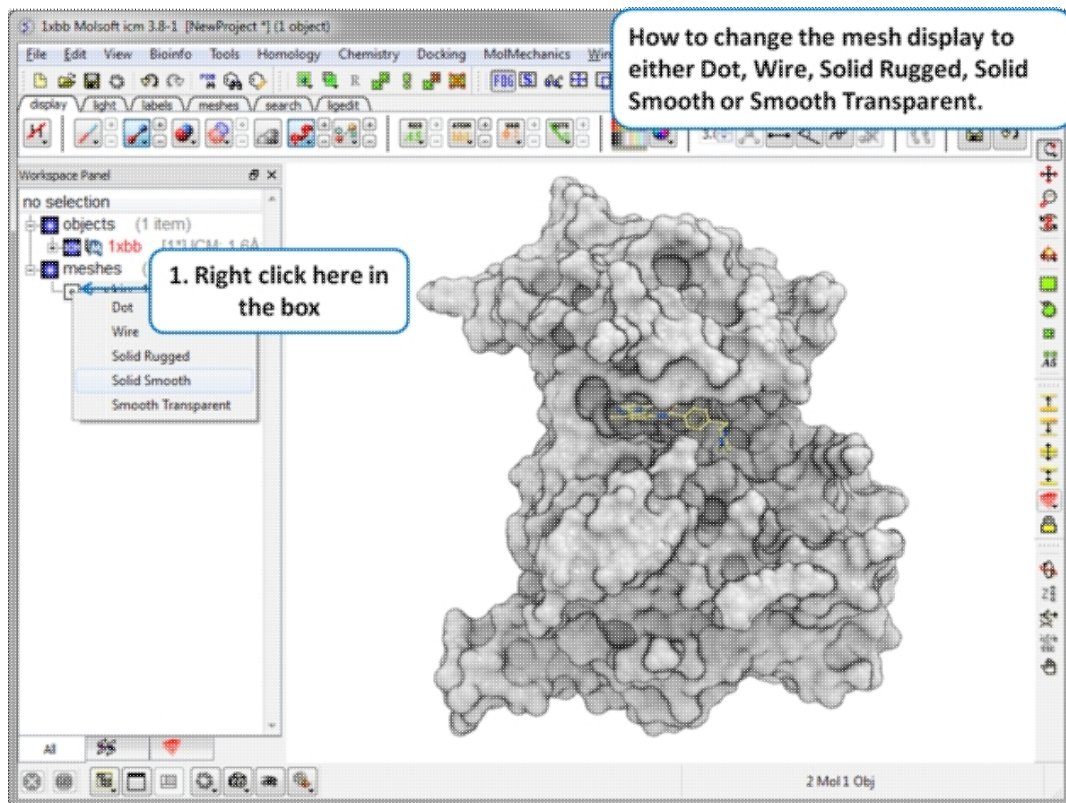

5.3.9.4 Mesh Color and Lighting

There are a number of options to color and change the display of the mesh. These options can be accessed simply by right clicking on the mesh name in the ICM Workspace as shown below.

5.3.10 Mesh Clipping

Clipping tools can be used to adjust the frames of the mesh independently of other objects.

The buttons shown below can be used for this purpose.

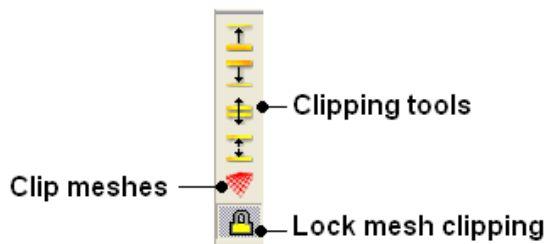

The buttons used for clipping are described in the section entitled Clipping Tools.

To clip the skin independently of the object as shown in the image above:

- Display object and mesh.
- Click and hold on clip meshes button (red button) and select Reset Clipping to Default and check the option Clipping enabled
- Click on the front clipping plane button.

- (Optional) To lock the mesh clipping click on the yellow lock mesh clipping button.

5.3.11 Save Mesh

You can save a mesh as a wavefront object by right clicking on the mesh in the ICM Workspace and selecting **SaveAs**.

5.3.12 Occlusion Shading

The occlusion shading option provides better representation of depth within a cavity. The color of each surface element of a grob (mesh) is changed by mixing its own color with the background depending on the burial of the surface element.

To add occlusion shading:

- Right click on the mesh in the ICM Workspace and select **Occlusion Shading**. The occlusion shading value can also be changed before generating the mesh in the meshes tab.
- Enter a depth value - default is 0.8. Higher values will generate a more dramatic shading.

See example here.

5.4 Coloring

Available in the following product(s): ICM-Browser | ICM-Browser-Pro | ICM-Pro

To change the coloring of molecules:

- Select the atoms, residues, molecules, or objects you wish to color in the graphical display or in the ICM Workspace.
- Then use the color options in the **Display** Tab.

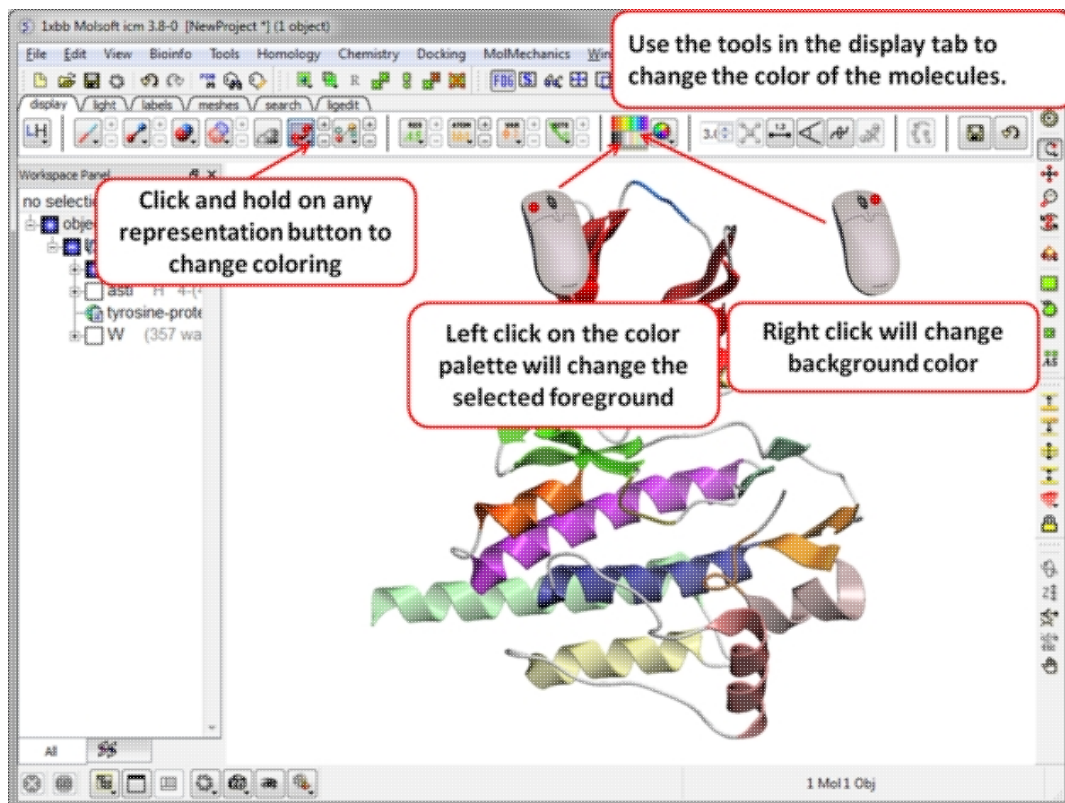

5.4.1 Coloring

To change the color of a structural representation such as CPK, Xstick, wire or ribbon.

- Select the atoms, residues, molecules, or objects you wish to color.
- Click and hold on the structural representation button for the representation you wish to color (e.g. wire, ribbon etc...) in the **Display** tab.
- Select a color by clicking color.

To color by a particular parameter such as atom type, b-factor, secondary structure etc...

- Click and hold on the structural representation button for the representation you wish to color (e.g. wire, ribbon etc...) in the **Display** tab.
- Select `..by->` option

To change the color of everything displayed :

Click on the color palette in the `Display` Tab.

5.4.2 Color Background

To change the color of the background:

- Select **View/Color** background.

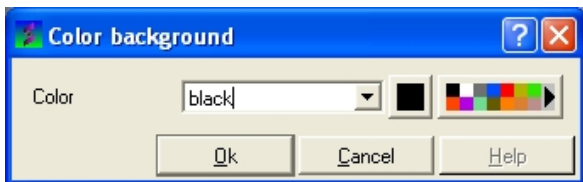

- Click on the square of your desired color. If you are not satisfied with the color palate, click on the arrow next to the colors to customize a color.

OR

- Right click on a color in the colors panel in the display tab.



Right click here in the display panel to set the background color.

5.4.3 Background Image

A background image can be added to the graphical display. This can be useful for making cool images or for comparing structures (e.g. compare displayed object with background image of object).

To add a background image from an image file (png or jpeg):

- File/Open Image
- Right click on the image in the ICM Workspace and select "Set as Background in Graphics."
- Choose one of the following: (1) Original Resoution, (2) Original Resolution Centered, or (3) Scale to Fit
- Enter the Scale (%)
- Enter whether you want to keep existing background.

To move and resize a background image: Version 3.7-2b and higher.

- File/Open Image
- Right click on the image in the ICM Workspace and select "Set as Background in Graphics."
- Choose the option **Original Resoution**.
- Click on the drag atom button (looks like a hand).
- Click and drag image.
- Remember to deselect drag atom button.

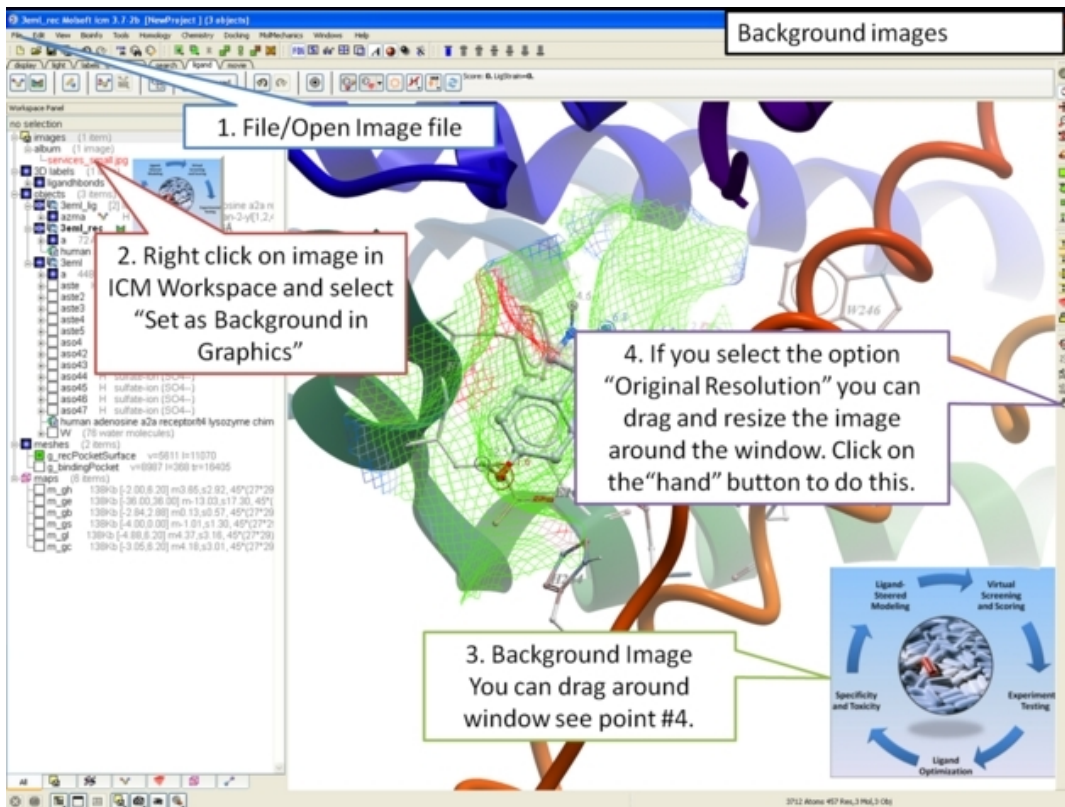

To set current display as background image:

- Click and hold on the "Copy Image to Clipboard" button at the bottom of the gui and select the "Set as Background" option.

To remove a background image:

- Select the **display** tab and then click and hold on the color sphere button and select "Remove Background Image".

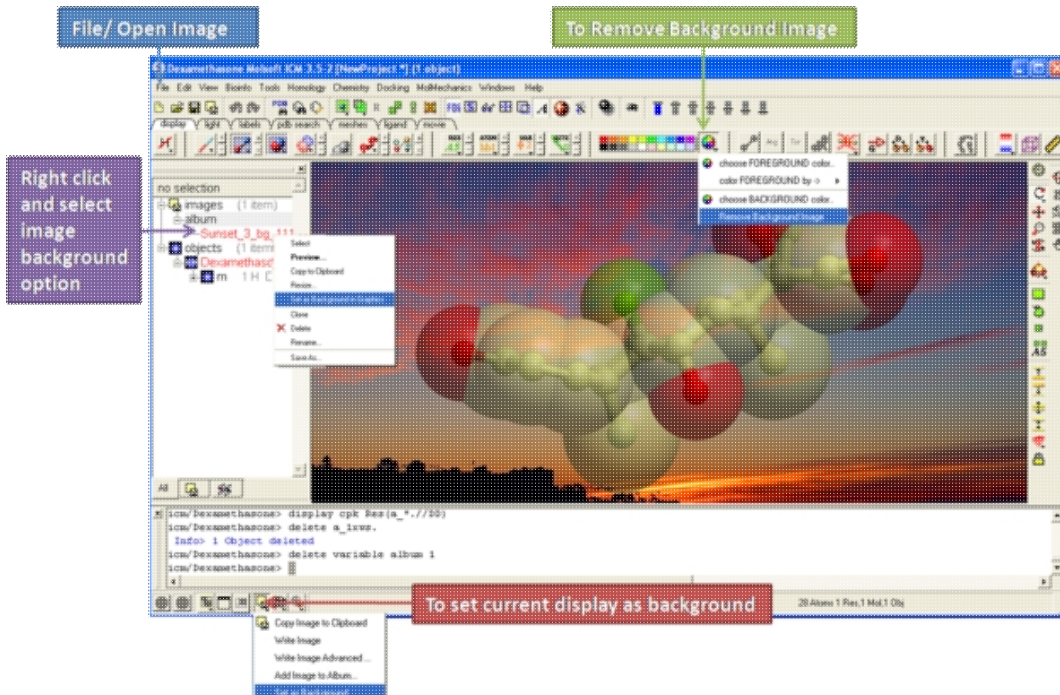

OR

- Right click on the image in the ICM Workspace and select "Set as Background in Graphics."
- Choose the option **Remove From Background**

5.5 Lighting

Available in the following product(s): ICM-Browser | ICM-Browser-Pro | ICM-Pro

These options are in the `light` tab

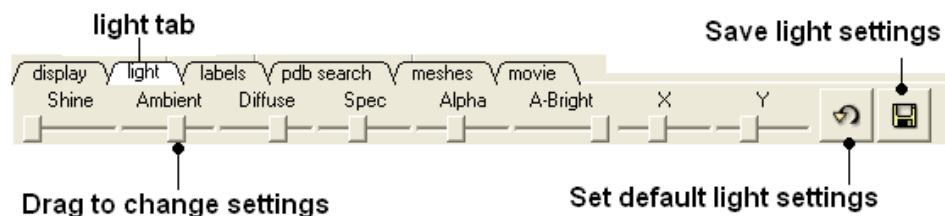

Click and drag the sliders to change the lighting. You can also save your preferred lighting settings and return to default.

Shine - shininess property of the solid material

Ambient - ambient light intensity of RGB for ambient light

Diffuse - diffuse light intensity of RGB for diffuse light

Spec - specular light intensity of RGB for specular light

Alpha - transparency setting for grob

A-Bright - light intensity shining on grob

X and Y - Change the position of the light source in the graphics window

5.6 3D Stereo

Available in the following product(s): ICM-Browser | ICM-Browser-Pro | ICM-Pro

Click and hold on the stereo hardware button (see image below).

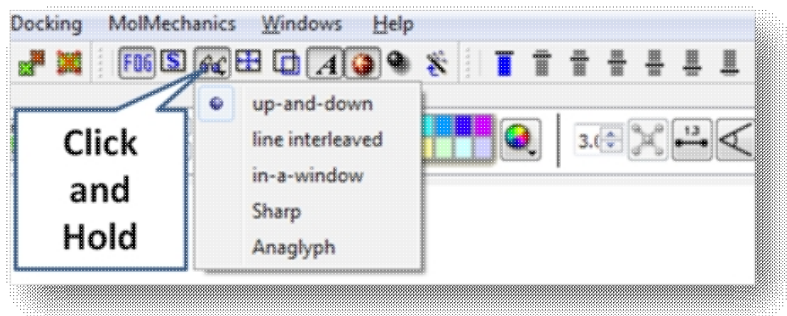

There are 5 different options available which are described here <http://molsoft.com/man/icm-table.html#GRAPHICS.stereoMode>.

1. up-and-down
2. line interleaved
3. in-a-window
4. Sharp
5. Anaglyph

The Anaglyph option is the easiest to use with inexpensive 3D glasses and without any expensive 3D compatible hardware or monitors. The 3D effect is better with a lighter background.

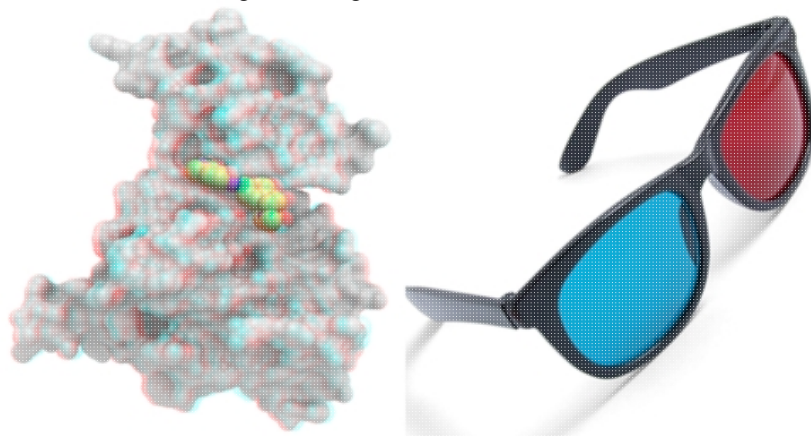

5.7 3D Printing

You can save surfaces in the STL format for 3D printing. To do this:

- Make a mesh e.g. go to the meshes tab - plain solid.
- The mesh (surface) will then be displayed in the ICM workspace (left hand side).
- Right click on the mesh and choose Save as.. and choose stl from the format option list

5.8 Labeling and Annotation

Available in the following product(s): ICM-Browser | ICM-Browser-Pro | ICM-Pro

To add labels or display or undisplay pre-defined annotation:

- Select the atoms, residues, molecules, or objects you wish to label in the graphical display or in the ICM Workspace.
- Then use the label options in the Display Tab.

To add new user-defined annotation:

- Select the atoms, residues, molecules, or objects you wish to label in the graphical display or in the ICM Workspace.
- Right click on the selection and choose "Annotate Selection".

5.8.1 Labeling

Labeling options are contained within the Labels or Display Tab. In many cases clicking and holding a label button will allow you to view more options.

5.8.2 Labeling Atoms

Select the atoms you wish to label (see `display` structure or selection toolbar).

- Select the **display** tab.
- Click the **label ATOM** button.

Click and hold to change label options

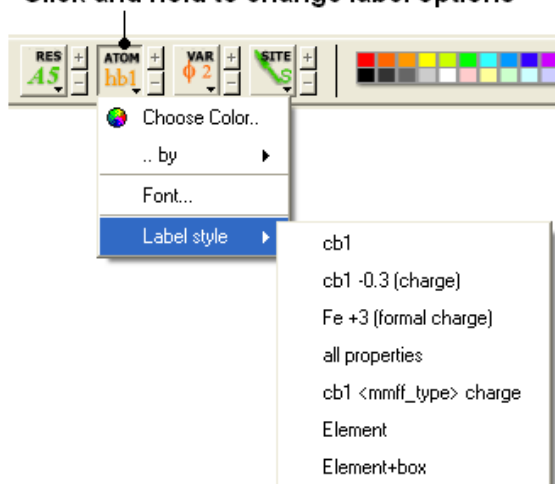

To change the level of label detail:

- Click and hold the **label ATOM** button and select the desired level of label detail, color or style.

5.8.3 Labeling Residues

To label residues:

- Select the **display** tab.
- Select the residues you wish to label (see `display` structure or selection toolbar).
- Click the **label RES** button.

Click and hold for more options

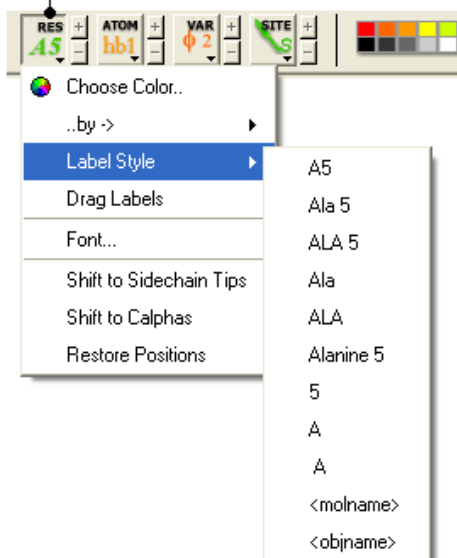

To change the level of label detail:

- Click and hold the **label RES** button and select the desired level of label detail or style.

5.8.4 Move Residue Label

To change the location of your residue label:

- Select View/Drag res labels.
- If your mouse has a middle mouse button, then click on handle (as shown) of the label you wish to move, and drag it to your desired area.

Click on
this area
to drag
your
label.



- If your mouse has no middle mouse button, then click on the Translation icon on the toolbar, and click on the handle (as shown) of the label you wish to move, and drag it to your desired area.

The +/- buttons on the side of the Residue and Atom buttons will shift the label. There are also other **residue label move** options available when you click and hold the residue label button. These options include **Shift to Sidechain Tips**, **Shift to Calphas**, and **Restore Positions**

5.8.5 Label Variables

To label variable angles (dihedral-torsion, planar and phase angle) the molecule needs to be converted into an ICM object.

- Convert the molecule to an ICM object.
- Select the atoms for which you would like to display the variables (see display structure or selection toolbar).

- Click on the **toggle variable label** button shown above located in the **display** tab.
- Change the font size by using the +/- buttons.
- Change the font and color by clicking and holding on the variable atom label button.

To change the variable label style click and hold the variable atom label button as shown below.

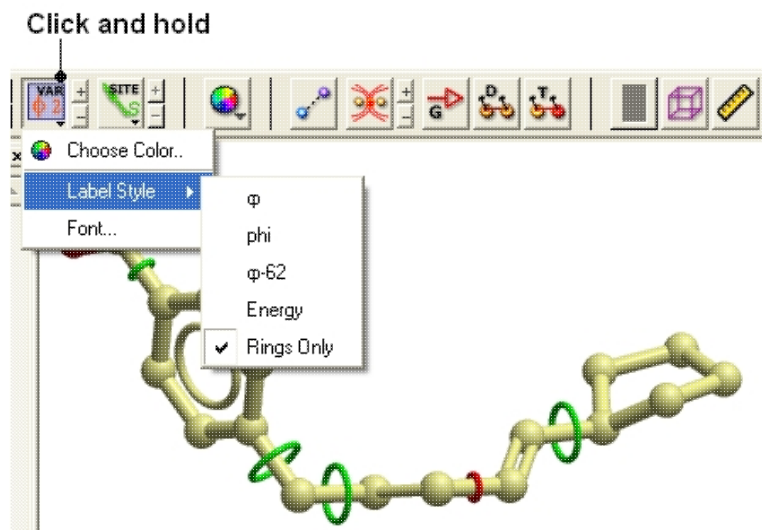

Rings of varying diameter and color are superimposed on rotatable bonds. Green rings with large diameter are considered less constrained than rings with small green rings. Red rings are highly constrained. When the **Label Style/Energy** option is selected the first number displayed represents the bond angle, the second the energy and the third the worst energy that could be achieved by rotating the bond.

5.8.6 Sites and Annotation

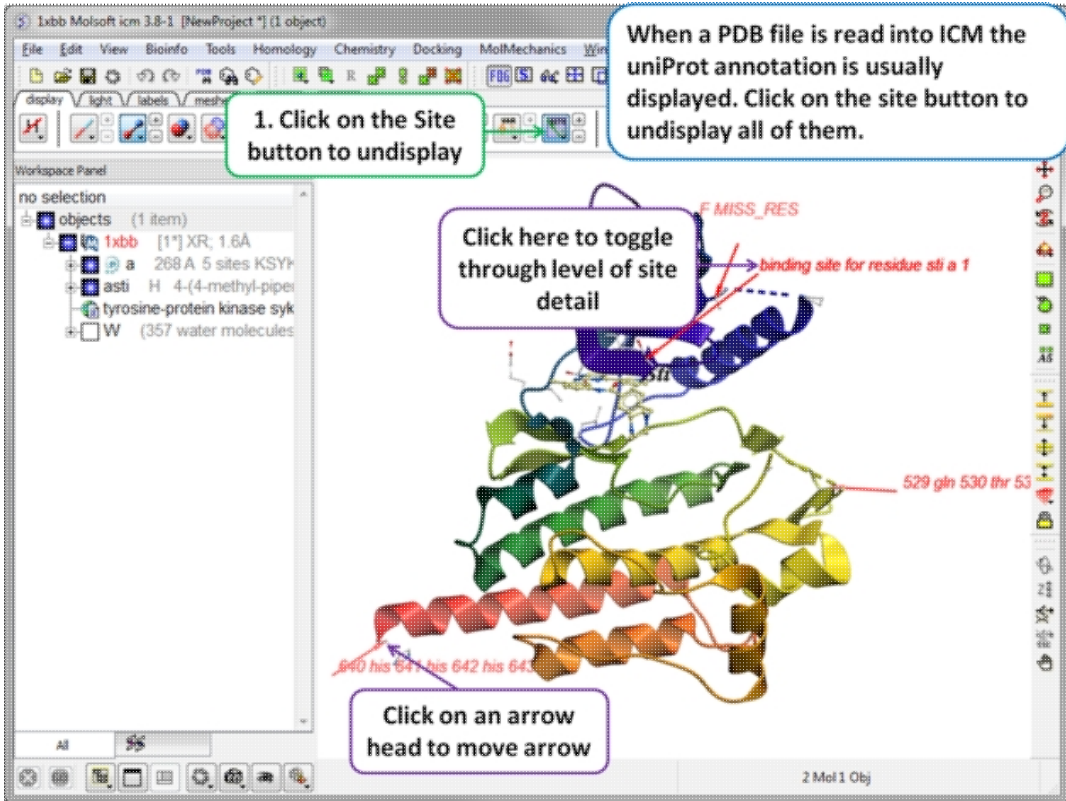

When a PDB file is read into ICM the sequence functional/mutation sites listed in Uniprot are automatically displayed. To undisplay all displayed sites click on the **Sites** button in the display tab. Click in the bottom left hand corner of the annotated site to change the level of detail or click on an arrow head to move the location.

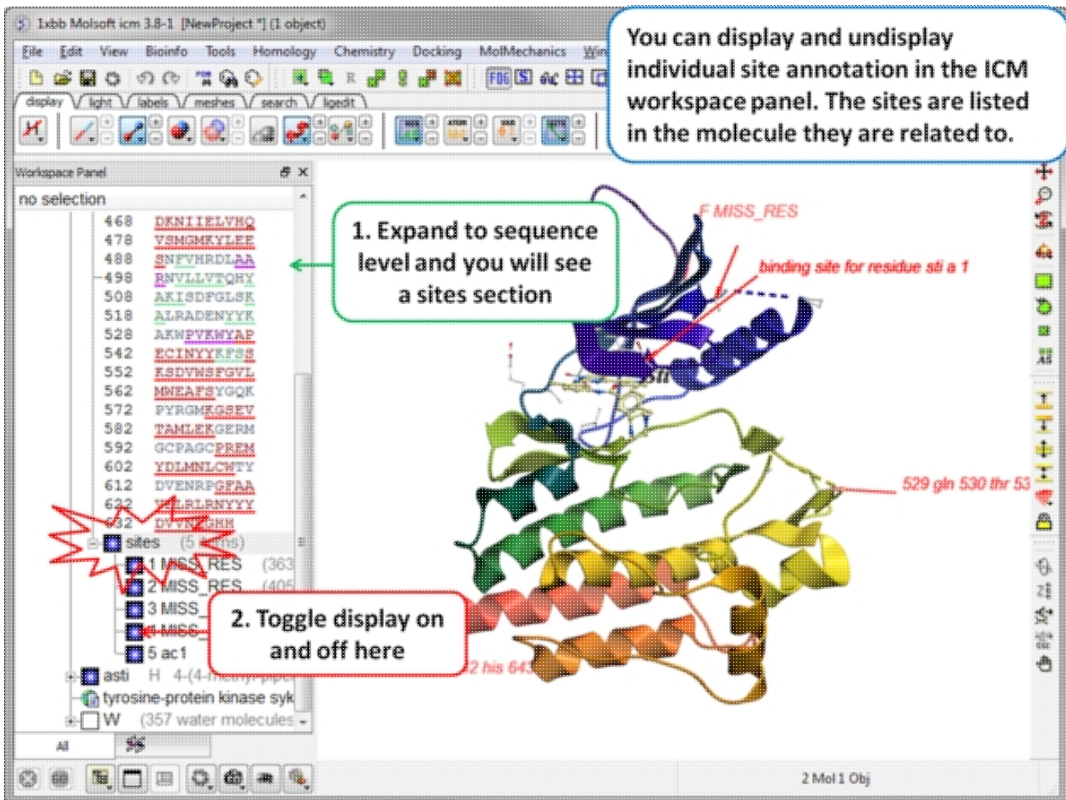

Individual sites can be displayed or undisplayed in the ICM workspace.

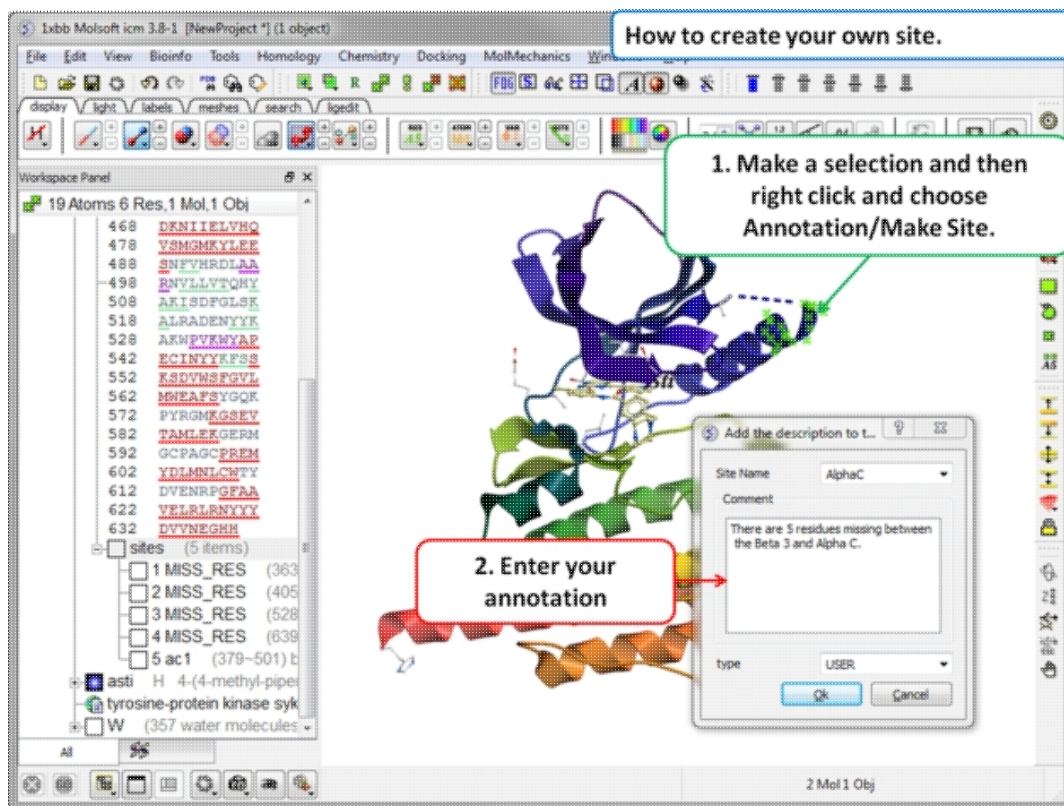

To create your own annotated site:

- Select the region you wish to annotate as a Site.
- Right click on the selection.
- Choose the option Annotate/Make Site
- Enter the annotation into the text box and select ok

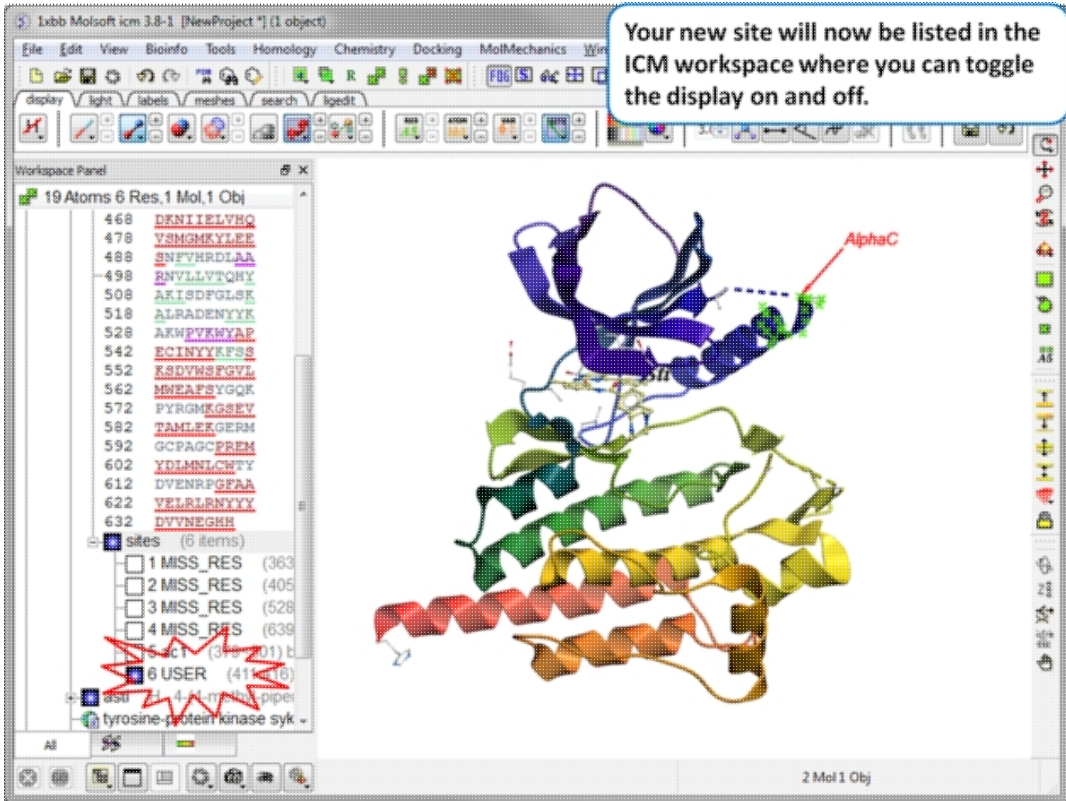

Your new site will now be listed in the ICM Workspace.

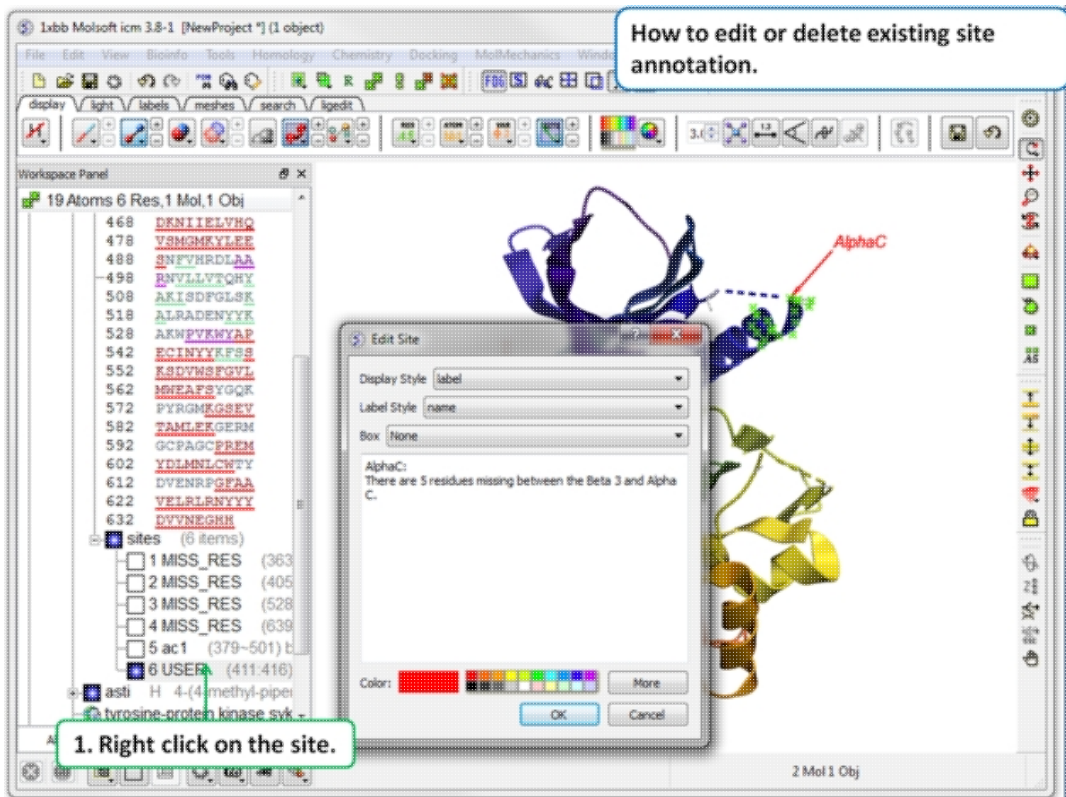

To edit or delete a site:

- Right click on the site in the ICM workspace.

5.8.7 Changing Label Colors

To change the color of any label:

- Click and hold down the required label button and a menu as shown below will be displayed.



- Select **color**.

5.8.8 Customized Label 2D or 3D

To generate a customized a label:

- Select the **labels** tab.
- Select either 2D or 3D button.
- Enter your label and select the desired color, font and size.

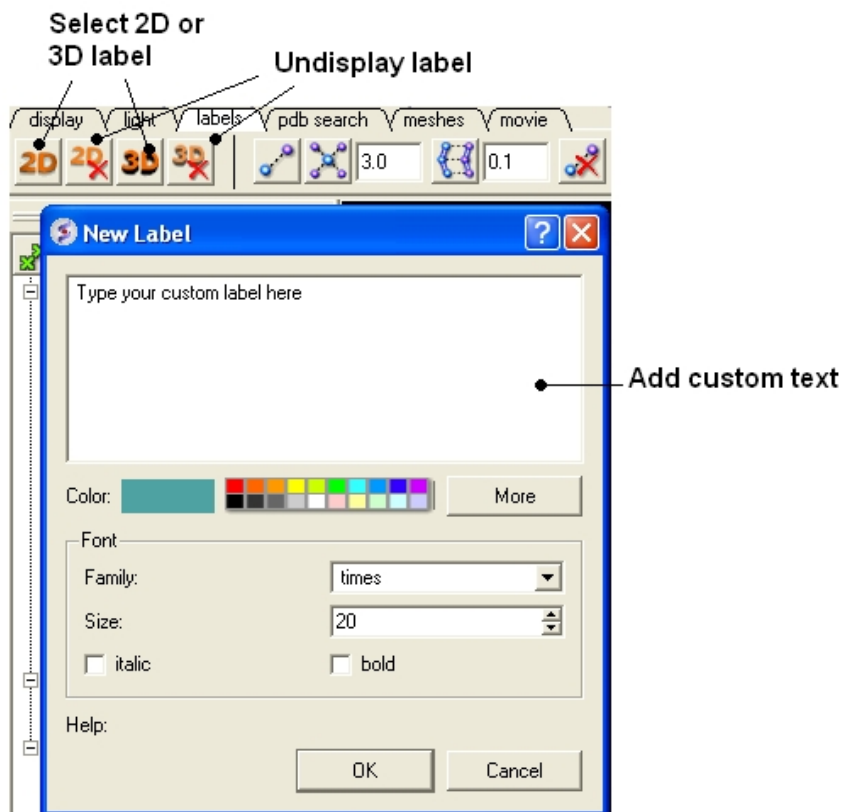

To **edit** or **delete** a label - right click on the label in the graphical display as shown below.

Right click here to Edit or Delete label

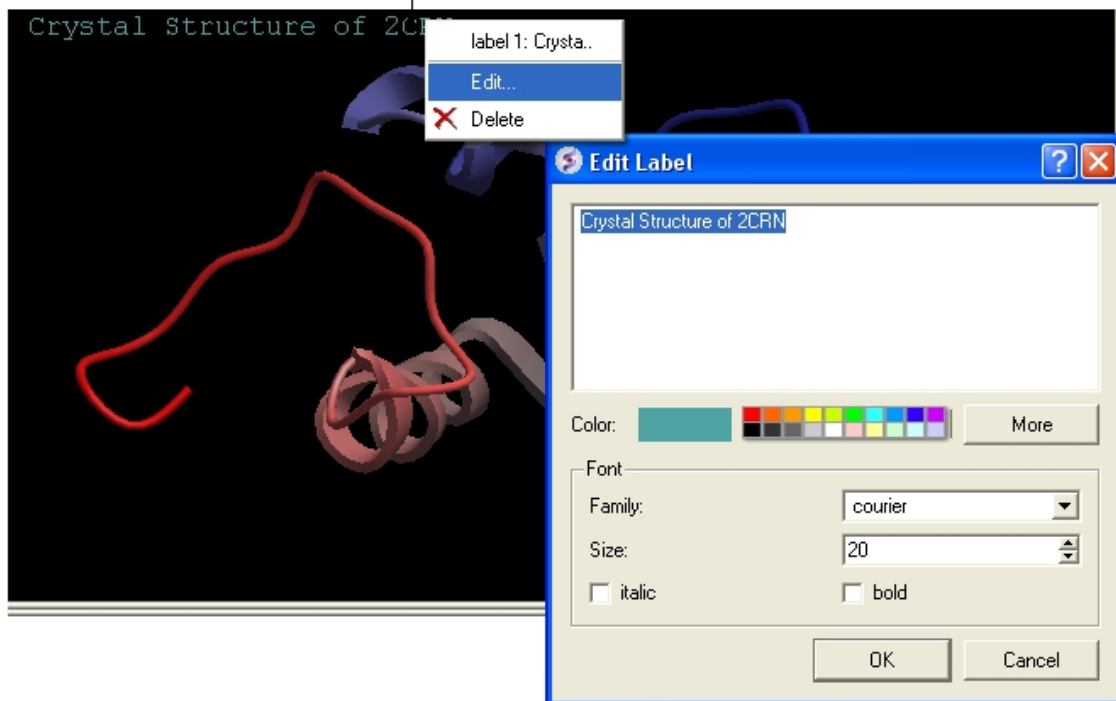

To move a custom 3D label you need to right click on it in the ICM workspace (under meshes) and choose Connect/Move independently. Press the Esc key to disconnect when you have finished moving it.

5.8.9 Undisplay Customized Label

Undisplay Residue, Atom, and Variable Label Any label that is displayed can be undisplayed by selecting the region of the molecule related to the label and clicking on the corresponding label button in the labels tab. For example if you wish to undisplay an atom label - click the atom label button. If a label is displayed the corresponding button in the **display** tab will be shaded blue. When you delete the button will return to grey. 2D and 3D labels have an undisplay button (red cross on the button see customized label section).

Undisplay 2D or 3D label Click on the undisplay label button in labels tab.

NOTE: A label can also be deleted by right clicking on the label in the graphical display and selecting **delete**.

5.8.10 Labeling Distances

Within the **labels** tab there are tools for calculating and displaying distances. These tools can also be found in the Tools/Analysis menu.

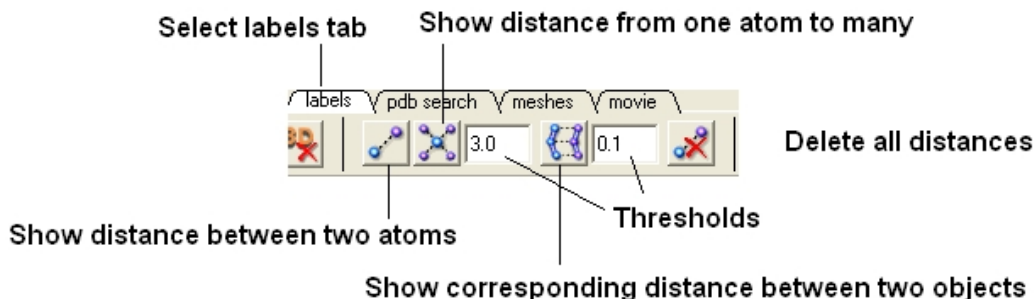

To display distance between two atoms:

- Click on the labels tab (previously called advanced tab).
- Select the atoms between which you would like to find the distance. (See `selection toolbar`)
- Click on the 'Show Distances Between Two Atoms' Button
- The distance will be displayed in angstroms, in green.

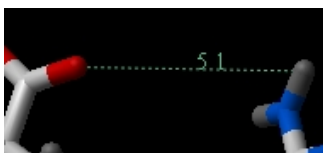

To find the distance from one atom to many:

- Click on the labels tab (previously called advanced tab).
- Select the atom from which you wish to measure the distance from (See `selection toolbar`)
- Click on the 'Show Distances From One Atom To Many' button.
- The distances will be displayed in green.

The maximal and minimal distances can be selected by entering values in the boxes shown here (below) in the labels tab (previously called Advanced tab).

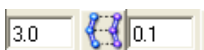

NOTE: Distances can be displayed and undisplayed in the 3D labels section of the ICM Workspace. See image below.

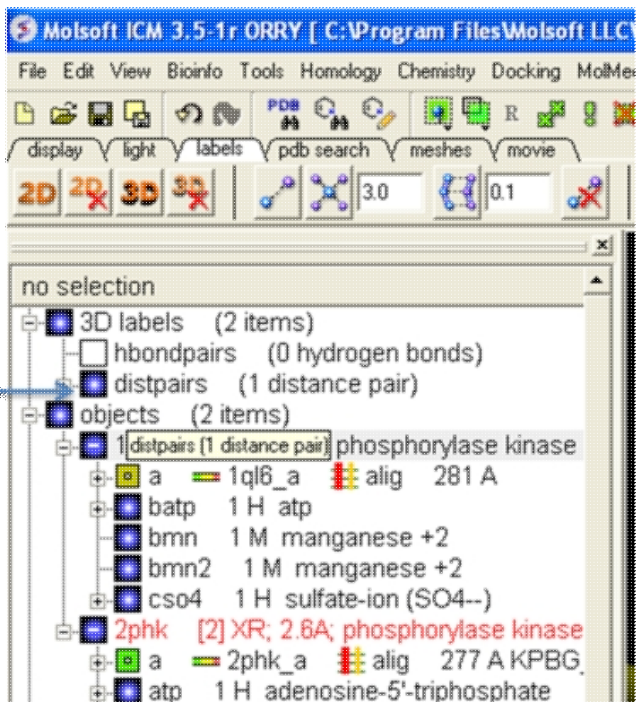

To change the color of the distance label

- Right click on the **distpairs** under the **3D labels** section of the ICM workspace and select **Change Color**.

5.8.11 (Un)display Origin

To display and undisplay the axis of the coordinate frame (**origin**):

- Select the **labels** tab and select the **toggle origin** button.

Display or undisplay origin button - located in the labels tab

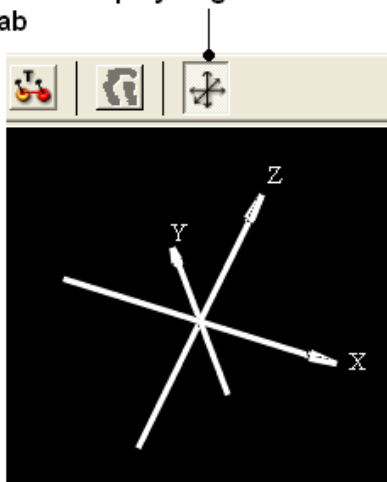

5.8.12 Displaying Tethers

Theory

A tether is a harmonic restraint pulling an atom in the current object to a static point in space. This point is represented by an atom in

another object. Typically, it is used to relate the geometry of an ICM molecular object with that of, say, an X-ray structure whose geometry is considered as a target. Tethers can be imposed between atoms of an ICM-object and atoms belonging to another object, which is static and may be a non-ICM-object. You cannot create tethers in ICM-Browser, however, if the project that you have loaded contains tethers between two objects, then they can be displayed:

- Click on the **display tab** (previously called advanced tab).
- Click on the 'Toggle Tethers' button.

5.8.13 Displaying Distance Restraints

Theory

A distance restraint imposes a penalty function on the distance between two atoms in the same object. You cannot create distance restraints in ICM-Browser, however, if the project that you have loaded contains distance restraints, then they can be displayed:

- Click on the **display tab** (previously called advanced tab).
- Click on the 'Toggle distance restraints' button.

5.8.14 Display Clash

To display a clash the file needs to be an ICM Object.

- Select the region around which you would like to identify clashes.
- Select the display tabs and the "toggle clashes" button shown below.

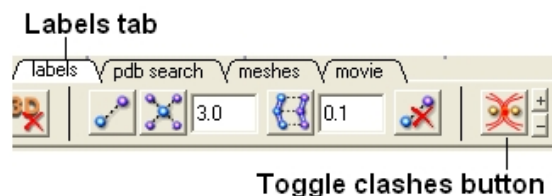

5.8.15 Display Rainbow, Box, Ruler

To (un)display a rainbow scale, box or ruler use the buttons shown below located in the Labels Tab.

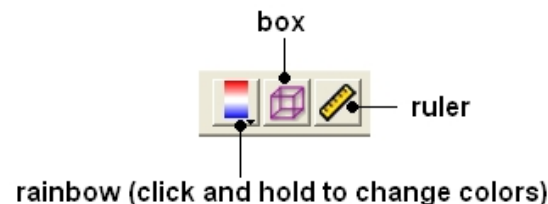

5.8.16 Display Gradient

This button is located in the **display tab**.

Toggle energy gradient button



This option is described in detail in the language manual
<http://www.molsoft.com/man/icm-commands.html#display-gradient>

5.9 Display Distances and Angles

Available in the following product(s): ICM-Browser | ICM-Browser-Pro
| ICM-Pro

5.9.1 Display Distance Between Two Atoms - the quick way

- Click on the **Display** tab
- Click on the **Distance between two atoms** button shown below.
- Click on the atoms you wish to measure.
- Distance will be displayed in the graphical display. You can turn this on and off in the ICM Workspace panel under the heading **3D labels**.



Display distance

5.9.2 Display Planar Angle

- Select the **display** tab.
- Select three atoms.
- Select the button shown below.

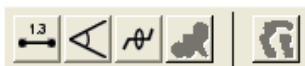

Display planar angle

5.9.3 Display Dihedral Angle

- Select the **display** tab.
- Select four atoms.
- Select the button shown below.

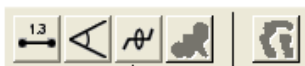

Dihedral angle

5.9.4 Delete Label

To delete distance or angle labels

- Select the **display** tab.
- Select the delete distance or angle label button shown below.

Delete distance or angle labels button in display tab



5.10 Graphics Effects

Available in the following product(s): ICM-Browser | ICM-Browser-Pro | ICM-Pro

All the visual effects tools can be accessed by the View Menu or click on the corresponding button in the View Tools panel shown below.



5.10.1 Fog

Fog Toggle(Ctrl + D) : this feature creates a fog-like environment for your object, so that the part of your structure that is closer appears clear and the distant parts are faded as if they are in fog. The clipping planes control the point at which the fog begins.

- View/Fog

5.10.2 Shadows

- View/Shadows

OR

select the shadow button shown below.

Toggle shadow



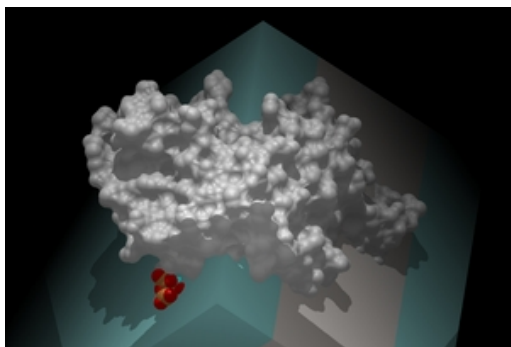

5.10.3 Sketch Accents

To make images as shown below use:

- View/Sketch Accents

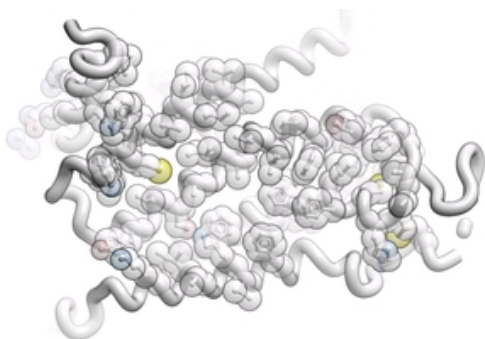

5.10.4 Elegant Ribbon & Ligand Sketch

- Display Tab
- Click and hold Hydrogen button
- Select Elegant Ribbon+Sketch

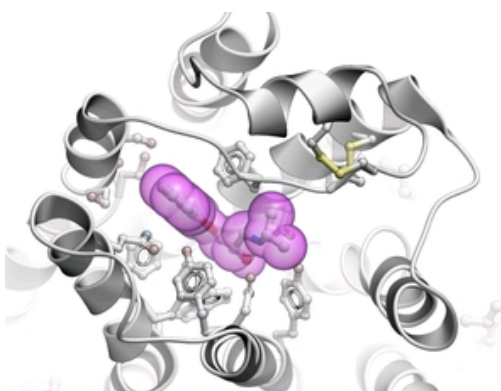

5.10.5 Occlusion Shading

Occlusion shading is for surfaces and meshes to give a perception of depth.

To add occlusion shading:

- Right click on the mesh in the ICM Workspace and select Occlusion Shading. The occlusion shading value can also be changed before

- generating the mesh in the meshes tab.
- Enter a depth value - default is 0.8. Higher values will generate a more dramatic shading.

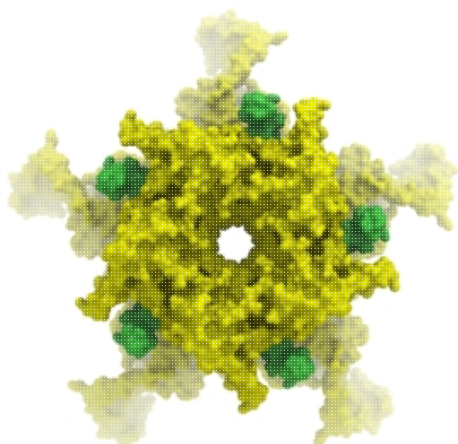

5.10.6 Perspective

Toggle perspective Ctrl_P this will add perspective to your structure, enhancing depth in the graphical display.

- View/Perspective

5.10.7 Animate View

Learn how to build fully interactive and interruptable animations.

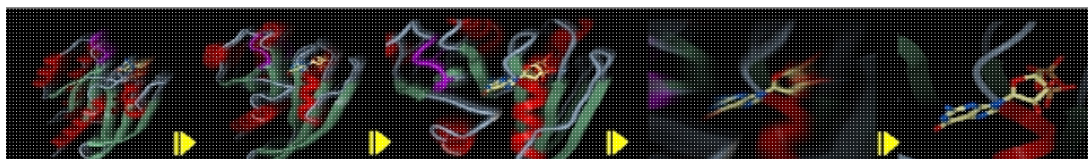

Smooth Animated Transitions

5.10.7.1 Make Animation

To quickly produce an ICM Molecular Animation:

- Click and hold down the "Begin rocking/rotation" button shown in the picture below.
- Choose from the following options - X-Rock, Y-Rock, Xy-Rock, xY-Rock, X-Rotate, and Y-Rotate.

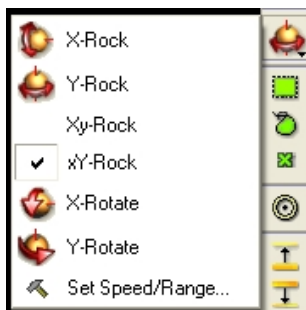

Click and HOLD DOWN the Begin rocking/rotation button

NOTE: Default rocking representation can be changed in the File/Preferences/Gui menu.

5.10.7.2 Change Speed, Range and Cycle Length of Animation

To change the speed, range and cycle length of the animation:

- Click and hold down the "Begin rocking/rotation" button shown in the picture above.
- Choose the set speed range option and change the speed and range using the drag bars. Any change will appear in the graphical display behind this box.
- If desired you can change the number of cycles of the animation. This is an ideal tool for screen-shot movie making.

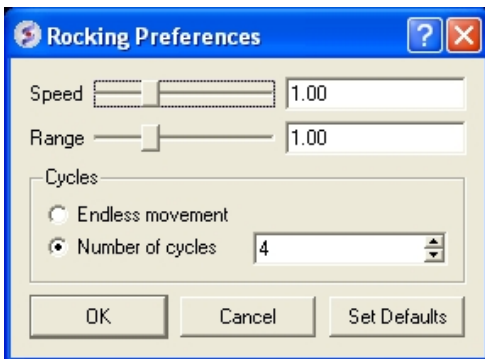

NOTE: There is a return to default button in the Rocking Preferences dialog box shown above and default values can be changed in File/Preferences/Gui.

NOTE: Default rocking speed can be changed in the File/Preferences/Gui menu.

5.10.7.3 Interrupt Animation

An ICM Animation or Transition is fully interactive and is interrupted by a single click of the mouse.

To stop or change an animation or transition:

- Click the "Begin rocking/rotation" button shown in the picture below.

To temporarily halt an animation or transition:

- Click in the graphical display. Once you release the mouse button the animation will start again.

NOTE: If you click on the graphical display during an animation the animation will be interrupted. Whilst clicking and holding the mouse button other operations can be performed such as zooming and selections.

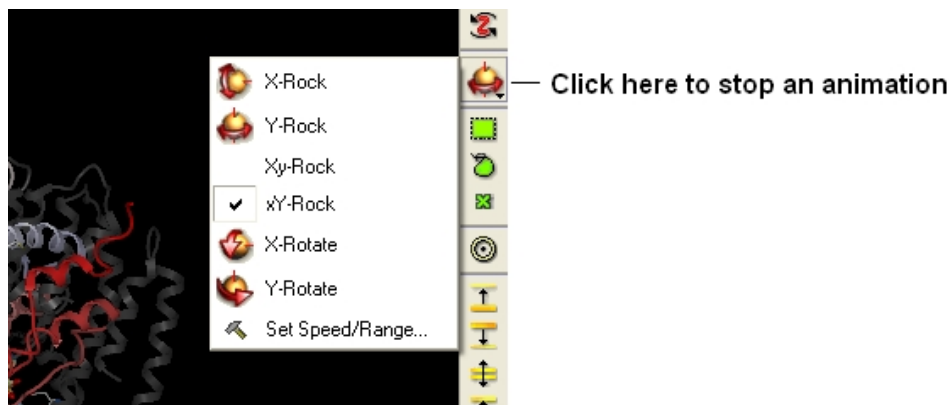

Click in the graphical display window to temporarily interrupt an animation

5.10.7.4 Saving an Animation

An animation can be saved in an ICM project:

File/Save Project

Or

as a slide.

5.11 Graphics Shortcuts

Available in the following product(s): ICM-Browser | ICM-Browser-Pro
| ICM-Pro

The left mouse button can be mapped onto different graphics tools which can be selected from the right hand tool bar.

Note: (1) You can access many non-rotation modes directly from the rotation mode by using Middle and Right-mouse buttons, as well as by using the right, top and left margins of the graphics window. (2) You can access the rotation mode from non-rotation modes by pressing Ctrl.

- rotation (**the default** , press Ctrl if you in the non-rotation modes)
- translation (the middle mouse button in the rotation mode)
- zooming in and out by dragging the mouse up and down (the left margin in the rotation mode, or use the mouse **wheel**)
- Z-rotation (the top margin in the rotation mode)
- selecting by box (the right mouse click in the rotation mode)
- selecting by lasso (Ctrl-draw lasso in the rotation mode)
- picking out atoms (a toggle)
- picking out and labeling residues (a toggle)
- moving the front clipping plane (the top section of the right margin in the rotation mode)
- moving the rear clipping plane (the bottom section of the right margin in the rotation mode)
- moving the slab (the middle section of right margin in the rotation mode)
- unclipping (Ctrl-U)
- rotating torsions (Ctrl-left-mouse-click in the rotation mode)

- connect and unconnect separate molecules to movement controls

Many useful graphics tips are summarized here.

NOTE: Key mouse controls are summarized in the command line manual here <http://www.molsoft.com/man/graphics-controls.html>

5.12 Molecule Move Buttons

Available in the following product(s): ICM-Browser | ICM-Browser-Pro | ICM-Pro

To move your structure it must first be displayed in the graphics window (for instructions on how to display a structure see the **Display** Tab). All of the following options are displayed in the Move Tools toolbar (shown below).

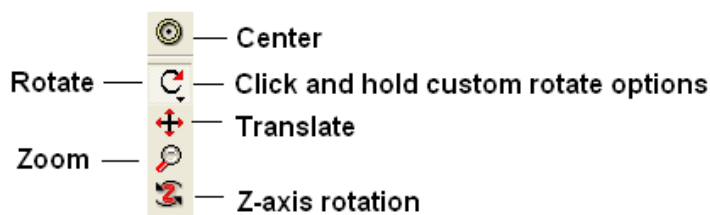

5.12.1 Rotation

In order to achieve the best pose for a picture or to enable the study of a certain region of your structure in more detail you may need to rotate the structure:

- Click on the **rotation** icon on the toolbar.



- Click and drag on your structure in the display window until it is in the desired position.

5.12.2 Custom Rotation

An option is provided to customize the rotation of the molecule. This allows exact rotation by a specified number of degrees.

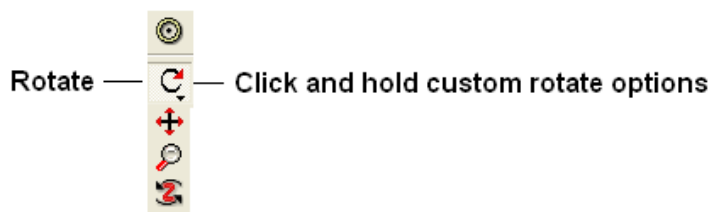

- Click and hold down the rotation button and a data entry box as shown below will be displayed.
- Enter the number of degrees of rotation you require and in which X, Y or Z coordinate.

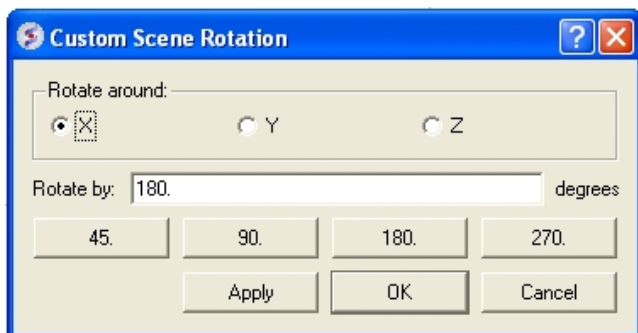

To continuously rotate the picture:

- Click on the **continuous rotation** icon on the toolbar.
- Click, hold, and slightly move your mouse anywhere on the graphical display window. The point at which you hold your mouse, is the direction to which the object will turn.
- Positioning the mouse towards the center of the display will move the object slower than if the mouse is positioned towards the edge of the graphical display.

In order to rotate your picture around the Z-axis:

- Click on the **Z-axis rotation** icon on the toolbar.



- Click and drag your object around the Z-axis until it is in the desired position.

5.12.3 Translation

To translate your structure up, down, left, or right:

- Click on the **translation** icon on the toolbar.

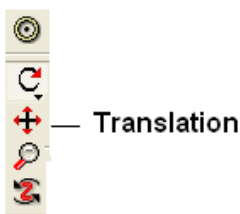

- Click and drag on your structure in the display window until it is in the desired position.

When you are displaying more than one object and you wish to translate one object in relation to the other on the Z-axis:

- Right click on the name of the object you wish to move in the ICM workspace and select connect to object. This object is now independent from the other object and can now be manipulated separately.
- Click on the **Z translate** icon on the toolbar.
- Click and drag your structure along the Z-axis, moving it closer or further from your unconnected structure.
- Once you are finished, right click on the name of the object which is connected, and click on disconnect.

5.12.4 Zoom

To zoom in or out of your structure:

- Click on the **zoom** icon on the toolbar.



- Click and drag your mouse up to zoom in and down to zoom out.

You can also zoom in and out directly with the right-mouse-button *without* explicitly switching to the zoom tool, if you use the **left 5%-margin** of the graphics window.

5.12.5 Center

To restore your picture to the center of the graphical display window or to center on a selection:

- Make a selection of the region you wish to zoom into - if no selection is made the whole structure will be centered.
- Click on the **center** icon on the toolbar.



5.12.6 Torsion Angles

To alter the torsion angle of certain residues of your structure manually:

- Convert your pdb structure into an ICM object.
- Click on the **change torsion angles** icon on the toolbar (see image below).
- Click on the bond until you see the torsion angle displayed in yellow (see image below). Click and hold on the bond around which you wish to rotate a residue. The changing torsion angle will be displayed in orange.

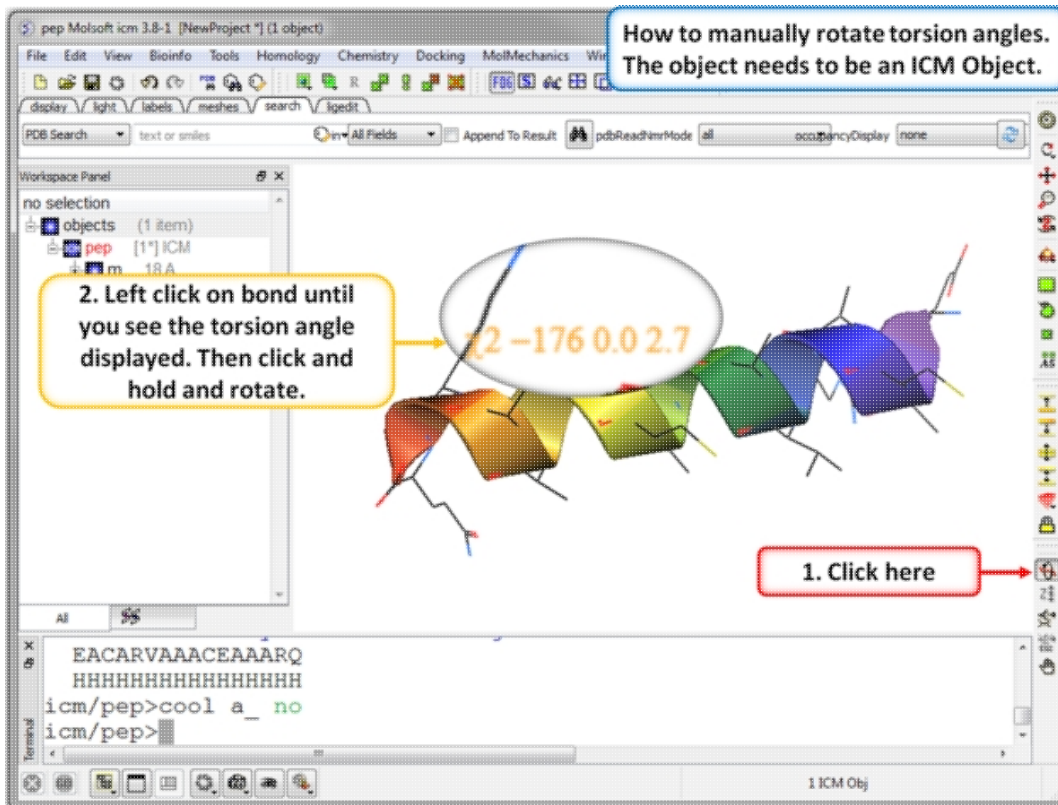

NOTE: This option can be used more effectively in conjunction with the variable label option.

To alter torsions by entering specific angle values:

- You can edit torsions by specifically defining the exact angle as described here.

5.12.7 Connect (Move)

When there is more than one object displayed in the graphical display window the objects are connected to one another. If you wish to move or manipulate one object independently from the others you need to **connect** to it

To do this from the ICM Workspace:

- Right click on the name of the object you wish to move in the ICM workspace and select **Connect to Object**. The object will now be colored yellow.

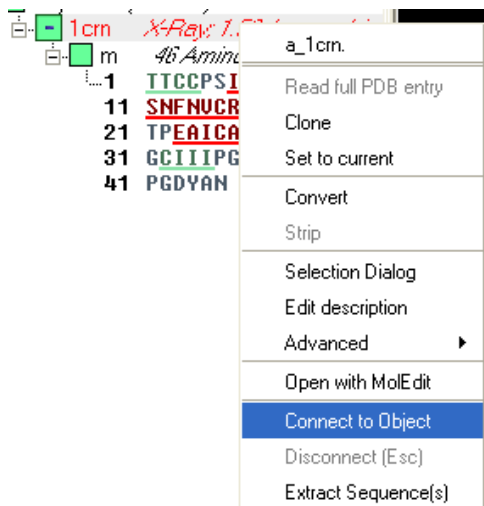

- The object is now controlled separately from the rest of your objects by your mouse.
- Disconnect your object by once again right clicking on the name of the object in the ICM Workspace and selecting disconnect in the drop down menu or **Press the ESCAPE key**.

Note: you can temporarily switch to the global rotation in the connected state if you press Shift

Note: use the Escape button to disconnect

5.13 Clipping Tools

Available in the following product(s): ICM-Browser | ICM-Browser-Pro | ICM-Pro



The clipping tools allow you to adjust the frames of the ICM window, changing the clipping planes.

Clipping planes can also be moved *without* switching to the clipping tool, if you click the right hand margin of the graphics window:

- The top section of the right 5% margin of the graphics window: moves the back clipping plane
- The middle section of the right 5% margin of the graphics window: moves the slab (both clipping planes)
- The bottom section of the right 5% margin of the graphics window: moves the front clipping plane

In order to move the front or rear clipping planes of your screen:

- Click on the **Move front clipping plane** or **Move rear clipping plane** icons on the toolbar.
- Click and drag the respective plane forward or backward, depending on how you wish to clip it.

You can also move the **slab** of viewing window, keeping the distance between the front and back clipping planes. In order to adjust the area

of the structure where your viewing window is located:

- Click on the **Slab** icon on the toolbar.
- Click and drag the slab forward or backward, depending on the desired area of the structure you wish to see.

If you have made changes to the clipping planes which you do not wish to keep or you wish to automatically fit your entire structure within the clipping planes:

- Click on the **Unclip** icon on the toolbar. This will automatically set the clipping planes to fit your object.

5.13.1 Mesh Clipping

Clipping tools can be used to adjust the frames of the mesh independently of other objects. This is described here.

5.14 Graphic Layers

Available in the following product(s): ICM-Browser | ICM-Browser-Pro | ICM-Pro

To display and undisplay layers of a structure you can use the buttons shown below. Seven layers can be created and within each layer different structural representations can be displayed.



Right click on one of the layer buttons and a number of options can be chosen as shown below.

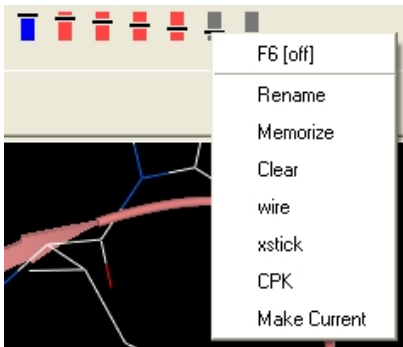

To change the display in one of the layers:

- Right click on one of the layer buttons.
- Select a representation wire, xstick or CPK.
- You can do this for each of the seven layer buttons.
- Click on the layer button to display and undisplay. If the layer button is shaded red then the layer is not displayed. If the layer button is shaded light blue then it is displayed. You can switch between layers by clicking on the button or using the. You can use the **memorize** button to store a particular representation and **clear** to remove a memorized representation.

5.15 High Quality Publication Images

5.15.1 High Quality Image

To make high quality publication images:

The first step is to improve the quality of the image using the **High Quality Image** and **Antialias** buttons shown below.

antialias



high quality image

To save and write an image:

- Select **File/Write Image** and the following window will be displayed:

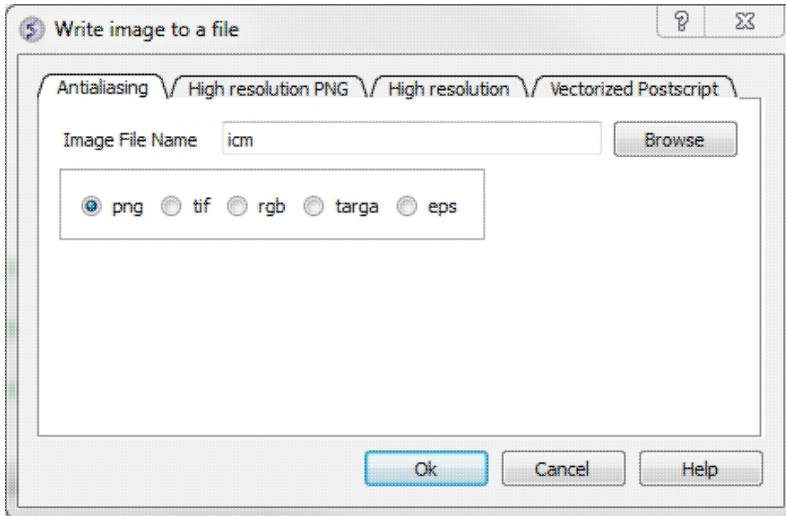

Choose one of the tabs depending on the image type you require:

- **Antialiasing** allows you to make png, tif, targa, eps or rgb file types.
- **High Resolution PNG** Allows you to specify a resolution increase and transparent background.
- **High Resolution** Allows you to specify a resolution increase for tif, targa and rgb files.
- **Vectorized Postscript** This creates a vectorized postscript model of the screen image. Instead of the bitmap snapshot this command generates lines, solid triangles and text strings corresponding to the displayed objects. Since the postscript language is directly interpreted by high-end printers, the printed image may be even higher quality than the displayed image. The final resolution is limited only by the printer since the original image is not pixelized. Warning: there may be inevitable side-effects for some types of solid images at the intersection lines of solid surfaces (i.e. large scale cpk representation, hint: use display skin instead).

****NOTE:** With some graphics drivers the high resolution image may be distorted or multiple representations of the image in one frame. Please see the FAQs for a solution to this.

5.15.2 Quick Image

A quick image can be saved using this option. The image will be saved as `icm1.png` in the current directory in which you are working. Each subsequent image produced will be incrementally numbered.

This option is also available via a button as shown below:



Quick Image Button

5.15.3 Image Options

Click and hold on the **image** button at the bottom of the GUI to:

- Copy image to clipboard (single click on the button also does this).
- Resize image (Write Image Advanced)
- Transparent Background Write Image Advanced)
- Store an image in ICM (Write Image Advanced)
- If you are making an ICM document you may want to store images inside ICM (Add Image to Album).

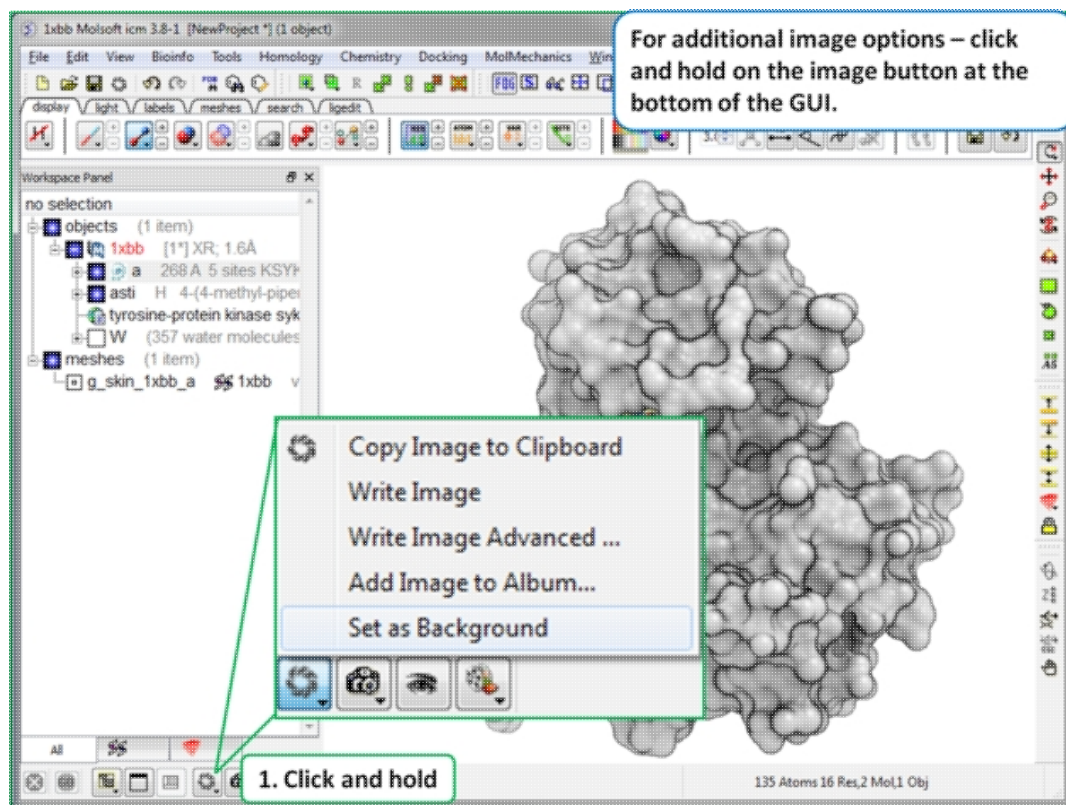

5.16 Movie Making

Available in the following product(s): ICM-Browser-Pro | ICM-Pro

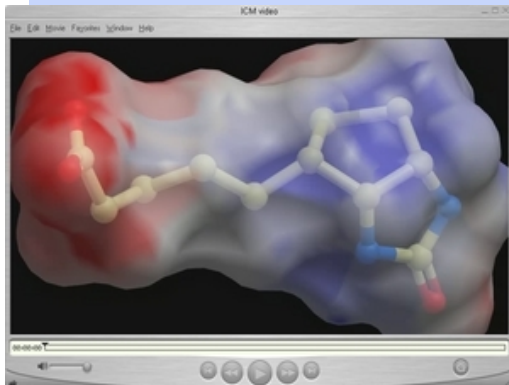

A movie is an excellent way of communicating 3D structural data. The resulting movie can easily be transferred into other applications such as Microsoft Powerpoint.

There are two ways to make a movie:

- Make a movie directly from a series of slides.
- Make a movie directly from screenshots.

An alternative to a movie is a fully interactive 3D document embedded in Windows PowerPoint or a Web Browser, this can be undertaken using slides and the ActiveICM plugin.

5.16.1 Making a Movie from a Set of Slides

To make a movie from a set of slides:

Make a series of slides using the camera button at the bottom of the screen.

2. Slides are listed here

```
icm/lxbb>add slide display="-layout" 3
icm/lxbb>add slide display="-layout" 4
icm/lxbb>
```

1. Make Slides

2 Mol 1 Obj 1 pos. ID=0(0%)

Make a series of slides using the camera button.

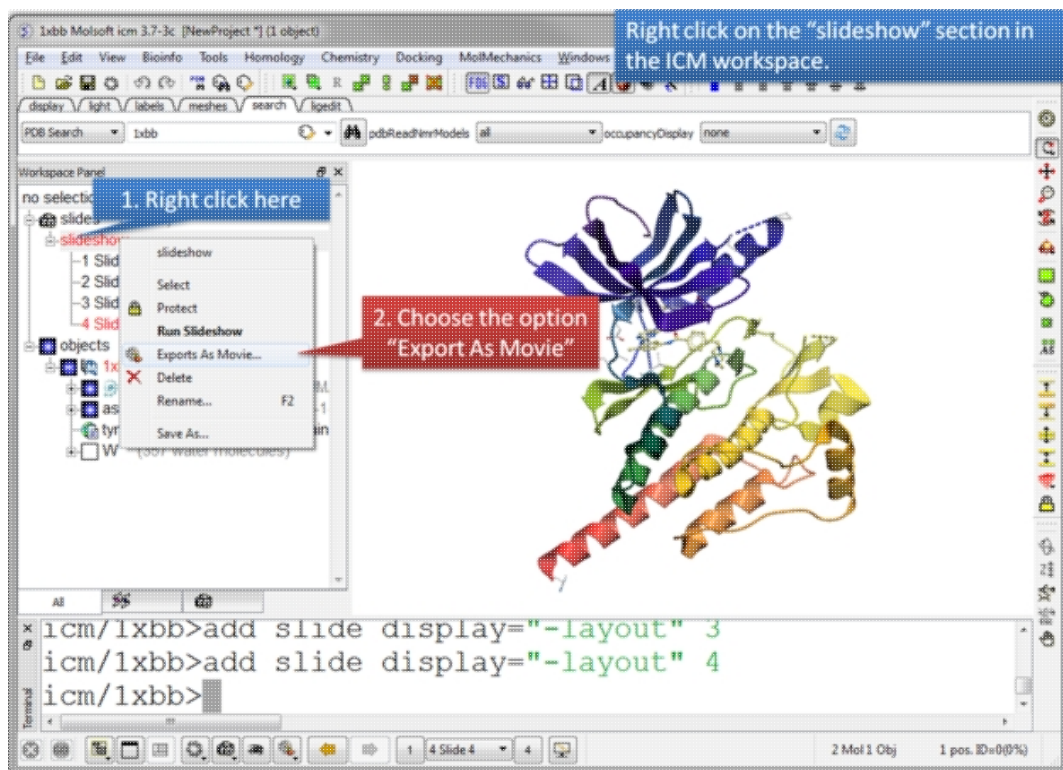

Right click on the slideshow in the ICM Workspace and choose the option "Export as Movie".

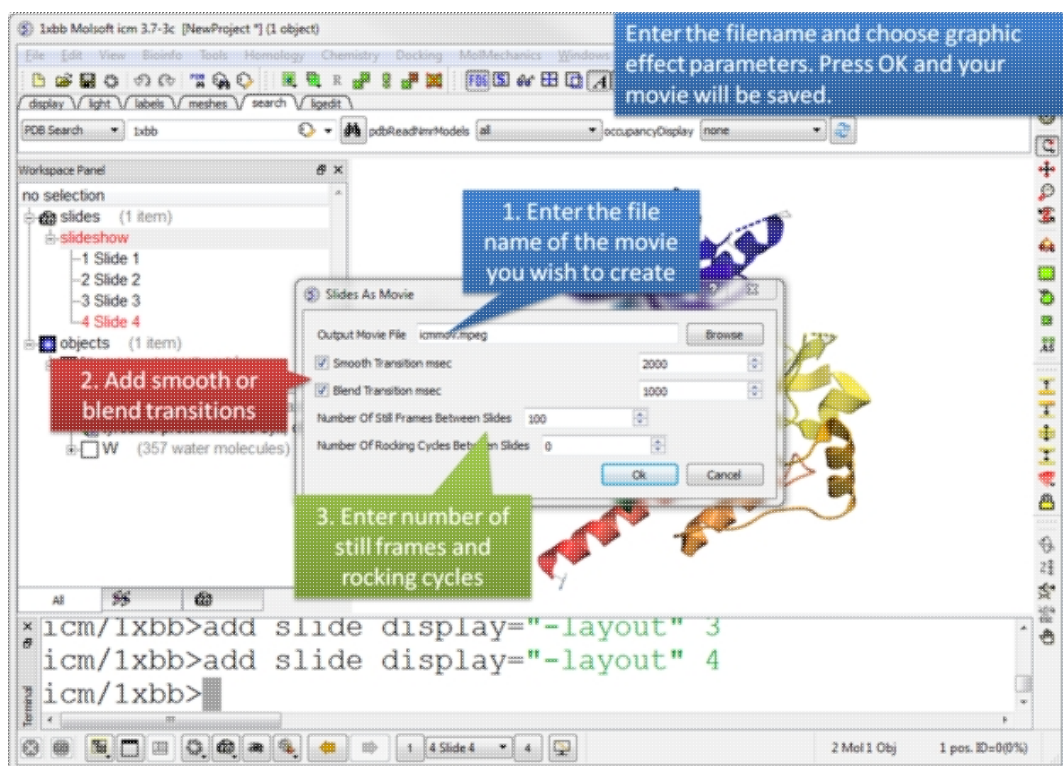

Enter the filename for your movie and set the movie effect parameters. Press OK and the movie will be written to a file.

5.16.2 Screenshot Movie



Screenshot movie making

To make a **Screen-grabbing Movie** follow these steps:

- Resize the graphical display to the screen size/resolution you need. You may also want to select the **high quality image** button and antialiasing to improve the quality of the movie or add visual effects such as **shadows**.
- To begin making a movie click on the movie making button at the bottom of the graphical user interface (as shown below).
- Enter a file name for your movie and select the movie format (.mov, .avi, mpeg).

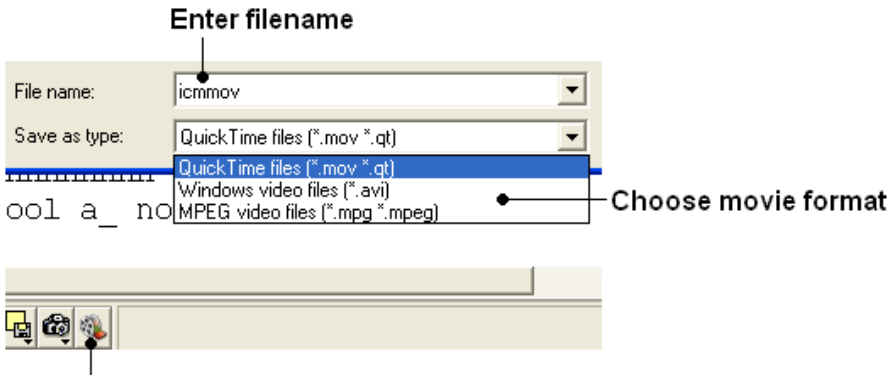

Screenshot movie making button

NOTE: If you want to make a movie to include in a PowerPoint presentation you need to save the movie in AVI format.

- To begin recording the screenshot movie click on the red **Record video** button. Anything displayed in the graphical display will be recorded, for example you can record animations and transitions. Specifying the number of cycles in the animation (rocking, rotation) is an ideal tool for screen-shot movie making. If you have a fast computer you can use **Realtime screen grabbing** which can be selected by clicking and holding the **Record video** button. The real time option can also be set in File/Preferences/Gui menu.



Record video button

- The length of the movie in minutes, seconds and milliseconds is displayed in the top right hand corner of the graphical display.



- You can pause the movie and fade out by clicking on the button shown below. The number of frames for the fading out option can be controlled using the option in `File/Preferences/Gui`

Pause and fade out

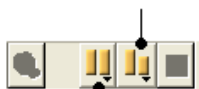

Pause recording

- You can record a smooth transition from a previous frame by clicking on the button shown below.

Smooth transition from previous frame



NOTE: Anything you do in the graphical display will be recorded in the movie. For example you can change representations, lighting, add new molecules etc. This can be achieved in a more controlled manner using the **pause** and **record smooth transition** button.

- Once you have paused the recording the viewpoint and representation of the molecules can be changed and a smooth transition from the previous frame can be generated by selecting the **Record smooth transition from previous frame** button.
- To stop recording a video press the button shown below.

Record smooth transition from previous frame



Stop recording

6 Slides & ActiveICM

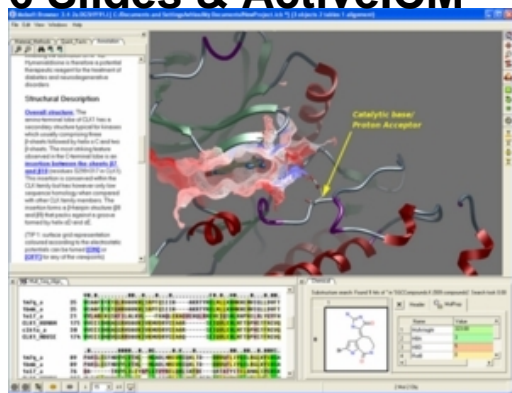

In this chapter you will find a description of the tools available to create files (.icb) containing fully-interactive three-dimensional (3D) molecules and two-dimensional (2D) data. These files can contain multiple interactive views and animations of molecular structures and objects in conjunction with related hyperlinked text, chemical, biological sequence, alignment and data views. The files are small and easily transferable and downloadable. The files can be used

for Molecular Presentation and Documents inside the ICM browser or displayed on the web and in PowerPoint using the ActiveICM plugin. For examples of ICM Molecular Documents please see MolSoft's ActiveICM product page at www.molsoft.com/activeicm.html

Chapter Contents:

- Making Molecular Slides
- How to View and Navigate Slides
- How to Edit Slides
- How to Add Smooth Blending and Transition Effects Between Slides
- How to Make Molecular Documents - Link HTML Text to Slides
- ActiveICM - ActiveICM enables you to view and display ICM graphical slides and animations interactively inside Windows Microsoft PowerPoint and web browsers such as Internet Explorer and Mozilla Firefox.
- IcmJs is a JavaScript/HTML5 version of the ActiveICM plugin.

6.1 Making Slides

Available in the following product(s): ICM-Browser | ICM-Browser-Pro | ICM-Pro

A slide enables you to store a large number of different 3D visualization along with text and window layout. The following information can be stored in a slide:

- Viewpoint (e.g. rotation, translation, zoom, lighting and depth effects)
- A set of atom-specific graphical representations such as surfaces, which can be represented as smooth, transparent or wireframe, ball-and-stick models, CPK (space-filling) models.
- A set of atom, residue or distance labels on any of the atomic items
- A set of arbitrary 3D textual annotations assigned to a point in space
- A set of arbitrary 2D annotations assigned to specific 2D coordinates on a screen
- Parameters of the parametric animation
- Window layout - for when the slides are viewed in the browser.
- Current table(s)
- Sequences and Alignments
- HTML text with hyperlinks
- 2D images
- For each grob (mesh): representation and colors.

A slide can be made by clicking on the Camera button at the bottom of the GUI.

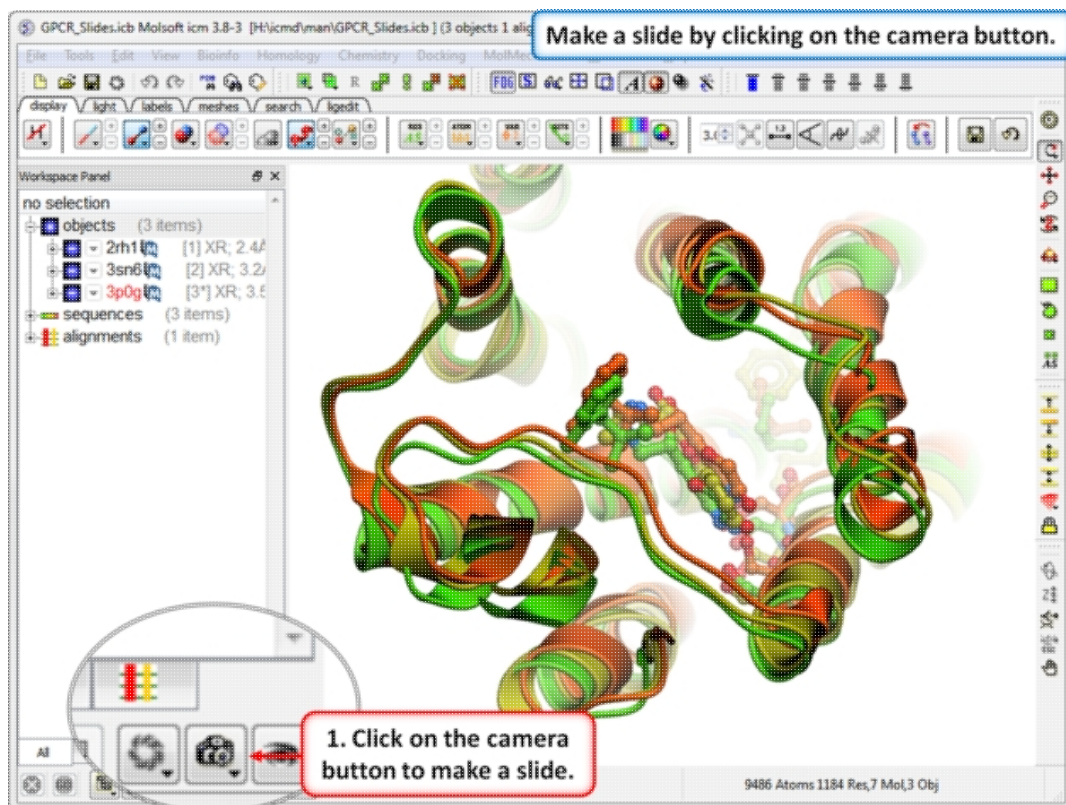

Slides can be viewed in the GUI, can be edited and graphical effects can be added to them. Slides can also be embedded into the web, or PowerPoint using ActiveICM or viewed in ICM-Browser (or ICM-Pro).

This tutorial takes you through the steps to create a series of fully interactive 3D slides. Another tutorial can be found here. **To begin making ICM Molecular Slides:**

- First load the structure or structures you wish to display in your first slide. Additional structures, labels etc and text can be added at any point during the slide making process. In this example we will load the PDB file 1XWS a PIM1 kinase.

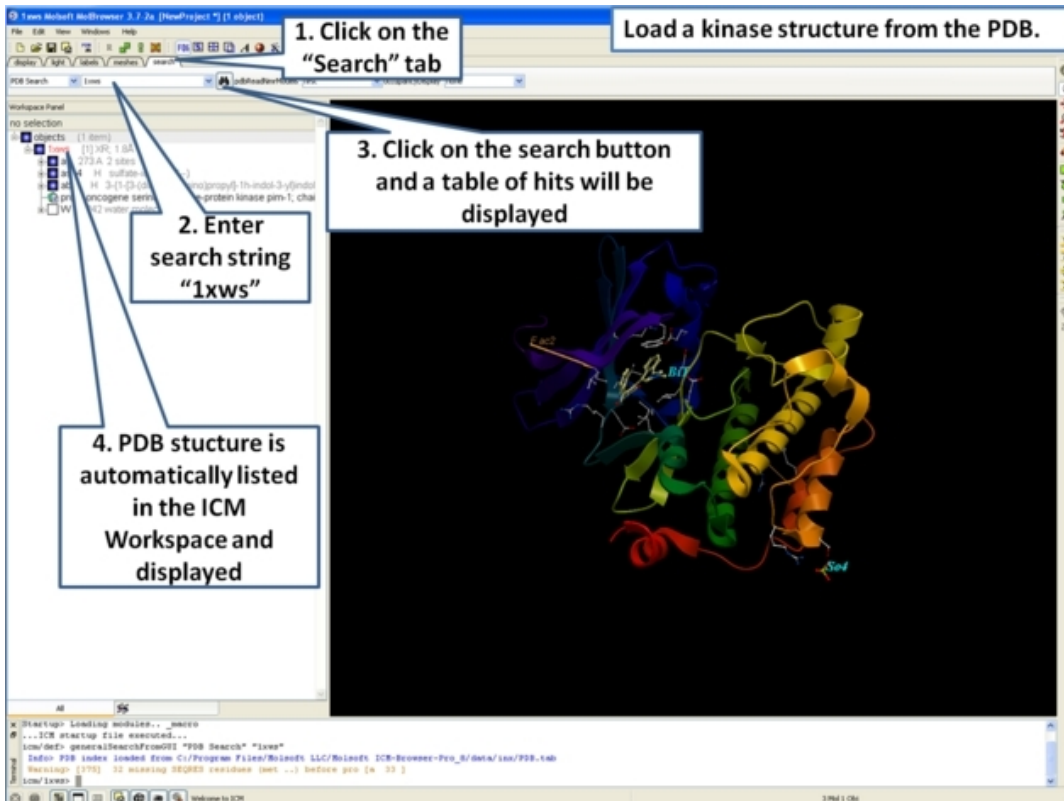

- Next, we will convert the PDB file to an ICM object so we can make slides of the ligand-receptor hydrogen bonds and binding pocket surface.

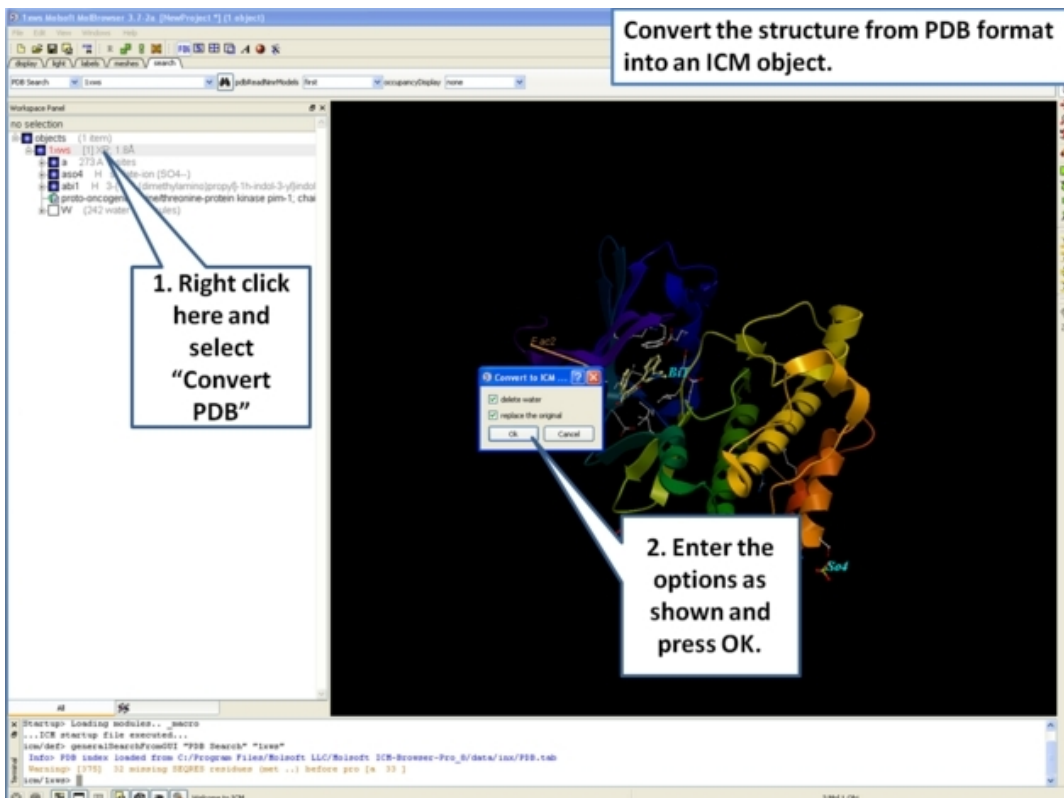

- Now we are going to prepare the first slide by rotating the protein structure to an orientation which allows the viewer to see

the key features of the kinase. For example the bulge in the hinge region (between the N- and C- lobes) which is unique to PIM proteins.

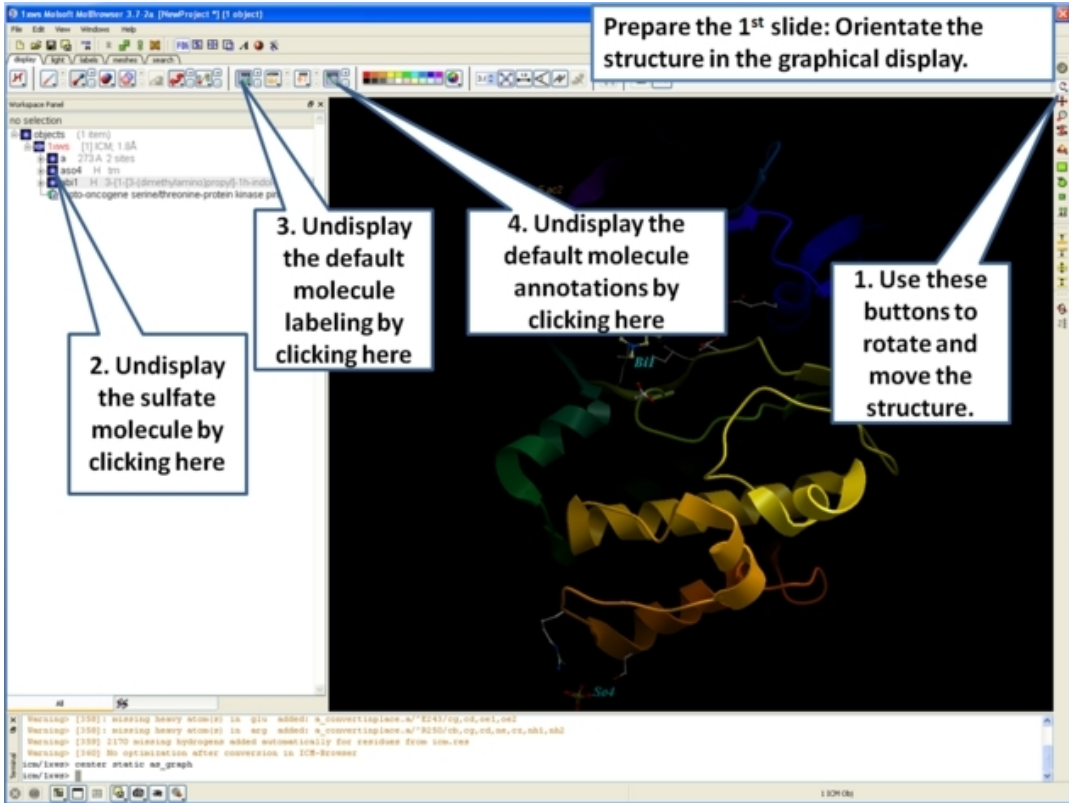

- Next, make the first slide by clicking on the camera button at the bottom of the graphical user interface.

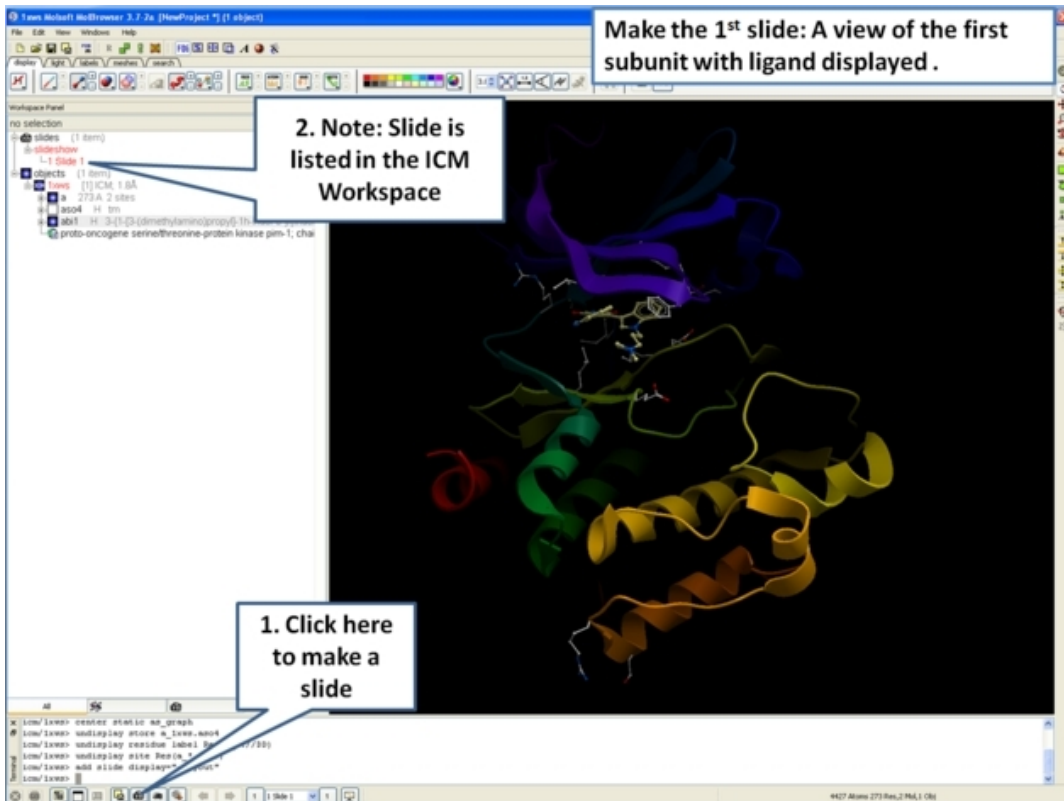

Click to add slide

- Once you have clicked on the camera button you will see that the first slide has been generated. The first slide is shown in the ICM Workspace window as shown below.

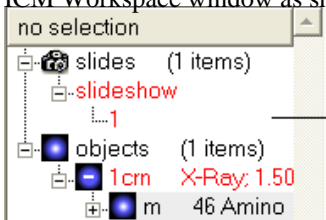

The number and name of the first slide is displayed in the ICM Workspace

- Slides can consist of Static views or Transitions and Animations. Here we will zoom into the flexible glycine rich region of the kinase which lays across the roof of the ATP-binding pocket. Click on the camera button and make the second slide

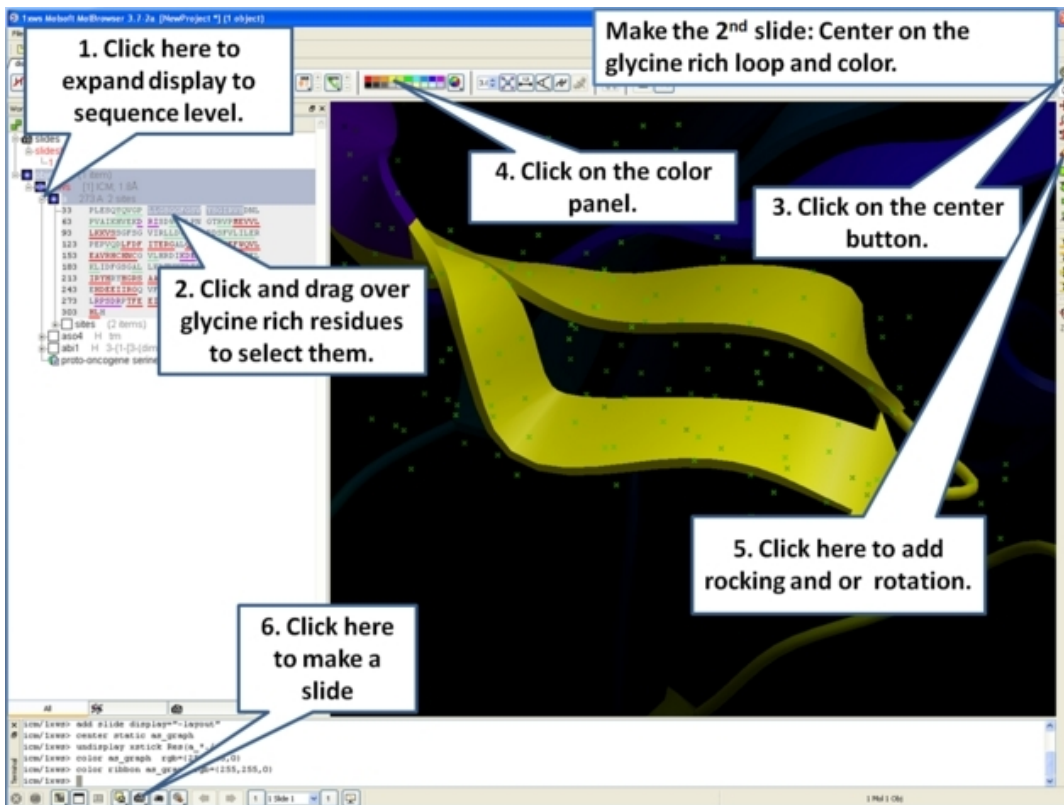

- Next, we will make a slide of the surface of the ligand binding pocket colored by binding property.

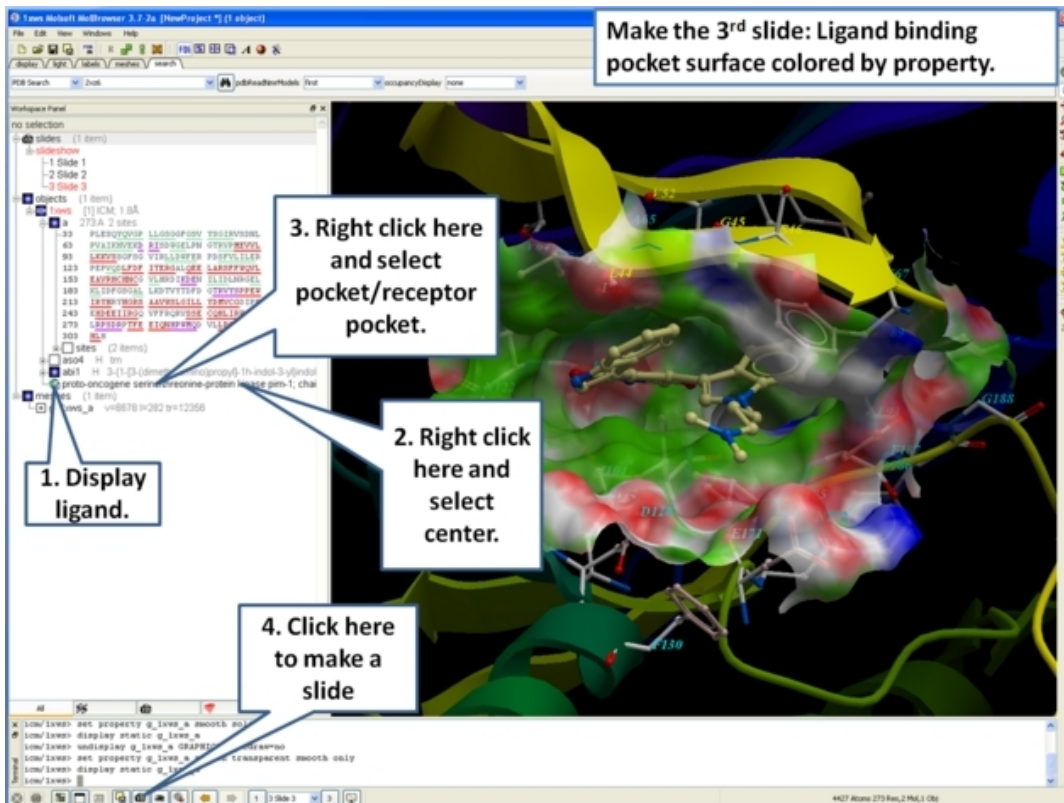

- Now save the document as an icb file. Go to File/Save as...

6.2 Make a Movie from a Set of Slides

Available in the following product(s): ICM-Browser-Pro | ICM-Pro

Please see the movie chapter on how to make a movie from a set of slides.

6.3 How to View and Navigate Slides

Available in the following product(s): ICM-Browser | ICM-Browser-Pro | ICM-Pro

6.3.1 View Slide Show

To view a slide show select the buttons shown below:

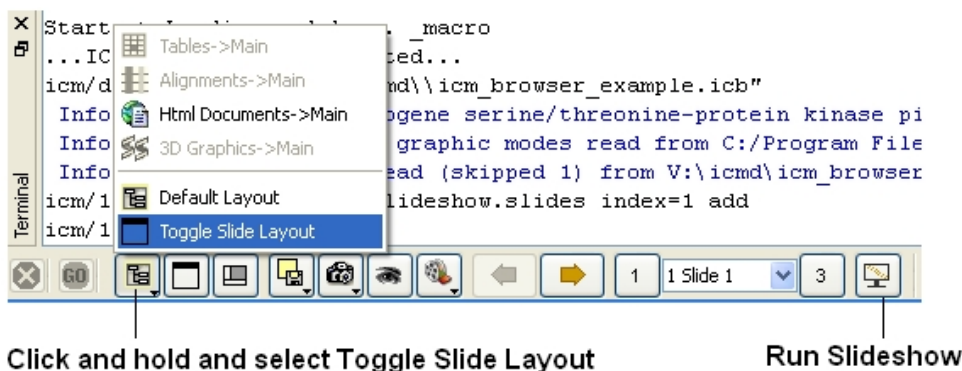

Click and hold and select Toggle Slide Layout

Run Slideshow

NOTE: Slides are associated with the objects currently loaded into ICM. Therefore if you delete an object then the slides will not work. However if you delete an object and then re-read the same object with the same name and structure the slides will be ok.

To save a slide show

- File/Save Project

6.3.2 Slide Navigation

You can make as many slides as you wish as described in the Making Molecular Slides section.

To navigate through the slides you can use the buttons shown below, the cursor keys for some operations or the right click options in the ICM Workspace.

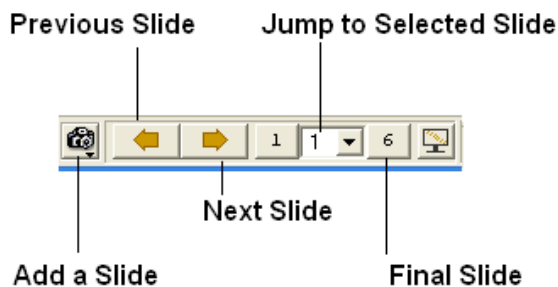

The slide currently displayed is highlighted in red in the ICM Workspace.

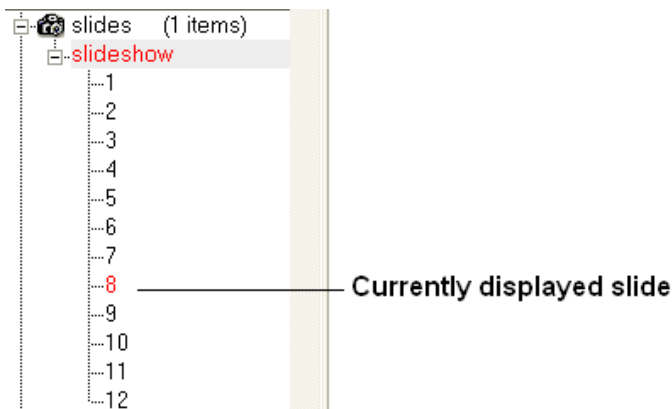

To jump to another slide right click and select "Set Slide".

All slides are displayed in the ICM Workspace. You can hover the mouse over a slide name in the ICM Workspace and a thumbnail sketch of the slide is displayed as shown below. This can be used for slide navigation purposes.

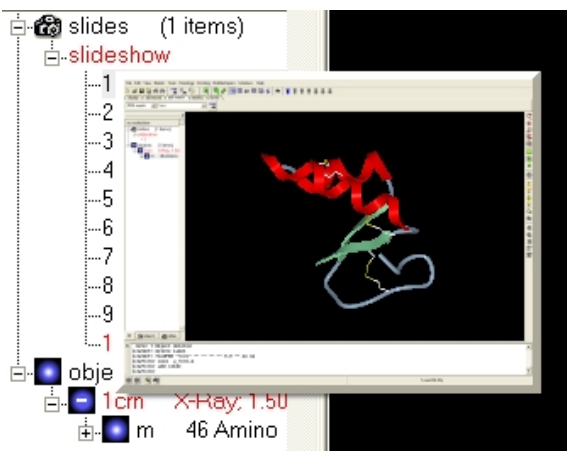

Hover mouse over slide name in the ICM Workspace and a thumbnail sketch of that slide will be displayed.

Or you can right click on the name of the slide in the ICM Workspace and select the option "Preview".

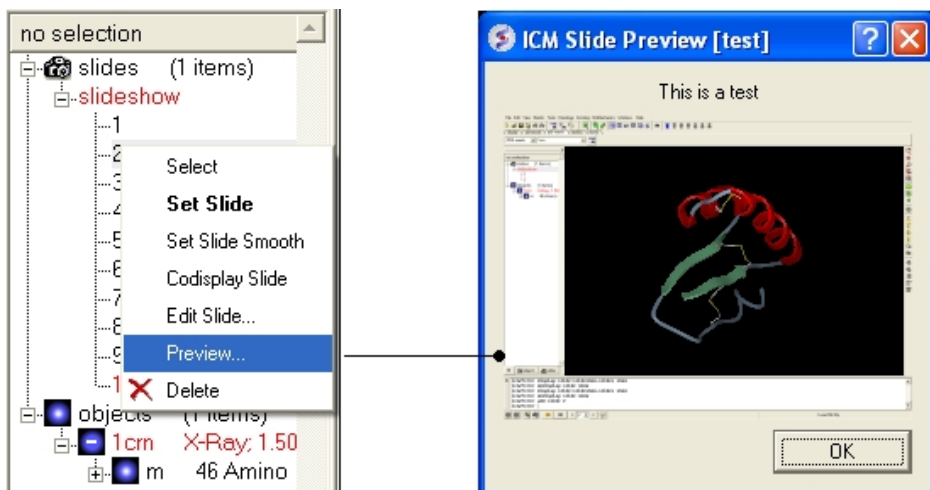

6.4 How to Edit Slides

Available in the following product(s): ICM-Browser | ICM-Browser-Pro | ICM-Pro

You can jump to the slide you wish to edit by following the slide navigation instructions.

6.4.1 Edit Slide

Edit slide contents: To edit the content of a slide the procedure is to add a new slide and then delete the old one or use the "overwrite current slide" option as shown below:

- Click and hold down on the camera button.

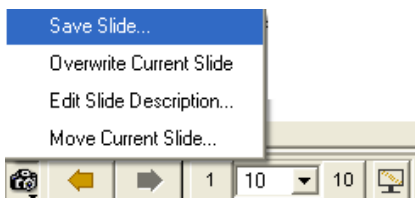

Click and hold

To edit a slide description.

- Click and hold down on the camera button and select the option "Edit Slide Description".

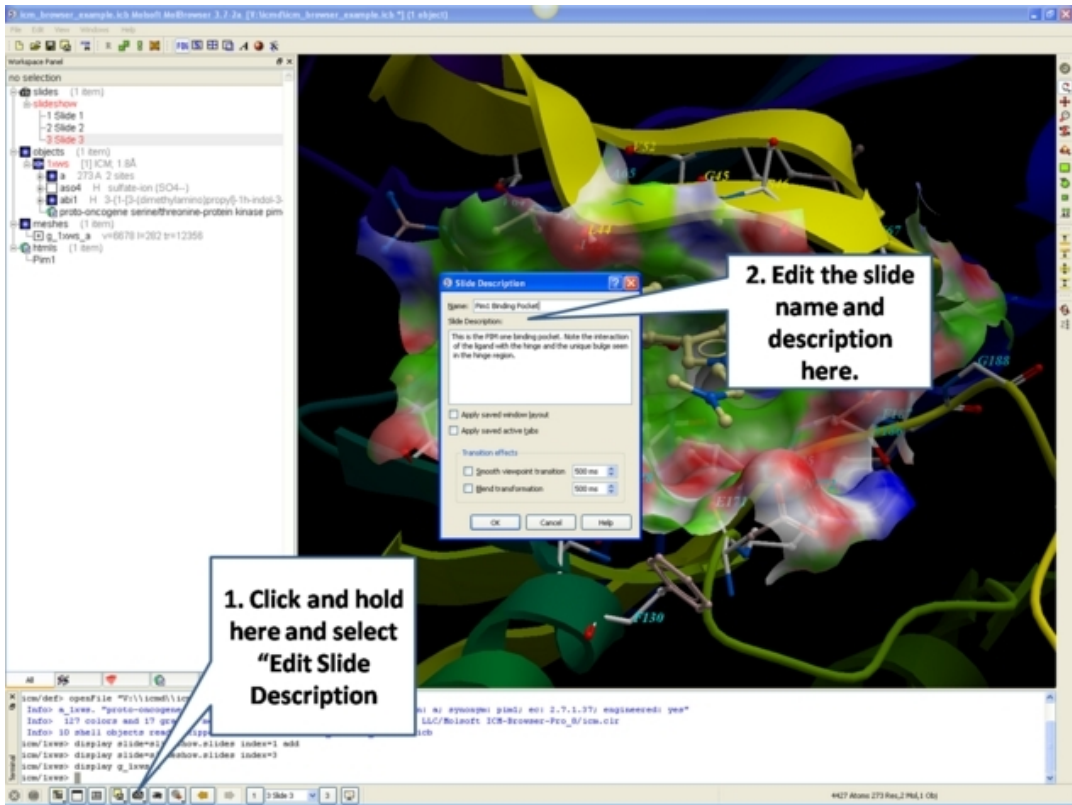

- Enter the name of the slide
- Enter a description of the slide.
- If you wish to keep the current window layout or active tabs check the boxes provided

To delete a slide:

- Right click on the name of the slide in the ICM Workspace and select Delete.

To change the name of a slide

- Right click on the name of the slide in the ICM Workspace and select Edit Slide.

6.4.2 Move Slide

To change the slide's position in the slideshow use the Move Current Slide option and select the new position from the list.

- Click and hold on the "make slide button".
- Select Move Current Slide.

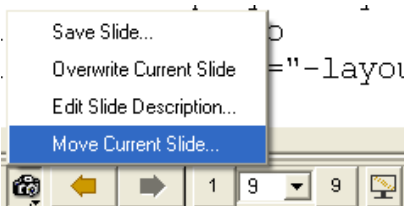

Click and hold

- Select the position in the slide show where you want to move the slide to.

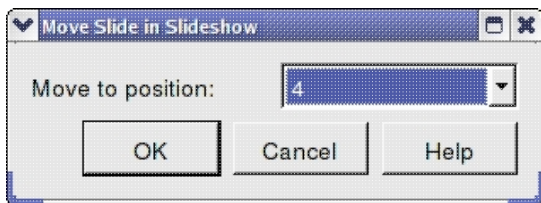

Co-display more than one slide

- Right click on the name of the slide in the ICM Workspace you wish to co-display with the currently displayed slide.
- Select the option co-display slide.

6.5 How to Add Smooth Blending and Transition Effects Between Slides

Available in the following product(s): ICM-Browser | ICM-Browser-Pro | ICM-Pro

How to add smooth and blend transitions to a slide.

- Right click on the name of the slide in the ICM Workspace.
- Select **Edit Slide**.
- Select the desired transition effect - **smooth** or **blend** as shown below.
- Select the length of the transition in milli seconds.

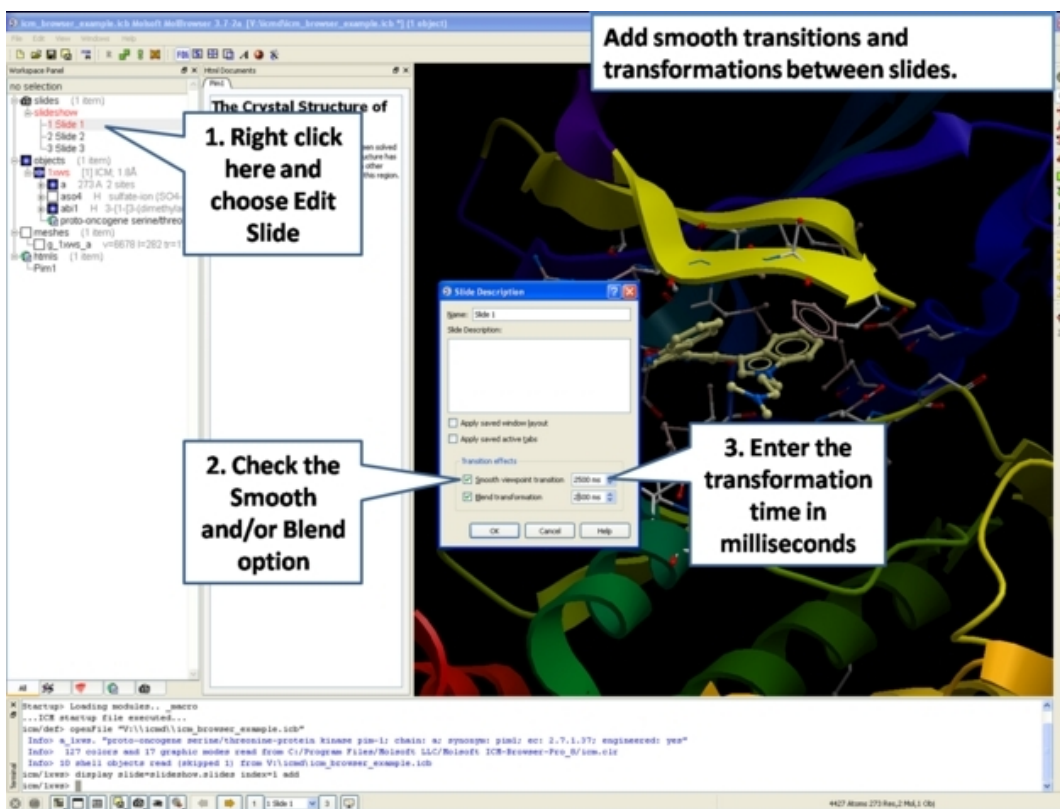

6.6 How to Make Molecular Documents - Link HTML Text to Slides

Available in the following product(s): ICM-Browser | ICM-Browser-Pro | ICM-Pro

An ICM Molecular Document contains text and images which can be hyperlinked to the graphical display. Click on the hyperlinked text and then a fully-interactive 3D slide will be displayed. The hyperlinks are usually linked to a set of slides but can also be linked to a series of commands in a script, a web page, a table or alignment. Once a molecular document has been made you can view it in the ICM-Browser (File/Save Project .icb file) or download ActiveICM and view it in a web page or PowerPoint.

To begin creating an ICM document

- File/New/ and click on the HTML tab.
- Enter some text. E.g the Name of the HTML document. Formatting can be changed as described in the edit section below.
- Click OK

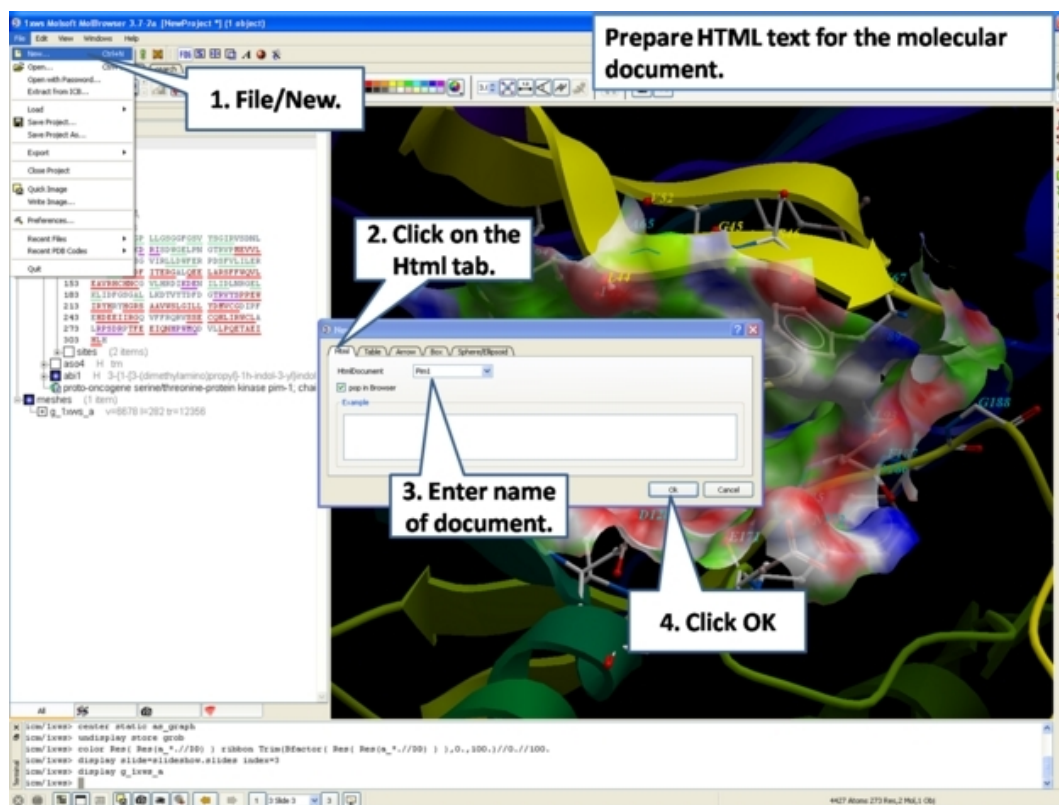

- A HTML text panel will be displayed in the graphical user interface.

NOTE: You can add multiple documents into a single file. The documents will be accessible via tabs at the top of the HTML panel.

6.6.1 How to Add Text or Edit a Molecular Document

To edit the HTML text in the graphical display

- First create an HTML document and the text panel will be displayed in the graphical user interface.
- Right click in the body of the text display panel and select **Edit**.

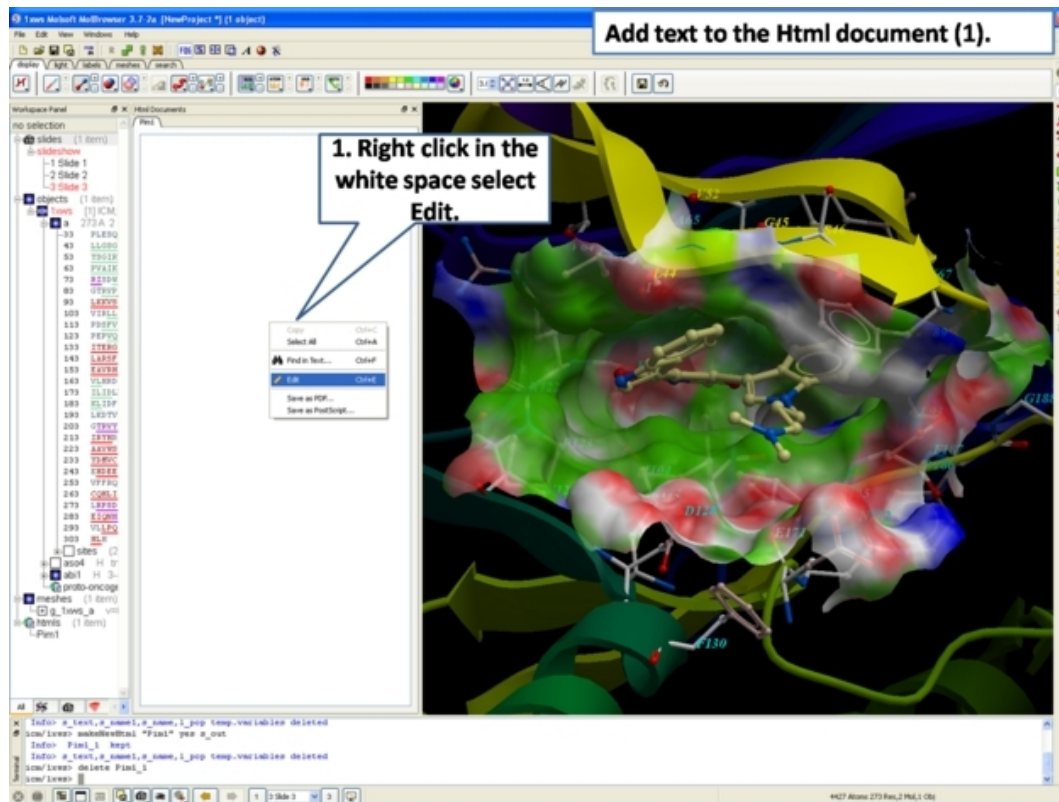

- Enter text and use the formatting tools provided in the panel above the text editor. Make sure you have selected the **Edit** tab in the HTML editor. You can see your page in the **View** tab or write directly in HTML in the **Source** tab.

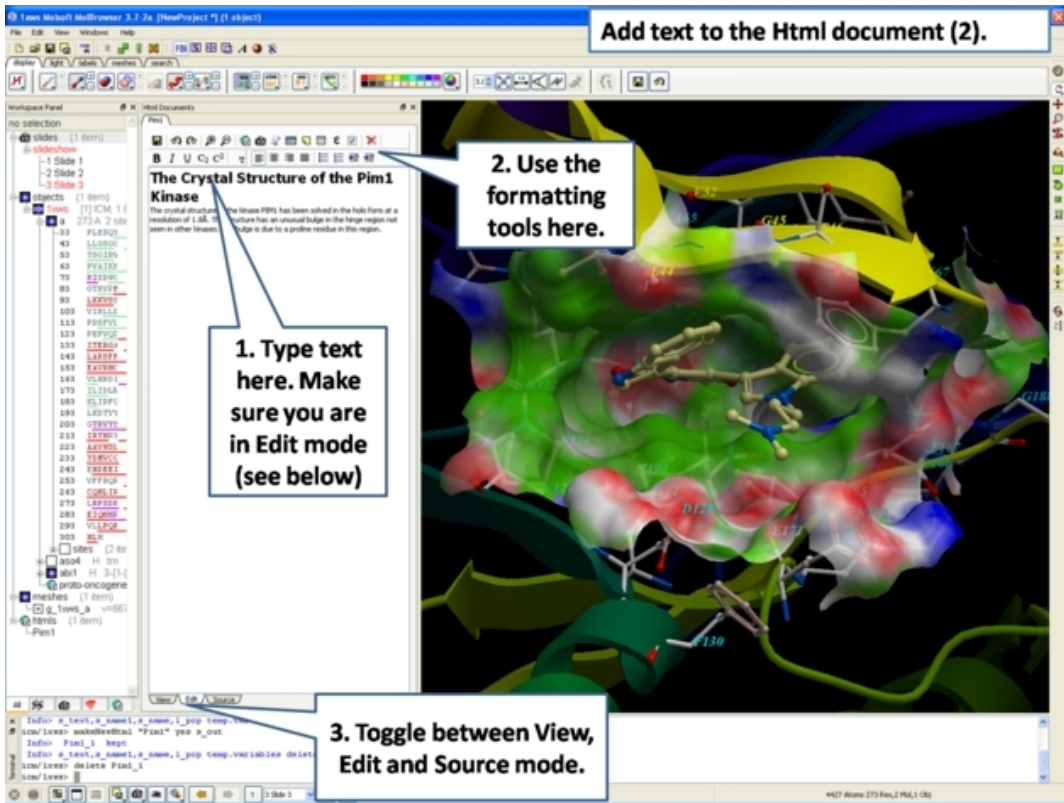

The key formatting tools in the HTML editor are shown below.

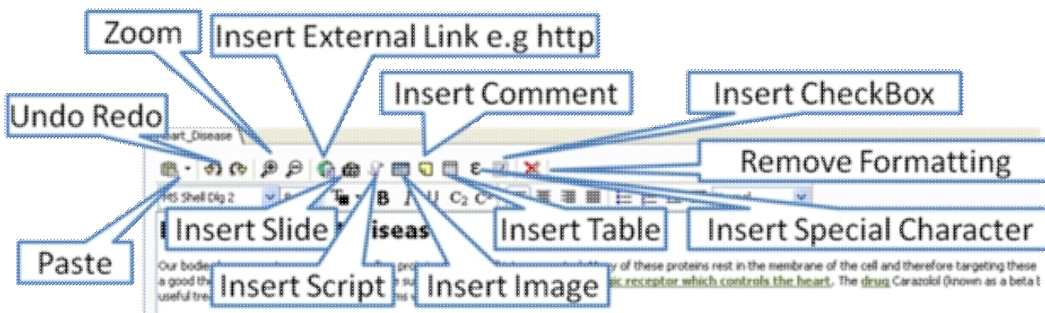

Check appearance using the **View** Tab

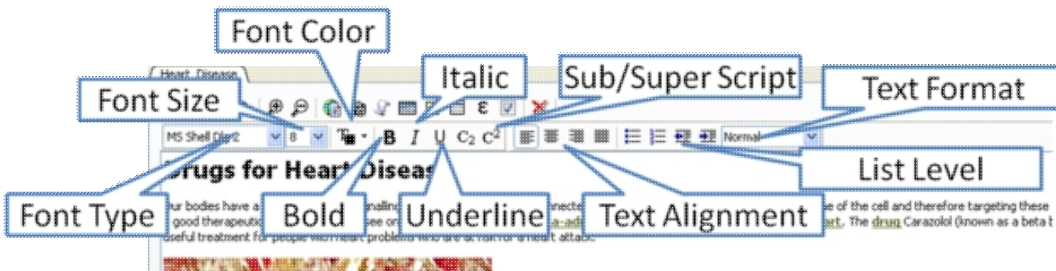
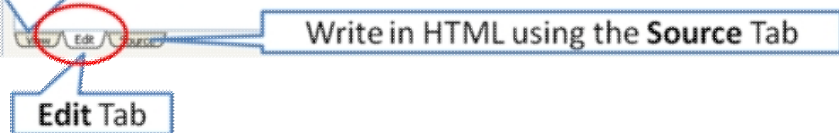

6.6.2 How to Make a Hyperlink Between Text and a Slide

To make a hyperlink between the text and the graphical display (slide)

Make a slide or set of slides of the graphical display you wish to link to. See Making Molecular Slides for help on this. Once slides have been created:

- File/New/Html
- Right click in the body of the text display panel.
- Select Edit.
- Highlight the text you wish to link to a graphical display - you can do this by left clicking and dragging over the text (selected text will be highlighted in blue).
- Click on the "Camera button" in the HTML editor formatting tool panel.
- Select the **Slide** tab.
- Select which number slide you wish the text to be linked to from the drop down menu.
- There is an option to display the slide as a thumbnail image in the text document panel. Check if appropriate.

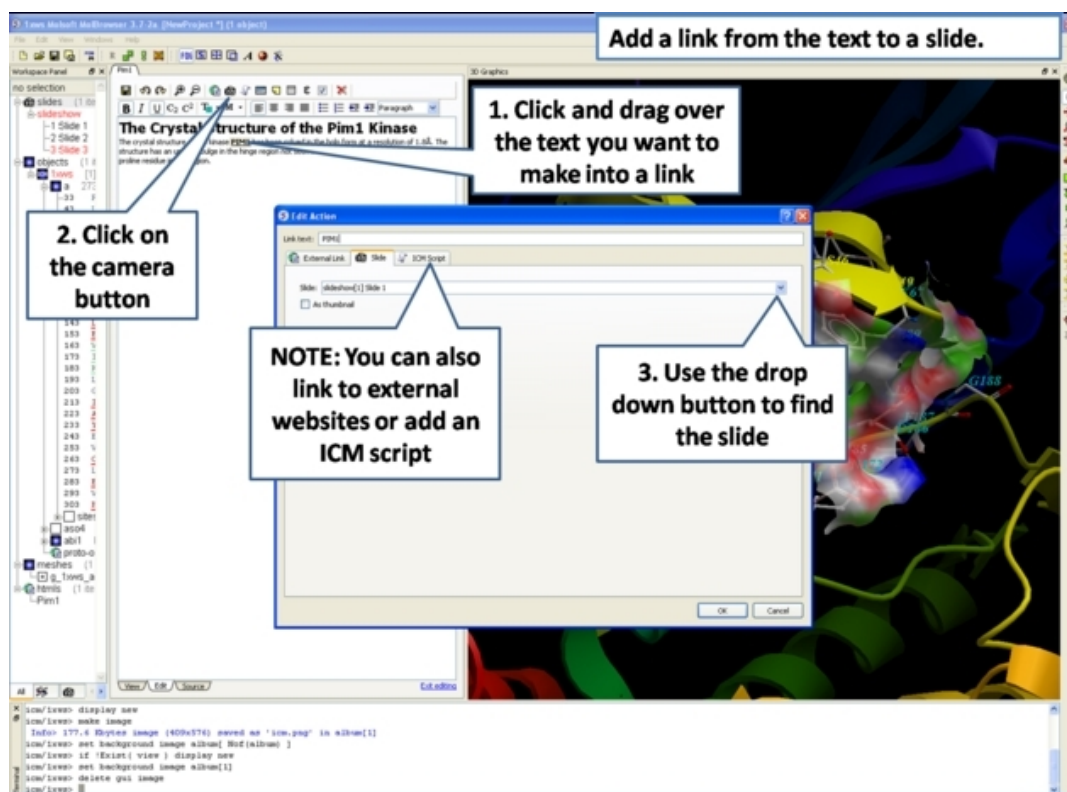

6.6.3 Insert Image

NOTE: The easiest way to add images (PNG or JPEG) into an ICM Document is to use drag and drop. You can drag and drop the image into the ICM Workspace or go to File/Open. Once the image is in the album in the ICM Workspace you can then drag it from the ICM workspace into the HTML editor.

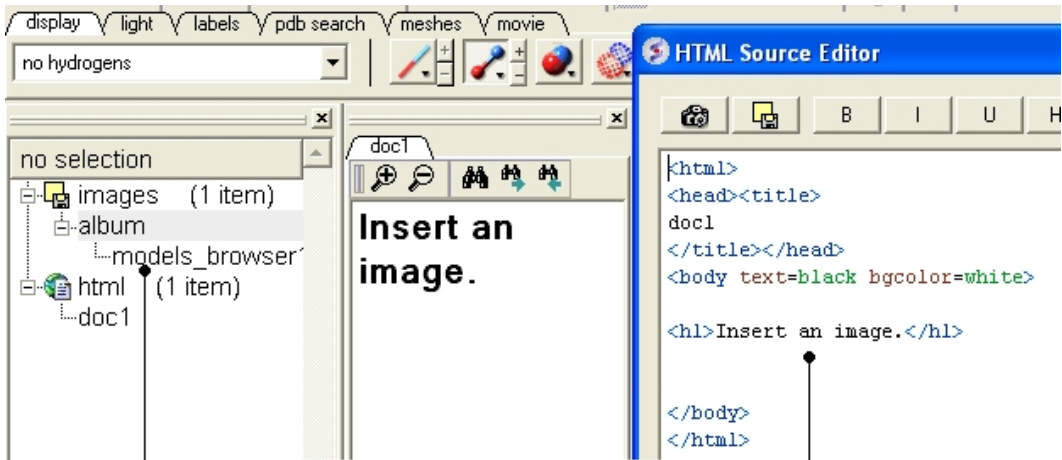

Drag and Drop from the ICM Workspace to the HTML source editor

Another way to insert a picture into the HTML text panel

- First read the image into the ICM photo album File/Open OR Drag and Drop from directory into the ICM Workspace.

The image name and preview will then be displayed in the ICM Workspace.

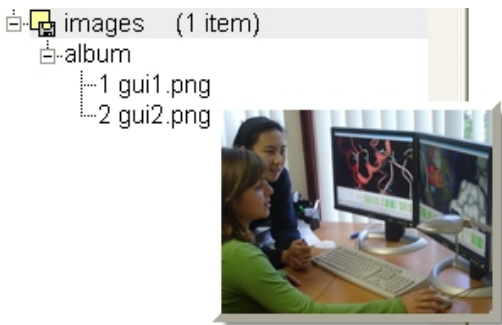

- Create HTML text - File/New/HTML. Add text.
- Right click in the HTML window and select 'Edit Source'.
- Right click on the position in the ICM Script Editor where you would like to insert the image.
- Select 'Insert Image'

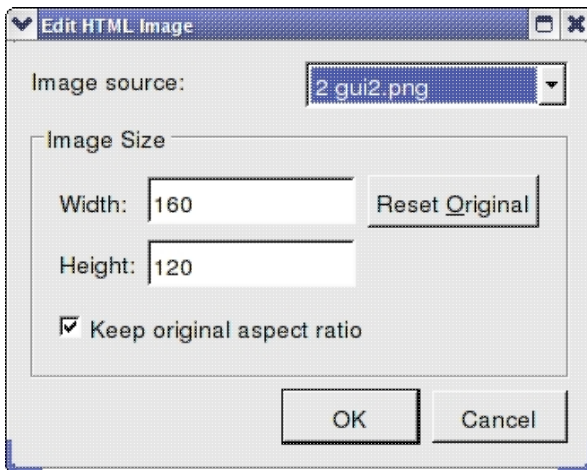

- Select the image name source.
- Choose the desired Width and Height.

- Click OK.
- Click Save in the ICM Script Editor.

6.6.4 Insert Script

How to insert a script to the text panel

There are 3 ways to add a script - described in more detail below

1. Drag and drop script from ICM Workspace
2. In the HTML Source Editor - right click and select Insert Slide or Action
3. Create an "inline" script

These methods are described below:

Drag and Drop Method

- Create a script File/New/Script
- The script will be displayed in the ICM Workspace.
- Right click in the HTML Text Panel (for instructions on how to create this panel see [create molecular document](#)) and select edit source and the HTML Source Editor will be displayed.
- Click-Drag and Drop the script into the HTML Source Editor

A line as shown below will be added.

```
<a href="#icm/script/script1">text placed here will be displayed as a link in the document</a>
```

Another way to add a script to the document is to Insert Action:

- Right click in the body of the text display panel.
- Select Edit Source
- Highlight the text you wish to link to a graphical display - you can do this by left clicking and dragging over the text (selected text will be highlighted in blue).
- Right click and select 'Insert Slide or Action' or select the button in the HTML Source Editor and a window as shown below will be displayed.

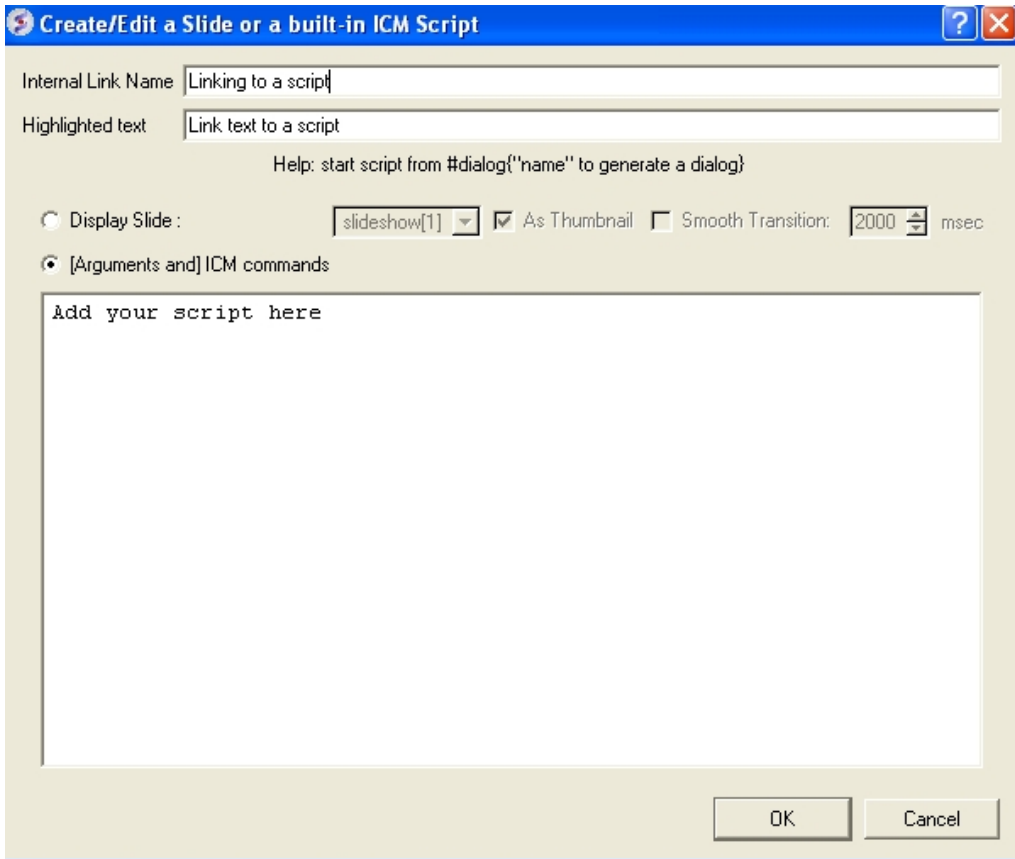

- Select the option [Arguments and] ICM commands
- Add script in the editor provided
- Select ok

Inline Script

A script can be added to the HTML text in the following way

- Right click in the body of the text display panel.
- Select Edit Source
- Enter script in the format as shown below.

```
<!--icmscript name="script2"
#dialog{"Test"}
# i_number1 (2)
# i_number2 (3)
print $1 + $2
--><a name="script2" href="#_">script2</a>
```

6.6.5 Insert a Dialog Box

Dialog boxes are provided to enable a viewer to interact with a presentation or document file. The dialog box will be a gui data entry box. For an example here is a script to prompt the user of the file to enter a pdb code:

```
#dialog{"Read PDB File"}
# s_pdbcode (1crn)
read pdb $1
ds a_1.
```

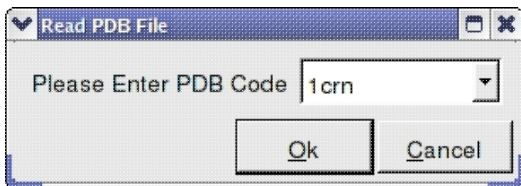

The code above can be saved as a script or inside the html text. To do this:

1. Right click on the HTML text display and select "Edit Source".
2. Highlight the text you wish to link to a dialog box and then select the right click and select 'Insert Slide or Action' or select the button in the HTML Source Editor and a window as shown below will be displayed.

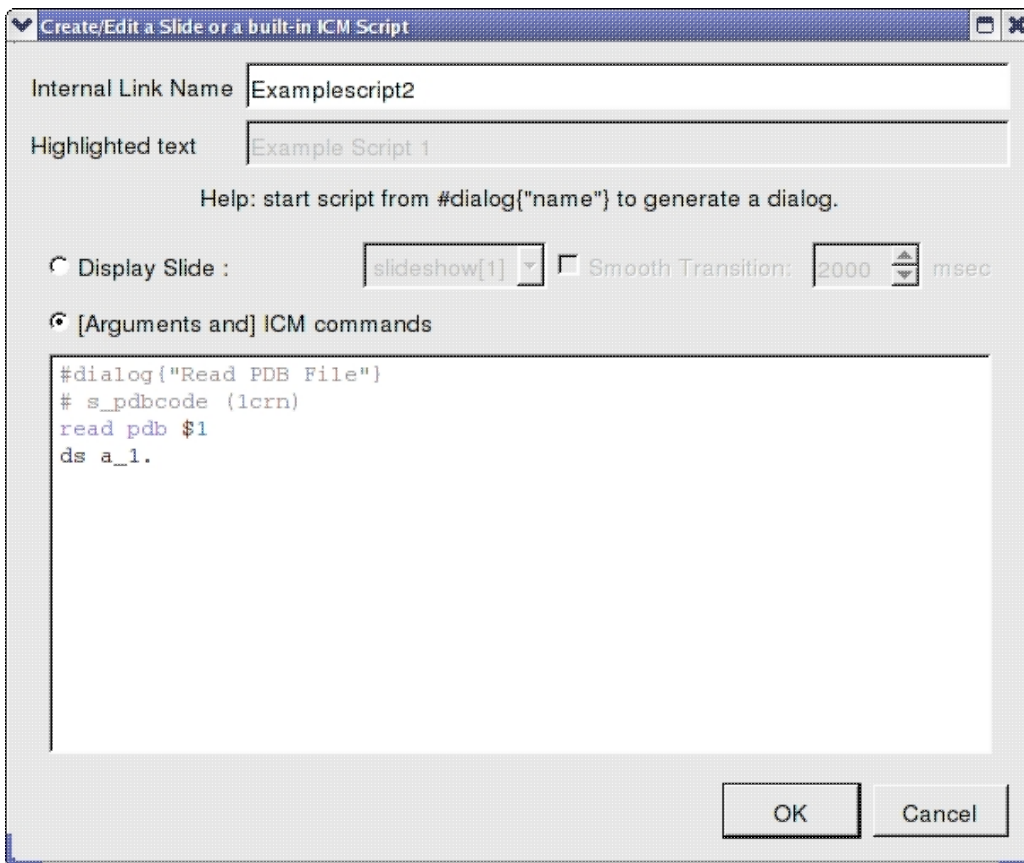

OR.

1. Right click on the HTML text display and select "Edit Source".
2. Add a link to a script as shown below.

```
<a href="#icm/script/script1">Example Script 2</a>
```

6.6.6 How to add a check box.

To add a check box:

- Click on the check box button in the HTML editor tools panel (see below).
- You can choose the check box to toggle an object or molecule on or off. Or you can be more specific about the toggle actions using the ICM command line. You can choose different actions for On and

Off.

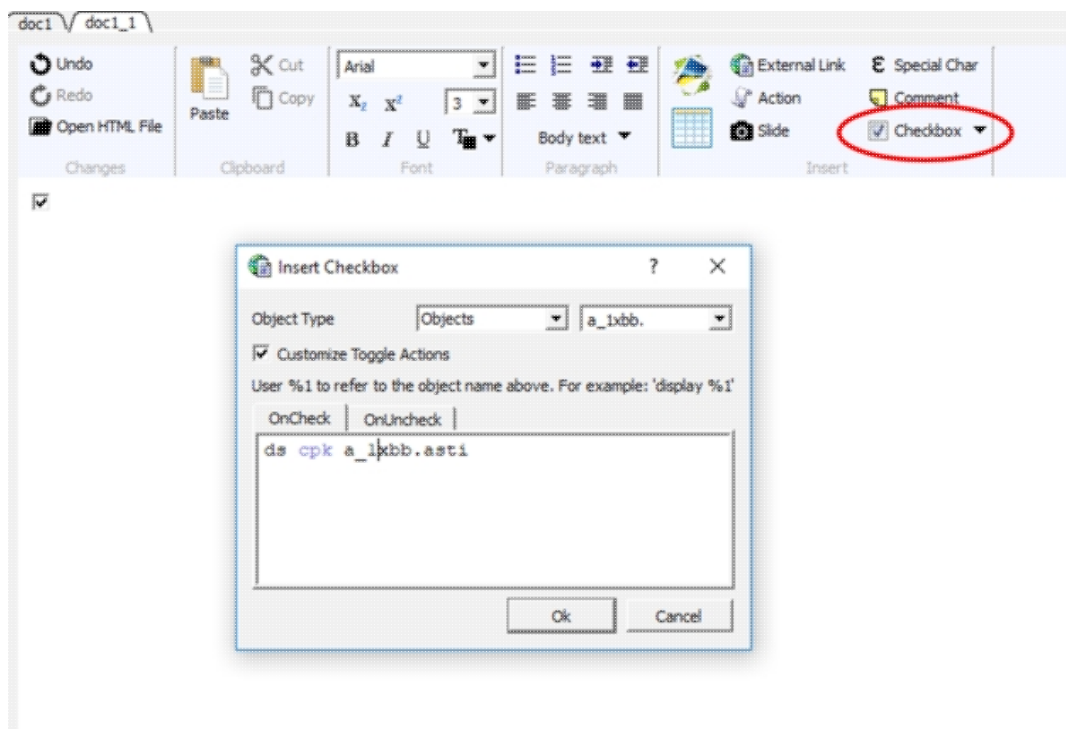

6.6.7 Document Navigation

The following buttons shown below aid document navigation. Also remember that more than one document can be stored and the header of each document file will be displayed in multiple tabs in the text panel window.

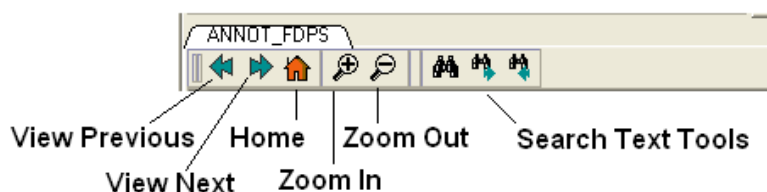

6.6.8 Protect Shell Objects From Deletion

When making a molecular document you can protect objects from deletion by the person who reads your document by:

- Right click on the object in the ICM Workspace.
- Select the **Protect** option.

6.7 ActiveICM

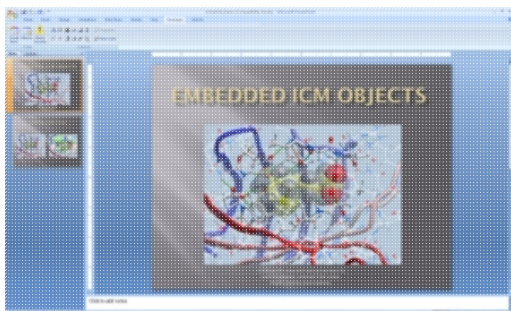

ActiveICM enables you to view and display ICM graphical slides and animations interactively inside Windows Microsoft PowerPoint and web browsers such as Internet Explorer and Mozilla Firefox.

Chapter Contents:

- How to Embed in Microsoft PowerPoint 2003
- How to Embed in Microsoft PowerPoint 2007
- How to Embed in Microsoft PowerPoint 2010
- How to Embed in a Web Browser
- How to Use ActiveICM in PowerPoint
- How to Change ActiveICM Component Properties
- Advanced use of activeICM: Macros to direct visualisation changes
- Background Images

6.8 How to Embed in Microsoft PowerPoint 2003

Setup

- Download ActiveICM from www.molsoft.com/support
- Save an ICM file (.icb) containing slides. Click [here](#) to see how to make slides.

Embed icb file

- Open the Insert menu from the top bar of PowerPoint and select **Object**
- This opens up the Object dialogue. Select **ActiveIcmCtlClass**:

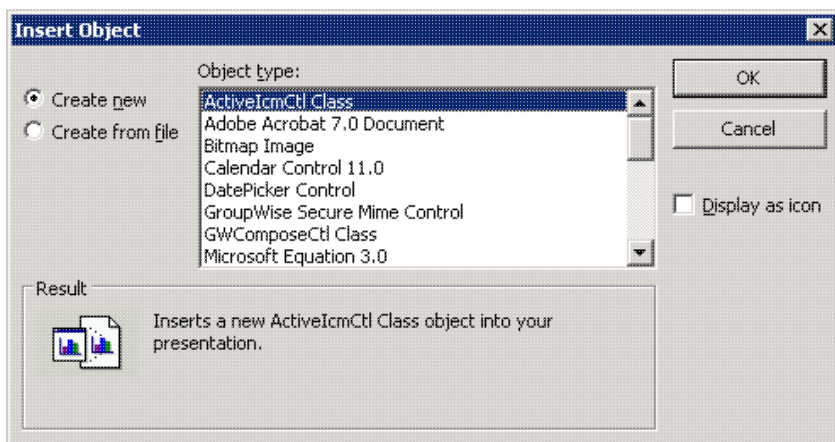

- Click on OK. A file dialogue will then be opened. Open the ICB file you wish to use via this dialogue. **IMPORTANT:** To avoid later problems, make sure the ICB file is in the same folder as the PowerPoint file.
- A low-resolution snapshot of the first slide in the ICB file will be shown in the activeICM control you created. You can change the shape of the control by dragging the corners of the control with

- the mouse, once selected.
- Right-click on the activeICM control and select the Properties menu item

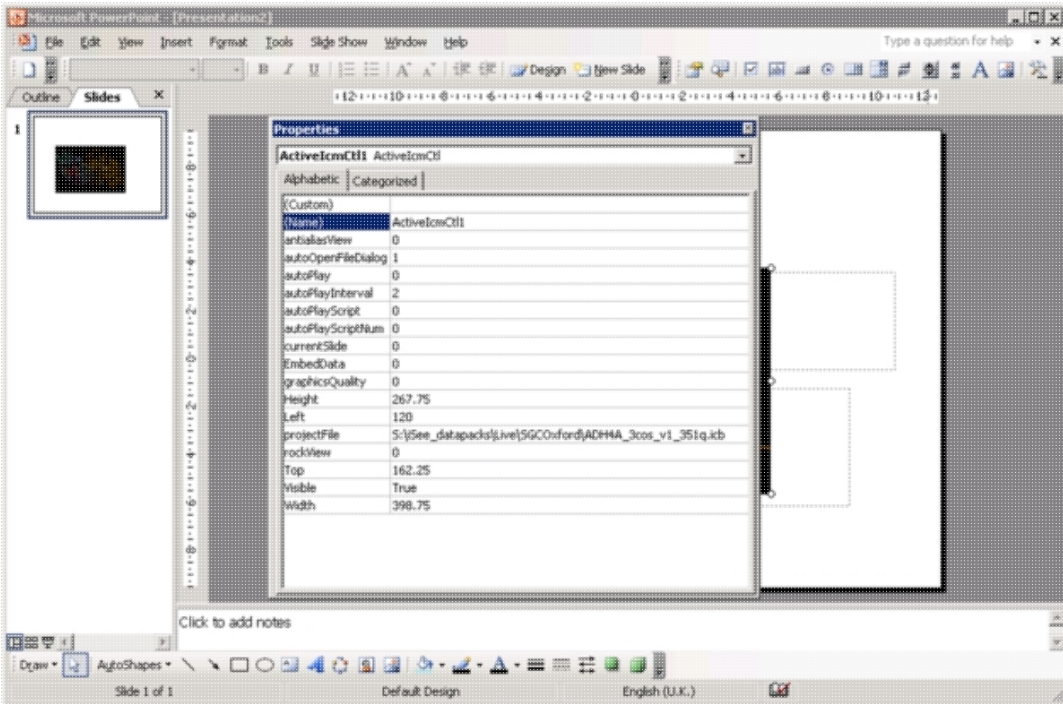

- Save the PowerPoint presentation

6.9 How to Embed in Microsoft PowerPoint 2007

Setup

- Download ActiveICM from www.molsoft.com/support
- Save an ICM file (.icb) containing slides. Click [here](#) to see how to make slides.

NOTE: Here are the instructions for ActiveICM in Microsoft Office 2007, for older versions of PowerPoint see [here](#).

Enable the Developer Menu:

- Click the **Microsoft Office Button** (button top left), and then click **PowerPoint Options**.
- In the **PowerPoint Options** dialog box, click Popular.
- Under **Top options for working with PowerPoint**, select the **Show Developer tab in the Ribbon** check box, and then click **OK**.



Insert ActiveICM into PowerPoint:

- Select the **Developer** menu.
- Select the **More Controls** button in the **Controls** field.
- Select **ActiveICMctl Class** from the list of controls and click **OK**.
- Click the mouse anywhere in the white PowerPoint space and a dialog box will be displayed asking you to select your ICM (.icb) file.
- Click and drag at the corners of the image to resize the normal way you would resize an object in PowerPoint.

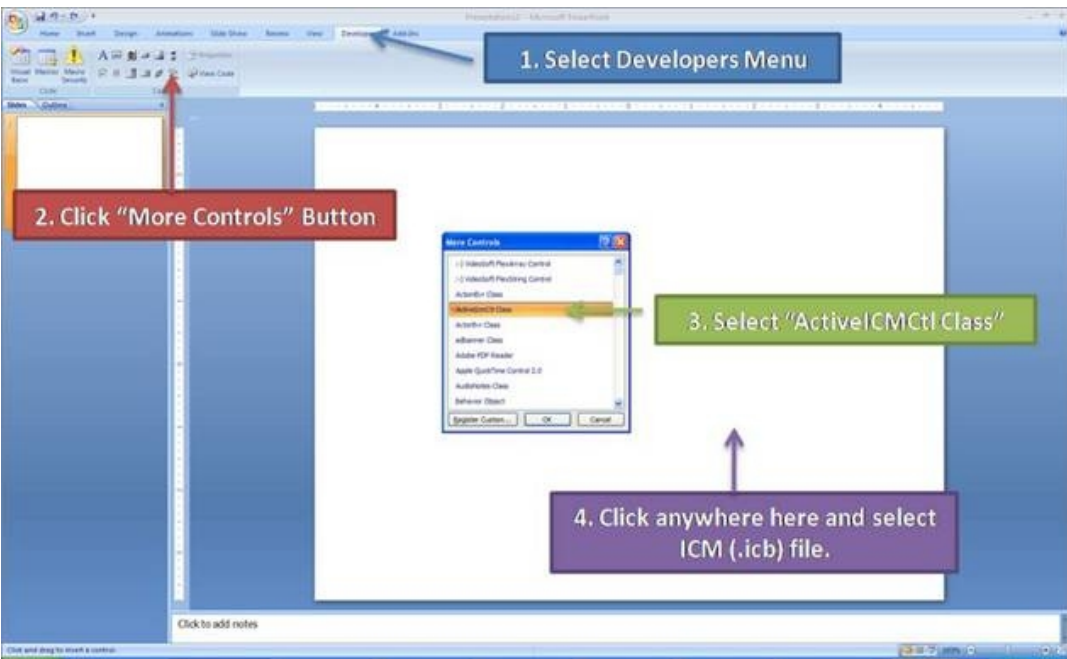

6.10 How to Embed in Microsoft PowerPoint 2010

Setup

- Download ActiveICM from www.molsoft.com/support . Please always check you are using the latest version.
- Save an ICM file (.icb) containing slides. Click [here](#) to see how to make slides.

Enable the Developer Menu:

- Click on the File tab, and then click Options menu.
- Select the **Customize Ribbon** option and then check the **Developer** option in the right hand side panel (see image below).
- Click on the **Developer Menu**.
- **IMPORTANT!** Click OK and then you will see the Developer Menu in the Ribbon at the top of PowerPoint.
- Select the Developer menu.
- Select the **More Controls** button in the **Controls** field.
- Select **ActiveICMctl Class** from the list of controls and click **OK**.
- Click the mouse anywhere in the white PowerPoint space and a dialog box will be displayed asking you to select your ICM (.icb) file.
- Click and drag at the corners of the image to resize the normal way you would resize an object in PowerPoint.

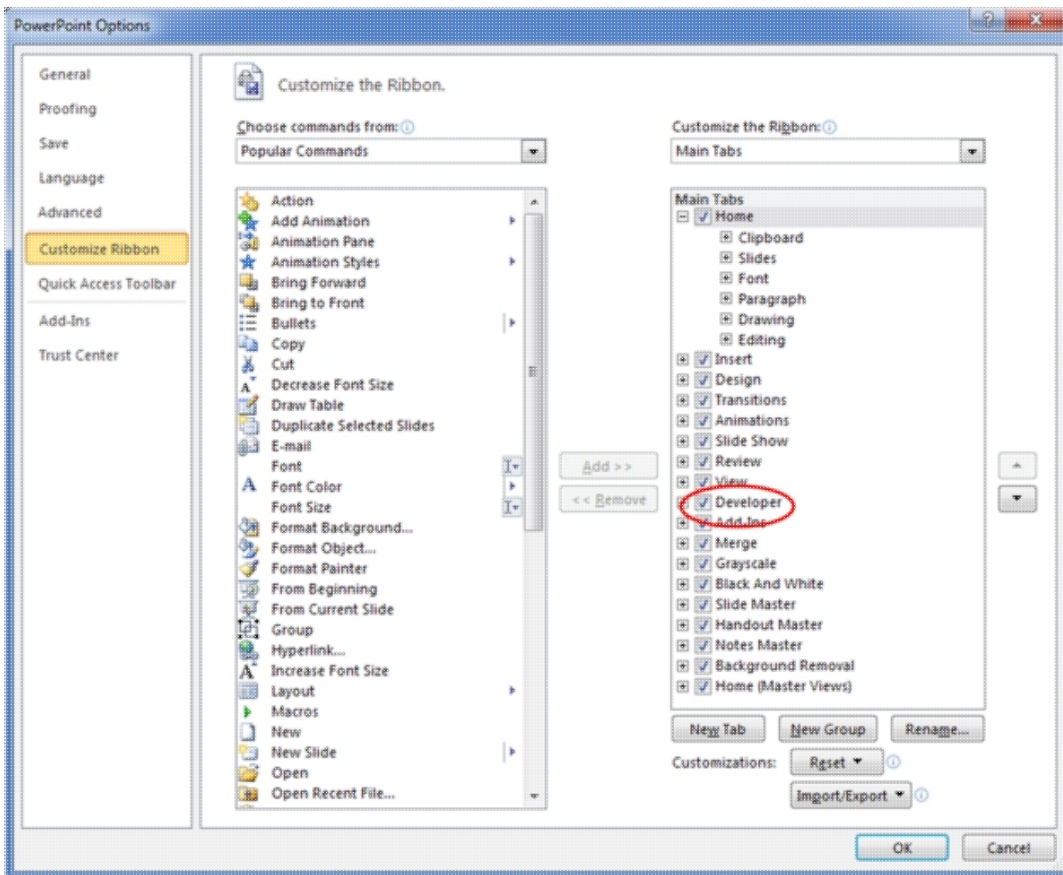

6.11 Embed in Web Browser

NOTE: There is now a plugin-free version using JavaScript/HTML5 - click [here](#) for more information.

To embed in a web browser.

1. Download ActiveICM from [here](http://www.molsoft.com/getbrowser.cgi?product=activeicm&act=list)
<http://www.molsoft.com/getbrowser.cgi?product=activeicm&act=list>
 (it is free!).

2. Create an HTML page in ICM (File/New/Html).
3. Add a series of slides.
4. File/Export As ActiveICM Html..

NOTE. There is an issue with FireFox21 because it disables the ActiveICM plugin. The workaround at the moment is:

- type about:config in the location (address) bar and press the "Enter" key to open the about:config page, just like you open a website by typing the URL in the location bar.
- if you see a warning message then you can confirm that you want to access the about:config page.
- in the Search bar at the top of the about:config page type 'load_appdir_plugins'
- double click on the preference to set value to true
- restart FF

6.12 How to Use ActiveICM in PowerPoint

****IMPORTANT There are two ways to open a presentation:**

- Double click on the ppt file in windows folder. (in this case PowerPoint will set the current directory to the one which contains the file and there should be no problems with both relative and absolute paths)
- Open ppt through the "File-Open" or recent files. (in this case PowerPoint DOES NOT SET the current directory to the one which contains the file -> relative path might not work and user will be prompted to locate the ICB file unless file is found in absolute location)

To view the slides you must be in Slide Show mode

- Press the **F5** button to start the **Slide Show**. In edit mode (i.e. not presentation mode), the control is shown as a static image  it is not possible to interact with the ICB file. Therefore, to prepare the presentation so that the control shows the correct initial visualisations it is necessary to run the PowerPoint slide(s) in presentation mode

Change Slides

- Use the left and right cursor keys to change slides.

A number of other options can be accessed by right clicking on the slide. These options include:

- Select Slide
- Auto Play
- Set on/off rocking
- Center
- Load a new ICM File

ICM Embedded Into PowerPoint in Slide Show Mode (F5 button)

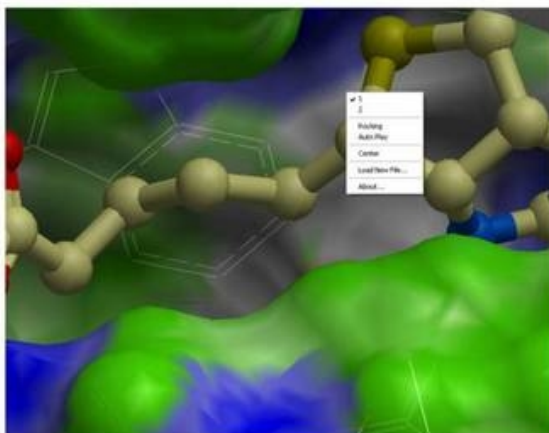

You can also add multiple ActiveICM 3D displays in one slide:

- To display multiple ActiveICM 3D displays in one slide just copy the original display or repeat the steps described above. All powerpoint slides should point to the same ICM file (.icb) but they can point to different slides.

Side-by-side view

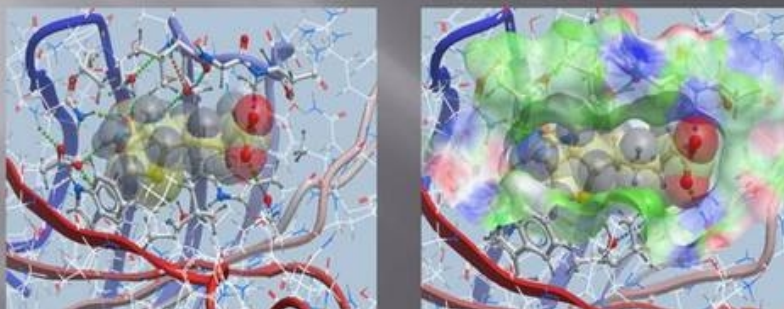

6.13 How to Change ActiveICM Component Properties

A number of properties of ActiveICM can be changed once embedded in powerpoint. The options include:

- Select the first slide to be displayed.
- Set slide auto play.
- Set auto play of a script.
- Embed the powerpoint file and the icb file all into one file.

To change these options:

- Right click on your embedded activeICM in Powerpoint.
- Select **Properties** and click on the button shown below.

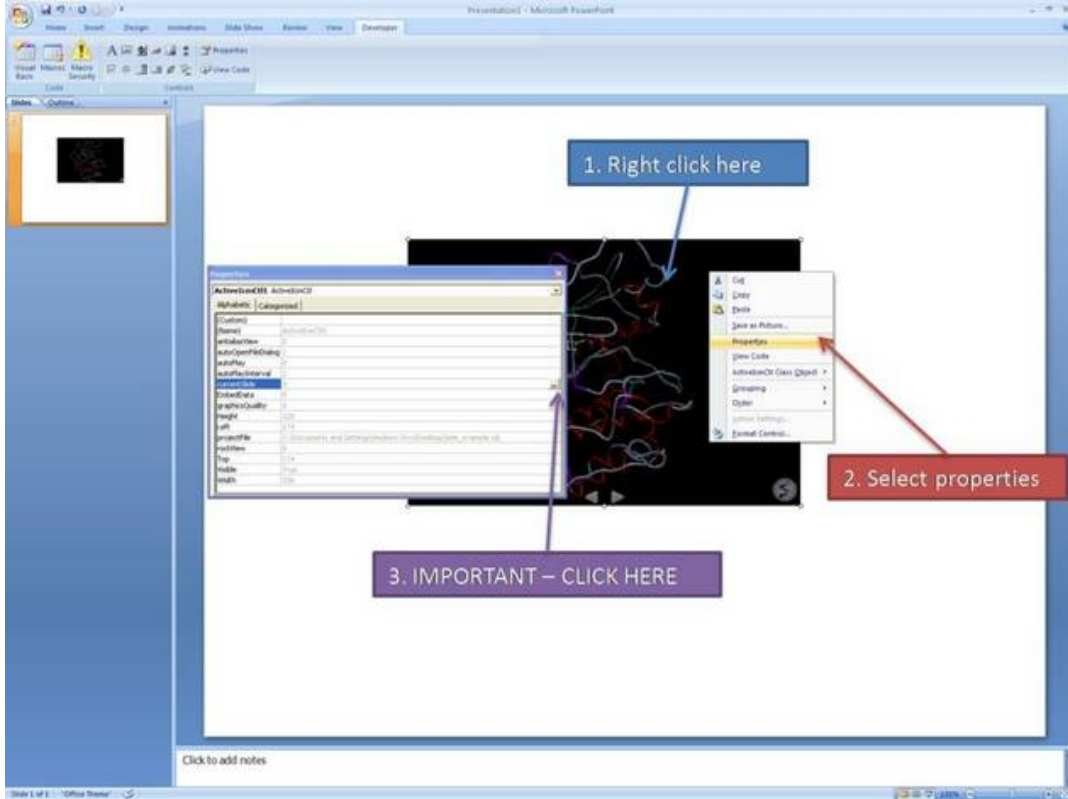

- A **Property Pages** window will then be displayed as shown below.

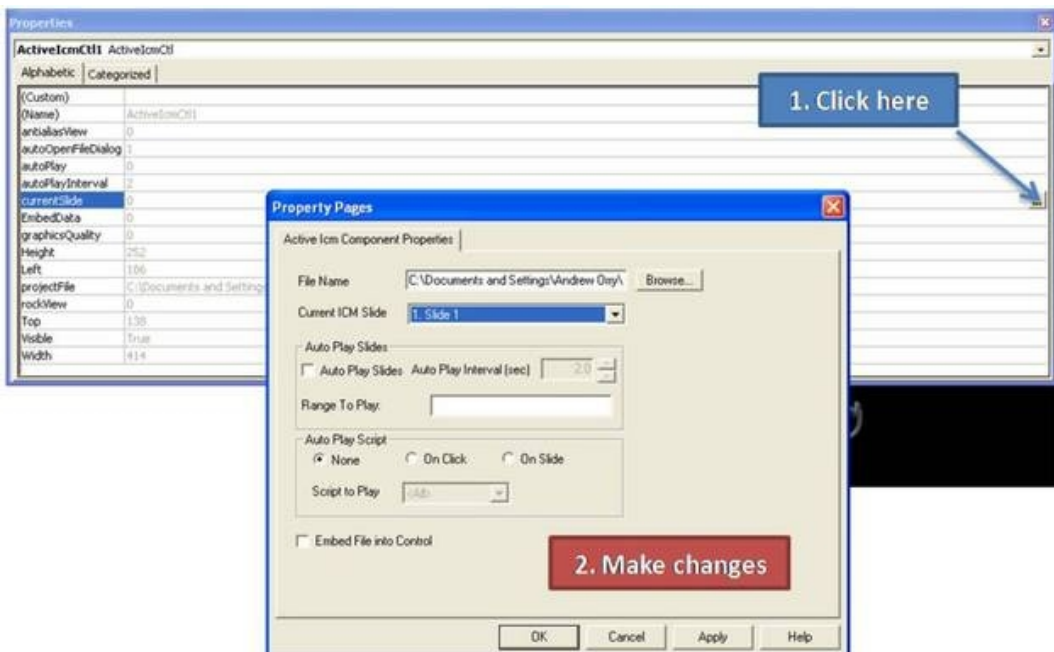

To change the file name of the icb file linked to activeICM: Simply type in the path to the file or use the browse option.

To change the current ICM slide: Use the drop down button next to **Current ICM Slide** to select the slide you wish to display first in your presentation.

To auto play slides: Check the **Auto Play Slides** box and select the interval between slides option. A range of slides can be played by entering the number of the slides separated by a comma.

To auto play a script: Select whether you want the script to run **On Click** or **On Slide** then select the script from the **script to play** drop down button. You should first save your script in the icb file.

To embed the icb file in the ppt file Click the **Embed File into Control** option. **Important** - Please save your PowerPoint file in the t 1997-2003 ppt format not pptx.

6.14 Advanced use of activeICM: Macros to direct visualisation changes

Documentation kindly provided by Dr. Brian Marsden (SGC Oxford
<http://www.sgc.ox.ac.uk/people/brian/>)

It is possible to write simple VisualBasic scripts to avoid having to use the right-click menu approach to changing activeICM control slides within the control itself. This allows one to place buttons outside of the activeICM control, but in the same PowerPoint slide, which controls the control's behaviour. Below are a couple of useful examples of this approach.

Creating a button to set the control's active slide:

Insert a button Office 2003

- In edit mode, make sure the control toolbox toolbar is shown by right-clicking the blank area at the top of the top bar and ensuring **Control Toolbox** is ticked.

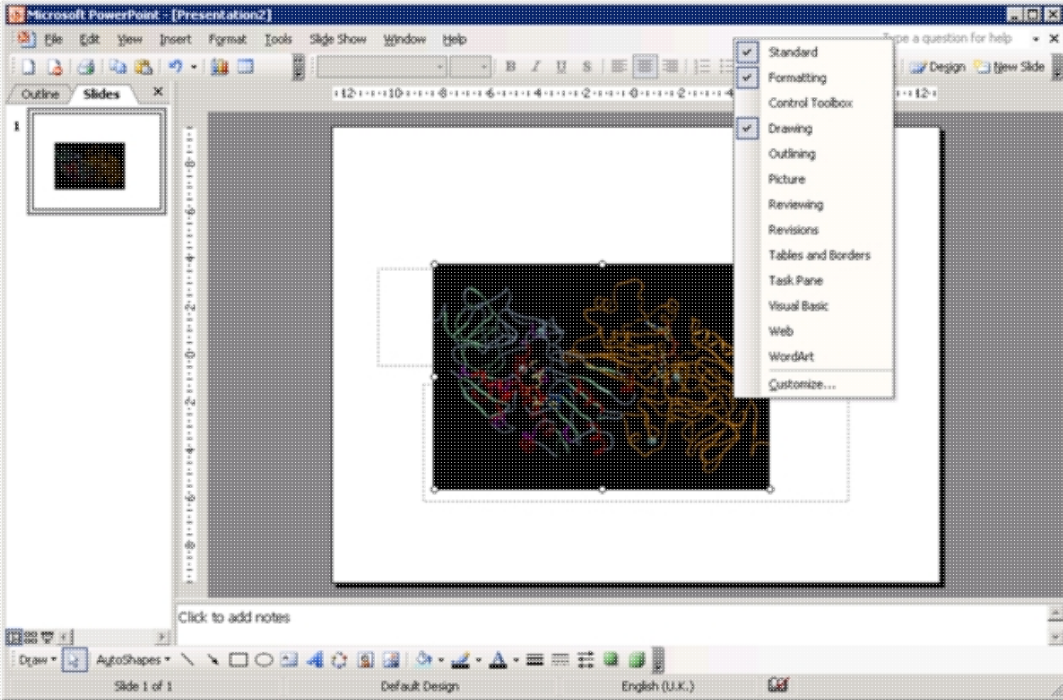

- Click on an icon in the Control Toolbox which corresponds to the sort of button you wish to use. Then click and drag in the PowerPoint slide to generate the button.

Insert a button Office 2007:

- In edit mode, click on an icon in the Developer menu or ribbon which corresponds to the sort of button you wish to use. Then click and drag in the PowerPoint slide to generate the button.

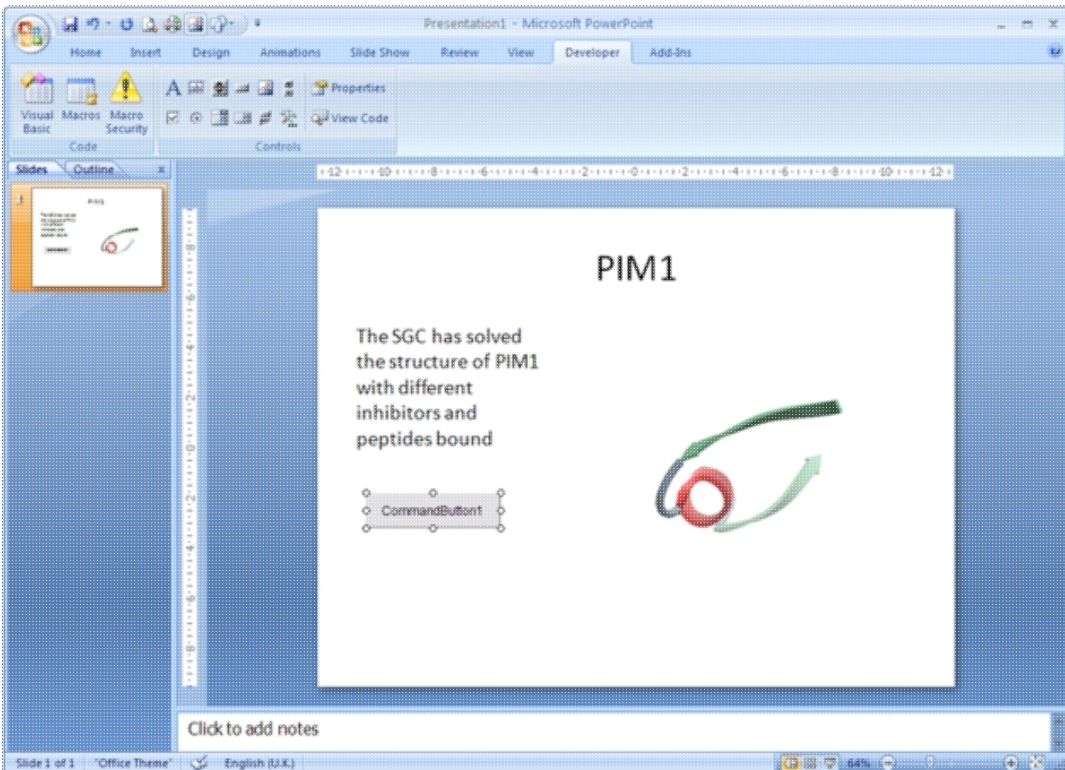

- Double-click on the new button to open the VisualBasic editor with two empty functions pre-defined. The first one pertains to the control itself and can be ignored in this context *For the second function (which is for the newly-created button), copy the following into the editor, between the two lines of function code:

```
ActiveIcmCtl1.currentSlide = 2
```

- This sets the current activeICM control's slide to be number 3 **note** that the value placed in this code needs to be 1 less than the actual slide number (confusing, no?). Obviously, use a value here that makes sense in the context of your ICB file.
- This should leave the editor looking like this:

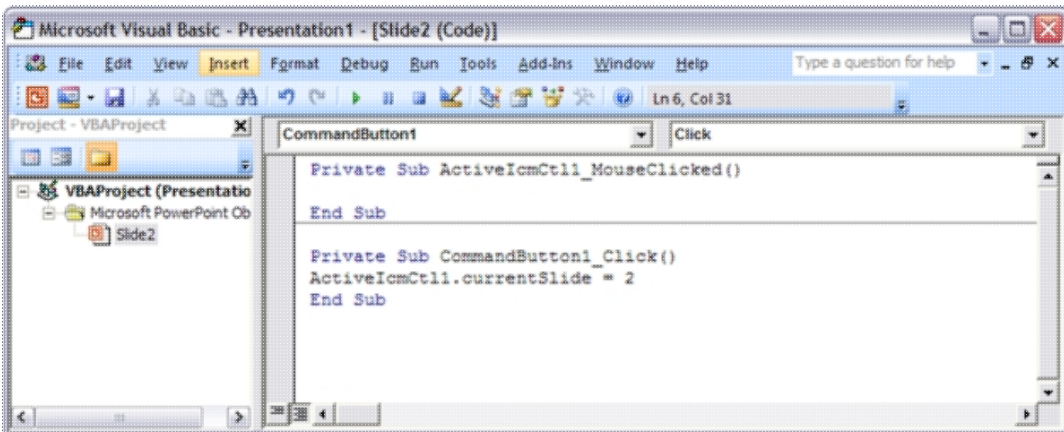

- Close the Visual Basic editor
- To change the physical properties of the button e.g. text, colour e.t.c.right-click on the button and select the Properties menu option. This opens up a dialogue as below, where many properties of the button can be changed:

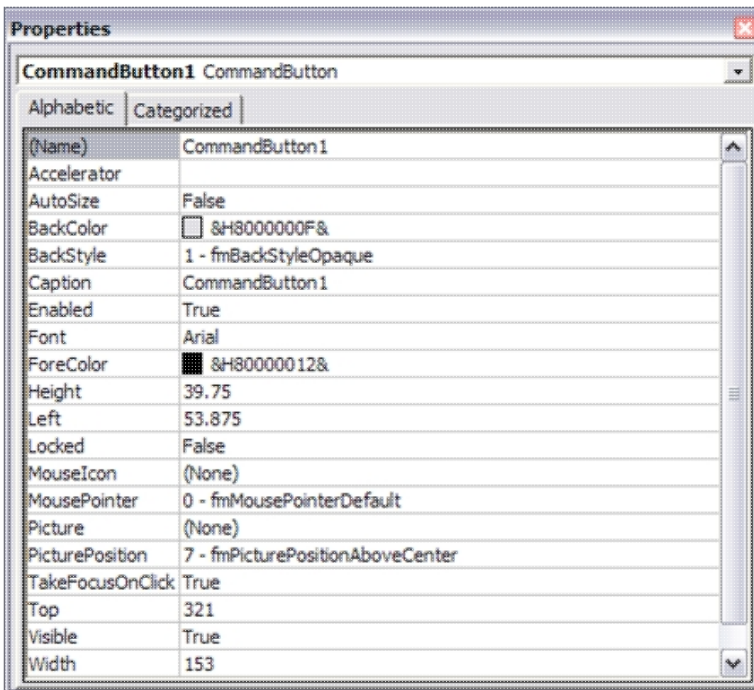

- Using this dialogue, it should be possible to disguise the button to look like normal text (for example) which can be clicked on during the presentation to change the visualisation of the

control, apparently magically. Note that the button will only work in presentation mode.

- **IMPORTANT:** In Office 2007, remember to save the PowerPoint presentation now as a pptm file that is, a macro-enabled PowerPoint file otherwise the macros will not work next time you load the presentation.

Other code examples: Just copy and paste the example of interest inside the function for the button in the Visual Basic editor. Code that enables a button to cycle through the ICB files slides in order (including wrap-around)

```
currentSlide = ActiveIcmCtl1.currentSlide
numSlides = ActiveIcmCtl1.nofSlides
If currentSlide = numSlides - 1 Then
ActiveIcmCtl1.currentSlide = 0
Else
ActiveIcmCtl1.currentSlide = currentSlide + 1
End If
```

6.14.1 PowerPoint Cache Errors

PowerPoint caches some information about active controls. Sometimes after an ActiveICM upgrade you may get an error when trying to access some property or method: "Wrong number of arguments or invalid property assignment" or something similar.

In this case you need to close PowerPoint and remove all files from the location below:

C:\Documents and Settings\seva\Local Settings\Temp\PPT11.0

6.15 Background Images

In ActiveICM version 1.1-5 and higher you can add background images to your icb file and display in PowerPoint and the web using ActiveICM. The documentation on how to insert background images can be found [here](#).

6.16 ICM JavaScript (IcmJS)

IcmJS (formerly known as ActiveIcmJS) is a JavaScript/HTML5 version of the ActiveICM plugin. You can read more about IcmJS [here](#).

To make a fully interactive 3D molecular web page from ICM and embed using IcmJS:

- Use ICM version 3.8-5 or higher. If you do not have access to this please contact MolSoft to request it.
- Make a set of slides.
- Go to File/Export as ActiveICM Html and then select the IcmJS check box.
- The IcmJS file will then be saved to your computer which you can open in any modern browser e.g. Chrome, FireFox or Safari.

7 Cheminformatics

Chapter Contents:

- Read Chemical Format Files
- Save Chemical Structures and Images
- Chemical Spreadsheets (Chemical Tables)
- Sketch Chemicals - Molecular Editor
- Chemical Search
- Convert Chemicals to 3D
- ToxScore
- Generate Chemical Fragments
- Find Bioisostere
- MolCart - Chemical Cartridge
- Calculate Properties
- Standardize Table
- Annotate Chemical by Substructure
- Align and Color by 2D Scaffold
- Set Formal Charges
- Enumerate Formal Charge States
- Convert
- Build Prediction Model
- Predict using Model
- Generate 3D Conformers
- Generate Tautomers
- Generate Stereoisomers
- Calculate Ligand Energetics
- Chemical Clustering
- PCA Analysis
- Visualize Chemical Space
- Compare Two Sets (tables)
- Merge Two Sets (tables)
- Select Duplicates
- Multi Parameter Optimization
- Combinatorial Chemistry
- SAR Analysis
- Chemical Superposition
- APF Superposition
- APF Tools

7.1 Read Chemical Structures

Available in the following product(s): ICM-Chemist | ICM-Chemist-Pro
| ICM-VLS

|Video

Chemical structures can be read into ICM from MOL/MOL2, SMILES, and SDF files or you can construct your own structures by drawing them in the ICM Molecular Editor. Chemicals can also be searched and downloaded via the Search Tab using the PDB Chemical Substructure Search, search by PDB Ligand Code, or by searching DrugBank, ChEMBL, SureChEMBL or PubChem.

To read a chemical format file:

- Select File/Open.
- Select the chemical structure file you wish to open: MOL, MOL2 or SDF.
- Once selected the file will be displayed as a chemical table (See ICM molecular tables section).

If you know the chemical smiles string for the compound you can build the 2D molecule by:

- Select File/New.

- Click the **Compound** tab at the top of the window.
- Enter a name for the compound.
- Type in the **Smiles String** in the Smiles String data entry box. Remember to delete the previous string.
- Check the boxes Display Molecule Delete Other Objects according to your preference.
- Click the OK button.

Smiles can be read from a text file into a chemical table by:

- **File/Open** and select **Files of type:** Smiles format
- Then you can convert SMILES to 2D sketch using **Chemistry/Convert**.

Smiles can be read directly into the ICM Molecular Editor:

- Open the ICM Molecular Editor window.
- Select **Edit/Add Smiles**

Multi mol2 3D files can be read by:

- File/Open and select **Files of type:** mol2 format.

Chemicals can be read directly from ChEMBL, SureChEMBL, PubChem, and DrugBank

- Click on the `search` tab and find the database you wish to search in the drop down dialog box.

7.1.1 Extract 2D structure from PDB Chemical

To extract a 2D chemical representation from a PDB file into a chemical spreadsheet.

- Read the PDB file.
- Right click on the ligand and choose **Extract Ligand**.
- Choose whether you want to extract the 3D coordinates.
- Choose whether you want to append to an existing table (chemical spreadsheet).

7.1.2 Read Large SDF Files

The ability to read large SDF files (e.g. >100K chemicals) depends on the memory of your computer. A work around for this is available in ICM.

- File/Open and in the Filter Section choose "MDL sdf format as SMILES"
- The table header will contain an "S" symbol representing that the table contains a SMILES column rather than mol. Each cell will also be labeled "Smiles".

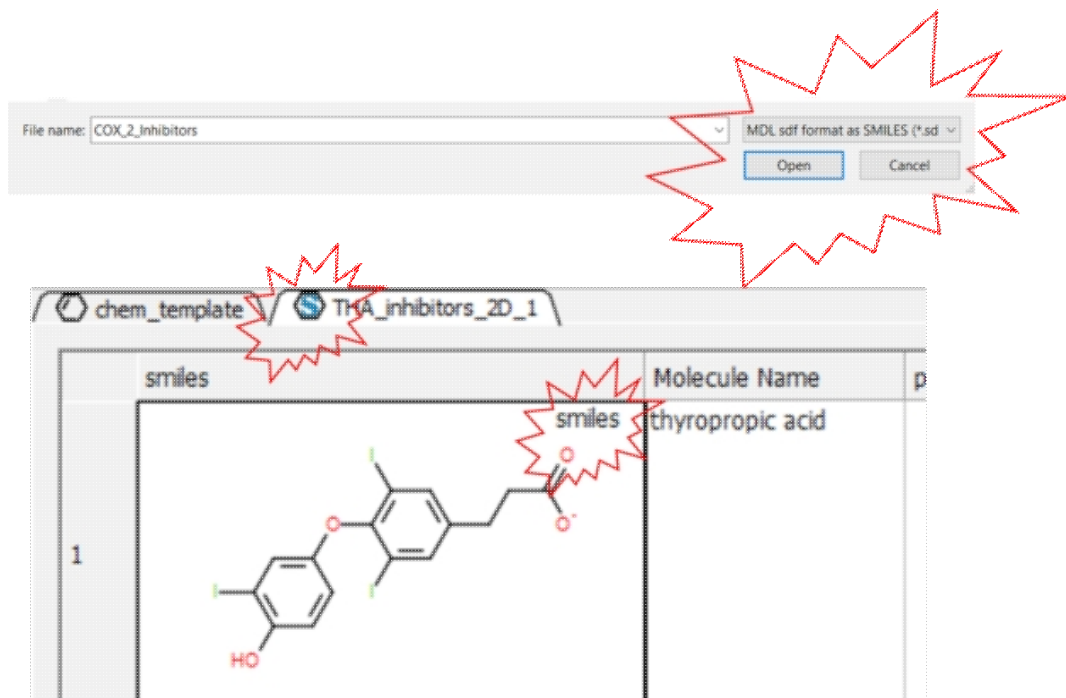

7.1.3 Extract 3D coordinates from 3D Chemical.

To extract the 3D coordinates of a chemical into a chemical spreadsheet e.g for 3D QSAR or after chemical superposition.

- Select the 3D chemicals in the ICM workspace. One or more can be selected by clicking holding the CTRL key and clicking. A range of chemicals can be selected by holding the keyboard tab and clicking.
- Right click on any of the selected chemicals in the ICM workspace and choose **Extract Ligand**.
- Select "keep 3D coordinates.
- Append to an existing table if needed.

7.2 Save Chemical Structures and Images

Available in the following product(s): ICM-Chemist | ICM-Chemist-Pro | ICM-VLS

There are a variety of ways to save chemical structures. Chemicals can be saved in mol, sdf and smiles format from a chemical table (spreadsheet), molecular editor or from the ICM-Workspace. An image of the 2D sketch can be saved as an image from a chemical table.

7.2.1 Save Chemical Spreadsheet Workspace

If you wish to save your chemical spreadsheet and plots and setup.

- File/Save As - ICM Binary Format (.icb)

7.2.2 Saving Chemical Spreadsheet as SDF

To save all the chemicals in a table as an SDF file:

- Right click on the chemical table header.

- Select **Save as..**
- Select **Save as type:** (SD file, Mol file or comma separated value - csv)

Right click here

	mol	MolWeight	MolPSA	MolLogS
1		7.226	157.205	-1.44554
2		312.29	114.926	-4.43001

To save selected chemicals in a table as an SDF file:

- Select the row(s) of the chemicals you wish to save in SDF format. Row selections in tables is described in the **Tables** chapter.
- Right click on any of the selected rows and select **Save Selection As....**

ricinLigands2D

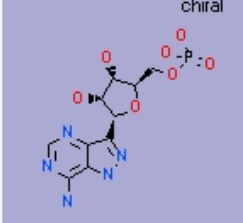
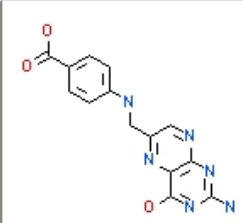
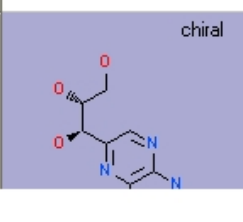
	mol	MolWei
1	 chiral	347.226
2		312.29
3	 chiral	253.219

Select rows here

Right click here

- Color By
- Clustering...
- Learn...
- Plot...
- Analysis
- Row Selection (2)
- Delete Rows
- Copy Selection to ICM Table
- Save Selection As...
- Save Selection As Csv+Headers...
- Edit Molecule...
- Query Molecule
- Chemistry
- Mark Selected Rows
- Select Marked Rows
- Copy Row(s) Ctrl+C
- Paste Ctrl+V
- Print Table... Ctrl+P

7.2.3 Export to Excel

To export to Excel:

- Right click on the table header and select "Export to Excel".

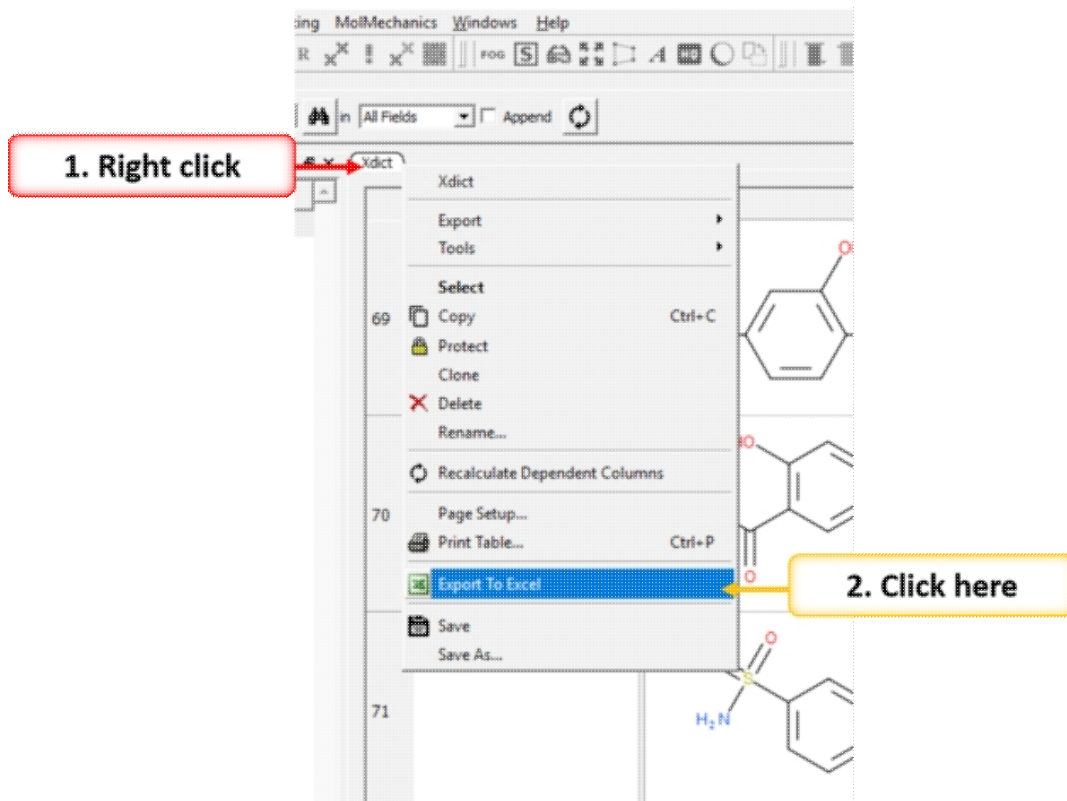

7.2.4 Saving Chemicals in the Molecular Editor

Chemicals drawn in the ICM Molecular Editor can be saved:

- **File/Save** or **File/Save As...** or **Edit/Copy as SMILES**

7.2.5 Saving Chemicals 3D Chemicals

If you have converted a chemical sketch into 3D, the 3D structure will be displayed in the ICM Workspace. To save this structure in mol format:

- Right click on the name of the chemical in the ICM Workspace.
- Select **Save As..**

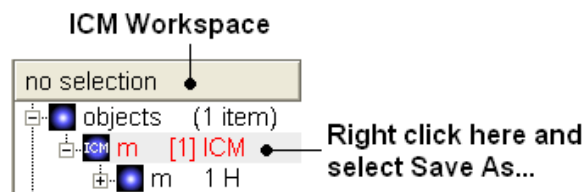

7.2.6 Saving Chemical Images

To save an image of a chemical sketch:

- The chemical needs to be displayed in a chemical table.
- Right click on the 2D image
- Select **Save Molecule As Image**

NOTE Using the right click options you can also save the image to the **clipboard** or copy the molecule to the ICM Image Album for use in Molecular Documents.

ICM photo album -
easy transfer of
images to ICM
Molecular Documents

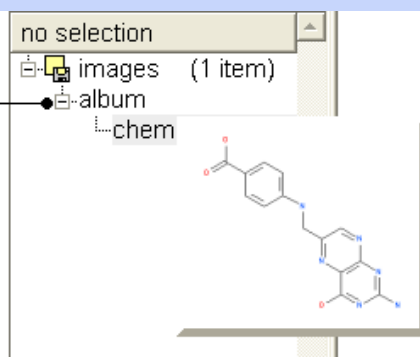

7.2.7 IUPAC Name

The IUPAC nomenclature for a compound can be generated on the fly for a chemical. You can view the IUPAC name in the **Molecule Editor** or you can insert a column into a chemical spreadsheet with the IUPAC name.

7.3 Working with Chemical Spreadsheets.

Available in the following product(s): ICM-Chemist | ICM-Chemist-Pro | ICM-VLS

When an sdf file is read into ICM it is displayed as a chemical spreadsheet. Many of the operations you can perform on chemical spreadsheets (Molecular Tables) are described in the **table** section of this manual. Some useful chemical-only options are described in this section.

An example of an ICM molecular table:

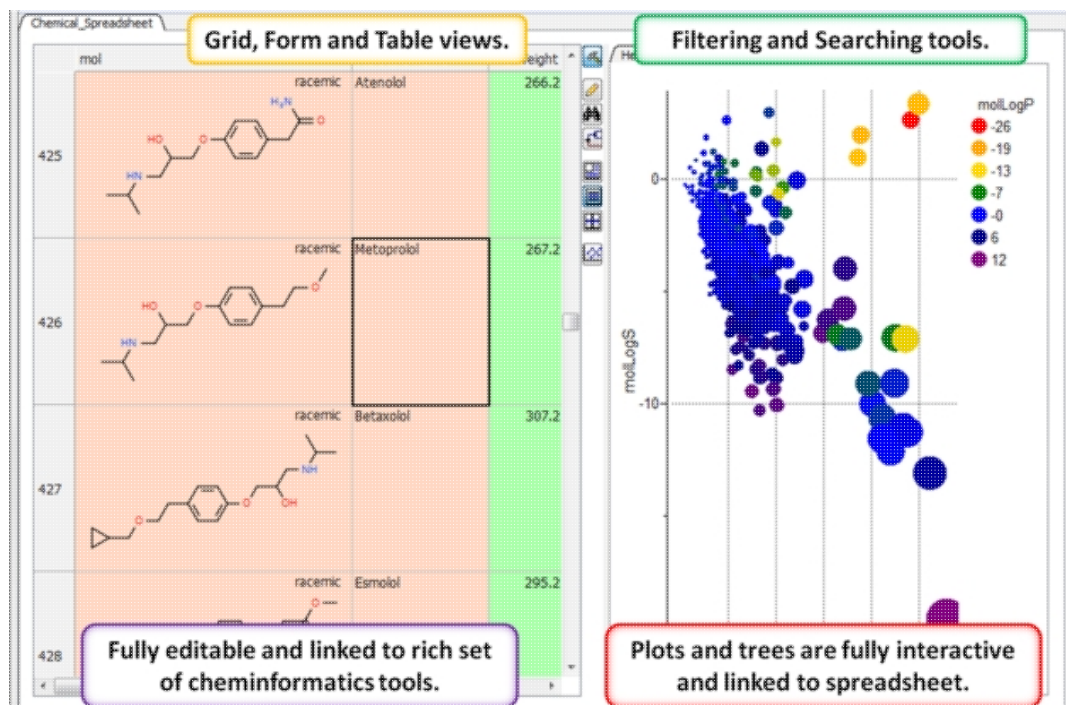

7.3.1 Read and Display Chemical Spreadsheet

When an sdf file is read (File/Open SDF) into ICM it is displayed as a chemical spreadsheet.

7.3.2 Chemical Spreadsheet Template

| Video |

To create a chemical spreadsheet table template:

- Chemistry/Create Empty Chemical Table
- Enter a name for the table.
- Choose whether you wish to add an ICM column and the prefix.
- Enter the number of empty rows you would like to insert.
- Click Next to select property columns.
- You can add plots and histograms to the template.

You can apply the template to new data by:

- Cut and paste or append the new data into the template or double click in a cell and edit the chemical. The chemical properties will be automatically calculated and the plots/histograms populated with data.

You can save a template by:

- Right click on the template listed in the ICM workspace (left hand side).
- Select Save As.. and choose Save as type ICM binary .icb

You can open a template by:

- File/Open file type ICM Binary .icb.

7.3.3 Molecular Table Display

| Video |

There are three built-in table views.

- Table View (Default)
- Grid View - select the columns you wish to display in a grid.
- Form View

You can toggle between each view using the buttons on the right hand side of the table shown below.

Toggle View

	molLogS	molPSA	molArea	
2	444.9	2.659	-4.313	75.59 498
5	410.7	0.3258	-3.092	106 452.9

Form
Grid
Table

Table View Default

id	Molecule Name	molLogS	molPSA	molArea	molWeight	molLogP			
355	355	430.2	9	2	444.9	-4.313	75.59	498	
356	356	403.2	10	5	410.7	-3.092	106	452.9	
357	357	430.2	9	2	443	-3.271	6.583	76.83	493.5

Grid View

Form View

7.3.4 How to add Property Columns into a Chemical Spreadsheet.

|Video|

To add chemical properties (e.g. MW, LogP, PSA etc...):

- Chemistry/Calculate Properties

7.3.5 How to sort a column(s) in a chemical spreadsheet.

How to sort a column(s) in a chemical spreadsheet.

1. Right click on a column header and select "Sort"

mol	NAME	mol	mol	mol	mol	mol	mol	mol	mol
<chem>C1=CC=C(C=C1)C(=O)O</chem>	C13H8N2O	104870	212.1	1.912	-0.61	27.46	C1C=NC=C1C(=O)C(=O)C(=O)C1	2	
<chem>C1=CC=C(C=C1)C(=O)O</chem>	C13H8N2O	104870	212.1	1.912	-0.61	27.46	C1C=NC=C1C(=O)C(=O)C(=O)C1	2	
<chem>C1=CC=C(C=C1)C(=O)O</chem>	C13H8N2O	104870	212.1	1.912	-0.61	27.46	C1C=NC=C1C(=O)C(=O)C(=O)C1	2	
<chem>C1=CC=C(C=C1)C(=O)O</chem>	C13H8N2O	104870	212.1	1.912	-0.61	27.46	C1C=NC=C1C(=O)C(=O)C(=O)C1	2	
<chem>C1=CC=C(C=C1)C(=O)O</chem>	C13H8N2O	104870	212.1	1.912	-0.61	27.46	C1C=NC=C1C(=O)C(=O)C(=O)C1	2	
<chem>C1=CC=C(C=C1)C(=O)O</chem>	C13H8N2O	104870	212.1	1.912	-0.61	27.46	C1C=NC=C1C(=O)C(=O)C(=O)C1	2	

7.3.6 How to copy, cut and paste columns and rows in a chemical spreadsheet.

For large data it is recommended to use Tools/Table/Append rows.

How to copy, cut, and paste columns and rows in a chemical spreadsheet.

1. Select a column or row by clicking on the header. (click and hold CTRL key for non-contiguous selections or SHIFT key for range)

2a. To copy, cut and paste rows – right click here on a selected row(s)

2b. To copy, cut and paste rows – right click here on a selected column(s)

mol	NAME	mol	mol	mol	mol	mol	mol	mol	mol
<chem>C1=CC=C(C=C1)C(=O)O</chem>	C13H8N2O	104870	212.1	1.912	-0.61	27.46	C1C=NC=C1C(=O)C(=O)C(=O)C1	2	
<chem>C1=CC=C(C=C1)C(=O)O</chem>	C13H8N2O	104870	212.1	1.912	-0.61	27.46	C1C=NC=C1C(=O)C(=O)C(=O)C1	2	
<chem>C1=CC=C(C=C1)C(=O)O</chem>	C13H8N2O	104870	212.1	1.912	-0.61	27.46	C1C=NC=C1C(=O)C(=O)C(=O)C1	2	
<chem>C1=CC=C(C=C1)C(=O)O</chem>	C13H8N2O	104870	212.1	1.912	-0.61	27.46	C1C=NC=C1C(=O)C(=O)C(=O)C1	2	
<chem>C1=CC=C(C=C1)C(=O)O</chem>	C13H8N2O	104870	212.1	1.912	-0.61	27.46	C1C=NC=C1C(=O)C(=O)C(=O)C1	2	
<chem>C1=CC=C(C=C1)C(=O)O</chem>	C13H8N2O	104870	212.1	1.912	-0.61	27.46	C1C=NC=C1C(=O)C(=O)C(=O)C1	2	

7.3.7 Add New Data to Chemical Spreadsheet

To add new data to a chemical spreadsheet:

- Use Tools/Table/Append rows.

7.3.7.1 Highlight New Data

To highlight new data added to chemical spreadsheet.

- Use Tools/Table/Append rows.
- Choose the option to **Select New Rows**.
- Mark the selected rows.

7.3.8 How to show and hide columns and rows in a chemical spreadsheet.

How to hide rows in a chemical spreadsheet.

The screenshot displays a chemical spreadsheet with columns labeled 'NAME', 'molwt', 'logP', and 'SMILES'. Row 2 is highlighted in purple, and a context menu is open over it. The menu options include Cut Row(s), Copy Row(s), Paste Row(s), Freeze Row(s), Delete Row(s), Hide Rows, Insert Empty Row Before, and Insert Empty Row After. The 'Hide Rows' option is highlighted in the menu.

1. Select row(s) (click and hold CTRL key for non-contiguous selections or SHIFT key for range)

2. Right click here and select "Hide Rows"

NAME	molwt	logP	SMILES
C13H20	168.26	172.1	1.531
C13H20	168.26	172.1	1.531
C13H20	168.26	172.1	1.531
C13H20	168.26	172.1	1.531
C13H20	168.26	172.1	1.531
C13H20	168.26	172.1	1.531

```

Info: temp_p_tocn_ternm_2_yolCgH0ew_2_mcr_ternm_0d0ig_1_tableOutput_1_gbzss_1_m0ss0m_1_m0m0w0e0ternm_1_display_1_delete_h_00_t0edit_w_0ap_w_0n0t0ch_0mp_0var0ab0e_0d0el0t0
[com/dez delete all]
[com/dez uddisplay window]
[com/dez_0_m00000Project_0_0]
[com/dez_000d0i0e_0C:\V0id0e\0sub0str0ucture_0.m0e"]
Info: table "substructure" ( 0 header, 8 straps(10000)) created
[com/dez_0_0]
  
```

How to hide columns in a chemical spreadsheet.

1. Select column(s) (click and hold CTRL key for non-contiguous selections or SHIFT key for range)
2. Right click here and select "Hide Column(s)"

7.3.9 How to save a chemical spreadsheet in sdf format.

How to save a chemical spreadsheet in sdf format.

1. Right click on the spreadsheet header tab
2. Select "Save As.."

7.3.10 How to export your chemical spreadsheet into Excel.

How to export a chemical spreadsheet into Excel.

1. Right click on the spreadsheet header tab

2. Select "Export To Excel"

substructure	NAME	molwt	molLogP	molPSA	molR6			
1	C13H18N2	202.26	1.721	1.911	-2.531	28.11	NC1=CC=C(C=C1)C1=CC=CC=C1	2
2	C13H18N2	160.193	2.051	1.625	-3.214	28.13	C1=CC=C(C=C1)C1=CC=CC=C1	2
3							NC1=CC=C(C=C1)C1=CC=C1	2
4	C13H18N2	99.072	2.123	1.912	-3.61	27.46	C1=CC=C(C=C1)C1=CC=CC=C1	1
5	C13H18N2	153.145	2.141	1.896	-3.307	28.48	NC1=CC=C(C=C1)C1=CC=CC=C1	2
6	C13H18N2	160.193	2.141	2.026	-3.869	28.13	C1=CC=C(C=C1)C1=CC=CC=C1	2

7.3.11 How to print a chemical spreadsheet.

How to print a chemical spreadsheet.

1. Right click on the spreadsheet header tab

2. Select "Print Table"

substructure	NAME	molwt	molLogP	molPSA	molR6			
1	C13H18N2	202.26	1.721	1.911	-2.531	28.11	NC1=CC=C(C=C1)C1=CC=CC=C1	2
2	C13H18N2	160.193	2.051	1.625	-3.214	28.13	C1=CC=C(C=C1)C1=CC=CC=C1	2
3							NC1=CC=C(C=C1)C1=CC=C1	2
4	C13H18N2	99.072	2.123	1.912	-3.61	27.46	C1=CC=C(C=C1)C1=CC=CC=C1	1
5	C13H18N2	153.145	2.141	1.896	-3.307	28.48	NC1=CC=C(C=C1)C1=CC=CC=C1	2
6	C13H18N2	160.193	2.141	2.026	-3.869	28.13	C1=CC=C(C=C1)C1=CC=CC=C1	2

7.3.12 How to filter columns in a chemical spreadsheet.

NOTE: You can also use the filter slide bars in the table tools panel. | Video |

How to filter columns in a chemical spreadsheet (1).

1. Right click on the column header you wish to filter

2. Select Filter Custom or From List...

How to filter columns in a chemical spreadsheet (2).

2. This symbol indicates the column is filtered

1. Enter filters

To remove a filter right click on the column that is filtered and select Filter/Clear

mol	molLogP	molWt	molLogP	molWt	molLogP	molWt	molLogP	molWt		
1	4.75	7.196	42.74	336	134.4	0.0017	3	1		
2	3.924	6.126	42.74	314	128.1	0.07959	3	1		
3	6.576	300	1.925	4.688	52.56	202.2	96.47	0.00176	3	2
4	6.525	373.1	4.255	5.809	42.52	268.4	79.3	0.6077	3	1
5	6.6	317	2.206	4.619	43.16	248.4	99.96	0.129	3	1
6	6.675	331	2.759	5.176	42.63	268.4	95.96	0.2819	3	1
7	7.275	346.1	3.102	5.125	44.1	268.4	95.96	0.2819	3	1

7.3.13 How to use find and replace in a chemical spreadsheet.

How to use find and replace in a chemical spreadsheet.

1. Right click on the mol column
2. Select Chemical Find and Replace
3. Use the editor to sketch the group you want to find
4. Use the editor to sketch the group you want to replace with

You can also do text find and replace by right clicking anywhere on the table and select Find and Replace.

7.3.14 How to mark and label rows in a chemical spreadsheet.

How to mark and label rows in a chemical spreadsheet.

1. Select the row(s) you wish to label by clicking on the row number. Click and hold CTRL key for non-contiguous selections or SHIFT key for range.
2. Right click on the selected row and choose "Mark Selected Rows" Select a color label.
3. You can select marked (labeled) rows here.

7.3.15 How to insert hyperlinks to the PDB, PubMed, and Uniprot.

How to insert hyperlinks.

1. Right click on the column header and select "Format"

2. Choose hyperlink type here

3. Click OK and the hyperlink will be generated

	mol	molM	molWeight	molLogP	molLogD	molPSA	molMolarWeight	molMW	drug likeness	molHBA	molHBD	job
1		6	471	4.775						3		1Job
2		6	380.1	3.924						3		2Job
3		6	211						0.2003	3		2Job
4		6.375	301						0.007176	3		2Job
5		6.6	317	2.206	4.611				0.6977	3		1Job
6		6.675	321	2.768	6.176	42.63	260.4	95.96	0.2019	3		1Job

```
low/de> binding_data.pdb[4] = "4abc"
low/de> binding_data.pdb[5] = "5abc"
low/de> binding_data.pdb[6] = "6abc"
low/de> binding_data.pdb[7] = "7abc"
low/de> net docset binding_data.pdb "ok http://www.rcsb.org/pdb/explore/explore.do?structureId=1L31/c/s" same*** noJob***
low/de>
```

7.3.16 How to copy and paste 2D chemicals.

How to copy and paste 2D chemicals.

1. Right click on the 2D chemical.

2. Select "Copy 2D Molecule"

	mol	molM	molWeight	molLogP	molLogD	molPSA	molMolarWeight	molMW	drug likeness	molHBA	molHBD	job
1		6	471	4.775	-7.136	42.74	306	134.4	0.69071	3		1Job
2		6	380.1	3.924	4.126	42.74	314	126.1	0.67969	3		1Job
3		1.1	1.376	-3.533	53.02	163.3	88.27		0.2003	3		2Job
4		6.375	301	1.925	4.688	52.96	222.2	98.47	0.907176	3		2Job
5		1.1	4.205	6.808	42.92	310.4	79.3		0.6977	3		1Job
6		6.675	321	2.768	6.176	42.63	260.4	95.96	0.2019	3		1Job

```
low/de> binding_data.pdb[4] = "4abc"
low/de> binding_data.pdb[5] = "5abc"
low/de> binding_data.pdb[6] = "6abc"
low/de> binding_data.pdb[7] = "7abc"
low/de> net docset binding_data.pdb "ok http://www.rcsb.org/pdb/explore/explore.do?structureId=1L31/c/s" same*** noJob***
low/de>
```

7.3.17 How to edit data inside a chemical spreadsheet.

How to edit data inside a chemical spreadsheet.

1. Click here

2. Edit data by double clicking on the data.

	mol	kw	subweight	mol_wpt	mol_wpt	mol_wpt	mol_wpt	mol_wpt	mol_wpt	mol_wpt	mol_wpt	mol_wpt	mol_wpt	mol_wpt	mol_wpt	mol_wpt	mol_wpt	mol_wpt	mol_wpt	mol_wpt
1	<chem>C1=CC=C(C=C1)C2=CC=CC=C2</chem>		6	471	4.775	7.136	42.74	336	134.4	0.00017	3	13tab								
2	<chem>C1=CC=C(C=C1)C2=CC=CC=C2</chem>		383.1	3.924	4.126	42.74	314	126.1	0.07969	3	13tab									
3	<chem>C1=CC=C(C=C1)C2=CC=CC=C2</chem>		6					89.27	0.2001	3	13tab									
4	<chem>C1=CC=C(C=C1)C2=CC=CC=C2</chem>		6.375					98.47	0.007176	3	13tab									
5	<chem>C1=CC=C(C=C1)C2=CC=CC=C2</chem>		6.525	373.1	4.255	6.803	42.92	384.4	79.3	0.03077	3	13tab								
6	<chem>C1=CC=C(C=C1)C2=CC=CC=C2</chem>		6.6	317	2.206	4.619	43.16	284.4	99.96	0.129	3	13tab								
6.675			331	2.759	6.176	42.63	284.4	99.96	0.2019	3	13tab									

7.3.18 How to remove salts, explicit hydrogens and standardize chemical groups.

How to remove salts, explicit hydrogens and standardize chemical groups.

1. Chemistry/Standardize

2. Select here

3. Select Files tab for batch mode

Standardize

Molecule Table: binding_data

Options:

- Remove Salts
- Remove Explicit Hydrogens
- Standardize Groups

Ok Cancel Help

7.3.19 How to calculate chemical properties in a chemical spreadsheet.

How to calculate chemical properties in a spreadsheet.

1. Chemistry/Calculate Properties

2. Select properties

3. Properties will be displayed in new columns

Function	Name	Category	Description
<input checked="" type="checkbox"/> MolWeight(mol)	molWeight	Chemical	Molecular weight
<input type="checkbox"/> MolFormula(mol)	molFormula	Chemical	Chemical formula e.g. CH4O
<input type="checkbox"/> IupacName(mol)	iupacName	Chemical	IUPAC nomenclature name
<input type="checkbox"/> MolLogP(mol)	molLogP	Chemical	Octanol water partition, LogC _{ow} =C
<input checked="" type="checkbox"/> MolLogS(mol)	molLogS	Chemical	Water solubility LogC _{ow} =SPH
<input type="checkbox"/> MolPSA(mol)	molPSA	Chemical	Polar surface area
<input checked="" type="checkbox"/> MolMolWeight(mol)	molMolWeight	Chemical	Molecular weight
<input type="checkbox"/> MolMolFormula(mol)	molMolFormula	Chemical	Chemical formula
<input type="checkbox"/> MolMolIupacName(mol)	molMolIupacName	Chemical	IUPAC nomenclature name
<input type="checkbox"/> MolMolLogP(mol)	molMolLogP	Chemical	Octanol water partition, LogC _{ow} =C
<input type="checkbox"/> MolMolLogS(mol)	molMolLogS	Chemical	Water solubility LogC _{ow} =SPH
<input type="checkbox"/> MolMolPSA(mol)	molMolPSA	Chemical	Polar surface area
<input type="checkbox"/> MolMolMolWeight(mol)	molMolMolWeight	Chemical	Molecular weight
<input type="checkbox"/> MolMolMolFormula(mol)	molMolMolFormula	Chemical	Chemical formula
<input type="checkbox"/> MolMolMolIupacName(mol)	molMolMolIupacName	Chemical	IUPAC nomenclature name
<input type="checkbox"/> MolMolMolLogP(mol)	molMolMolLogP	Chemical	Octanol water partition, LogC _{ow} =C
<input type="checkbox"/> MolMolMolLogS(mol)	molMolMolLogS	Chemical	Water solubility LogC _{ow} =SPH
<input type="checkbox"/> MolMolMolPSA(mol)	molMolMolPSA	Chemical	Polar surface area

7.3.20 InChi

To convert a column containing an InChi key to 2D structure or vice-versa 2D structure to InChi key:

- Right click on a column and select Insert Column
- Choose Function -> Chemical -> Select 2DfromInChi or Inchi

7.3.21 How to identify duplicate chemicals in a chemical spreadsheet.

How to identify duplicate chemicals in a spreadsheet.

- 1. Chemistry/Select Duplicates...**
- 2. Enter table/spreadsheet name**
- 3. Duplicate compounds will be selected and highlighted in blue**

```

low/de> set format binding_data.pdf %c href=http://www.ncbi.nlm.nih.gov/pub/explore/explore.do?term=entryID:131131/40&rank=1000000000
low/de> read table binding_data select index = Index( binding_data.mol exact stereo )
Info: 1 hits selected in binding_data
low/de> find table binding_data select index = Index( binding_data.mol exact stereo )
Info: 1 hits selected in binding_data
low/de>
  
```

7.3.22 How to compare two chemical spreadsheets.

How to compare two chemical spreadsheets.

- 1. Chemistry/Compare Two Sets...**
- 2. Choose the tables you want to compare**
- 3. Select the comparison method and output**

```

low/de> find table binding_data select index = Index( binding_data.mol exact stereo )
Info: 1 hits selected in binding_data
low/de> openfile 'F:\teaching\course1\low-chem1-emlinc-1209\binding_data_array2.pdf' @ you so so so **
Info: table 'binding_data_array2' ( 0 headers, 2 arrays(23) ) created
low/de> delete binding_data_array2.NAME_
low/de>
  
```

7.3.23 How to merge two chemical spreadsheets.

1. Chemistry/Merge Two Sets...

2. Choose the tables you want to compare

3. Select the way you want to merge them

7.3.24 Display and Convert Molecule

To display and convert a molecule from a molecular table in the 3D graphics display window:

- Select the molecule image or images in the molecular table.
- Right click and select the Chemistry/ Convert to 3D option.

2

Edit DB Record...

Query Molecule

Chemistry

Copy Row(s) Ctrl+C

Paste Ctrl+V

Print Table... Ctrl+P

Enumerate Stereoisomers (selected rows)

Enumerate Tautomers (selected rows)

Remove Salt (selected rows)

Convert to 3D and Optimize

Load and Preserve Coordinates

Conformation Generator (selected rows)

Chemical Template Superposition (selected rows)

7.3.25 Copy Molecule

To copy a molecule to paste into another application or into the ICM Molecular Editor:

- Right click on the molecule and a menu will be displayed.
- Select the option "Copy Molecule"

To copy a molecule or image to paste into another row within an ICM table or into the ICM Molecular editor:

- Right click on the molecule and a menu will be displayed.
- Select the option "Copy Molecule"
- Right click in the cell into which you wish to paste the molecule.
- Select the option "Paste Molecule"

NOTE: To learn how to insert a row read the `insert row` section.

Molecules drawn in ICM can be cut and pasted into ISIS-Draw and molecules from ISIS-Draw can be cut and pasted into ICM.

To perform these functions the correct settings need to be turned on in ISIS-Draw so that the compound drawing is saved in the clipboard.

IN ISIS-DRAW - Go to Options/Settings/General/Copy Mol Rxn file to the clipboard.

Compounds drawn in ISIS Draw can be cut and pasted into the ICM Molecular Editor and into ICM tables. Compounds can be copied in ICM by:

- Right click on the compound in the chemical table and select Copy Molecule.

7.3.26 Edit Molecule

To edit a molecule:

- Right click on the molecule and a menu will be displayed.
- Select the option **Edit Molecule** and the ICM Molecular Editor will be displayed.
- Edit the molecule.
- Click Exit in the ICM molecular editor.

7.3.27 Color Table Column

You can color your table based on values within a column by: You can also color the compound according to specific values see `Color Chemical Structure`.

- Selecting the column.
- Right click on the column header and a menu will be displayed.
- Select the option "Color By"

NOTE: You can remove the color from the table by right clicking on the column header selecting **Clear Selection Color**.

Links to other coloring options:

- Rows can be colored by marking them as described [here](#).
- A 2D chemical sketch can be colored according to specific values (e.g. pharmacophore features) see `Color Chemical Structure`.

7.3.28 Chemical View Options

Different chemical view options in the ICM molecular table can be set.

- Right click on the "mol" column header.
- Select Chemical view options... and the following data entry box will be displayed

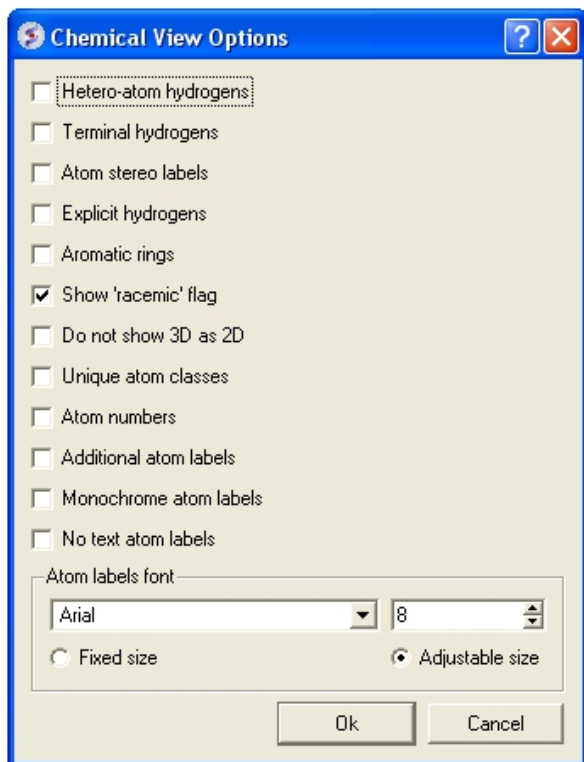

Options can be changed by checking the appropriate boxes or by entering the desired font and size.

7.3.29 Chemical Table Side-by-Side View

Chemical tables can be visually compared by placing them side-by-side. This can be done by:

- Double click on the table header for side-by-side view.
- Double click on the table header again to remove side-by-side view.

Double click here for "side-by-side" view

		mol	MolWeight	MolLogP	MolLogS
1		142.118	-0.589686	-1.70292	
2		150.141	-0.070759	-2.11729	

7.3.30 Zoom, Translate and Z-rotate a Chemical in a table.

Sometimes you may want to get a better view of a chemical in an ICM molecular table you can do this inside the chemical table by:

- Double clicking on the chemical drawing and the background will turn yellow.

Left click and drag here to zoom

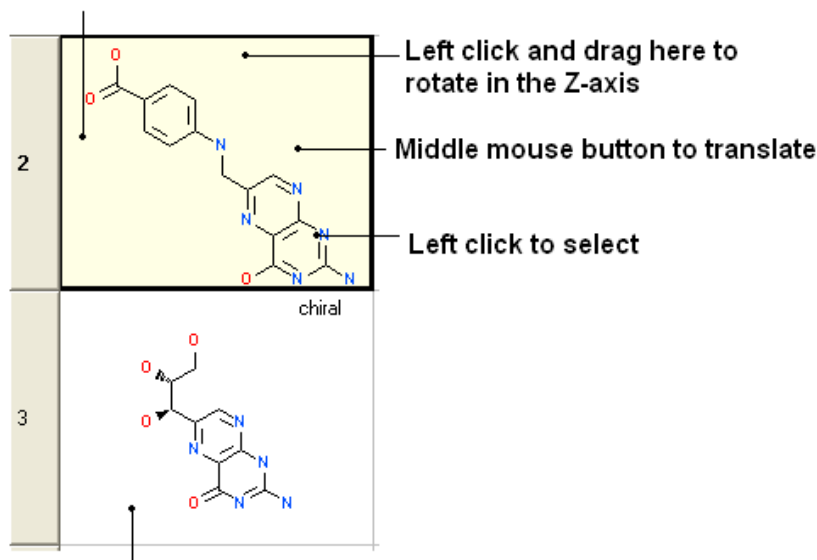

Double click for yellow background to enable changes in chemical display

NOTE: You can also browse your structures in 3D. See section entitled "Set Chemical Table 3D Browse Mode".

7.3.31 Set Chemical Table 3D Browse Mode

To browse the chemicals contained within a Chemical Spreadsheet in the graphical display:

- Right click on the "mol" column header.
- Select the option "Set 3D Browse Mode".
- Use the box in the column "L" to toggle the 3D display on and off.
- Multiple chemicals can be displayed by selecting the rows and then checking the box.

ricinLigands2D TAUTOMERS

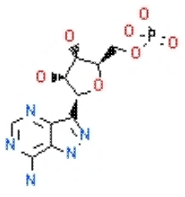
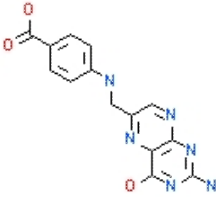
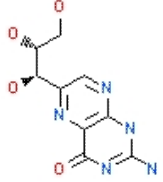
	mol	L	NAME
1	 <p>chiral</p>	<input checked="" type="checkbox"/>	
2		<input type="checkbox"/>	
3	 <p>chiral</p>	<input checked="" type="checkbox"/>	

Double click here to rotate the molecule in 3D in the cell.

3D Graphics

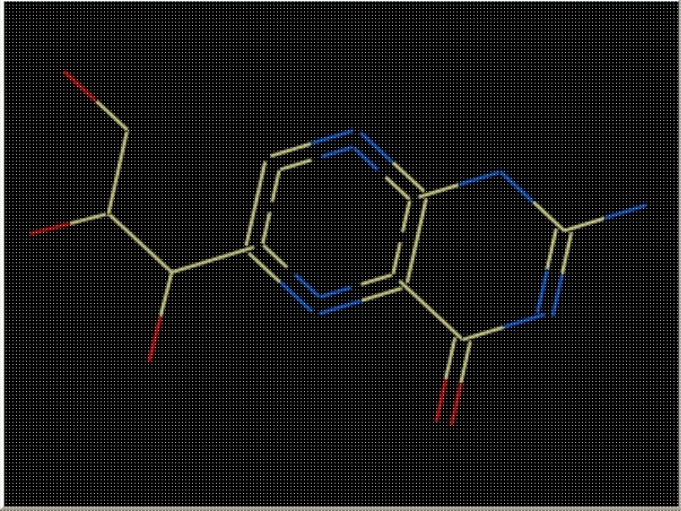

Toggle the display of the chemical in the 3D graphics window using the check box.

To remove 3D browse:

- Right click on the "mol" column header.
- Select UnSet 3D Browse Mode.

7.3.32 Chemical Find and Replace

Chemical Find&Replace tool allows you to find an arbitrary chemical fragment with one or more attachment point(s) and replace it with another fragment with the same number of attachment points.

To find a substructure and replace it with something else:

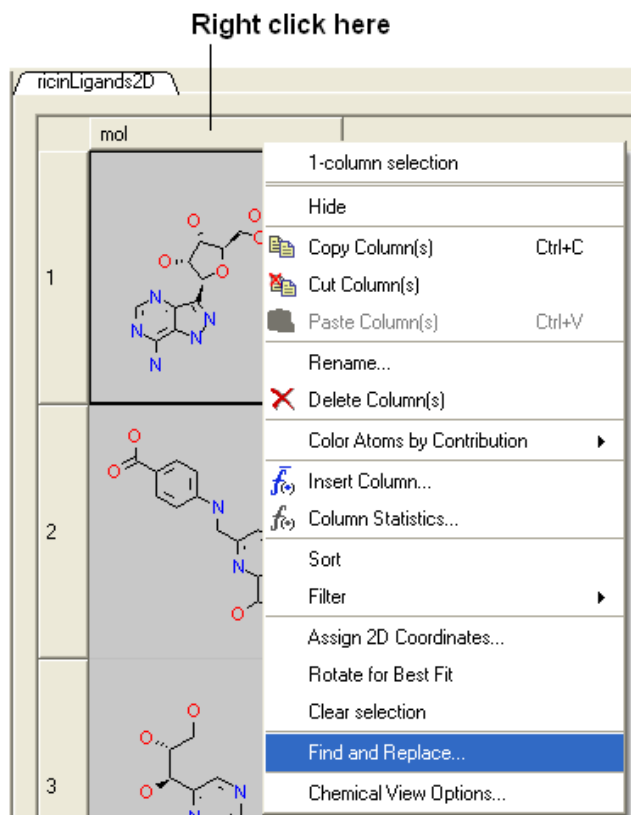

- Select the column in which the molecular structures are displayed. The column is usually called "mol".
- Right click on the "mol" column header and select Find and Replace. A data entry box as shown below will be displayed.

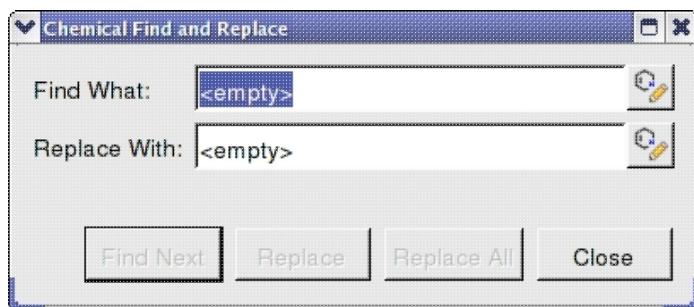

- Click on the Molecular Editor button at the end of the Find What: data entry box.
- The ICM Molecular Editor will be displayed. Draw the substructure you wish to search for and replaced.
- Draw the pattern and mark attachment points with R1,R2.... R-groups can be added by right clicking at the attachment point and selecting the R-group from the drop down options.
- Close the ICM Molecular Editor and the string will be displayed.
- Repeat with the "Replace With:" data entry box. Make sure the same number of R1,R2... labels are drawn.
- Click the Find Next button and then Replace or Replace All. When a substructure to replace is identified it will be colored red.

NOTE: There are a number of keyboard shortcuts which can be used to draw chemicals. Also please note that an aromatic bond in the source molecule will not match a double bond in the replacement pattern.

Here is an example:

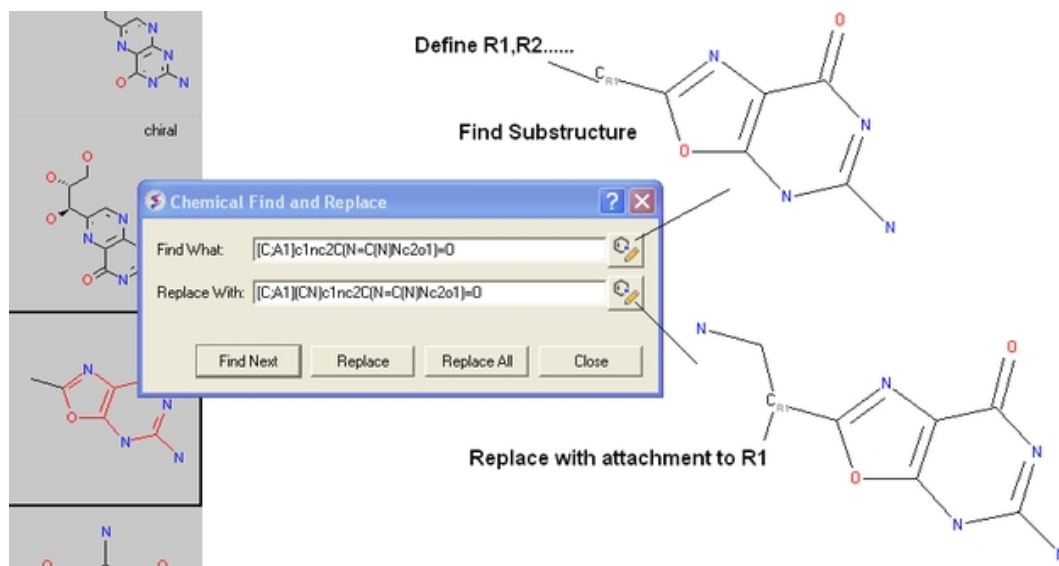

7.3.33 Split Chemical(s) into Fragments

Chemicals displayed in an ICM Molecular Table can be split into fragments. This is useful for generating a series of R-groups to be added to a scaffold (See section describing reactions).

To generate fragments:

- Select the column or row(s) you wish to generate the fragment from.
- Right click on the "mol" column header and select "Split Into Fragments".
- A new table of chemical fragments will be displayed. Each fragment is assigned an attachment point which is flagged with an asterisk (*).

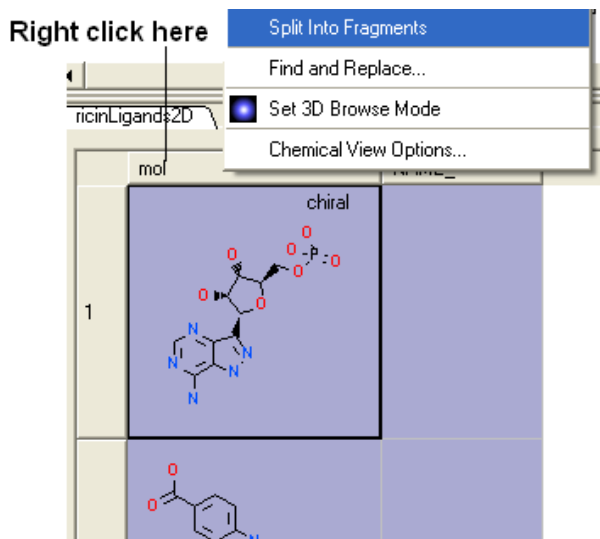

New table is generated containing fragments

ricinLigands2D R_R1

	mol	cnt	n_apo
1		1	1
	chiral	1	2

Attachment Point

7.3.34 Rotate Chemical for Best-Fit

To improve the display of a chemical within an ICM molecular table you can choose an option called "Rotate for best fit".

This option can be found by:

- Right click on the "mol" column header.
- Select "Rotate for Best Fit"

7.3.35 Color Chemical Structure

To color the structure of a chemical in an ICM molecular table by fragment of pharmacophore frequency:

- Right click on the "mol" column header.
- Select Color Structure By
- Select "By Fragment Frequency" or "By Pharmacophore Features"

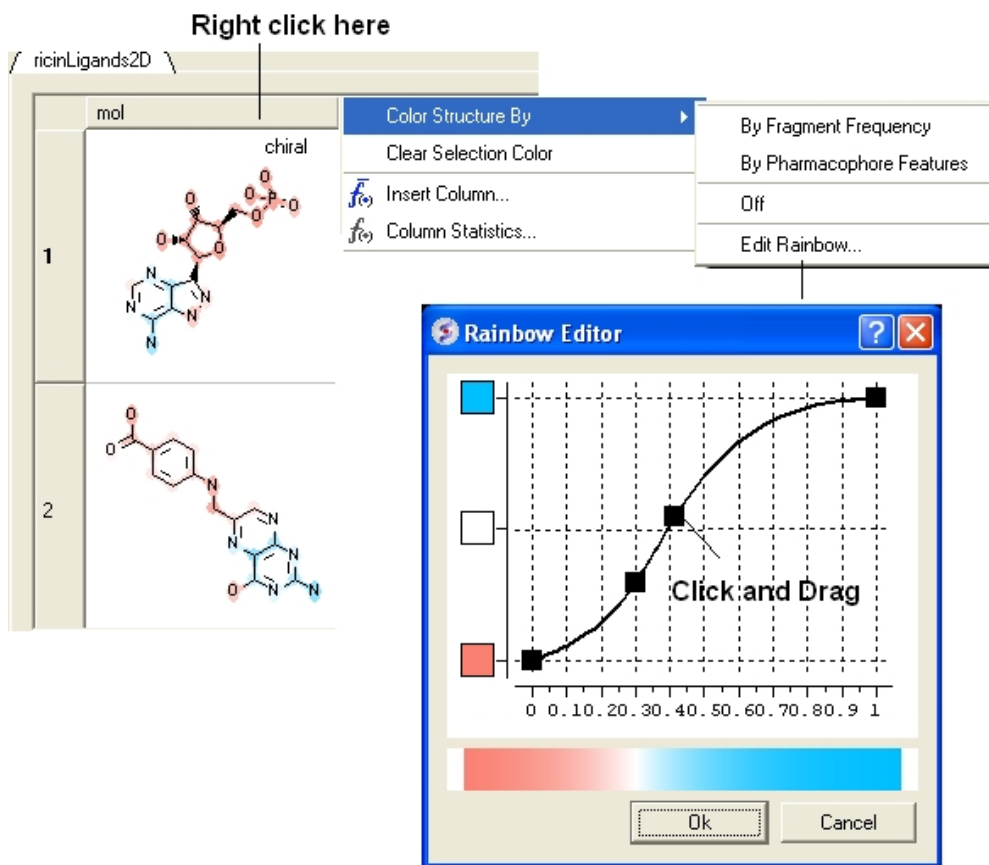

NOTE: The coloring can be controlled using the "Edit Rainbow" option and the coloring can be removed using the "Off" option

7.4 Molecular Editor

Available in the following product(s): ICM-Chemist | ICM-Chemist-Pro | ICM-VLS

| Video |

Draw new compounds by using the ICM Molecular Editor.

The molecular editor can be activated by:

- Clicking on the Open ICM Molecular Editor button shown below.

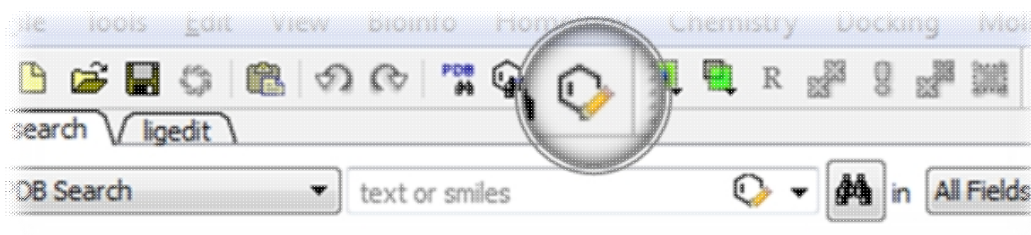

OR

- Select Chemistry/Molecular Editor and the editor as shown below will be displayed.

7.4.1 Drawing a New Chemical Structure

To draw a new chemical structure the ICM Molecular Editor should be loaded.

To do this:

- Select Chemistry/Molecular Editor

Now you can start drawing your structure.

- First select an atom, bond or ring and then click in the white Molecular Editor Workspace to start sketching.

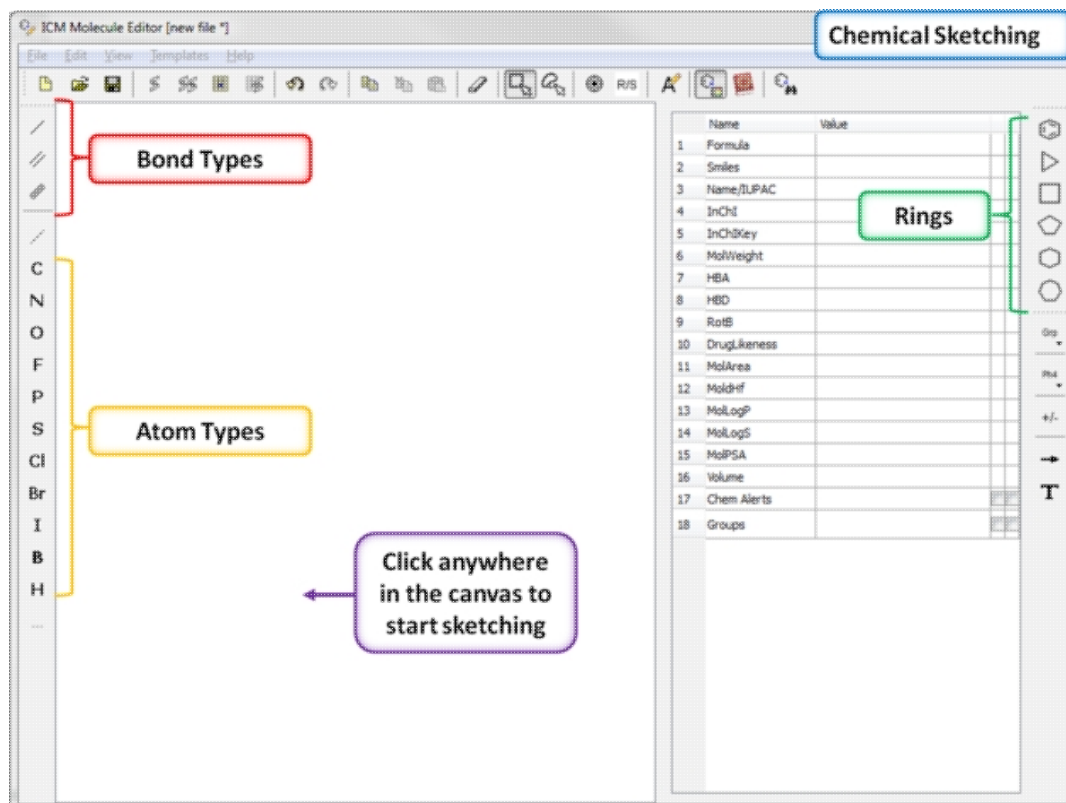

- You can extend your structure by selecting another atom, bond or ring.
- Select where on the structure you would like to add the new group by hovering the mouse over the desired position. The position you will add to will be highlighted in a red box.

Hover over an atom and new bonds or atoms will be added from the position highlighted by a red box

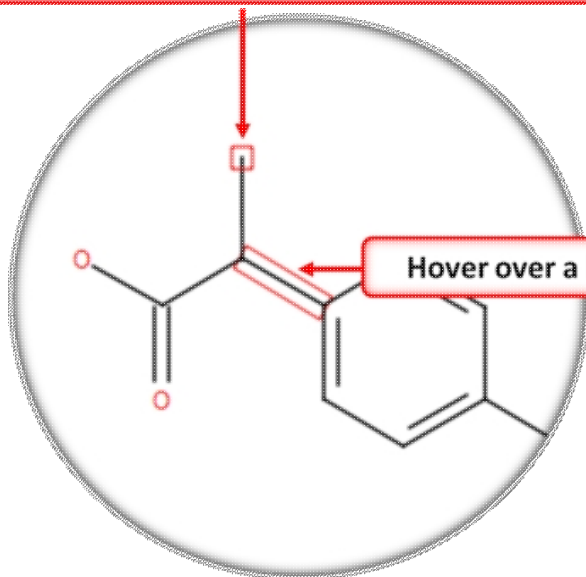

Hover over a bond to change type

7.4.2 Stereo Bond

To set the stereo bond type:

- Right click on the bond and a menu as shown below will be displayed.
- Select which bond direction you desire from up, down or either.

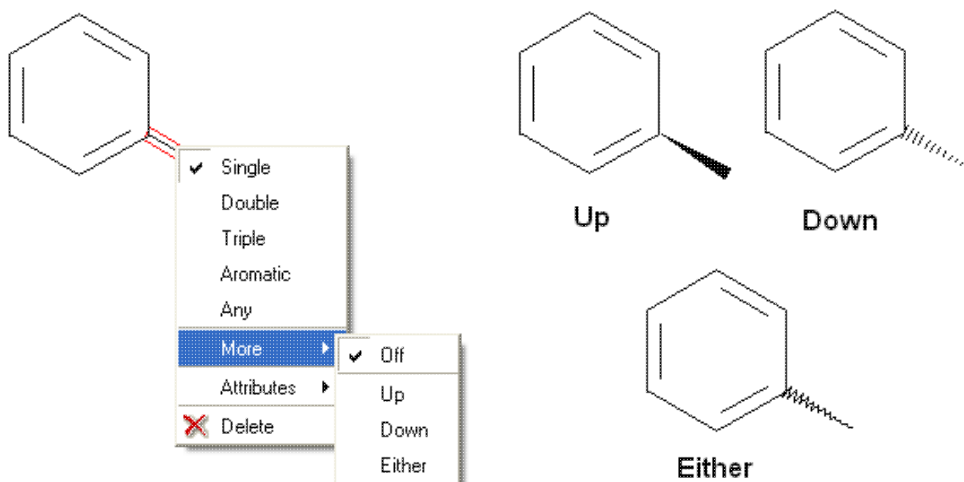

7.4.3 Right Click Options

There are a number of different options available when you **right click** on a **bond** or **atom**. These can be used for editing bond and atom types and there are additional options for Chemical Searching.

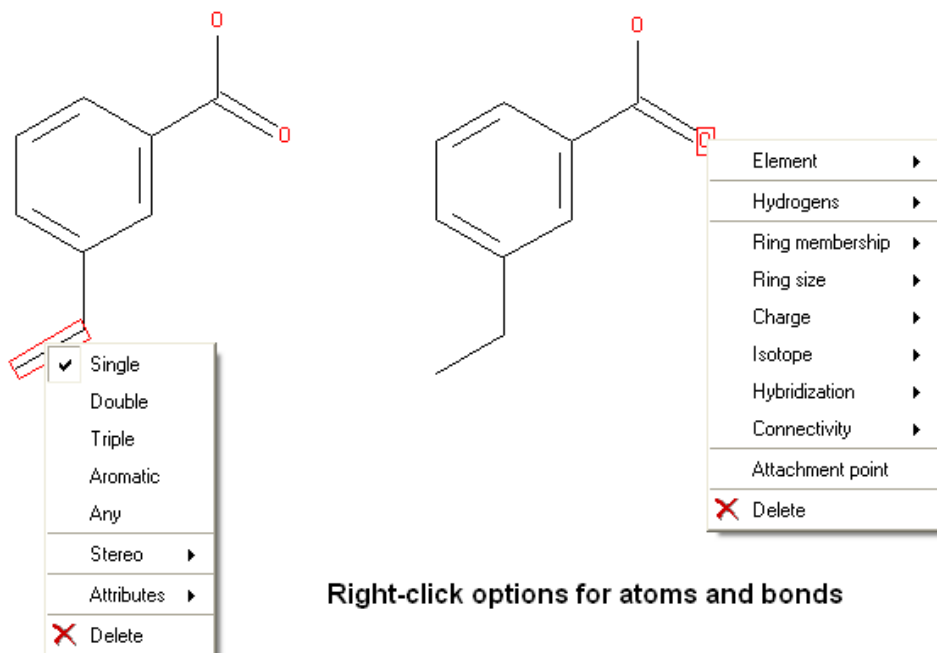

Right-click options for atoms and bonds

7.4.4 Chemical Dictionary

There is an inbuilt chemical dictionary which enables you to import a 2D sketch quickly. To use it:

- Click on the chemical dictionary button.
- Start typing the name of the chemical.
- Select the chemical from the drop down list.

7.4.5 Dictionary of Chemical Groups

The ICM Chemical Editor has a dictionary of chemical groups. These groups are stored in a table stored in `CHEM_GROUPS.csv` file. This file can be manually edited to remove or add new definitions. The group can be selected using the Grp button of the Editor.

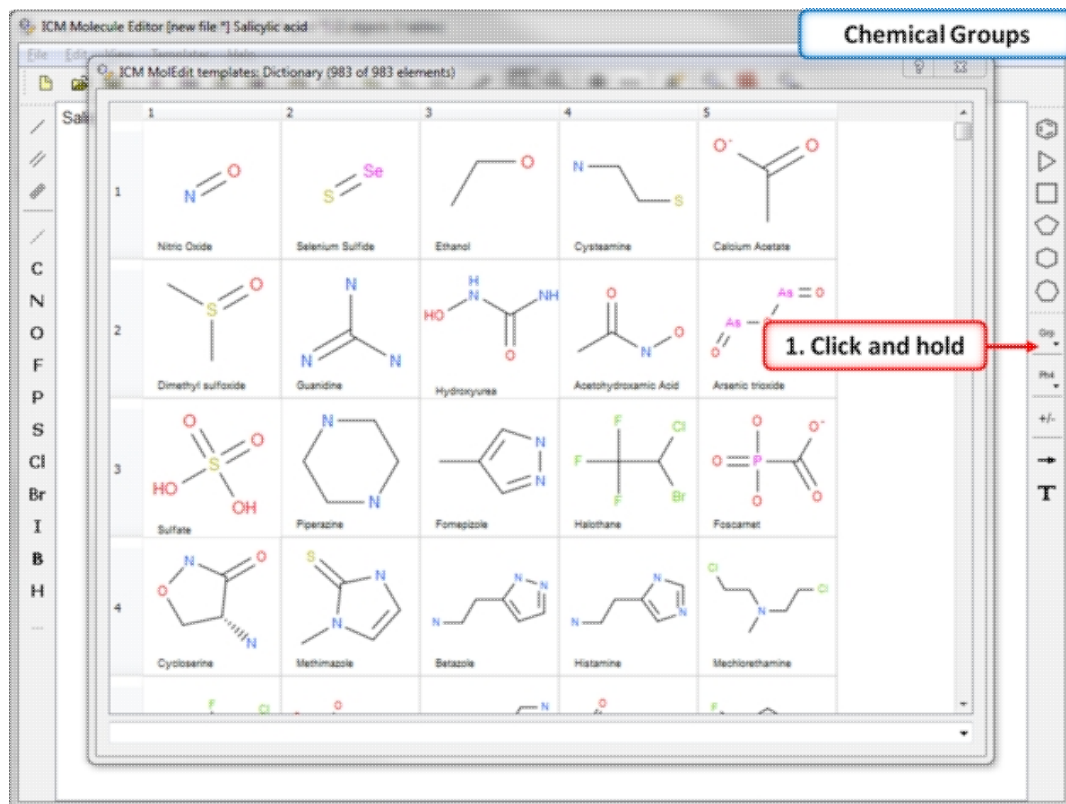

7.4.6 Template Menu

A set of chemical templates are available for:

- amino acids
- bases
- bicyclics
- rings

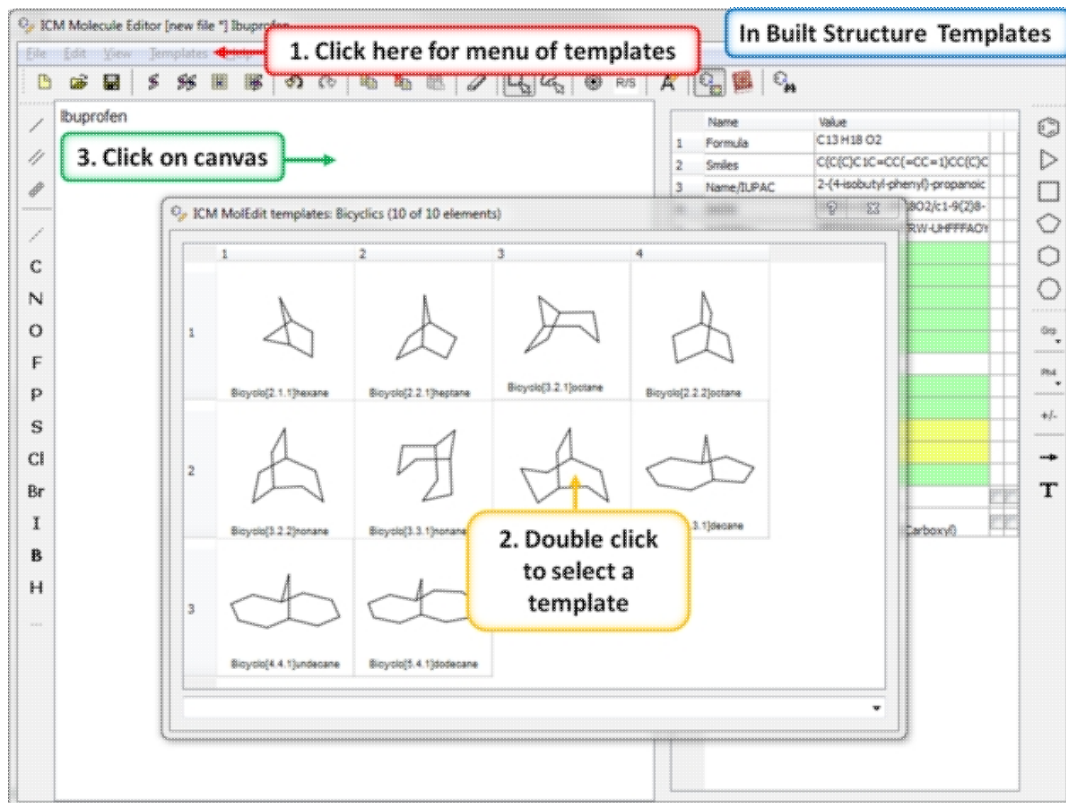

7.4.7 Set Free Radical Type

To set a free radical type (singlet, doublet or triplet) to an atom:

- Sketch the ligand in the Molecular Editor.
- Right click on the atom and select the free radical type.
- Convert to 3D or add to a chemical table if needed for docking.

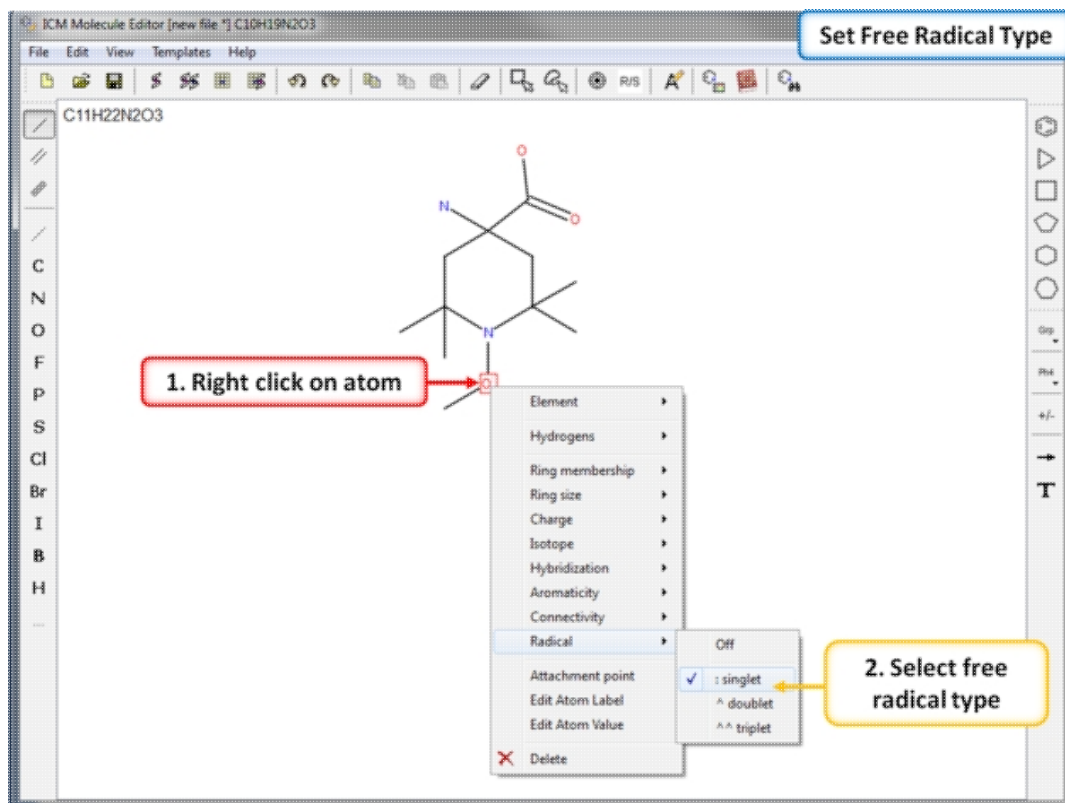

7.4.8 Adding and rotating a fragment in molecular editor by clicking-holding-and-dragging.

The Chemical Editor allows one to add bonds (click the bond button), or chemical groups (the **GRP** button). Often one needs to re-orient the added bond or fragment. In this case press on the atom to which you are going to append the bond or the fragment and **hold-and-drag** the mouse until you see added fragment rotating around the attachment point. While you keep the mouse button pressed you can **rotate** by dragging in the preferred direction.

If you add templates (the **Templates** menu, or **paste** fragments, the mechanism is somewhat different because the group is added in its default orientation. In this case you can press **Ctrl** to rotate the fragment to be able to attach the fragment in the desired orientation.

7.4.9 Property Monitor

When drawing a compound in ICM you can monitor important ADME-Tox and drug-likeness properties.

To view the monitor

- ICM Molecular Editor/View/Chemical Monitor or click on the Chemical Monitor button and a window as shown below will be displayed.

1. Click here to open chemical monitor panel

3. The properties are calculated on the fly as you sketch

2. Chemical monitor panel will be displayed here

Name	Value
1 Formula	C ₁₃ H ₁₈ O ₂
2 Smiles	C(C)(C)C(=O)C(=CC=C1)CC(C)C1
3 Name/IUPAC	2-(4-isobutyl-phenyl)-propanoic
4 InChI	InChI=1S/C13H18O2/c1-9(2)8-
5 InChIKey	HEPNEWSDXXATRW-UHFFFAOY
6 MolWeight	206.1307
7 HBA	3
8 HBD	1
9 RotB	4
10 DrugLikeness	0.958908
11 MolArea	266.78
12 MolHf	-92.8134
13 MolLogP	3.33837
14 MolLogS	-2.96525
15 MolPSA	28.6465
16 Volume	214.268
17 Chem Alerts	
18 Groups	Phenyl Carboxylic acid (Carboxyl)

The following properties are monitored.

- Chemical Formula
- SMILES string
- Name/IUPAC Name
- InChI
- InChI Key
- Molecular Weight (MolWeight)
- Number of Hydrogen Bond Acceptors (HBA)
- Number of Hydrogen Bond Donors (HBD)
- Number of Rotatable Bonds (RotB)
- DrugLikeness value Druglikeness is not based on other properties, this is separate model built using Bayesian Classifier (See: <http://www.molsoft.com/mpropdesc.html>). Normally Bayesian classifier returns either 1 or -1 (positive or negative) therefore positive values means drug-like, negative - not.
- Molecular Area (MolArea)
- Prediction model build for 'delta Hf in gas' property using public NIST database (description can be found here: <http://webbook.nist.gov>). A low dHf value means that the compound is more 'stable'.
- LogP (MolLogP)
- LogS (MolLogS)
- Polar Surface Area (PSA)
- Volume
- Chem Alert will flag any reactive group, PAINS or Bad ADME-TOX groups.
- Groups option highlights chemical groups in the sketch.

The rows in the monitor window are colored from green (good) to red (poor). You can right click on the table to copy a value or add your own prediction model.

7.4.10 Editing structure using keyboard

You can select a fragment or simply position your mouse cursor over a bond or atom and use the following keystrokes for editing:

- **Changing atom properties**
- d set/unset heavy *atom connectivity* as drawn to avoid additional branches in chemical searches. Toggle.
- r set/unset the "**in-ring**" property of *atoms*. Toggle.
- γ set/unset *atom hybridization type* (*sp1,sp2,sp3*). Toggle.
- A set *atomic* property to be **aliphatic**
- a set *atomic* property to be **aromatic**
- * (asterisk) set *atomic* property to be **any atom**
- C Carbon
- H Hydrogen
- N Nitrogen
- O Oxygen
- F Fluorine
- P Phosphorus
- S Sulfur
- I Iodine
- **Changing chemical bonds**
- 1,- (dash) **single bond**.
- 2,= (equal) **double bond**.
- 3,# (hash) **triple bond**.
- 4,: (column) **aromatic bond**.
- 0,~ (tilde) **any bond**
- **Changing R-Groups**
- Press 1 to mark an atom as R1
- Press Ctrl-1 to preserve its type and create [C;R1]
- Press Ctrl-0 to remove the mark.

7.4.11 Chemical Editing Options

Tools are provided to help editing your chemical sketch. These include buttons for selection, erasing, copy and paste.

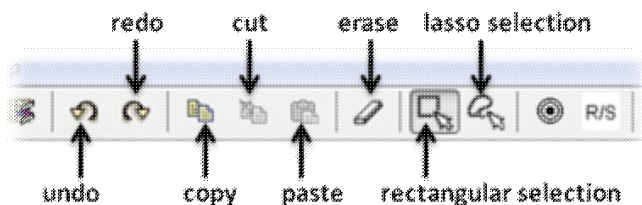

7.4.12 Paste SMILES or InChi String

To paste a SMILES string into the Molecular Editor:

- Open the Molecular Editor.
- In the Molecular Editor window select Edit/Add Smiles/InChi.
- Click on the canvas.

7.4.13 Save Chemical in Mol/RXN Format

To save the structure as a MOL or SDF file on your machine or server:

- Select File/Save As... in the Molecular Editor window
- Enter a filename and select where you wish to save the file.
- Save as type mol or rxn

7.4.14 Save to Chemical Spreadsheet

To save the chemical to a chemical spreadsheet:

- Click on one of the buttons shown below. You can append to a new table or an existing one.

append molecule to a chemical spreadsheet

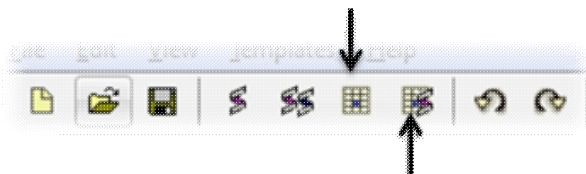

append molecule to a chemical spreadsheet
and convert to 3D

7.4.15 Save as SMILES or InChi

To save the chemical in SMILES format

- Edit/Copy as Smiles

To save the chemical in InChi format

- Open the Chemical Monitor.
- Right click on the InChi row and choose copy.

7.4.16 Convert Chemical to 3D or Generate Conformers

To convert the chemical to 3D or to generate conformers:

- Click on the buttons shown below to convert to 3D or generate conformers in the Merck Molecular Force Field (MMFF)
- The 3D chemical will be listed in the ICM workspace. If conformers are generated a table showing the conformers will be created.

Convert to 3D



Generate Conformers

7.4.17 Isis Draw Copy and Paste

Molecules drawn in ICM can be cut and pasted into ISIS-Draw and vice-versa molecules from ISIS-Draw can be cut and pasted into ICM.

To perform these functions the correct settings need to be turned on in ISIS-Draw so that the compound drawing is saved in the clipboard.

IN ISIS-DRAW - Go to Options/Settings/General/Copy Mol Rxn file to the clipboard.

Compounds drawn in ISIS Draw can be cut and pasted into the ICM Molecular Editor and into ICM tables. Compounds can be copied in ICM by:

- Right click on the compound in the chemical table and select Copy Molecule.

7.5 Chemical Search

Available in the following product(s): ICM-Chemist | ICM-Chemist-Pro | ICM-VLS

Chemical similarity searching can be used to screen a database of compounds for structural similarity to a query chemical structure. The chemical similarity search window is shown below. To access this window use the Tools/Chemical Search menu or select the button shown below.

Chemical search

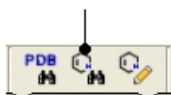

How to setup a chemical search.

1. Click here

2. Chemical search window will be displayed

7.5.1 Query Setup

To set up a query first you must have either drawn or loaded a chemical structure into ICM. Instructions for this are described in the Reading Chemical Structures and Molecular Editor sections of this manual. If for example the query molecule you want to search is in a chemical spreadsheet you can right click on chemical in the spreadsheet and

select **Query Molecule**.

At this point your query can be modified as described in the **Molecular Editor** sections of this manual. **However**, there are a number of ways to specifically modify your query and filter your search. The way to accomplish this is to right click on a bond or atom and a menu as displayed below will be displayed. The menus differ depending on whether you right click on a bond or atom.

If you wish to specify a filter at an atom.

- Right click on the atom and the menu shown below will be displayed.

The screenshot shows the ICM Chemical Search interface. The main window displays a chemical structure of a benzene ring attached to a propene chain. A red box highlights a carbon atom in the propene chain, labeled [C,R1]. A context menu is open over this atom, listing options: Element, Hydrogens, Ring membership (selected), Ring size, Charge, Isotope, Hybridization, Aromaticity, Connectivity, Attachment point, and Delete. The 'Ring membership' sub-menu is also open, showing options: Off, As Drawn R, R0, R1 (checked), R2, and R3. The interface includes a menu bar (File, Edit, View, Templates, Help), a toolbar, a left sidebar with element symbols (C, N, O, F, P, S, Cl, Br, I, B, H), and a right sidebar with 'Data Source' (Table, File, Molcart), 'Query Options' (Search type: Substructure, Max distance: 0.4, Number of matches: any, Match stereo, Ignore salt, Selected only, Maximum # of hits: 10000), and 'Results' (Count hits only, Select in source, Hide unmatched, Save results to: table, File, Molcart, result, Overwrite, Highlight match, Rotate by match, Display as grid, Store query, Append, Hide after Search, Search button). A table at the bottom has columns for FieldName, Relation, and Value. A text search box is at the bottom left.

If you wish to specify a filter at a bond.

- Right click on the bond and the menu shown below will be displayed.

The screenshot shows the ICM Chemical Search interface. The main window displays a benzene ring with a bond highlighted in red. A context menu is open over this bond, listing options: Single, Double (checked), Triple, Aromatic, Any, Stereo, Attributes, and Delete. The text "Right click on bond" is written next to the menu. The software interface includes a menu bar (File, Edit, View, Templates, Help), a toolbar, a vertical element list (C, N, O, F, P, S, Cl, Br, I, B, H), a search panel on the right with "Query Options" and "Results" sections, and a table at the bottom for search results.

FieldName	Relation	Value

To specify a particular atom type, aromatic, aliphatic or R-group at a particular atom site.

- Right click on the atom and select the "symbol" option as shown below.
- Select the desired atom type, aromatic, aliphatic or R-group and a symbol will be displayed as shown below.

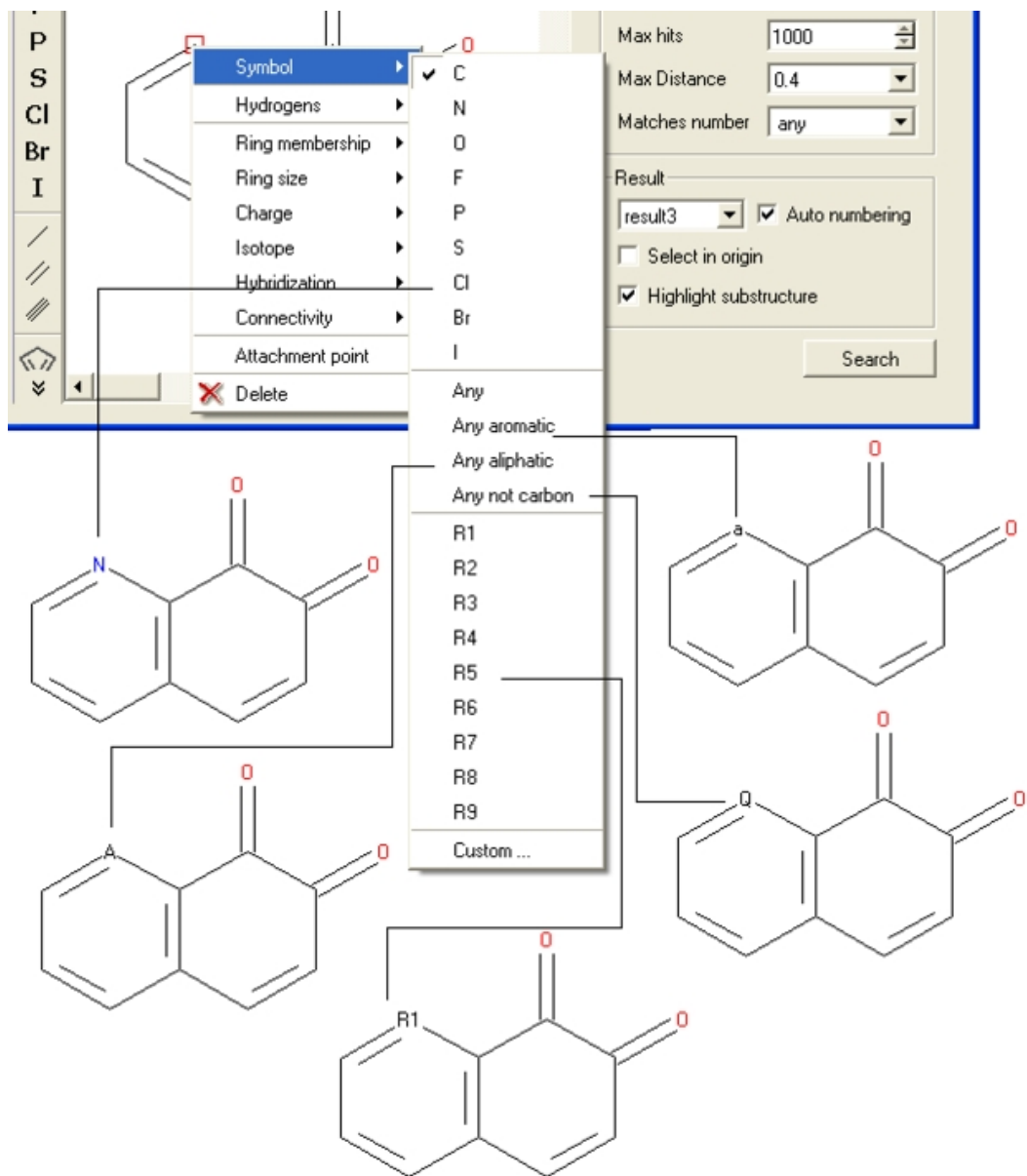

For example:

Query:

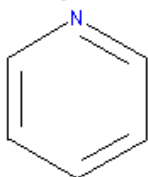

Right click atom - Symbol - N

Selection of chemical substructure search results

	1	2	3	4
0				

To specify a particular number of hydrogen atoms at a particular site:

- Right click on the atom and select the "Hydrogens" option as shown below.
- Select how many hydrogens you wish to specify and a symbol will be displayed as shown below.

The screenshot shows a software interface with a context menu open over a carbon atom in a chemical structure. The menu options include Symbol, Hydrogens, Ring membership, Ring size, Charge, Isotope, Hybridization, Connectivity, Attachment point, and Delete. The 'Hydrogens' option is highlighted, and its sub-menu is open, showing 'Off' selected. To the right, there are search parameters: Max hits (1000), Max Distance (0.4), and Matches number (any). Below these are result options: result3, Auto numbering (checked), Select in origin (unchecked), and Highlight substructure (checked). A 'Search' button is at the bottom right. Below the interface, a chemical structure of a bicyclic system is shown with a 'C_{H1}' label on a carbon atom, indicating the search criteria.

To specify the number of rings a particular atom will be a member of:

- Right click on the atom and select the "Ring membership" option as shown below.
- Select whether the atom should be part of 1, 2 or 3 rings.

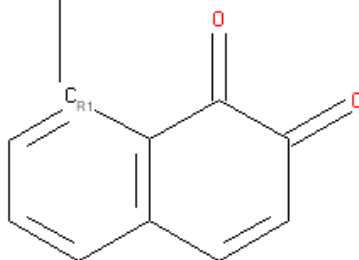
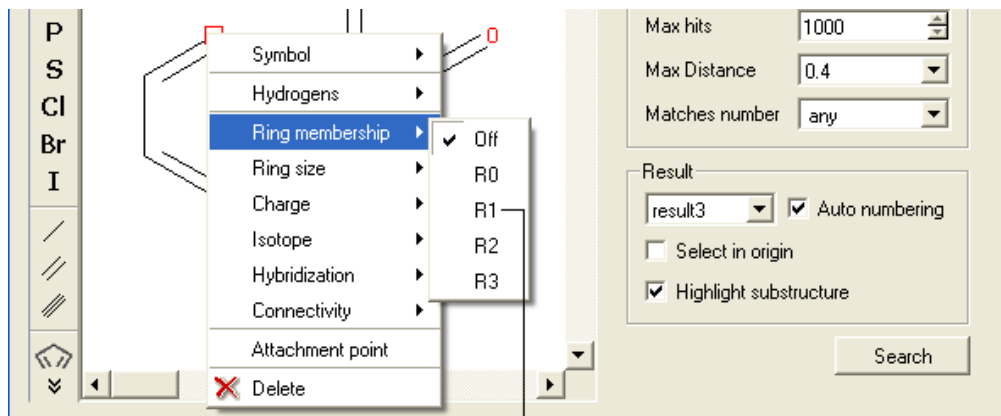

For example:

Query:

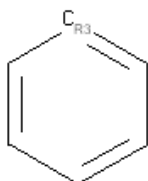

Right click atom - Ring Membership - R3

Selection of chemical substructure search results

	1	2	3	4
24				

To specify the ring size connected to an atom:

- Right click on the atom and select the "Ring size" option as shown below.
- Select the size of the ring the atom should be connected to and a symbol will be displayed as shown below.

For example:

Query:

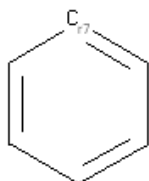

Right click atom - Ring size - R7

Selection of chemical substructure search results

	1	2	3	4
0				

To specify the charge at a particular point:

- Right click on the atom and select the "Charge" option as shown below.
- Select the desired charge and a symbol will be displayed as shown below.

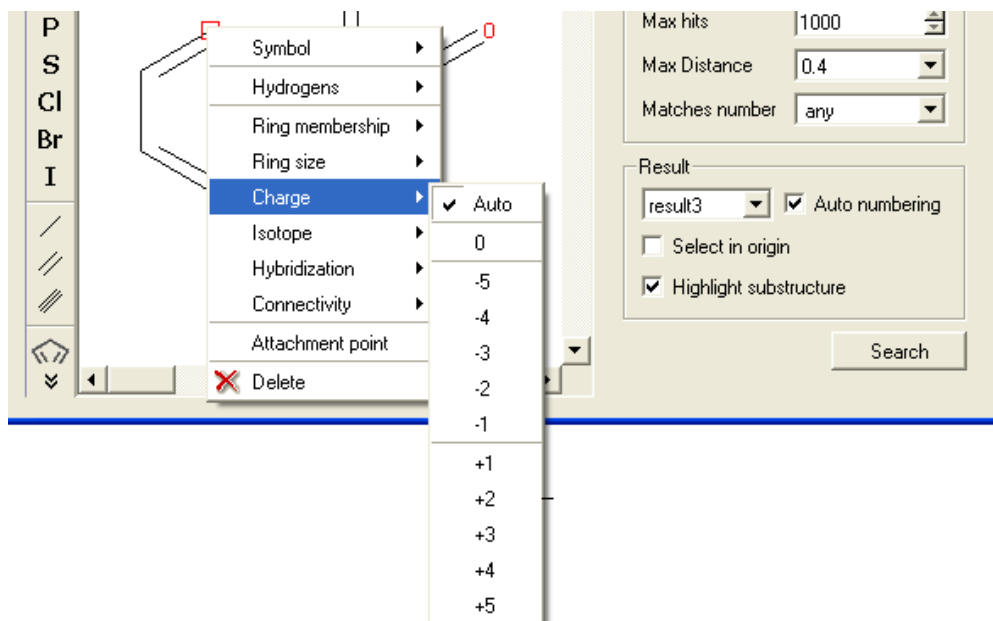

To specify an isotope at a particular atom

- Right click on the atom and select the "Isotope" option as shown below.
- Select the desired isotope from the list and a symbol as shown below will be displayed.

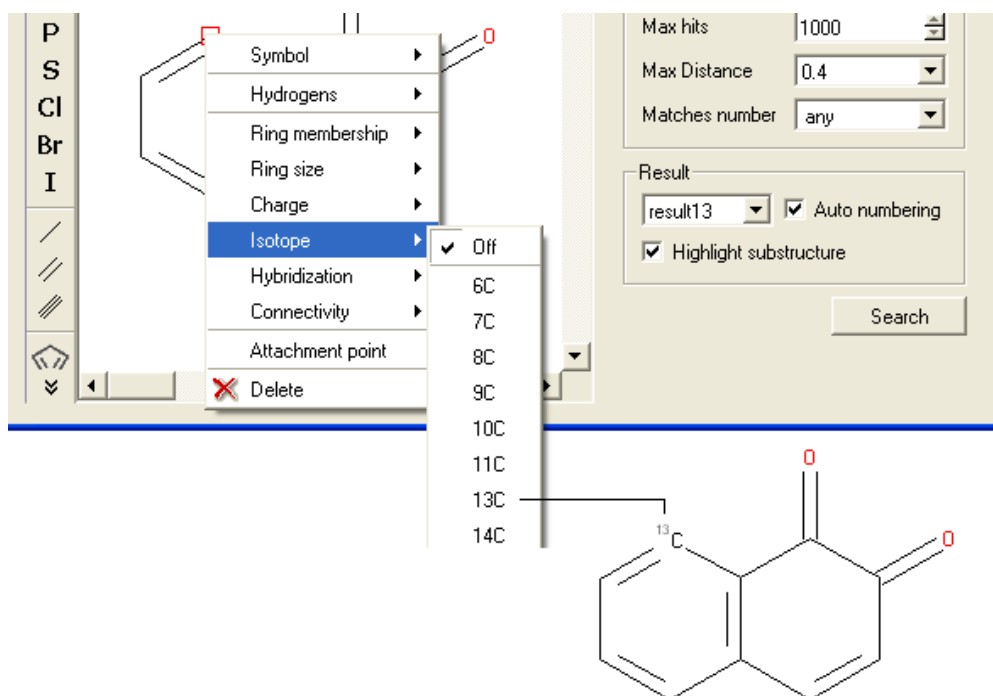

To specify the hybridization state of the atom:

- Right click on the atom and select the "Hybridization" option as shown below.
- Select the desired hybridization state and a symbol will be displayed as shown below.

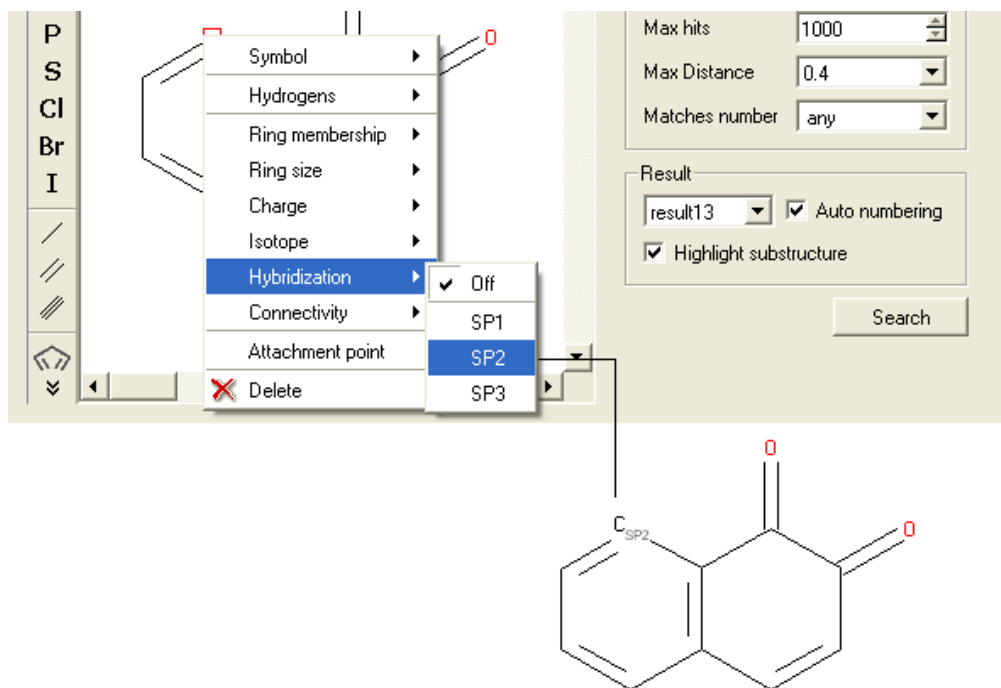

To specify the number of atoms you wish an atom to be connected to:

- Right click on the atom and select the "Connectivity" option as shown below.
- Select the number of atoms you wish the atom to be connected to and a symbol will be displayed as shown below.

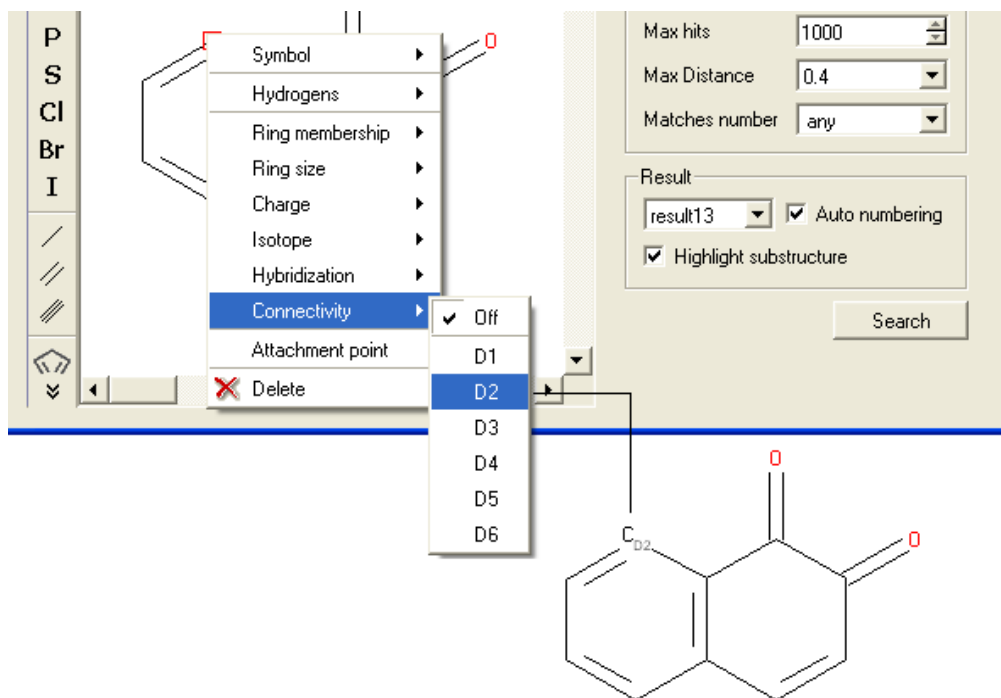

To specify an attachment point - ie the position at which substituents will be added

- Right click on the atom and select the "Attachment point" option as shown below.
- An asterisk representing the attachment point will be displayed next to the atom.

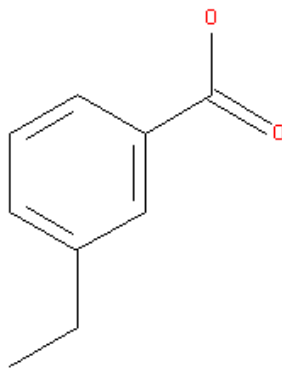

Attachment point —●*

An attachment point means that the atom can be attached to zero or more bonds to heavy atoms.

7.5.2 Filter Search

How to filter your query

To filter your query:

- Right click in the box shown below and select 'Add Condition'

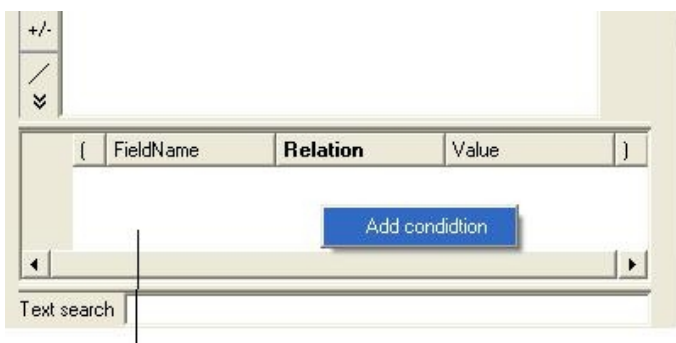

Right-click here and select Add Condition

To add conditions to your filter:

- Double click in the fields labeled "Name" and "Relation" and select the options from the drop down arrow or type in values.

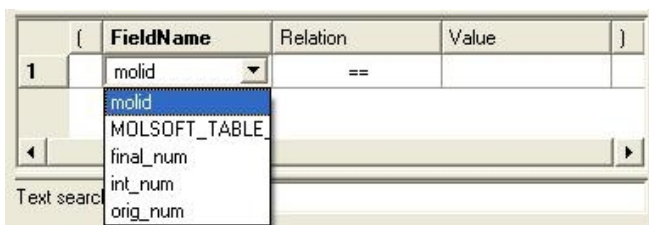

To remove a filter, right click on the filter and select 'Remove Filter'.

To exclude a fragment from your search

Click on the option **Exclude fragment list**:

- Enter the SMART string of the fragment or use the Molecular Editor option to sketch the fragment.

- Click OK and the fragment will be listed at the bottom of the chemical search window as shown below.

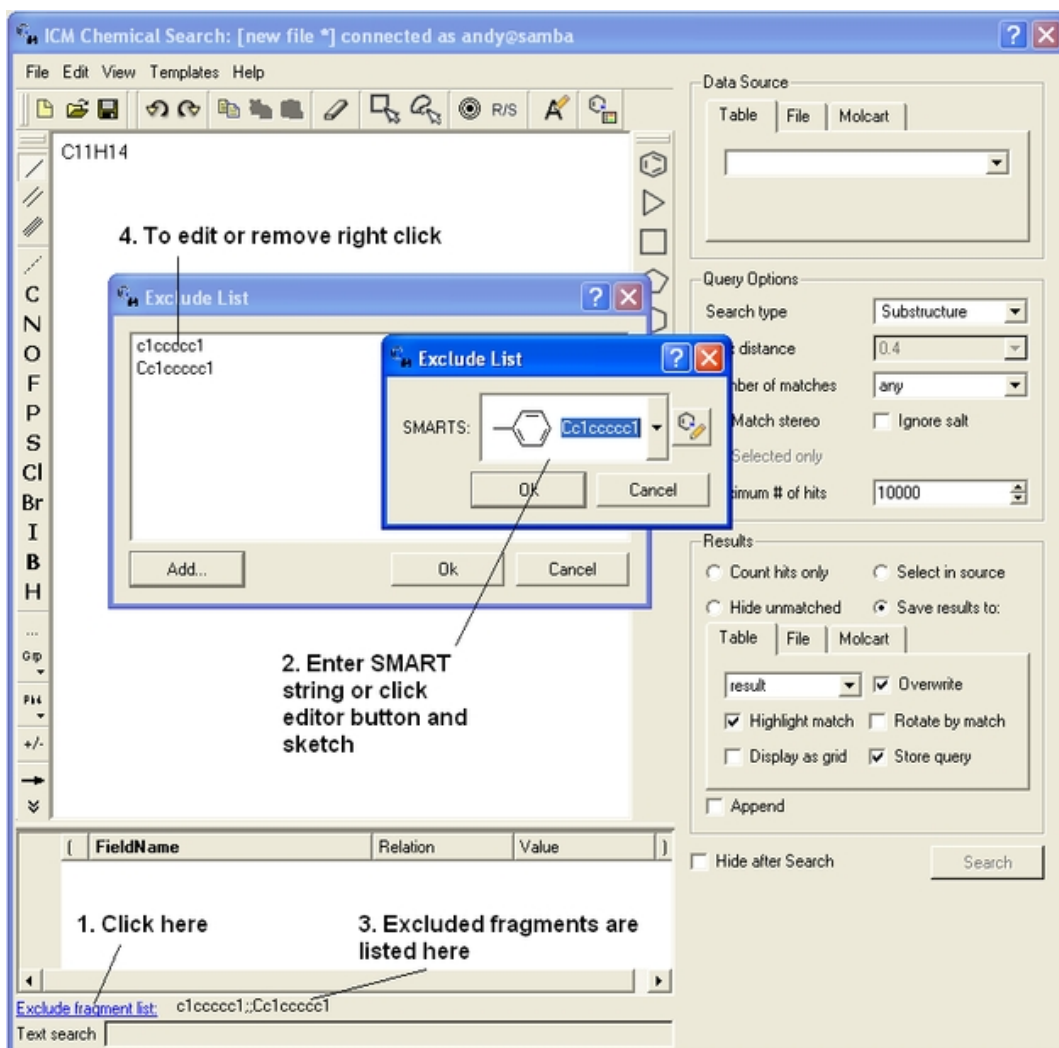

7.5.3 Query Processing

To begin processing your query first you need to decide which database to search. The options are listed in the **Data Source** section of the ICM chemical search window.

Data Source

You can either search a Table- Chemical Spreadsheet a File - Local Database or MolCart.

If you select **MolCart** you first need to setup the link to the correct database.

- Enter the Server Name in which the database is stored.
- Enter the database name.
- Enter your username and password for the server.
- You can save these details so you dont have to re-enter this information each time you use the chemical similarity search.

If you are searching a **Table**, click on the **Table** tab and then select the drop down button where the names of your currently loaded tables are stored.

If you are searching a **File** click on the **File** tab and then locate your local table database file .molt or if it is already loaded into ICM you can locate it with the drop down button.

Query Options

Now select a search type:

- Click on the drop down arrow next to the "Search Type" option in the Query Options panel.
- Select the search type you want to use.

A **substructure** search is a search whereby only the defined molecule in the query will be searched against the database. Whereas, a **FP similarity** search which stands for fingerprint search enables any fingerprint within a structure to be searched for in the database. The similarity method calculates tanimoto distance using chemical fingerprints (1. -most distant, 0. - closest). The similarity = 1. - distance.

The **Max distance** option is available for use with the FP search and the **Matches number** option is for use with the substructure search. The option you do not require based on your search method will be blanked out. A "Max distance" value of 0 means that the search will only identify matches exactly the same as the fingerprint - the default is 0.4. The "Matches number" option allows you to stipulate how many times within a structure in the database your query can be found.

Additional options include:

- Match stereo option. With this option chirality will be taken into account in substructure and similarity searches.
- Ignore salts.
- Keep ring membership.
- Search tautomers. If this option is selected ICM will use different tautomeric forms of the query chemical during the search.

If you make a selection of your query ICM can use that selection to search. How to make selections in the Molecular Editor are described here. Enter the Maximum number(#) of hits you would like returned.

Results

Before processing the query determine how you would like your results displayed in the **Results** section of the **Chemical Search** window.

Count hits only - this option will count the number of hits and display this number in a window once the searching has been completed.

Select in source - If you are searching a table you can select and highlight the query in the source table that you are searching.

Hide unmatched - Hide unmatched will hide the compounds that were not matched from view.

Save results to: - this option gives you the option to save the output results to a Table- Chemical Spreadsheet a File -Local Database or MolCart.

Append - this option will allow you to append to current table, file or Molcart database.

Search

- Click on the **Search** button to execute the search. You can choose to hide the window after the search.

7.5.4 Search a Database by Text

To search a database by text enter the text you wish to search in the **Text Search** data entry box at the bottom of the ICM Chemical Search window.

ICM Chemical Search: [new file *] Molcart not connected

File Edit View Templates Help

C11H14

Single
✓ Double
Triple
Aromatic
Any
Stereo ▶
Attributes ▶
✗ Delete

[C,R1]

Table File Molcart

Query Options

Search type Substructure

Max distance 0.4

Number of matches any

Match stereo Ignore salt

Selected only

Maximum # of hits 10000

Results

Count hits only Select in source

Hide unmatched Save results to:

Table File Molcart

result Overwrite

Highlight match Rotate by match

Display as grid Store query

Append

Hide after Search Search

Exclude fragment list

Text search

Enter text here

7.5.5 Pharmacophore Drawing and Searching

Pharmacophores can be drawn in 2D in the ICM Molecular Editor or in 3D in the Graphical Display. 2D pharmacophore sketches can be used to search chemical tables (spreadsheets) containing 2D or 3D coordinates. A 3D pharmacophore can be used to search chemical tables containing 3D coordinates only.

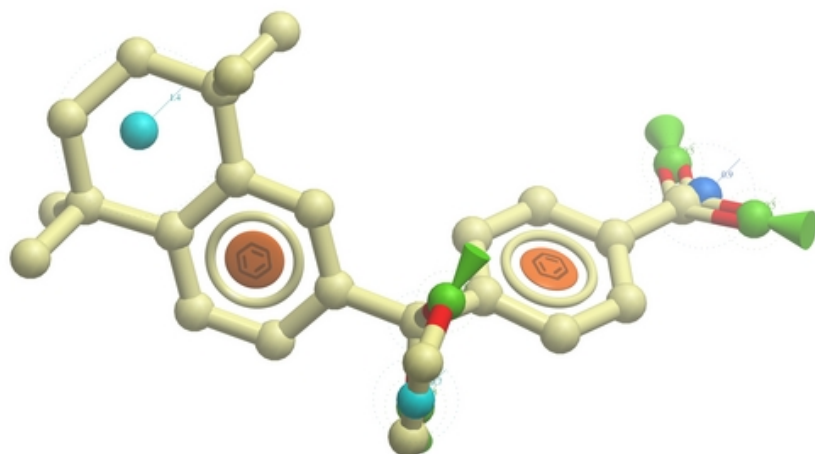

7.5.5.1 Pharmacophore Draw 2D

A 2D pharmacophore can be drawn using the ICM Molecular Editor or if you are going to use the drawing to search it is more efficient if you draw it in the Chemical Search window.

Use the distance bond button and the add pharmacophore group button to sketch the pharmacophore. The distance bond button represents the number of bonds between each pharmacophore point. You can edit the distance by right clicking on the bond and selecting edit. Other groups such as aromatic can be added using the standard molecular editor buttons.

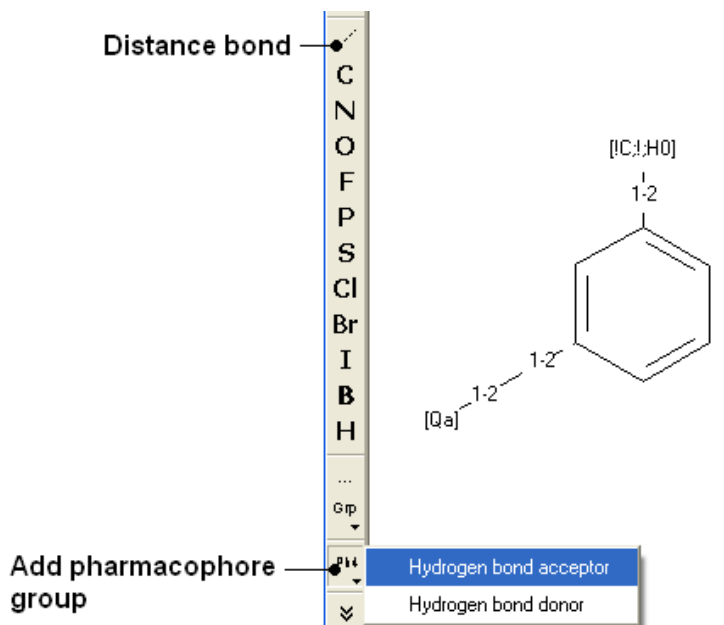

NOTE: Do not mix the 2D and 3D pharmacophore environment. For example do not edit a 3D pharmacophore in the 2D editor.

7.5.5.2 Pharmacophore Draw 3D

The easiest way to begin drawing a 3D pharmacophore is to draw a chemical in the ICM Molecular Editor which contains the key pharmacophore groups you want and then convert to 3D and extract the pharmacophore groups.

To draw a 3D pharmacophore this:

- Once the ligand is converted to 3D, right click on the ligand in the ICM Workspace.
- Select the Tools/Copy as Pharmacophore and choose the **pharm centers** option.
- The pharmacophore groups or centers will then be displayed in the graphical display and can be displayed and undisplayed in the ICM workspace.

To move a pharmacophore group:

- Use the **drag atom** button (picture of a hand. See below)
- Click on the pharmacophore group and then drag.

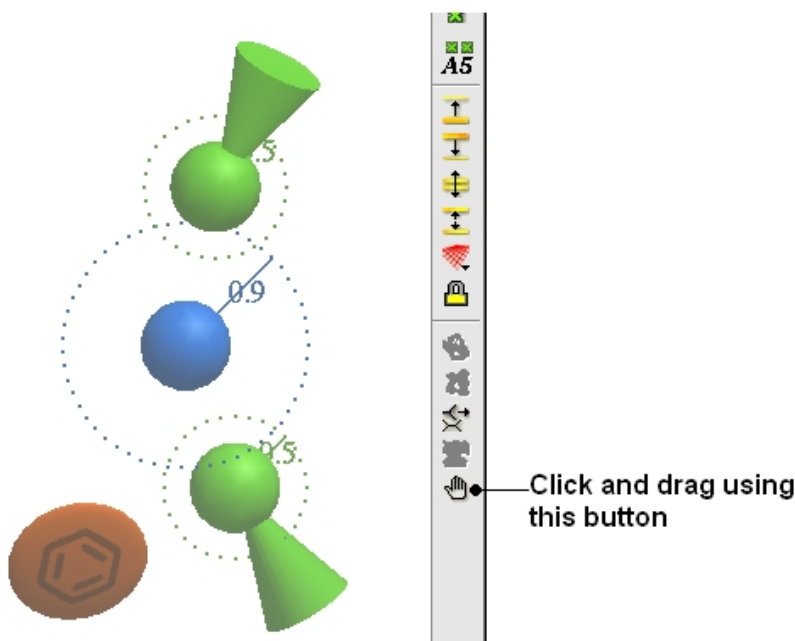

NOTE: Distances between groups can be monitored using the atom distance measurement tool. See Calculating the distance between two atoms.

To change a pharmacophore group:

- Right click on the pharmacophore group in the ICM Workspace or in the Graphical Display.
- Select **Pharmacophore/Edit Point**
- Choose the group from the drop-down list shown below.
- Enter the desired radius.

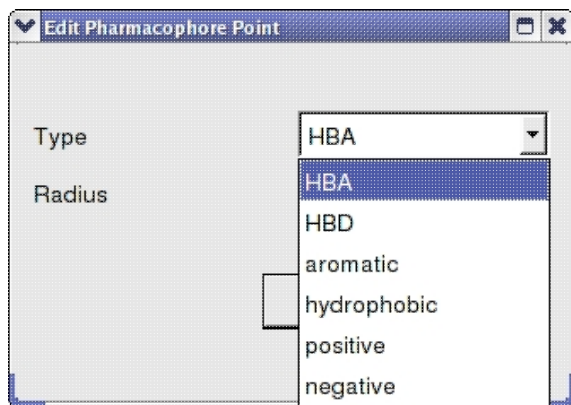

To make a new pharmacophore group:

The easiest way to make a new pharmacophore group is to clone a pre-existing one. To do this:

- Right click on the pharmacophore group in the ICM Workspace or in the Graphical Display.
- Select **Pharmacophore/Clone Point**
- You can then move the new group as described above.

To change the direction of a pharmacophore group:

- Right click on the pharmacophore group in the ICM Workspace or in the Graphical Display.
- Select **Pharmacophore/Assign Direction**
- You can then move the new group using the drag atom button described above.

To remove the direction of a pharmacophore group:

- Right click on the pharmacophore group in the ICM Workspace or in the Graphical Display.
- Select **Pharmacophore/Remove Direction**

Pharmacophore right click options

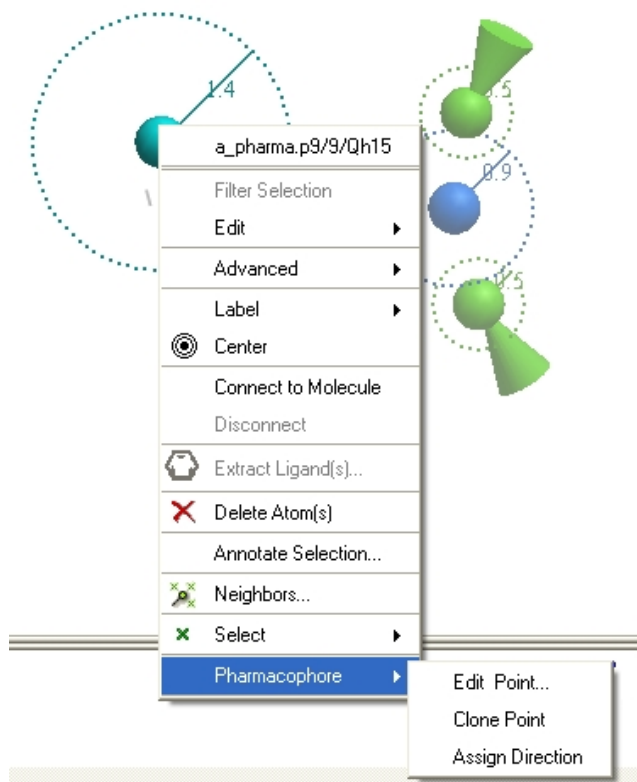

7.5.5.3 Pharmacophore Search

To perform a pharmacophore search using a 2D pharmacophore:

- Draw the 2D pharmacophore as described earlier in the Chemical Search window.
- Read in a molecular table to search or search a table in MOLCART.
- Select the chemical search options as shown below.
- Once the search has completed a new table with the results will be displayed.

Draw pharmacophore

Query Options

Database	[v]
Table	L_3D
Search Type	Substructure
Maximal # of Hits	1000
Max Distance	0.4
Number of Matches	any
<input type="checkbox"/> Match stereo	<input type="checkbox"/> Ignore Salt
<input type="checkbox"/> By Selection	<input type="checkbox"/> # Of Hits Only

Select the table you wish to search here

To perform a pharmacophore search using a 3D pharmacophore:

- Right click on the pharmacophore in the ICM Workspace
- Select **Search** Pharmacophore

- Use the drop-down button to select the table you wish to search. The table must contain 3D coordinates.

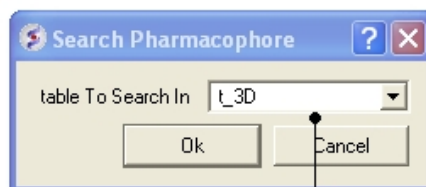
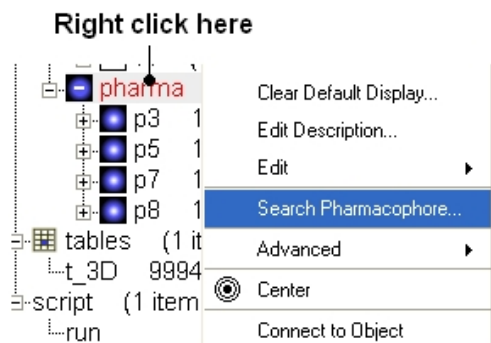

Enter name of table containing 3D coordinates

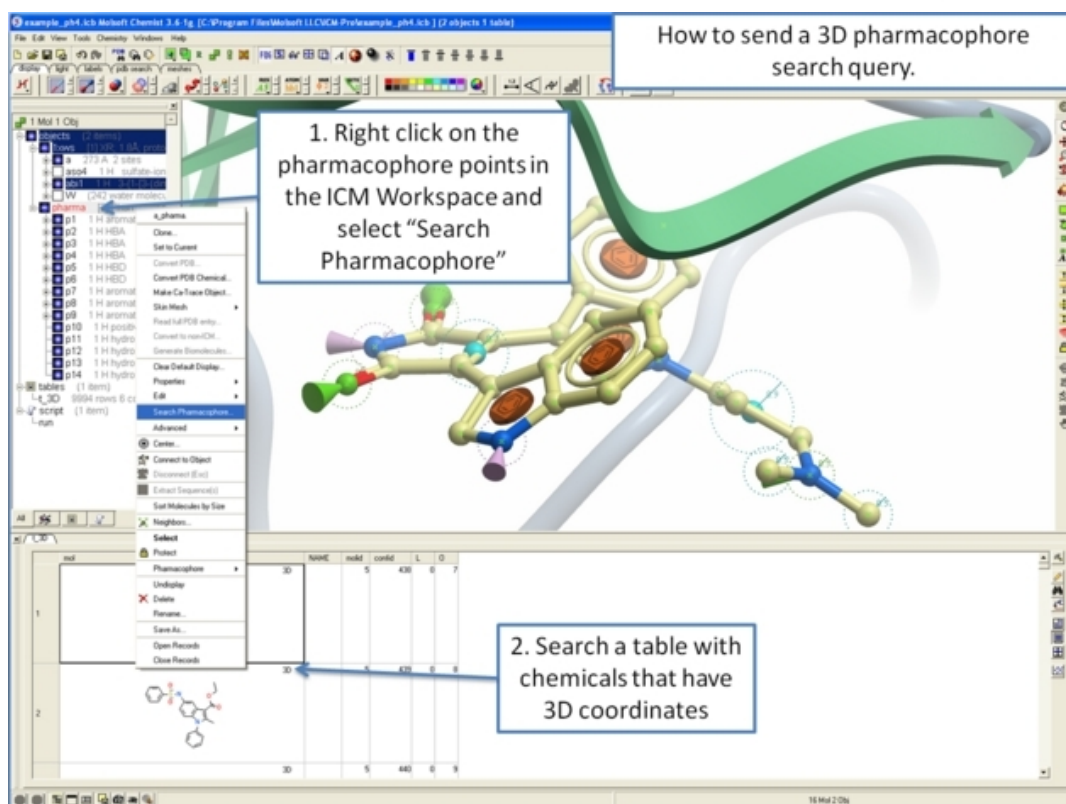

7.5.5.4 How to extract a 3D pharmacophore from a ligand.

How to extract a 3D pharmacophore from a 3D ligand.

1. File/Open 3D ligand or read in PDB
2. Right click on 3D ligand and select Tools/Copy as pharmacophore
3. Display and undisplay pharmacophore types

Chem3D Command Line:

```

i> show pharmacophore display wire m_ligand.mol
i> show pharmacophore model display stick m_ligand.mol
i> show pharmacophore display cartick m_ligand.mol
i> show pharmacophore model background rgb(125,125,125)
i>
  
```

7.5.5.5 How to color a 2D chemical sketch by pharmacophore feature.

How color a 2D chemical sketch by pharmacophore feature.

1. Right click on column header
2. Select Color Structure By/By Pharmacophore Features

Chem3D Command Line:

```

i> show pharmacophore display wire m_ligand.mol
i> show pharmacophore model display stick m_ligand.mol
i> show pharmacophore display cartick m_ligand.mol
i> show pharmacophore model background rgb(125,125,125)
i>
  
```

7.6 2D Ligand Interaction Diagram

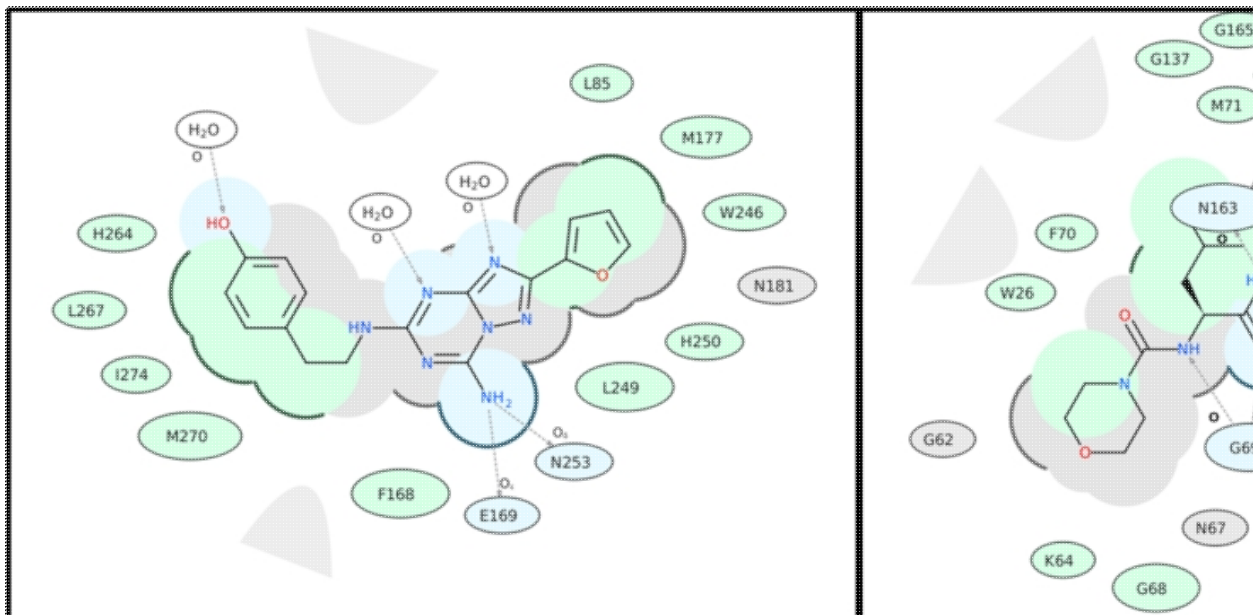

To create a 2D interaction diagram between a ligand and receptor:

- Read into ICM a PDB file containing the ligand and receptor. For correct hydrogen bond assignment you will need to convert to an ICM object.
- Right click on the ligand and choose Tools/Ligand 2D Diagram.
- A dialog box will be displayed. Select the receptor object from the drop down button and allow ICM to Auto Detect the ligand if needed.
- The **Hydrophobic Distance Cutoff** is \leq to the minimum distance between ligand and the closest atom in the residue. The **Hydrogen Bond Strength** is based on the GRAPHICS.hbondMinStrength parameter so lowering the value will identify weaker hydrogen bonds.
- An option is available to match the 2D representation to a pre-calculated one saved in a chemical table loaded into ICM.

A guide to the coloring and representation of the 2D display:

- Green shading represents hydrophobic region.
- Blue shading represents hydrogen bond acceptor.
- White dashed arrows represents hydrogen bonds.
- Grey parabolas represents accessible surface for large areas.
- Broken thick line around ligand shape indicates accessible surface.
- Size of residue ellipse represents the strength of the contact.
- 2D distance between residue label and ligand represents proximity.
- Covalently bound residue represented with thick black line around ellipse. (C25 in the picture above)

To edit the 2D image (e.g. rotate a group):

- Right click on the image and choose Edit Molecule and edit using the Molecular Editor.

To save the 2D interaction diagram to an image file:

- Right click on the image and choose Save Export/Molecular Image

7.7 Generating Chemical Fragments

Available in the following product(s): ICM-Chemist | ICM-Chemist-Pro | ICM-VLS

Chemicals displayed in an ICM Molecular Table can be split into fragments. This is useful for generating a series of R-groups to be added to a scaffold (See section describing reactions).

To generate fragments:

- Select the column or row(s) you wish to generate the fragment from.
- Right click on the "mol" column header and select "Split Into Fragments".
- A new table of chemical fragments will be displayed. Each fragment is assigned an attachment point which is flagged with an asterisk (*).

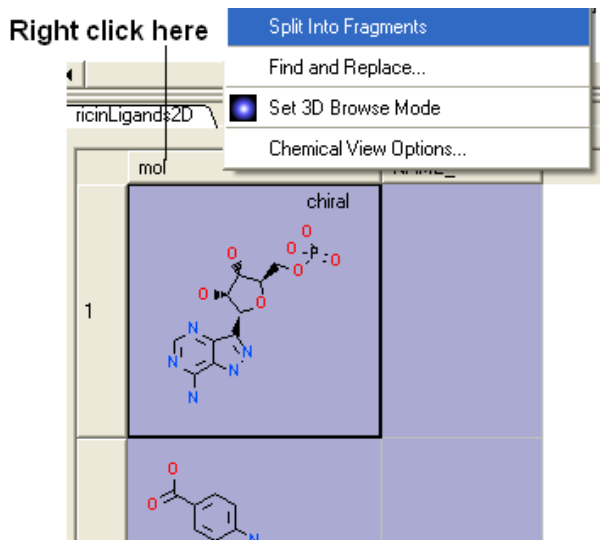

New table is generated containing fragments

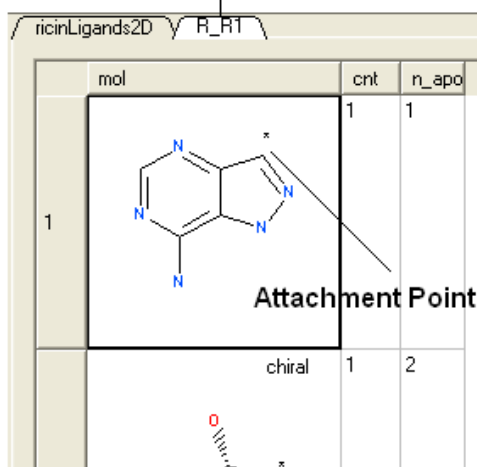

7.8 Find Bioisostere

|Bioisostere Webinar|

In drug design **bioisosteres** can be used to reduce toxicity, change bioavailability, alter metabolism and change activity of lead compound. Bioisosteres are chemical substituents with similar chemical or physical properties which produce broadly similar biological properties to another chemical compound.

7.8.1 2D Bioisostere

To find 2D Bioisosteres:

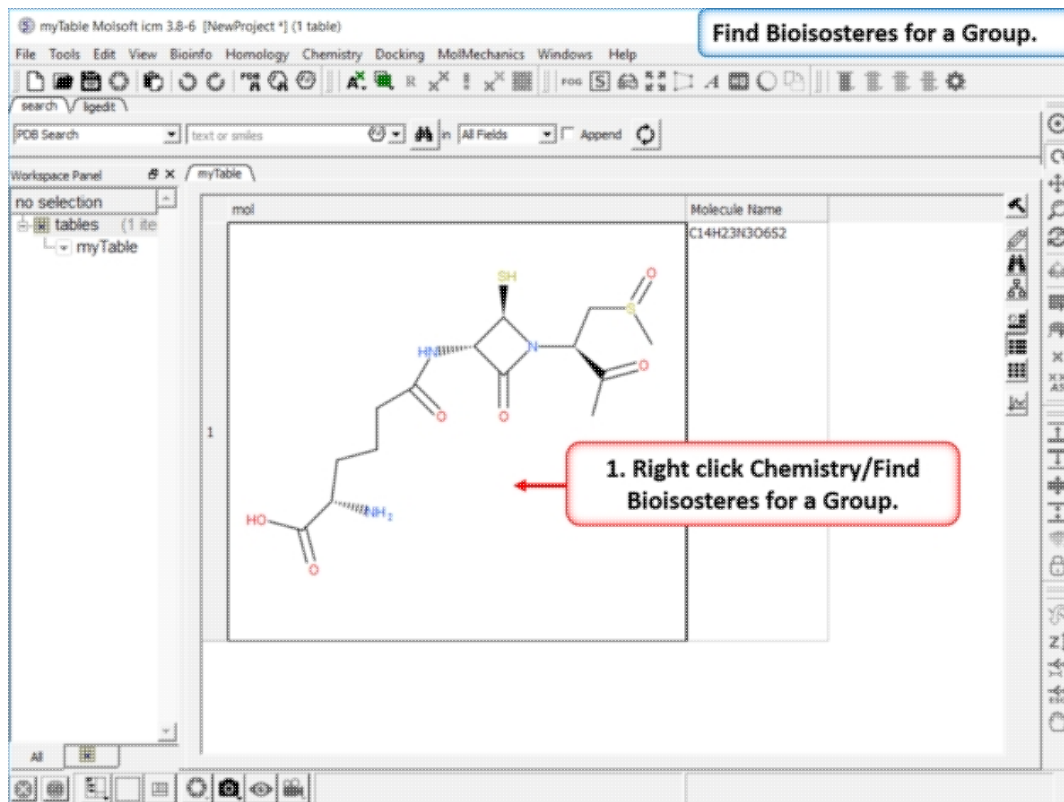

Step 1: Read in a chemical into a chemical table. Right click Chemistry/Find Bioisosteres for a Group.

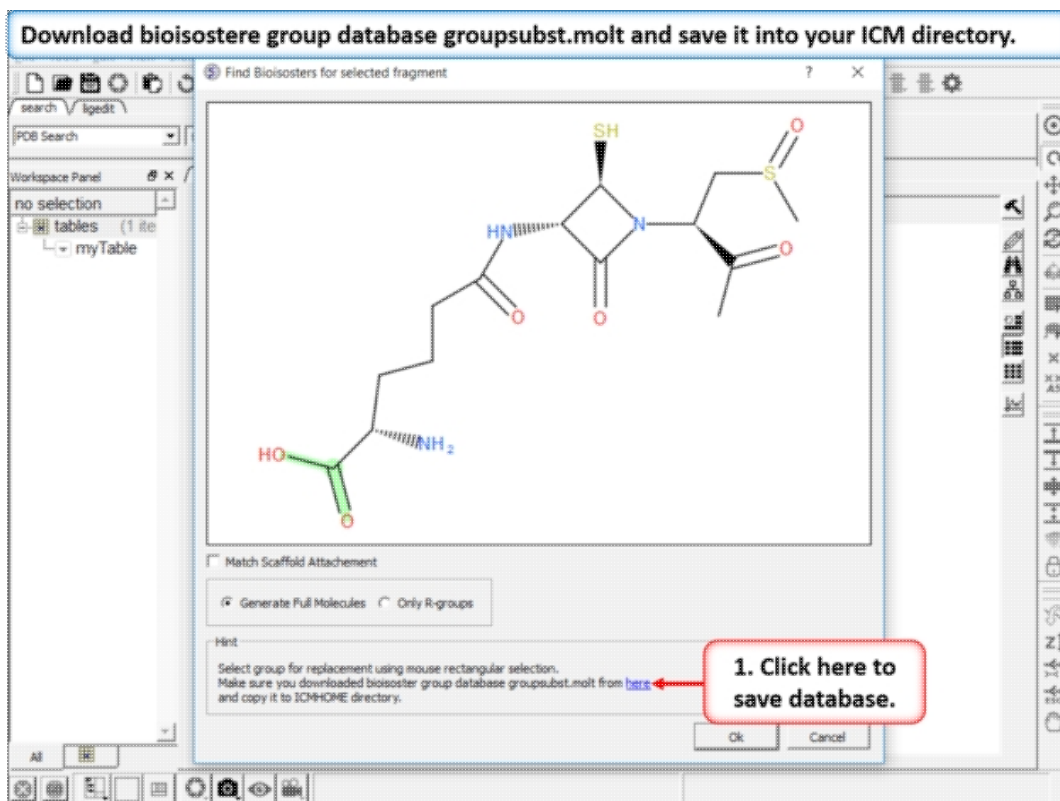

Step 2: Download Database If you do not see this link it means you already have the database in your ICM directory. If you do not have it - download bioisostere group database groupsubst.molt and save it into your ICM directory. There is a link at the bottom of the dialog window which will direct you to the correct place to download.

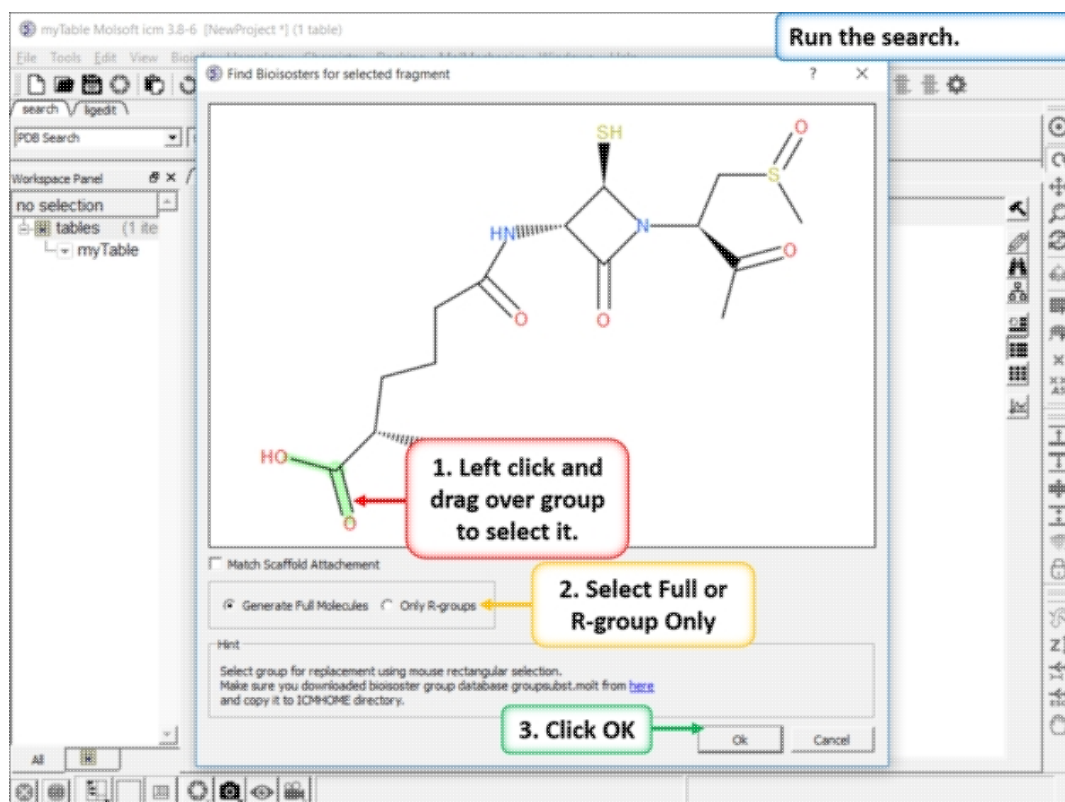

Step 3: Setup the Search

- Select the tab for 2D Database at the top of the dialog window.
- Left click and drag over the group you wish to find a bioisostere for.
- Select if you want to "Match Scaffold Attachment". It matches the attachment atom from the R-group which you're trying to substitute with the the database. In this example the attachment is C³ (SP³ Hybridized), so if you select this option it will only return hits where scaffold attachment column contains C³.
- Select if you want to generate Full Scaffold or just show the R-group.
- Click OK to run the search.

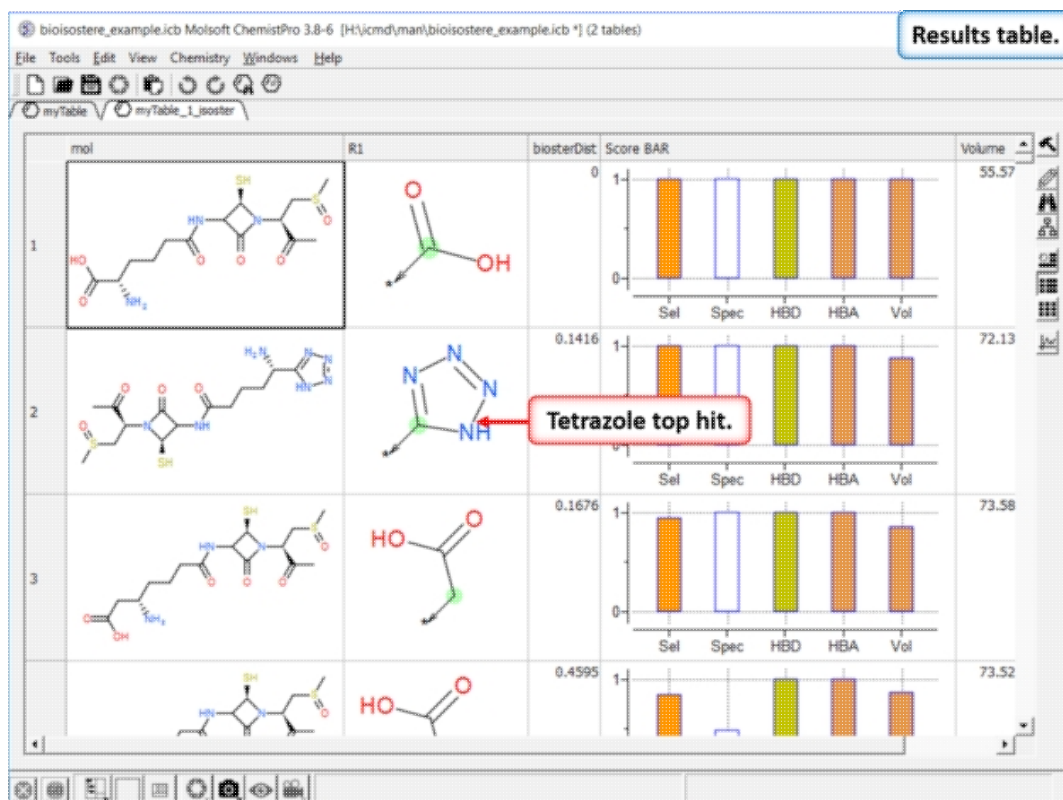

Step 4: Results Table In this example we find tetrazole which is a classic isostere of carboxylic acid. The data in the columns represent:

- **Mol** is the query chemical with the bioisostere attached.
- **R1** is the bioisostere.
- **biosterDist** Bioisoster \hat{a} distance' is calculated on the basis of five terms, two are knowledge-based and three are physicochemical. They are also reflected by the corresponding bars in the column Score BAR.
- **Score BAR**: For the bar display the terms are transformed into 0-1 range so that 1 corresponds to best match/identity.
- **Sel** - selectivity, as estimated from frequency of replacement of query R- group by a retrieved substituent relative to total number of cases where this substituent replaces any -R group in the database
- **Spec** - specificity, as estimated by the difference in activity between a database compound with a retrieved substituent and least active example of a different substituent (on the same scaffold and target) in the database
- **HBD** - factor reflecting difference in the number of HB donor functionalities of the retrieved substituent and query -R group
- **HBA** - factor reflecting difference in the number of HB acceptor functionalities of the retrieved substituent and query -R group
- **Vol** - factor reflecting difference in volume of the retrieved substituent and query -R group

- **scfldAttach** indicates the atom(s) and it's hybridization in the original group attachment. It can be used to filter solutions in the query.

If you double click on a row in the table it will show specific examples of a particular substitution from ChEMBL.

7.8.2 3D Bioisostere

The receptor/ligand complex structures from the PDB contains relevant (bioactive) 3D conformation and the environment of the isosteric moieties. This can be used to find 3D bioisosteres. You can watch a [Bioisostere Webinar](#) which explains how the 3D database was constructed.

To find 3D Bioisosteres:

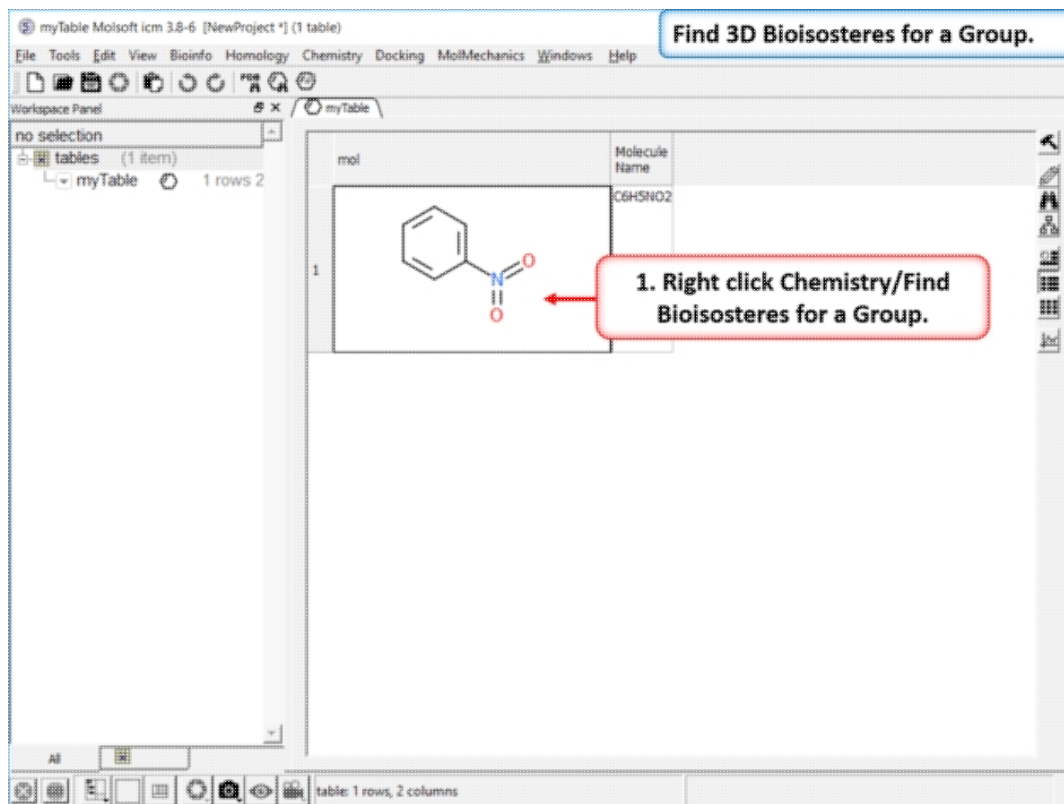

The screenshot shows the myTable software interface. At the top right, a blue box contains the text "Find 3D Bioisosteres for a Group." The main workspace displays a table with the following content:

mol	Molecule Name
1	C6H5NO2

The cell containing "1" in the first column shows a chemical structure of nitrobenzene. A red callout box with a white background and a red border points to the "Chemistry" menu option in the top toolbar, containing the text: "1. Right click Chemistry/Find Bioisosteres for a Group." The status bar at the bottom indicates "table: 1 rows, 2 columns".

Step 1: Read in a chemical into a chemical table. Right click Chemistry/Find Bioisosteres for a Group.

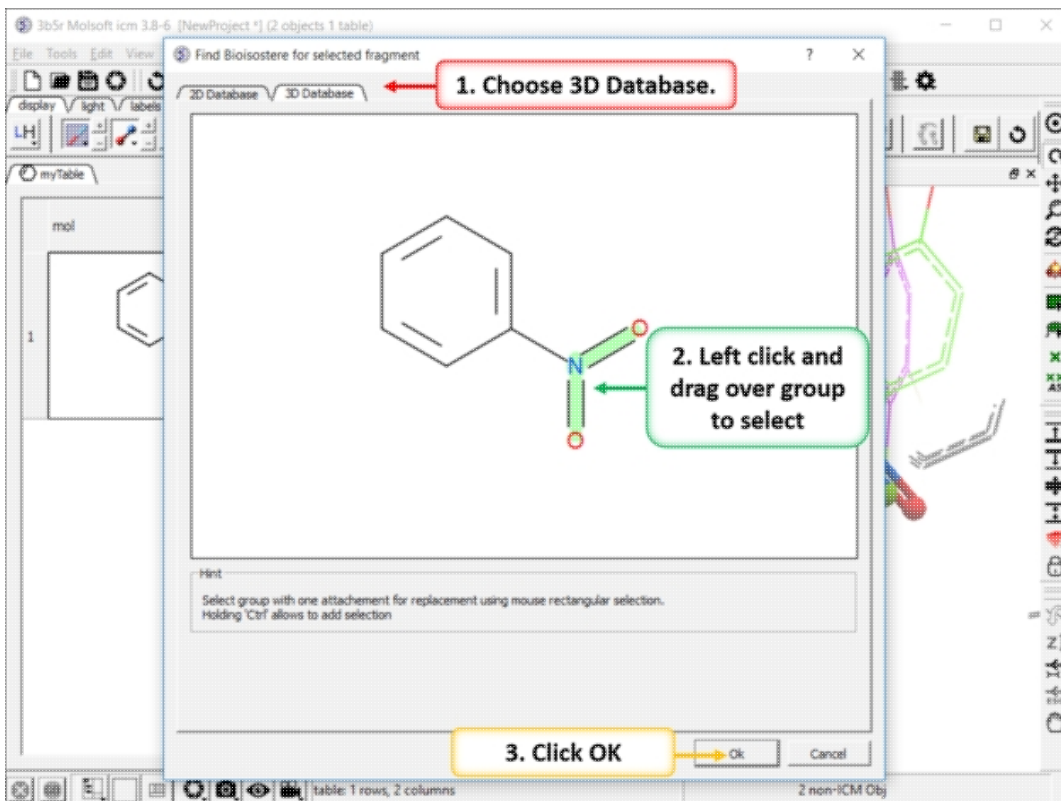

Step 2: Left click and drag over the group you wish to find a 3D bioisostere for and then click OK.

	Npairs	Npoc	R1	Freq	sel1	sel2
1	56	19	Cl	4999	4qo7a.a36v/803/n22,o23,o24	4r68a.aw31/803/C123
2	57	15	C	15884	3b5bb.bndn/265/n5,o51,o52	2ftox.xtmp/265/c5m
3	44	11	COO-	3374	1eoca.b4nc/999/n9,o10,o11	1eoba.bdhb/999/c,o1,o2
4	38	11	F	4422	3bhla.andu/265/n5,o51,o52	1ttsa.a2/265:266/f5

Step 3: The results table will be displayed the nPocs (number of pockets) column is a good indicator of a good bioisostere. As this is the number of times this replacement is seen in the PDB.

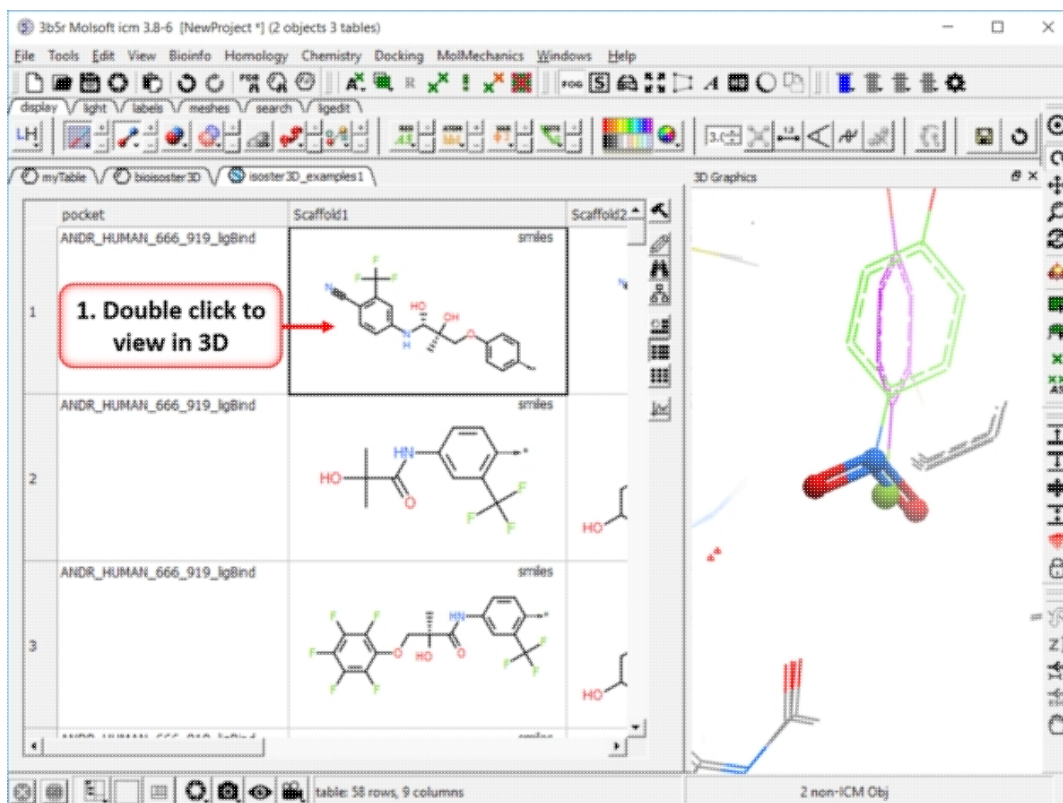

Step 4: Click on any of the hits to view specific pair examples in 3D.

7.9 Molcart

Available in the following product(s): MolCart

Molcart is an enterprise wide chemical management system. Compound databases of any size can be stored in MolCart and analyzed and searched using ICM cheminformatic tools.

7.9.1 Molcart Installation

In order to run MolCart it is necessary to install the Free Open Source MySQL database on your machine. Please see your systems administrator or see <http://dev.mysql.com/downloads/>

Linux Installation

MySQL: Check if mysql daemon is running :

```
/etc/init.d/mysql status
```

If you see that the MYSQL service is unused (not running), you need to start the mysql daemon. Become root and do the following:

```
/etc/init.d/mysql start
```

Download and install Molcart files.

The MolCart package is a self-extracting executable file.

Installation Instructions:

- Download the MolCart file (`molcart-version-platform.sh`) from the Molsoft website.
- Type in a shell window: `./molcart-version-platform.sh -p=THE_PATH_YOU_WANT_TO_DOWNLOAD` (NOTE: You must be logged in as 'root' to install the 'molcart-version-platform.sh' to '/usr/molcart-version-platform')
- The following question will be displayed: Do you want to install the molcart-1.6-6 to "/usr/molcart-1.6-6" now? (y/n) [y]
- Answer YES and the unpacking process will begin
- You will now be prompted for a password.
- Select which default databases you wish to install.
- Make a note of the HOSTNAME, DATABASE NAME and USER NAME
- MolCart is now fully installed.

Mac Installation

System requirements: * Mac OS 10.3 * MySQL server for Mac OS 10.3

To install Molcart on the Mac just run this:

```
sudo /some/path/molcart-1.6-6-darwin.sh
```

7.9.2 Molcart Getting Started

To start Molcart:

Tools/Connect Molcart

Once you have activated MolCart the loaded databases and users will be shown in the ICM Workspace as shown below.



All the records and fields contained within each database can be viewed by expanding the tree structure in the ICM Workspace.

7.9.3 Creating Databases and Importing Data

To make a new database:

- Right click on the top of the MolCart tree and then choose **New Database**

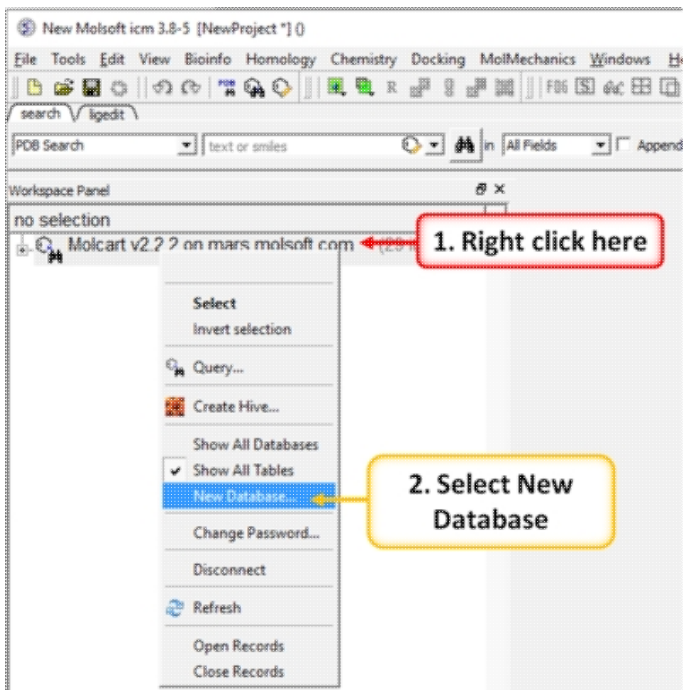

To upload SDF, csv, SMILES or MOL files or an ICM table:

- Right click on the database where you wish to add the file.
- Select Import.

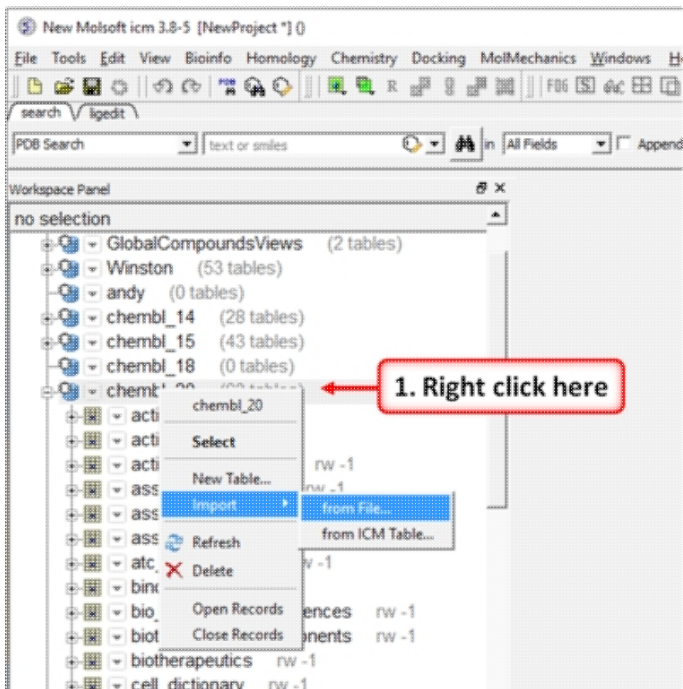

7.9.4 Molcart Search

How to search the databases contained within MolCart

Click on the button shown below.



MolCart and Chemical Search Tools

To begin processing your query first you need to decide which database to search. The options are listed in the "Data Source" section of the ICM chemical search window.

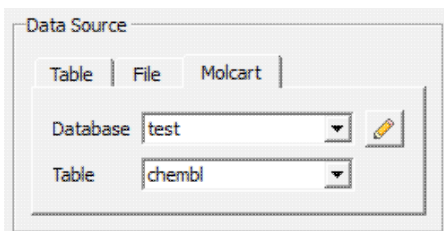

You can either search a local table (molecular table) or you can search MolCart.

If you select MolCart you first need to setup the link to the correct database - described earlier. Click on the button shown above (yellow pencil) and the Connect to Molcart window will be displayed as shown below.

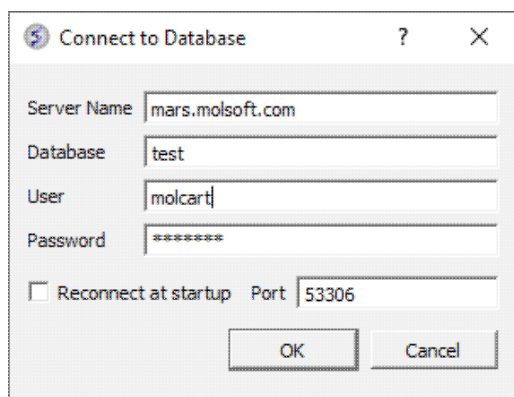

- Enter the Server Name in which the database is stored.
- Enter the database name.
- Enter your username and password for the server.
- You can save these details so you don't have to re-enter this information each time you use the chemical similarity search.

See the Chemical Search section of this manual on the many different search procedures.

How to perform a text search

To perform a text search on one of the databases contained within Molcart you first need to index the text within the database and then search using the query option.

To make the database index, see text and picture below:

- Expand the tree of the database in the ICM Workspace.
- Select the column headers you wish to search which contain Full Text or Partial Text (the data type for each column is listed next to the column name). Multiple column headers can be selected by clicking and holding down the CTRL key. A range of column headers can be selected by holding down the shift key and clicking to

select.

- Next, right click and select Create Index.
- Select 'Full Text' and you will notice an additional header in the ICM Workspace called 'indices'. The value in the items category represents the number of columns you have chosen to text search.

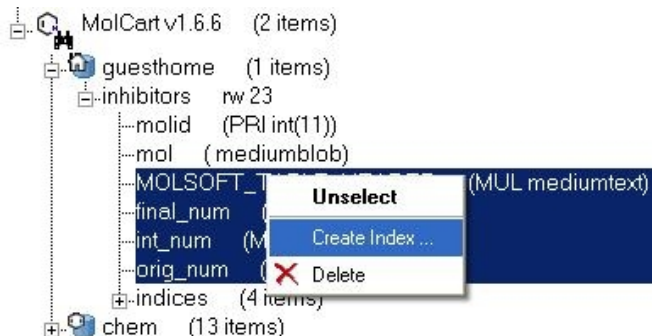

To perform the text search:

- Right click on the database name in the ICM Workspace.
- Select 'Query' as shown below.

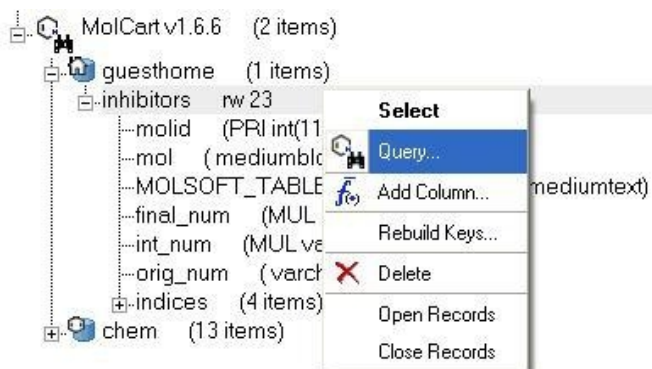

The ICM Chemical Search query window will be displayed as shown below. Type your query text in the space provided and hit the enter key or click on the search button.

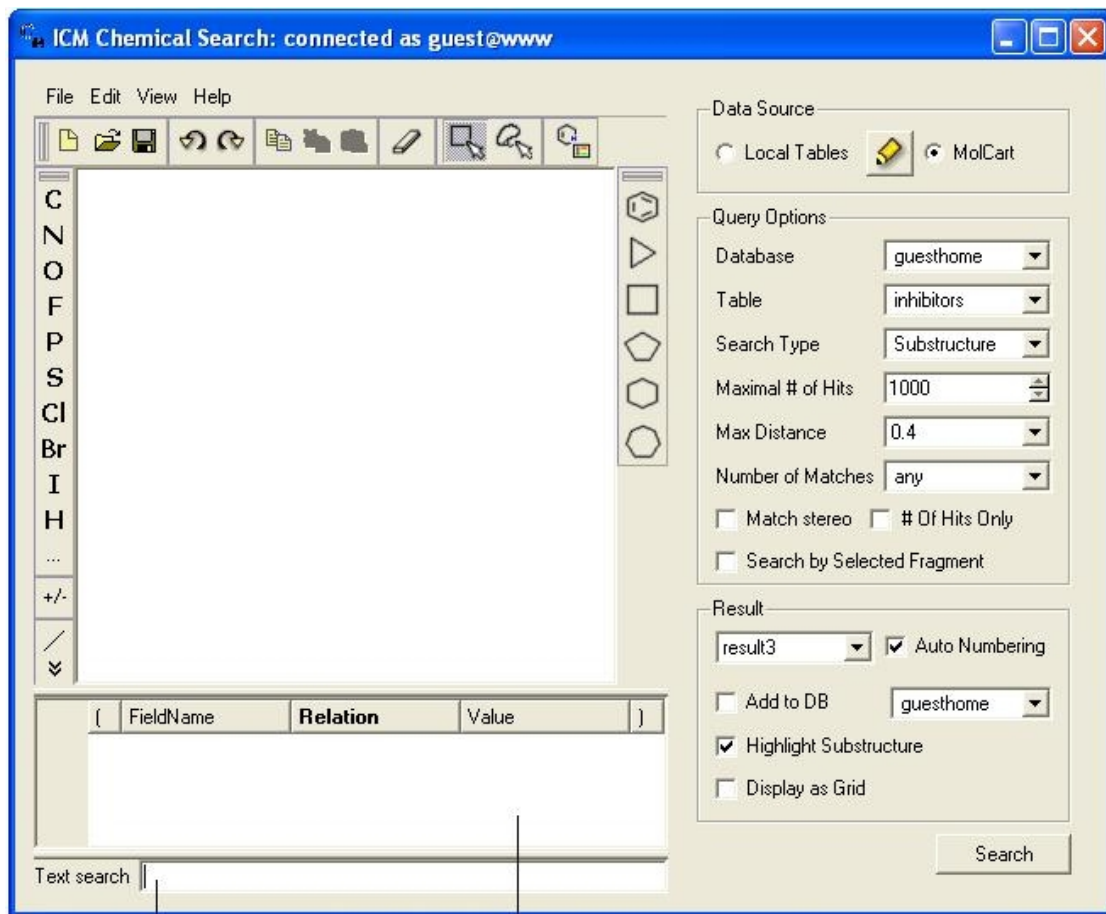

Type text search query here Filter your search here

How to add conditions to your query

- Right click in the box shown below and select 'Add Condition'. You can add as many conditions as you like.

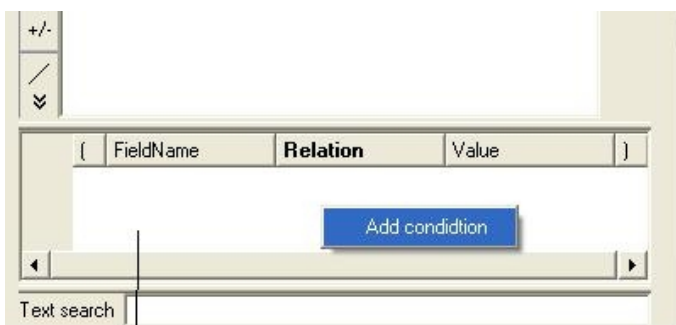

Right-click here and select Add Condition

- Double click in the fields labeled "Name" and "Relation" and select the options from the drop down arrow or type in values.

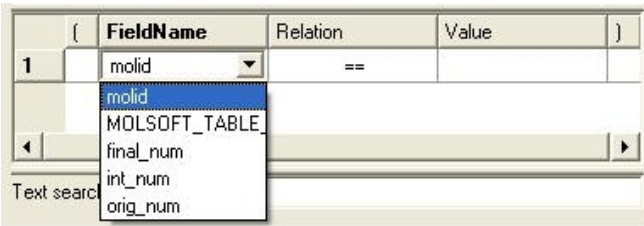

To remove a condition, right click on the filter and select 'Remove Filter'.

7.9.5 Molcart Administration

Edit Password

- Right click on the MolCart header in the ICM Workspace and select Change Password.

Add a New MolCart User - Root Only

- Right click on the User Section of MolCart in the ICM Workspace as shown below.



- Select the New User Option.
- Add new username and password in the data entry box.
- New user will be displayed in the ICM Workspace.

Edit User Privileges - Root Only

- Right click on the user in the ICM Workspace.
- Select Edit Privileges and a data entry box as shown below will be displayed.



- Select the database name.
- Edit the privileges by checking or unchecking the appropriate boxes.

Add a New Database

- Right click on the MolCart Header in the ICM Workspace as shown below.

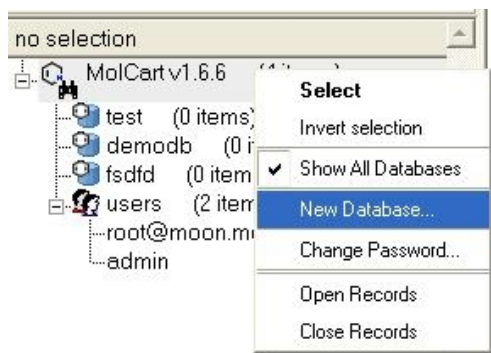

- Select the New Database option.
- Enter a unique name for your new database.
- The new database name will appear in the ICM Workspace.
- Now you need to add data to your new database (See Instructions Below).

Add New Data to Database

- Right click on the database name in the ICM Workspace as shown below.



- Select New Table.
- Select either Import from SD file or Import from ICM table.
- Select the appropriate file and the records structure of your sdf or ICM table will be displayed as shown below.

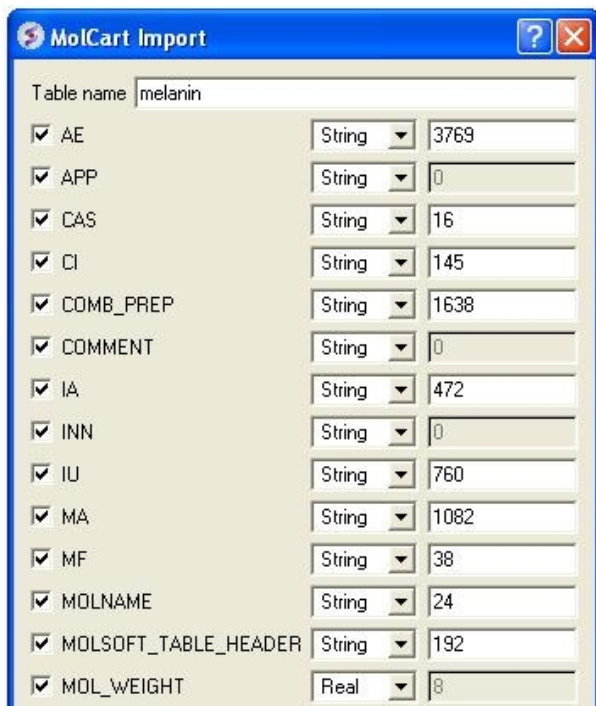

- The database name can be changed at this point and the fields contained within the database can be altered. Certain fields can be excluded by checking the boxes - this will help in minimizing the size of a database. Caution must be taken if you want to change the field type or length.
- Click OK and your sdf file or ICM table will be added to the database. This can be seen by expanding the tree structure in the ICM Workspace.

Delete a Database or User

- Right click on either the database or user in the ICM Workspace.
- Select Delete.

7.10 Calculate Properties

Available in the following product(s): ICM-Chemist | ICM-Chemist-Pro | ICM-VLS

| Video |

To calculate chemical properties for compounds within a chemical table:

- Read in the chemical table.
- Select **Chemistry/Calculate Properties** and a window as shown below will be displayed.
- **Arguments** - usually the column with the chemical structure is called mol. If this is not the case click on the drop down button and select the correct column.
- **New column location** - select where you would like to insert the new columns.
- **New column name** - This option is usually greyed out but the column name will be the same as the property name.
- Select the properties you wish to calculate using the 'tick' check boxes.
- Click OK and the properties will be added as new columns in the chemical table.

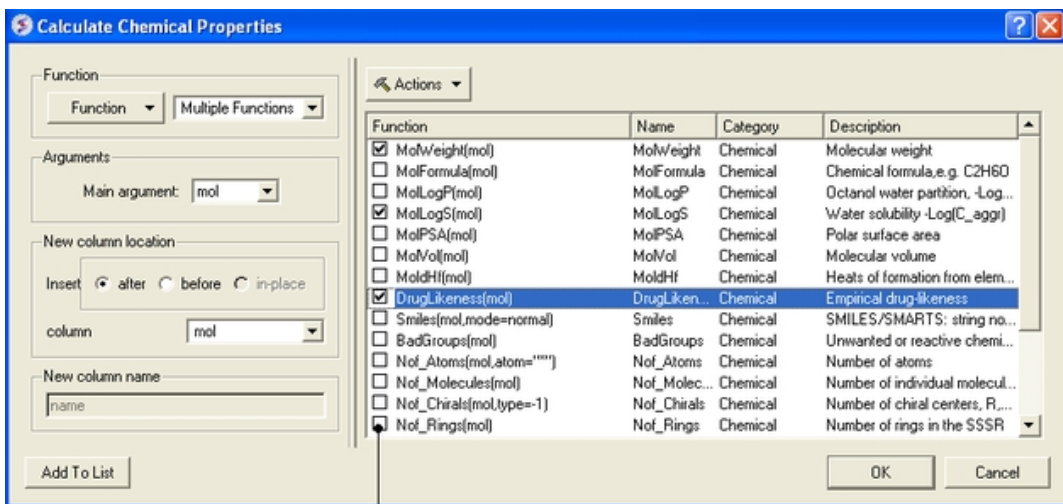

Select properties here

Actions Button Helps with Selections

If you click on the drop down button labeled **Actions** you will see 3 selection options:

- Select All properties.
- Uncheck selected options.
- Remove unchecked.

7.10.1 Number of Atoms

You can calculate the Number of Atoms using:

- Chemistry/Calculate Properties
- Choose the Function Chemical from the drop down list and then Nof_Atoms.
- Add the SMARTS string for the atoms you are trying to count (e.g. sp3 : [*;^3] halogen : X or [F,Cl,Br,I])

Nof SP3 example:

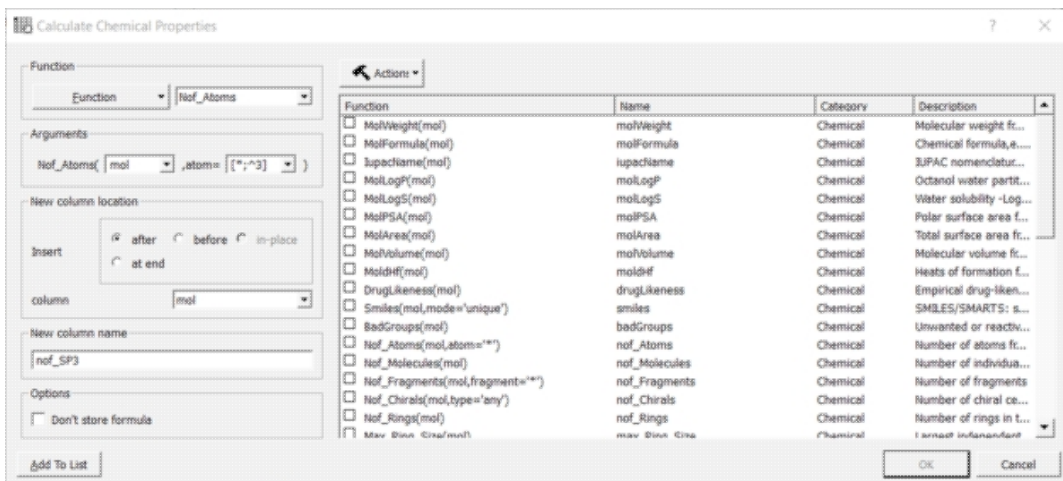

7.10.2 ToxScore

Available in the following product(s): ICM-Chemist | ICM-Chemist-Pro
| ICM-VLS

The **ToxScore** gives a prediction for how reactive or toxic a chemical is.

How the ToxScore is Calculated

Around 1000 SMARTS strings associated with toxicity/reactivity were collected from various sources. They were assigned demerit score based on their perceived toxicity and frequency of appearance in approved drugs. The toxscore of any compound was calculated by summing up all the matching SMARTS strings. A toxscore ≥ 1 , indicates likely toxicity based on substructure match.

How to Calculate ToxScore

- Read into ICM an SDF file. A chemical spreadsheet will be displayed in the GUI.
- insert a column into the chemical spreadsheet. Right click on a column header > choose insert column > choose the chemical function > select Tox Score.
- A column containing a Tox Score and Tox Names will be displayed.

7.11 Standardize Table

Available in the following product(s): ICM-Chemist | ICM-Chemist-Pro
| ICM-VLS

NOTE: Before standardizing a chemical you may want to make a copy of the original so you do not lose any information. You can do this by right clicking on the name tab of the table and selecting **clone** or **save as**.

To remove salts, explicit hydrogens and standardize groups in a chemical table:

- Chemistry/Standardize
- Select the table from the drop-down list. This will also work for selections made on the table.
- Select option - Remove Salts, Keep Salt Info in Extra Column (NOTE: option available in 3.7-2b and higher), Remove Explicit Hydrogens or Standardize Groups
- Click OK.

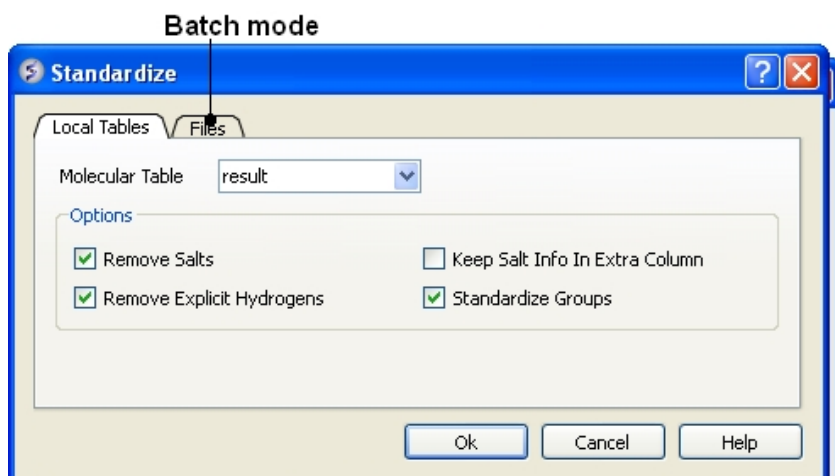

Standardize chemical groups will apply rules from ICMHOME/CHEMNORMRULES.tab For example some chemical groups may have different representations e.g. [N+] (=O)O versus N(=O)=O

To run in batch mode:

- Chemistry/Standardize
- Select the **Files** tab
- Enter the path and name of the sdf file you wish to standardize or use the browse button.
- Enter the path and name of the output file or use the browse button.

To remove a salt from an individual row in a chemical table:

- Select the row or rows.
- Right click - Chemistry/Remove Salt (Selected Row)

7.12 Annotate By Substructure

Available in the following product(s): ICM-Chemist | ICM-Chemist-Pro | ICM-VLS

This feature allows you to annotate a chemical spreadsheet according to functional group. It also allows you to flag substructures which may have poor ADME properties.

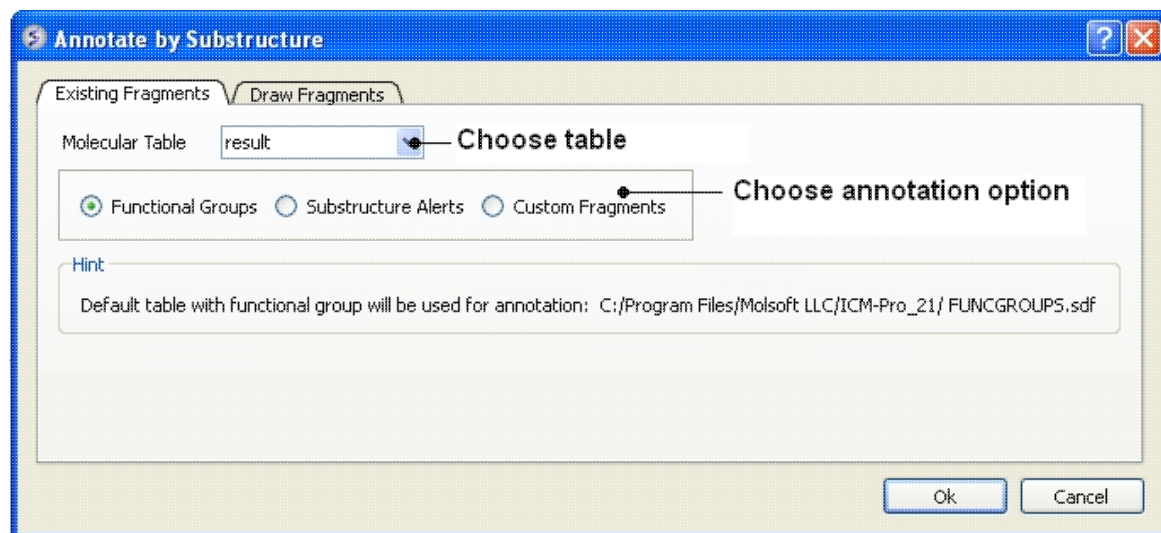

First read in a chemical spreadsheet or sdf file you wish to annotate.

To do this:

- Information on how to read into ICM chemical spreadsheets and structure can be found [here](#).

To annotate functional groups:

- **Chemistry/Annotate** by Substructure.
- Enter the name of the Molecular Table (Chemical Spreadsheet) or use the drop down button to locate it.
- Check the **Functional Groups** option.
- The functional groups will be listed in a new column in your chemical spreadsheet called **funcgroup**. The default table with functional group will be used for annotation called FUNCGROUPS.sdf in ICMHOME.

To annotate potentially poor ADME groups (Substructure Alert).

- **Chemistry/Annotate** by Substructure.
- Enter the name of the Molecular Table (Chemical Spreadsheet) or use the drop down button to locate it.
- Check the **Substructure Alerts** option.
- The alerts will be listed in a new column of your chemical spreadsheet called **alerts**. The default table with substructure alerts will be used for annotation called CHEMFILTER.sdf

To annotate by custom fragments

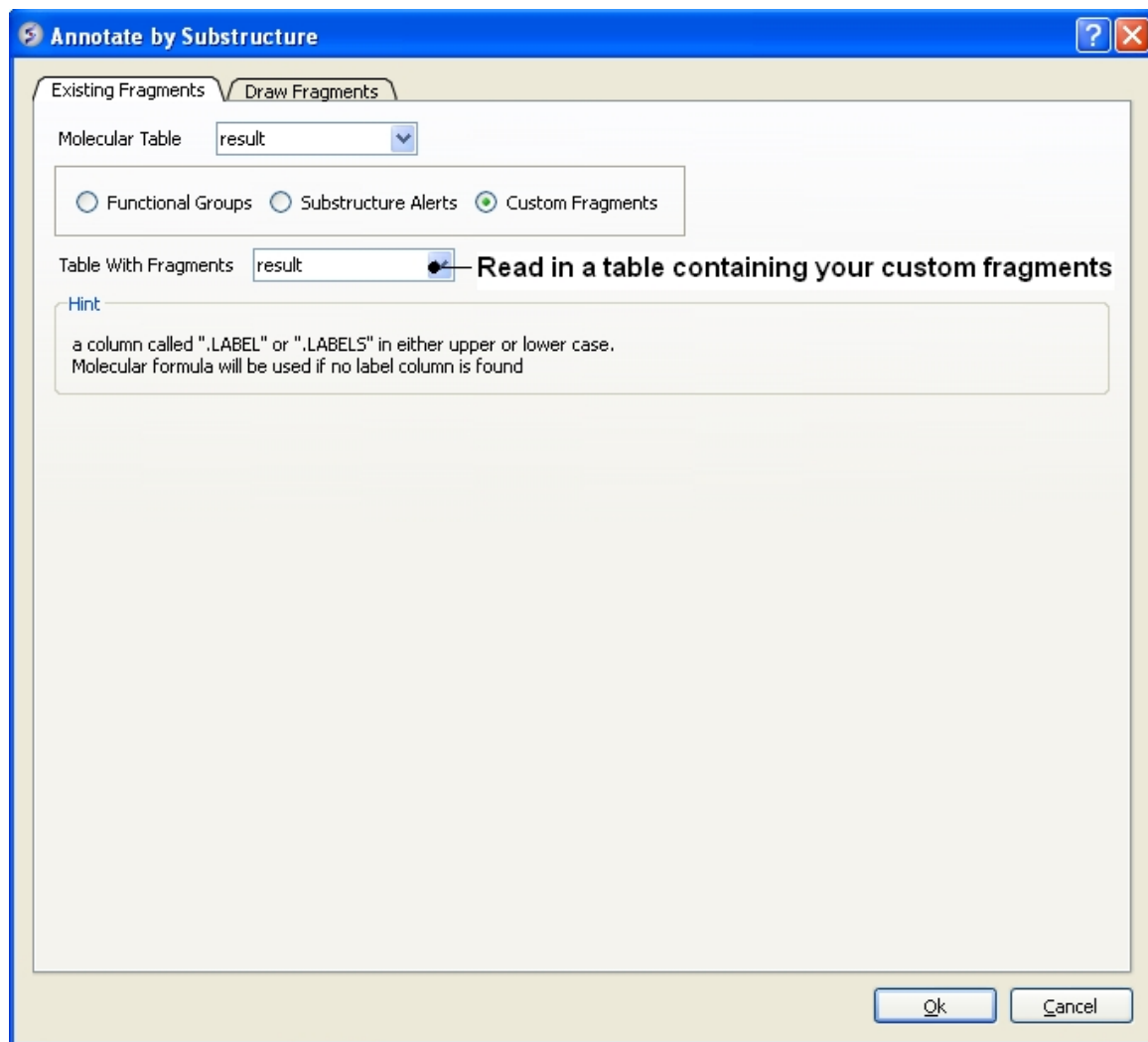

- Read into ICM a table with annotated fragments. The fragments should be labeled in a column called ".LABELS" or ".LABEL" in either upper or lower case. If not "LABELS" column is found the molecular formula will be used instead.
- **Chemistry/Annotate** by Substructure.
- Check the **Custom Fragments** button

To draw a fragment and annotate.

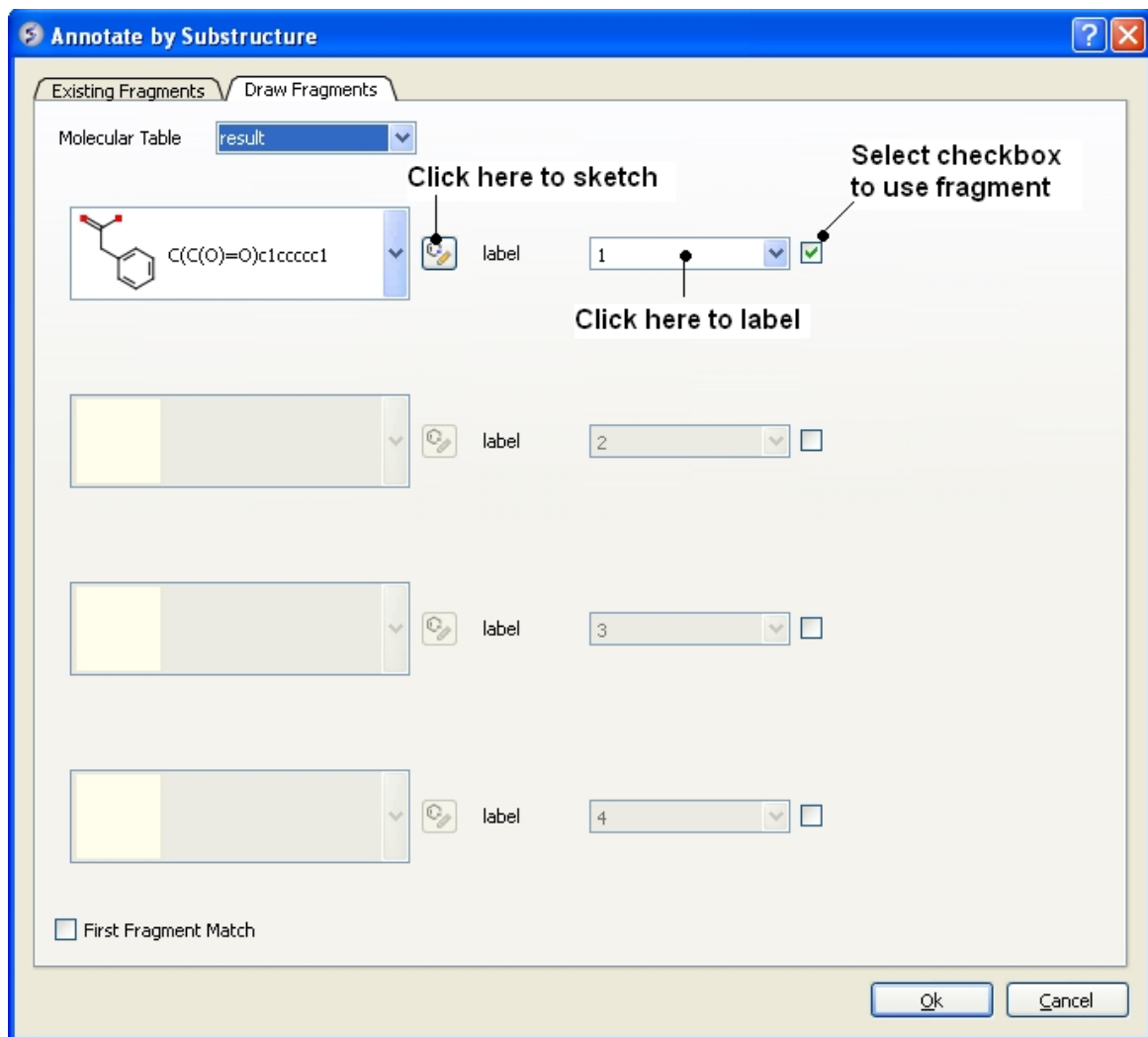

- Click on the **Draw Fragments** tab.
- Enter the SMILES string of the fragment or click on the ligand editor button in the dialog window to sketch the fragment.
- Enter a label name.
- Click the check box next to the label name.
- Click OK

7.13 Align/Color by 2D Scaffold

Available in the following product(s): ICM-Chemist | ICM-Chemist-Pro | ICM-VLS

This option **aligns** a set of sketches in a chemical table in the same orientation according to a defined scaffold or **color** by a common substructure.

- Read in a chemical table.
- Chemistry/Align-Color by 2D Scaffold
- Choose a loaded molecular table from the drop-down arrow.
- You can allow ICM to auto detect the common scaffold or draw a new scaffold using the molecular editor or choose the scaffold from a table (Index = row number).

7.14 Set Formal Charges

Available in the following product(s): ICM-Chemist | ICM-Chemist-Pro
| ICM-VLS

To set formal charge:

- Read in a chemical spreadsheet `File/Open SDF`
- **Chemistry/Set Formal Charges**
- Enter the name of the chemical spreadsheet (table).
- Choose the option to either make **Charge**, **Make Neutral**, or **Charge** according to ICM pKa Model
- Select the groups you want to charge or neutralize.
- The charges will automatically be added to your table.

7.15 Enumerate Formal Charge States

To enumerate formal charge states.

- Read in a chemical spreadsheet `File/Open SDF`
- Choose **Chemistry/Enumerate Formal Charge States**
- Enter the name of the chemical spreadsheet (Molecular Table)
- Choose the pH at which you wish to evaluate the charge
- Choose a window value.
- Click OK and a new table "_charge" will be displayed with the enumerated charge states.

About the Method

For basic charges the logic is following:

- atoms with $pK_a > pH + window$ is always charged
- atoms with pK_a inside the range $[pH - window : pH + window]$ will be enumerated as charged and uncharged.

For example if you have two centers with pK_a within the range then four states will be generated ($[0,0]$ $[+1,0]$ $[0,+1]$ $[+1,+1]$)

For acids it is similar.

7.16 Convert

Available in the following product(s): ICM-Chemist | ICM-Chemist-Pro
| ICM-VLS

7.16.1 3D to 2D Depiction

If you have a chemical table displayed containing 3D coordinates or you wish to reassign the 2D coordinates in an sdf file you can use this option.

- Read a chemical table (sdf file) into ICM.
- **Chemistry/Convert/2D Depiction**
- Enter name of loaded chemical table.
- Choose **In Place** if you want to overwrite the table.
- Choose the **Files** tab to run in batch mode.

Table contains 3D coordinates

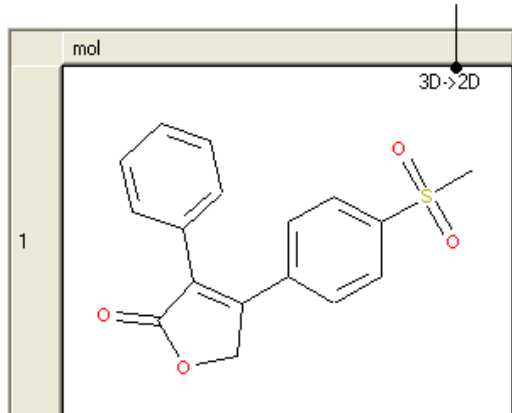

7.16.2 Convert Smiles or InChi to 2D

To convert smiles or InChi strings to 2D sketches

- Read in a table containing the smiles or InChi strings in separate rows. For example the smiles strings maybe in an Excel file and you can load this into ICM by saving the Excel file as comma-separated (csv).
- Select **Chemistry/Convert/Smiles or InChi to 2D**.
- Select the table you want to convert using the drop down arrow and the name of the column containing the smiles string.
- Select whether you wish to keep the smiles column in the new table.
- Click OK and a table will be displayed containing the 2D structure.

ct *) (1 table)

iology Chemistry Docking MolMechanics Windows Help

Calculate Properties
Standardize...
Annotate by Substructure...
Align/Color By 2D Scaffold...
Set Formal Charges...
Convert
Build Prediction Model
Predict
Generate 3D Conformers...
Generate Tautomers...
Generate Stereoisomers...
Generate Drug from Prodrug...
Generate Prodrug from Drug...
Enumerate Formal Charge States...
Ligand Energetics
Cluster Set
PCA Analysis
Compare Two Sets...
Merge Two Sets...
Select Duplicates...
Combinatorial Chemistry
Superposition
APF Tools
MolScreen Model
Load Example Table

2D To 3D...
3D To 2D Depiction...
Similar to 2D...
Structure to Smiles...
To Racemic...

		mol
		<chem>C(C(C(=O)N)N)O</chem>
226	<chem>CC(C)(C(c1ccncc1)=O)c1ccncc1</chem>	
227	<chem>CC(C)(C)NCC(c1ccc(c(CO)c1)O)O</chem>	
228	<chem>CC(C)/N=C(N)N=C(N)Nc1ccc(cc1)[C]</chem>	

7.16.3 Convert Structure to Smiles

To convert an sdf file of 2D or 3D chemical coordinate in Smiles:

- Read a chemical table (sdf file) into ICM.
- Select **Chemistry/Convert Structure to Smiles**.
- Select the table you want to convert using the drop down arrow and the name of the column containing the 2D sketch.
- Select whether you wish to keep the 2D sketch column in the new table.
- Click OK and a table will be displayed containing the smiles string.

7.16.4 Convert to Racemic

To remove stereo bonds and make all chemical centers R/S in a chemical table:

- **Chemistry/Convert to Racemic**
- Select the Molecular Table
- Select **In Place** if you wish to overwrite the table.



NOTE: To reassign stereo bonds use the Generate Stereoisomers option

7.17 Predict

Available in the following product(s): ICM-Chemist-Pro | ICM-VLS

To make a prediction using a model you need either ICM-Pro + Chemistry or ICMChemistPro.

Read the table of data into ICM from which you wish to predict. Make sure the table contains the same columns used for the learn model.

- Tools/Table/Predict
- Select which table you wish to make the prediction on.
- Select which model you wish to use.
- Check that the required columns are in the table. If they are absent a red mark will appear against the column that is missing.
- Click Predict.

7.18 Generate Tautomers

Available in the following product(s): ICM-Chemist-Pro | ICM-VLS

Theory

Tautomers are formed by an interconvertible reaction called tautomerization whereby there is a formal migration of a hydrogen atom along with a switch of a single bond and an adjacent double bond. A common example is the keto to enol tautomerism:

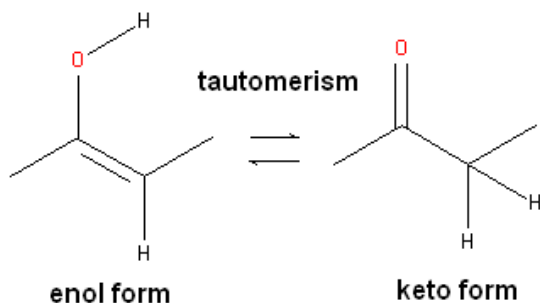

During tautomerization a chemical equilibrium of the tautomers will be reached based on several factors, including, pH, temperature and solvent. Tautomerizations are catalyzed by: bases (deprotonation,

formation of a delocalized anion, and, protonation at a different position of the anion; and acids (protonation, formation of a delocalized cation, and deprotonation at a different position adjacent to the cation).

ICM will only generate energetically favorable tautomers. Generally tautomers that have a change in hybridization state are less stable and so ICM will not generate these thus reducing the number of scaffolds generated. For example the keto form shown below is more stable by ~14 kcal.mol than the enol therefore ICM will not generate the enol form.

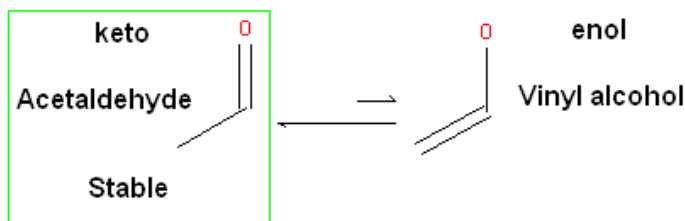

The tautomer generation MoldHf (heat of formation) was trained on the data from <http://webbook.nist.gov> (e.g. <http://webbook.nist.gov/cgi/cbook.cgi?ID=000050-00-0&Units=SI&cTG=on>). We used PLS regression and our custom fingerprints to train the model.

To generate tautomeric conformations of your compound:

- Select the compound(s) in the molecular table. Selected compounds are highlighted in blue.
- Right click in the table and select the option Chemistry/Enumerate Tautomers. Or select the Chemistry menu/Generate Tautomers.
- If you select Chemistry/Generate Tautomers a dialog box will be displayed. There is also an option to run in batch mode (click the **Files** Tab).
- Choose the table containing the compounds using the drop-down list.
- **Filter Unwanted Groups** option will filter results from patterns in the TAUTOFILTER.tab file provided in the distribution. If results match any row from that table then the it will be excluded.
- **Preserve Hybridisation** Although generally a change in hybridisation state will generate less stable compounds in some cases this is not the case and so you can choose to change hybridisation for a single atom.
- **Group Rows With Color** option will color tautomers from the same compound with the same color to visually highlight groups.
- The compounds will be displayed in a separate molecular table called TAUTOMERS.

How to generate tautomers.

The screenshot shows the Chem3D interface with a table of molecules. A menu is open on the left, highlighting 'Generate Tautomers'. A dialog box titled 'Generate Tautomers' is open, showing a dropdown menu for 'Molecule Table' set to 'my_database'. A callout box points to the 'Generate Tautomers' menu item with the text '1. Chemistry/Generate Tautomers'. Another callout box points to the 'Molecule Table' dropdown with the text 'Choose "Files" for batch mode'. A third callout box points to the 'my_database' dropdown with the text '2. Enter name of chemical table'. The table in the background has columns: name, model, vendor, molweight mol, mol_wt mol, and cid. It lists several molecules with their respective IDs and weights.

name	model	vendor	molweight mol	mol_wt mol	cid
C2H8O2N2	129	chembridge F14062 Biochemics F2014009	301.2	2.907	1
C2H8O2N2	501320	Biochemics F20140201	301.2	4.117	2
C2H8O2N2	501320	Biochemics F20140105	436.2	2.82	3
C2H8O2N2	501320	Biochemics F20140105	301.2	2.938	4
C2H8O2N2	501320	Biochemics F20140105	436.2	3.284	5
C2H8O2N2	501320	Biochemics F20140105	436.2	3.284	6

7.19 Generate Stereoisomers

Available in the following product(s): ICM-Chemist-Pro | ICM-VLS

Theory

Isomers are molecules which have the same chemical formula and sometimes the same kind of bonds but in which the atoms are arranged differently.

Structural isomers have different atom-to-atom connections e.g. propanol (C₃H₈O or C₃H₇OH) has two isomers Propan-1-ol and Propan-2-ol.

Diastereomers are not mirror images and have different internal dimensions (e.g. dihedral angles and distances between non-bonded atoms). They can be configurational diastereomers (which can be interconverted only by breaking bonds or by changing the configurations of stereocenters) or conformational diastereomers (which can be interconverted by rotation about bonds - including chair flips or by lone pair inversion).

Enantiomers have identical internal dimensions, and are nonsuperimposable mirror images. Enantiomers can be configurational and conformational.

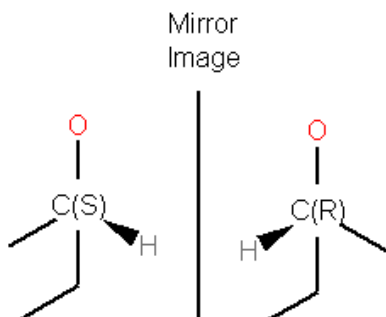

Enantiomers are distinguished based on the Latin terms for left (sinister) and right (rectus). In some cases where the handedness is unknown a chiral center can be labeled "RS" or unknown.

To enumerate and display in a separate table the stereoisomers of selected compounds.

- Select the compound(s) in the molecular table. Selected compounds are highlighted in blue.
- Right click in the table and select the option **Chemistry/ Enumerate stereoisomers**. Or select the Chemistry menu and choose **Generate Stereoisomers**. If you generate stereoisomers via the Chemistry menu you will get a dialog box whereby you can run the process in batch mode. There is also an option to color stereoisomers from the same compound with the same color.
- **Group Rows With Color** option will color stereoisomers from the same compound with the same color to visually highlight them.
- **Skip if Number of Centers Greater than** option can be used to filter out compounds which have a defined number of stereo centers. If you do not wish to filter just use the default **No limit** option.
- The compounds will be displayed in a separate molecular table called STEREOISOMERS.

NOTE: Stereoisomer generation will keep pre-defined stereo centers and only enumerate racemic ones.

From the Chemistry Menu:

How to generate stereoisomers.

1. Chemistry/Generate Stereoisomers

Choose "Files" for batch mode

2. Enter name of chemical table

mol	name	SMILES	mol	vendor	molWeight	molLogP	mol	id
1		<chem>C1=CC=CC=C1</chem>		129 chembio 314002 BiochemLab F204-0008	94.07	2.85	1	1
2		<chem>C1=CC=C(C=C1)C2=CC=CC=C2</chem>		501320 BiochemLab F204-0201	154.15	4.37	2	2
3		<chem>C1=CC=C(C=C1)C2=CC=CC=C2C3=CC=CC=C3</chem>			228.27	5.94	3	3
4		<chem>C1=CC=C(C=C1)C2=CC=CC=C2C3=CC=CC=C3C4=CC=CC=C4</chem>			302.37	7.51	4	4
5		<chem>C1=CC=C(C=C1)C2=CC=CC=C2C3=CC=CC=C3C4=CC=CC=C4C5=CC=CC=C5</chem>			376.47	9.08	5	5
6		<chem>C1=CC=C(C=C1)C2=CC=CC=C2C3=CC=CC=C3C4=CC=CC=C4C5=CC=CC=C5C6=CC=CC=C6</chem>		501324 BiochemLab F204-0103	450.53	10.64	6	6

```

low/de> delete hydrogen my_database.mol
low/de> modify my_database.mol auto
low/de> delete my_database.cluster(1)
low/de>
  
```

From a chemical spreadsheet:

ricinLigands2D STEREOISOMERS

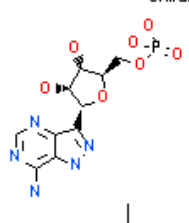
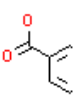
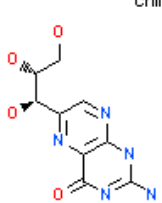
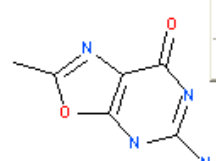
mol	NAME_
 chiral	ricinLigands2D Edit Cells by Double-click Table View Find in Table Ctrl+F Color By Clustering... Analysis
 Select one or multiple compounds and right click on the drawing.	Copy Molecule Image Copy Molecule Image To Album Save Molecule As EPS... Save Molecule As Image...
 chiral	Edit Molecule... Query Molecule Chemistry Cell mol[1]
	Copy Molecule Ctrl+C Paste Ctrl+V Print Table... Ctrl+P Enumerate Stereoisomers (current row) Enumerate Tautomers (current row) Remove Salt (current row) Convert to 3D and Optimize Load and Preserve Coordinates Conformation Generator (selected rows) Chemical Template Superposition (selected rows)

Results will be in the table entitled "STEREOISOMERS"

NOTE: Only centers with unknown chirality will be enumerated.

7.20 Prodrug

To generate a drug from a prodrug:

- Read in a chemical table (sdf file) into ICM.
- Choose the menu Chemistry/Generate Drug from Prodrug and a dialog box will be displayed.
- Enter the name of the Chemical Table.
- Select the reactions you wish to use to generate the drug. You can choose "Prodrug", "All", "Hydrolysis" "Reduction". You can choose the option "all" to use all the available reactions. You can see the reactions in each subset by clicking on the tab labeled "Load Reaction Panel". A chemical table containing the reactions will be displayed and the reaction is labeled in a column called "subset".
- You can choose to output the results in the "in-addition" mode where the converted drug will be in the row below the prodrug or "replace original" whereby the prodrug will be replaced with the converted drug.

To generate a prodrug from a drug:

- Read in a chemical table (sdf file) into ICM.

- Choose the menu Chemistry/Generate Prodrug from drug and a dialog box will be displayed.
- Enter the name of the Chemical Table.
- Select the reactions you wish to use to generate the prodrug. You can choose "carboxylate", "hydroxyl", "amino", "diol", "sulfide". You can choose the option "all" to use all the available reactions. You can see the reactions in each subset by clicking on the tab labeled "Load Prodrug Panel". A chemical table containing the reactions will be displayed and the reaction is labeled in a column called "subset".
- You can choose to output the results in the "in-addition" mode where the converted prodrug will be in the row below the drug or "replace original" whereby the drug will be replaced with the converted prodrug.

7.21 Ligand Energetics

Available in the following product(s): ICM-Chemist-Pro | ICM-VLS

7.21.1 Conformational Entropy

Entropy of the conformational ensemble is calculated according to the regular thermodynamic formula i.e. $kT \log(\text{Sum}(\text{Exp}(-E_i/kT)))$, E_i is the energy of the i -th conformation over the ground state, summation is over all conformations.

To calculate the conformational entropy of chemicals in an SDF file or a chemical spreadsheet:

- **Chemistry/Ligand Energetics/Conformational Entropy**
- Choose either the **Local Tables** (loaded chemical spreadsheet) or {Files} (SDF file) tab.
- Enter the maximum number of conformations you wish to generate.
- Enter a **vicinity** value. For more information on vicinity please see the command language manual
<http://www.molsoft.com/man/reals.html#vicinity>
- Enter a **effort** value. This relates to the length of sampling time.
- Check boxes for Sampling Rings or Systematic Search (instead of Monte Carlo).
- Click OK.

The calculation will then run and you will see a progress bar in the bottom right hand corner of the GUI or you can check the progress of the job go to **Windows/Background**. When the job has finished:

- A table will be displayed called **entropies** with a column called **Conf Entropy**. The energy is in kcal/mol.

7.21.2 Strain

To calculate the conformational strain of chemicals in an SDF file or a chemical spreadsheet:

- **Chemistry/Ligand Energetics/Strain**
- Choose either the **Local Tables** (loaded chemical spreadsheet) or {Files} (SDF file) tab.
- Enter a **effort** value. This relates to the length of sampling time.
- Check the **Systematic Search** option if you do not want to use Monte Carlo search.

The calculation will then run and you will see a progress bar in the bottom right hand corner of the GUI or you can check the progress of the

job go to **Windows/Background**. When the job has finished:

- A table will be displayed called **strain** with a column called **Strain**. The energy is in kcal/mol.

7.22 Cluster Set

Available in the following product(s): ICM-Chemist | ICM-Chemist-Pro | ICM-VLS

Clustering is described in more detail in the **Tables Clustering** section of this manual. To undertake chemical clustering choose:

- Chemistry/Cluster Set

7.22.1 How to perform chemical clustering.

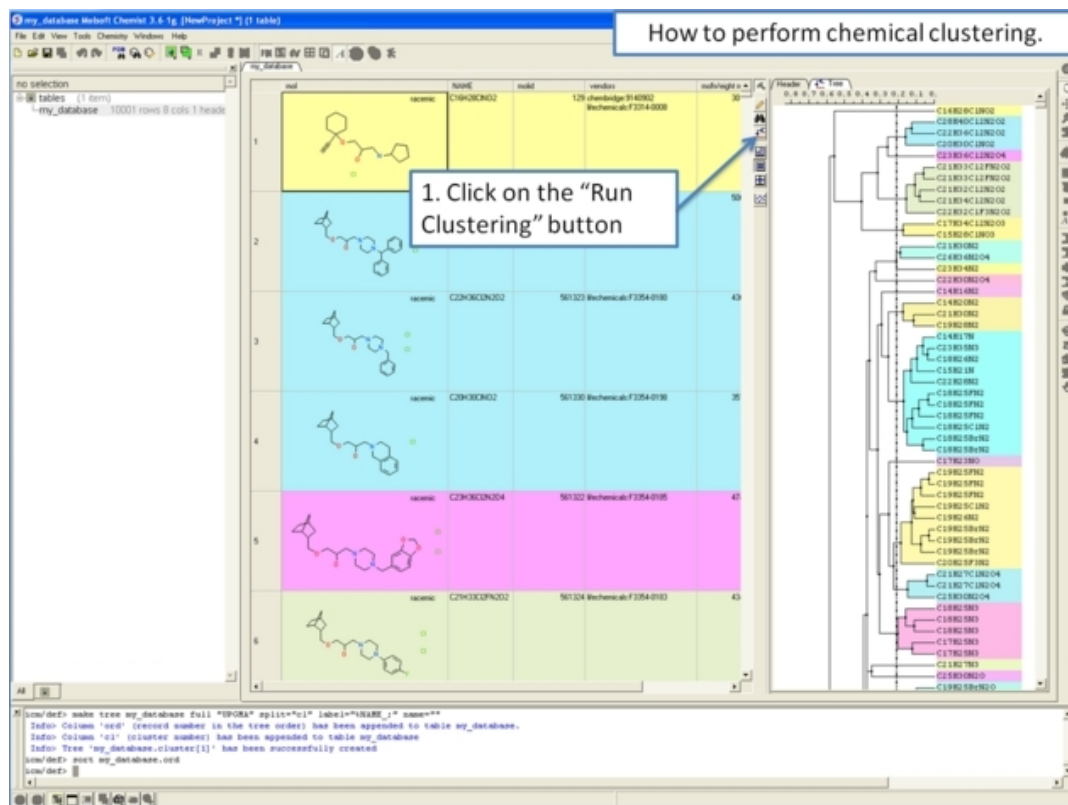

How to perform chemical clustering.

1. Click on the "Run Clustering" button

```
sum/det> make tree my_database full "DPOB" split="cl" label="NAME_" name=""
Info: Column 'mol' (second number in the tree order) has been appended to table my_database.
Info: Column 'cl' (cluster number) has been appended to table my_database.
Info: Tree 'my_database.cluster[1]' has been successfully created.
sum/det> exit my_database.oss
sum/det>
```

7.22.2 How to select representative centers from a tree.

How to select representative centers from a tree.

Right click in white space for all centers or on a node for centers of a branch

id	name	mol	vendor
1	C2H4OC2N02	129	chembridge 914002
2	C2H4OC2N02	56120	Bechemab F2354021
3	C2H4OC2N02	56120	Bechemab F2354019
4	C2H4OC2N02	56120	Bechemab F2354018
5	C2H4OC2N04	56120	Bechemab F2354015
6	C2H4OC2N02	56120	Bechemab F2354013

```

low/de> make tree my_database full "DFORE" split="1" label="NAME_1" name=""
Info: Column 'oid' (record number in the tree order) has been appended to table my_database.
Info: Column 'cl' (cluster number) has been appended to table my_database.
Info: Tree 'my_database-cluster[1]' has been successfully created.
low/de> sort my_database-oid
low/de>
  
```

7.22.3 How to reorder branches and change the distance of trees.

How to re-order branches and change distance of tree.

To change distance - click and drag here

To re-order branches - right click in white space

id	name	mol	vendor
1	C2H4OC2N02	129	chembridge 914002
2	C2H4OC2N02	56120	Bechemab F2354019
3	C2H4OC2N02	56120	Bechemab F2354018
4	C2H4OC2N02	56120	Bechemab F2354013
5	C2H4OC2N04	56120	Bechemab F2354015
6	C2H4OC2N02	56120	Bechemab F2354013

```

low/de> make tree my_database full "DFORE" split="1" label="NAME_1" name=""
Info: Column 'oid' (record number in the tree order) has been appended to table my_database.
Info: Column 'cl' (cluster number) has been appended to table my_database.
Info: Tree 'my_database-cluster[1]' has been successfully created.
low/de> sort my_database-oid
low/de>
  
```

7.22.4 How to edit the tree - labels, spacing and coloring.

How to edit the tree – labels, spacing and coloring.

To edit labels, spacing and coloring: right click on the tree

To change record labels: right click in white space and select "Change Record Labels"

7.22.5 Auto Close Tree Mode

To make working with large cluster trees a little easier you can activate the auto close mode which will close downstream clusters and make them more compact.

To do this:

- Right click in white space on the cluster and choose Preferences.
- Select "Auto Close Clusters Downstream".

7.22.6 Calculate Maximum Common Substructure for Nodes

To calculate the Maximum Common Substructure (MCS) for nodes in a tree:

- Chemistry/Cluster Set
- Select the option Calculate Maximum Common Substructure for Nodes
- Hover over a node to view the MCS.
- Right click on a node and choose "Extract Maximum Common Substructure" to extract it to a table.

The image shows two parts of a software interface. On the left is the 'Clustering Parameters' dialog box. On the right is a dendrogram showing hierarchical clustering of molecules, with a callout showing the Maximum Common Substructure (MCS) for a selected node.

1. Chemistry/Cluster Set (Red box)

2. Select here (Yellow box pointing to 'Calculate Maximum Common Substructure for Nodes')

3. Hover over node to view MCS (Green box pointing to a node in the dendrogram)

4. Right click on a node to extract MCS to a table (Purple box pointing to a node in the dendrogram)

The 'Clustering Parameters' dialog includes the following options:

- Table: screen_chembr_d1
- Name: (empty)
- Take Labels from Columns: ID
- Balloon popup (E.g. mol, ID): mol
- Keep the existing trees:
- Add column with cluster numbers, name: cl (checked)
- Calculate Maximum Common Substructure for Nodes: (Build for the selected 0 rows (at least 2 required))
- Descriptors:
 - all numerical columns
 - the seq column only
 - use existing distance matrix: (empty)
 - the "mol" column only (Fingerprints)
 - the mol column only (2D pharmacophore)
- Method: Tree (selected)
 - Parameters: Memory required: 0 MB
 - Linkage type: UPGMA
 - Keep distance matrix:
 - Compressed hierarchical clustering:

The dendrogram on the right shows a hierarchy of clusters. A callout window displays the MCS for a selected node, showing a chemical structure with highlighted atoms (R1, R2, R3, R4, R5) and a list of molecule IDs: 5538545, 5572455, 6072214, 5564016, 7471392, 5852077, 6945645, 6968738, 6659827, 6882573, 6671224, 6649930, 7002925, 7003510, 6673515, 6666047, 6140416, 6860968.

7.22.7 R Group Decomposition from Clustering Node

To perform R-group decomposition directly from a cluster node:

- Chemistry/Cluster Set
- Select the option Calculate Maximum Common Substructure for Nodes.
- Hover over a node to view the MCS.
- Right click on a node and choose "R-group decomposition for node".

The resulting table can be used for R-Group Enumeration or SAR.

1. Chemistry/Cluster Set and choose the calculate Maximum Common Structure option.

2. Right click on node

3. New chemical table

	molName	molMol ID	molWt
1	CC(=O)O	1	60.05
2	CC(=O)O	2	60.05
3	CC(=O)O	3	60.05
4	CC(=O)O	4	60.05
5	CC(=O)O	5	60.05
6	CC(=O)O	6	60.05
7	CC(=O)O	7	60.05
8	CC(=O)O	8	60.05
9	CC(=O)O	9	60.05
10	CC(=O)O	10	60.05
11	CC(=O)O	11	60.05
12	CC(=O)O	12	60.05
13	CC(=O)O	13	60.05
14	CC(=O)O	14	60.05
15	CC(=O)O	15	60.05
16	CC(=O)O	16	60.05
17	CC(=O)O	17	60.05
18	CC(=O)O	18	60.05
19	CC(=O)O	19	60.05
20	CC(=O)O	20	60.05

7.23 PCA Analysis

Available in the following product(s): ICM-Chemist | ICM-Chemist-Pro | ICM-VLS

PCA analysis is described in the tables section here.

7.24 Visualize Chemical Space

There are two options to visualize chemical space:

- Maximum Common Substructure (MCS) Dendrogram
- Self Organized Network

7.24.1 Maximum Common Substructure (MCS) Dendrogram

The MCS method is K-greedy algorithm which simultaneously grows K different common substructures applying scoring and resorting on each step.

To display the interactive MCS dendrogram:

- Read in a chemical spreadsheet.
- Chemistry/Visualize Chemical Space/MCS Dendrogram
- Enter the name of the table you wish to analyze.
- Enter the name of the column you wish to use to label the points in the dendrogram.
- Choose **Optimize MCS** to minimize overlapping by branches in the tree.
- Click OK and the dendrogram will be displayed on the right hand side panel.

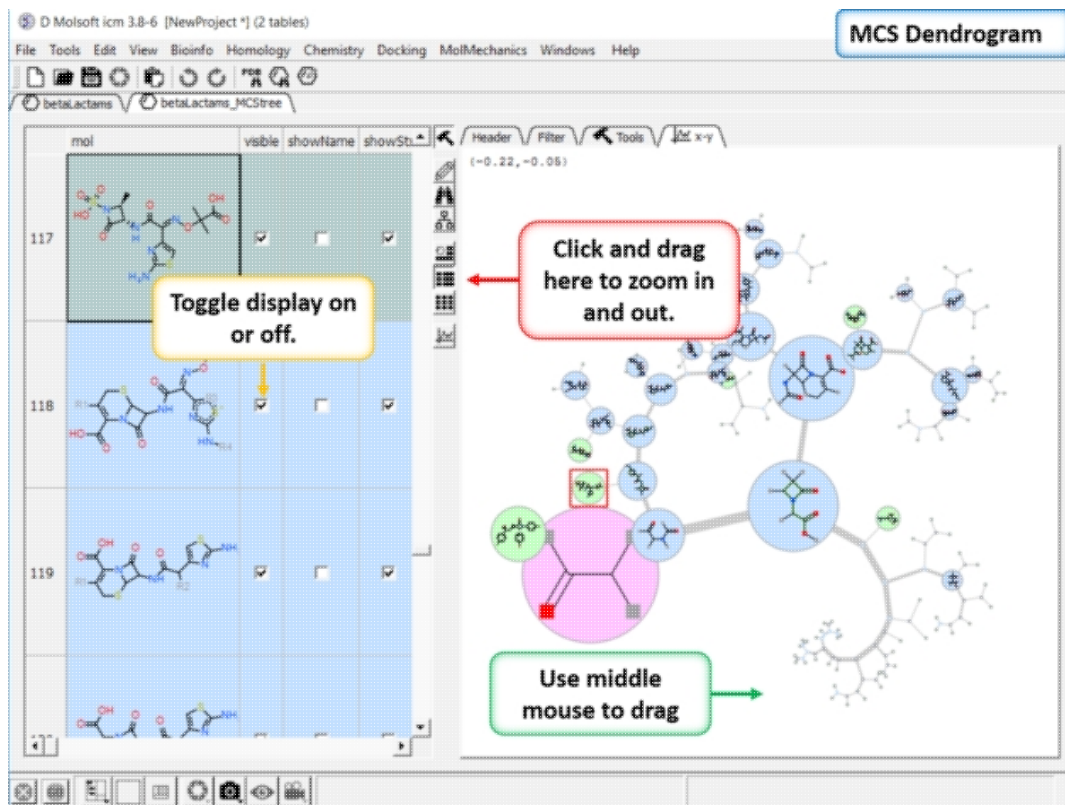

You can display and undisplay the points and labels by using the check boxes in the columns "visible", "showName" and "showStr". You can right click on the column and choose (un)check all. Points in the dendrogram are fully interactive and linked to the table. You can zoom and translate the plot around the space. The points are colored by > blue = common substructure, green = original compounds pink = root (most common)

7.24.2 Self Organized Map

A Self Organized Map (SOM) is a way to represent higher dimensional data in 2D (or 3D) such that similar data is grouped together. Nodes in 2D map are called neurons. Each neuron is assigned a weight vector of the same dimensionality as input space - you can read more here.

In ICM the initial placement can be either 1). random or 2). find four mutually remote points in the input dataset and put in the corners and uniformly distribute the rest. The training is undertaken in the following way: a vector is chosen at random from the training set, then ICM finds the node with the closest distance to the chosen vector. Next the radius of the Best Matching Unit (BMU) neighborhood is calculated and then the weights of the BMU neighborhood nodes are adjusted - this is repeated for N iterations. The final mapping stage assigns input vectors to their closest nodes.

To run the Self Organized Map method in ICM:

- Read a sdf file into ICM.
- Chemistry/Visualize Chemical Space/ Self Organized Map
- Enter the name of the chemical table.
- You can choose to color the nodes by a particular column value and adjust the coloring by the Aggregate method (e.g. all members of the cluster will be colored by average, min or max).
- You can choose to select one or more columns of data to use as Descriptors.

- The map dimensions can be changed from 'auto' by adding an integer e.g. 4 will make a map size of 4x4
- If you do not check randomize - the method will use the four mutually remote points in the input dataset and all other initial points will be generated so they spread uniformly between these four.
- Connectivity edges option is for visualization purposes only to show 'close' clusters.

A map containing the nodes be displayed as shown below. Each node contains a stacked cluster of input compounds. Sequential clicking on the node loops through the representatives.



7.25 Compare Two Sets

Available in the following product(s): ICM-Chemist | ICM-Chemist-Pro
| ICM-VLS

To compare two chemical tables for similar compounds:

- Read the two tables into ICM.
- **Chemistry/Compare Two Sets...**
- Select the first table from the drop-down list and then select the second table.
- Choose whether you want to use **exact** or **similarity** comparison. If the **similarity** option is selected a **Distance** value needs to be entered. The distance value should be decreased below 0.5 (0.2 or 0.3 or even smaller if you want to find "strong" similarity differences. The distance relates to the Tanimoto distance as described here
- Choose whether you want to **Select Matching Records** or **Show Only Different Records**.
- Select OK
- Similar compounds will be highlighted blue (selected). A selection can be transferred to a new table by right-clicking on the table and select **Copy Selection to ICM Table**.

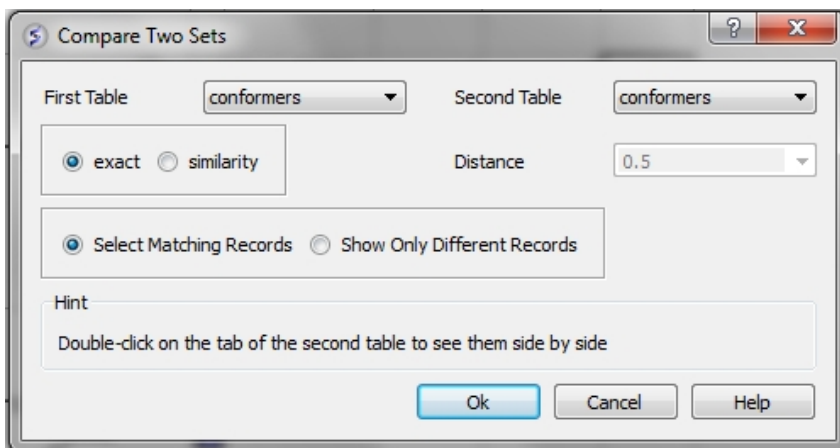

7.26 Merge Two Sets

Available in the following product(s): ICM-Chemist | ICM-Chemist-Pro | ICM-VLS

To merge two tables:

- Read the two tables into ICM.
- Chemistry/Merge Two Sets
- Select the first table from the drop down list (Table A) and the column you wish to use to merge the table by.
- Select merge method 1. **inner** - only molecules present in BOTH A and B tables are kept; or 2. **left** ALL rows of A are kept ; or 3. **right** ALL rows of B are kept.
- Select the second table from the drop down list (Table B) and the column you wish to use to merge the table by.
- Enter a name for the output table.
- Click OK and a new table will be displayed.

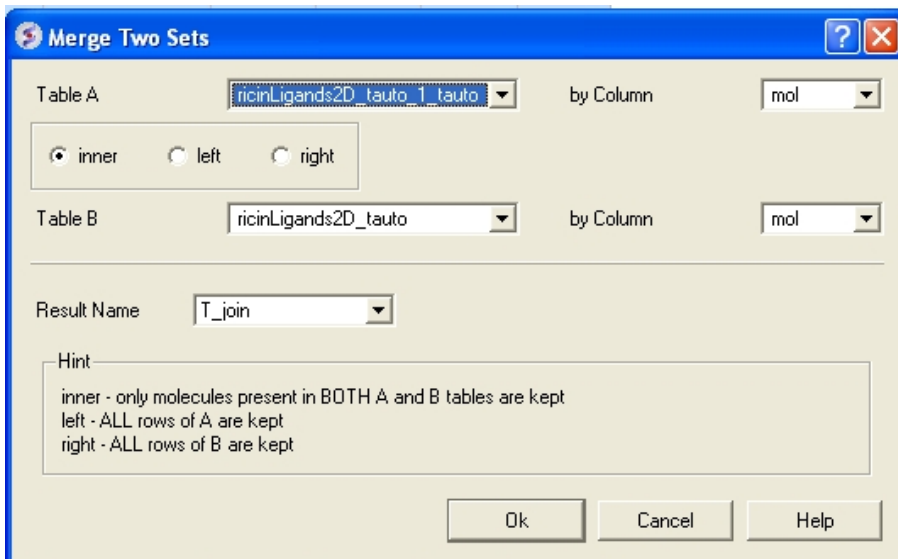

7.27 Select Duplicates

Available in the following product(s): ICM-Chemist | ICM-Chemist-Pro | ICM-VLS

NOTE: Gui option is available in versions 3.5-10 and higher. The command line options for this function are described in the ICM Command Language manual at <http://www.molsoft.com/man/icm-functions.html#Index-chemical>

This option allows you to select and remove duplicate chemicals in a table.

- Read a chemical table into ICM.
- Chemistry/Select Duplicates
- Enter the table name you want to check for duplicates
- Enter whether you want chirality or the salts included in the analysis.
- Press OK
- Duplicate compounds will be **highlighted** blue in the table. You can delete them by right clicking on the row header and selecting **Delete Row(s)**

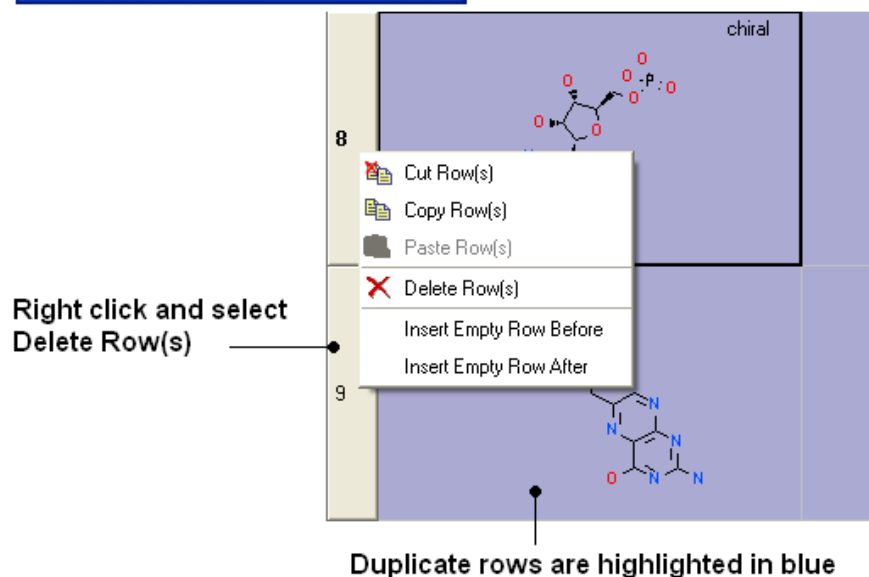

7.28 Multi Parameter Optimization

Multi Parameter Optimization (MPO) is a method that can be used to derive a score for the relative importance of a number of different chemical properties. For example Lipinski Rules (LopP, MW, Nof(HBD) , Nof(HBA) and CNS (LogP, PSA, MW, pKa, MW, Nof(HBD)).

To run MPO:

- Read in a Chemical table.
- Chemistry/MPO/Create New MPO Score
- Select the inbuilt Lipinski or CNS parameters or make your own by choosing Empty.
- Choose whether you want to assign property colors and click OK.
- You will then see a panel on the right hand side of the spreadsheet under the table Tools tab.

- If you chose "Empty" you will need to add parameters either from MolSoft's inbuilt functions or from an existing column.
- If needed Adjust the High, Low, Slope, Value and Weight columns by clicking in the cell and editing.

myMPO Molsoft icm 3.8-6 [NewProject *] (2 tables)

File Tools Edit View Bioinfo Homology Chemistry Docking MolMechanics Windows Help

search | Speed |

PDB Search | text | Fields | Append

myMPO

Parameter	Low	High	Slope	Value	Weight
1 mol_LogP	0	4	1		1
2 molWeight	ND	450	50		1
3 nof_HBD	ND	2	1.5		1
4 molPSA	30	100	10		1
5 pKa_mb	ND	9	1		1

Header Filter Tools

Edit

Data Table | xdict | Column | NAME

Add Parameter From Existing Column

Function | molWeight

Add Parameter From Function

Apply

Input Table | xdict

Calculate MPO Score

1. Chemistry MPO

2. If needed - add additional parameters

3. Adjust values if needed.

4. Calculate Score

- Click on Calculate MPO Score and a results table will be displayed containing a Score and the parameter bars.
- Sort the Score column (myMPO).

myMPO Molsoft icm 3.8-6 [NewProject *] (2 tables) MPO Results Table

File Tools Edit View Bioinfo Homology Chemistry Docking MolMechanics Windows Help

search ligedit

PDB Search Append

1. MPO Score – Click on column header to sort

mol	myMPO	myMPO BARS	Molecule Name	Class	Sy
55	4.669		Eszopiclone	D	
56	4.669		Zopiclone	D	
57	4.666		Desipramine	D	

2. Bars for each parameter

7.29 Combinatorial Chemistry

Available in the following product(s): ICM-Chemist | ICM-Chemist-Pro | ICM-VLS

7.29.1 Sketch Markush Structure

Tutorial | Video

To create or modify a Markush Structure:

- Use the Molecular Editor to sketch the scaffold as shown below. Right click on an atom and choose -> Element-> R1,R2....

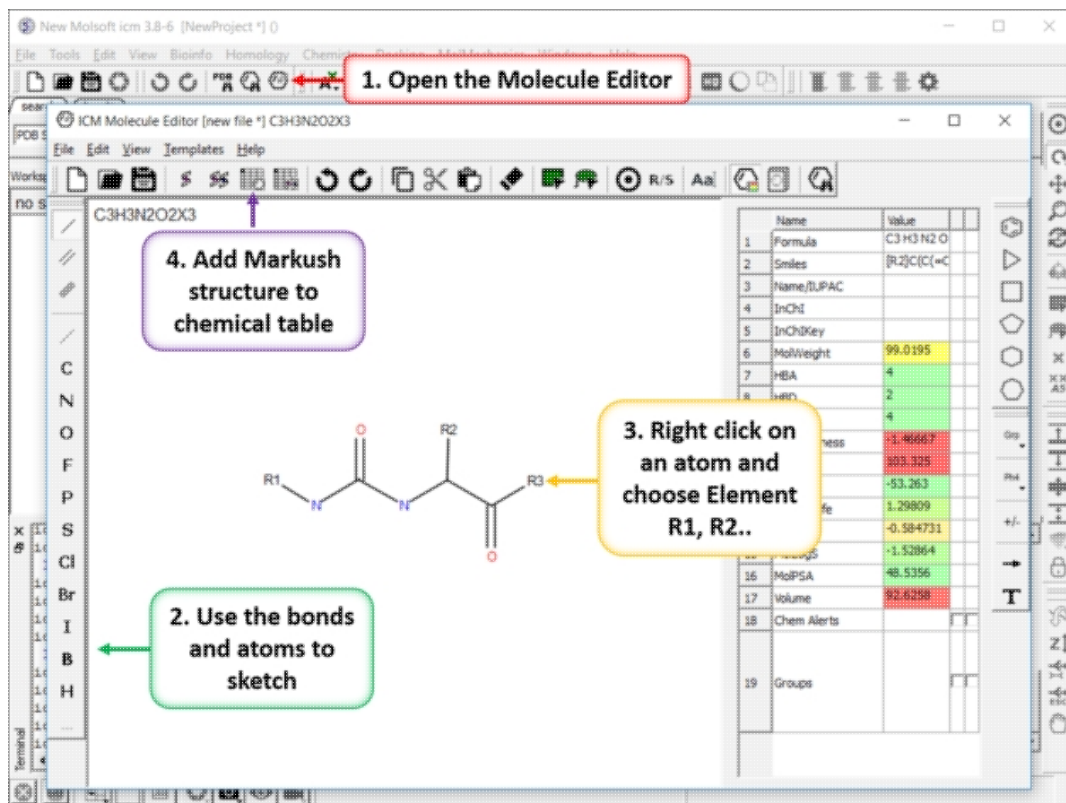

- Save the sketch to a chemical table by clicking on the "Append Molecule to Chemical Table" button in the Molecule Editor.
- Close the Molecular Editor window by clicking on the cross in the top right hand corner and the changes will be submitted to the table.

7.29.2 R-Groups

ICM has an inbuilt local database of R-groups generated from ChEMBL data. To open this file:

- Chemistry/Combinatorial Chemistry/ Load R Group Database
- A table of R-groups will be displayed - attachment points are represented by asterisk. The 'freq' column represents the number of pairs found in ChEMBL for that scaffold.

You can sketch your own substituents:

- Open the Molecular Editor.
- Sketch the substituent and use > right click > attachment point to assign the attachment point.

You can also split a chemical table into fragments as described [here](#).

You can read in an SDF, mol, smiles file containing fragments. If you do not want the first atom of the substituents to be the attachment point you need to define the attachment point. Attachment points are automatically assigned when you extract fragments or you can define them manually by using the molecular editor (as described above).

In many combinatorial chemistry options there is an option to use LigEdit Modifiers. These are the substituent groups you see in the edit panel in the 3D Ligand editor.

7.29.3 Create Markush

To create a Markush structure:

1. Read in your R-Groups

2. Click to Sketch Markush Structure

3. Click Next

- Read in the R-groups for your Markush structure.
- Chemistry/Combinatorial Chemistry/Create Markush
- Click on the editor button and sketch the Markush structure.

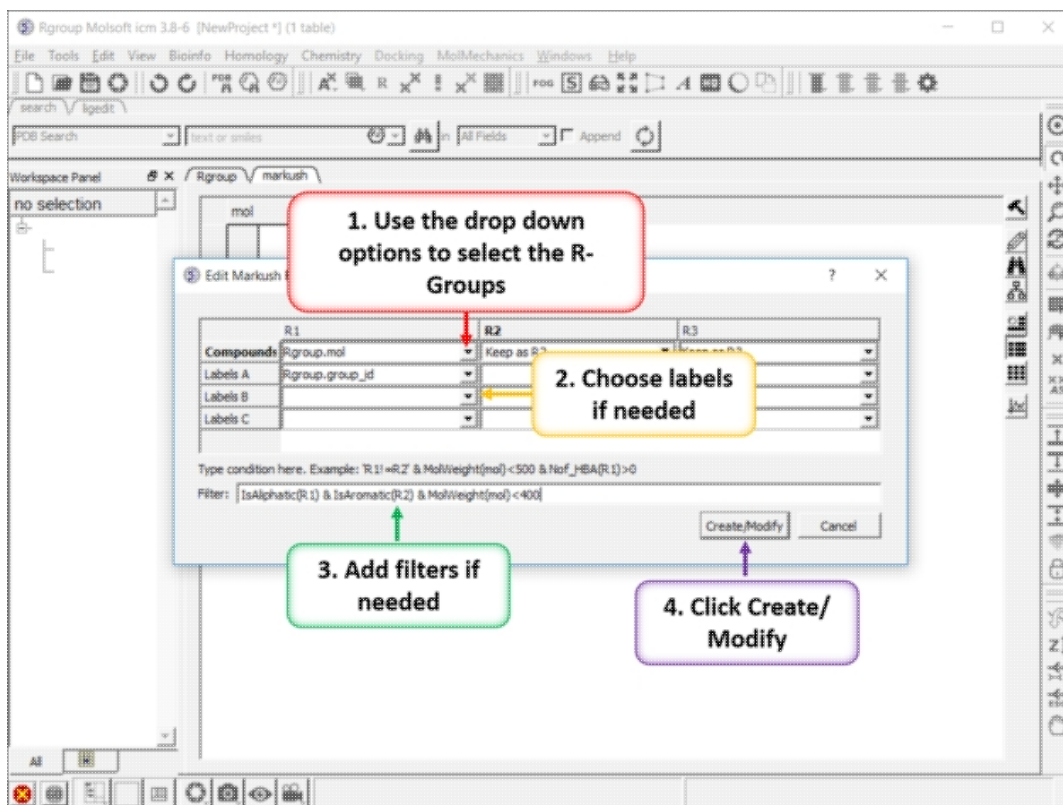

- Use the drop down arrow to select a R-group table for each of your R-groups.
- You can choose to associate labels from the R-group table if needed.
- You can add filters if needed (e.g. IsAliphatic(R1) & IsAromatic(R2) & MolWeight(mol)) Click Create/Modify.

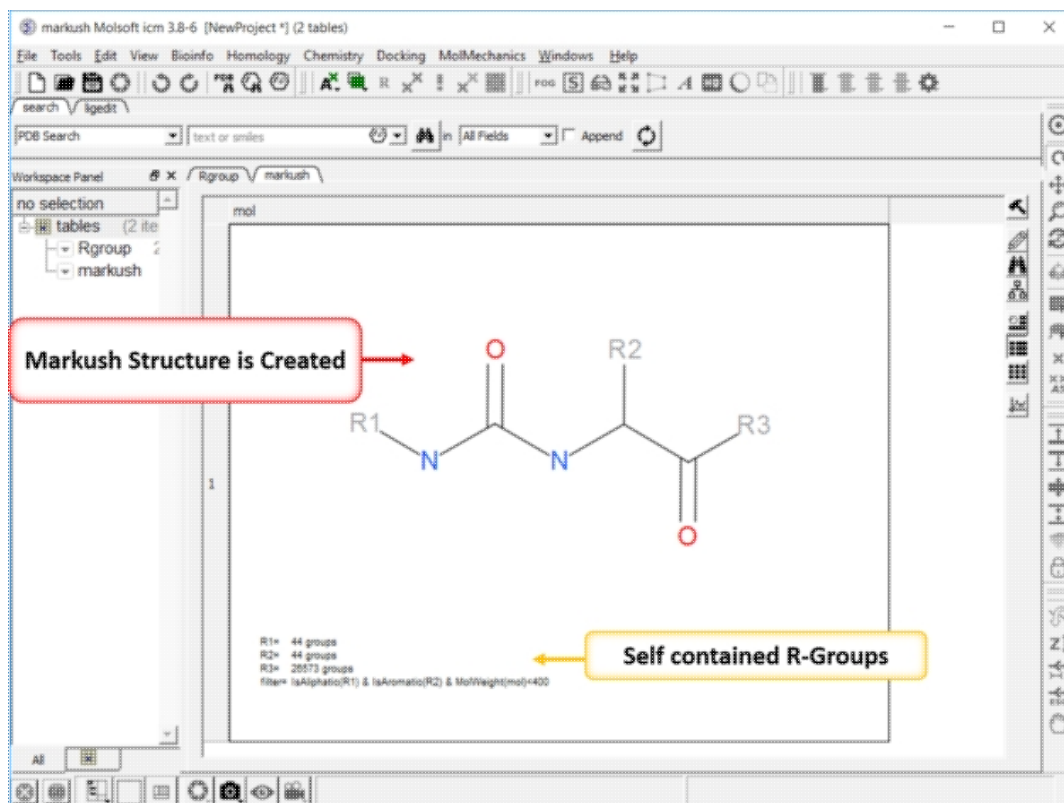

- The Markush structure will then be created with embedded R-groups and filters.
- You can extract the R-groups again to separate tables by: Right click on the Markush structure in the table and choosing the option "Extract Markush/Scaffold R-groups".

NOTE: Once a Markush is created you can right click on it in the chemical table you will see two convenient options 1. Edit/Markush Scaffold Properties and 2. Extract Markush Scaffold R-groups.

7.29.4 Enumerate by Scaffold

Tutorial | Video

To enumerate a library based on R-groups:

- Sketch the Markush structure and save it in a chemical spreadsheet.
- Read in the R-Group substituents you wish to use to enumerate the library.
- Right click on the structure and select Chemistry/Enumerate R-groups or use the Chemistry/Combinatorial Chemistry/ Enumerate by Scaffold-Markush menu. If you use the menu option you will need to choose the table containing the scaffold from the drop down list of currently loaded tables. The index number refers to the row number in the scaffold table. Click OK.
- Select the R1, R2... table, labels and filters if necessary. As an example of a filter you could use $R1 \neq R2$, OR $MolWeightA$ a new table will be produced called **T_enum** with the Template structure highlighted in red.

7.29.5 Enumerate by Reaction

Additional Resources:

[Tutorial](#) | [Video](#) | [Command Line Docs](#)

Reactions can be drawn using the ICM Molecular Editor. Reactants should be drawn side-by-side (no + sign is necessary) and separated from the product using the arrow. See example shown below:

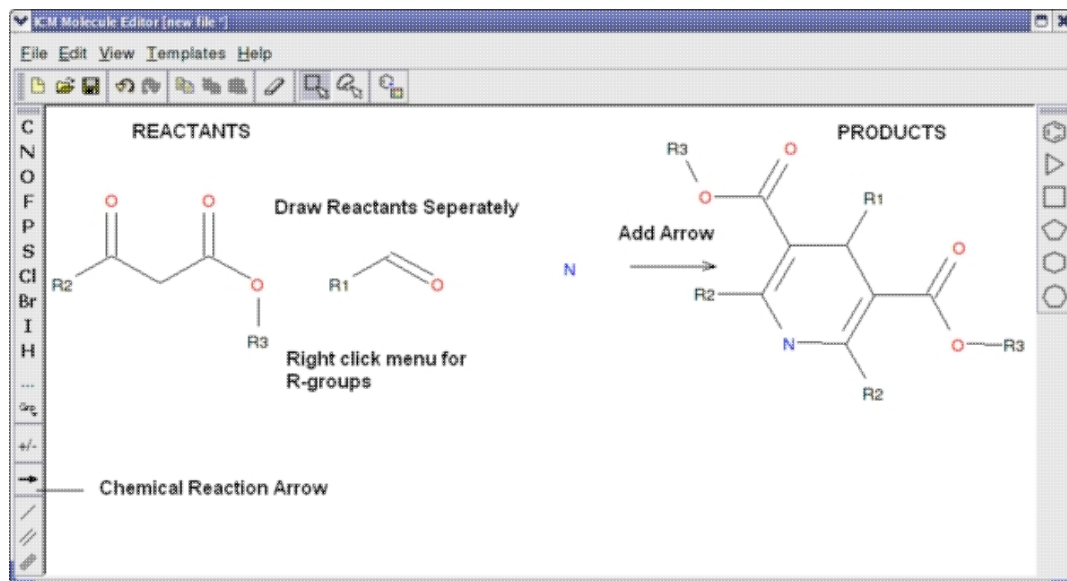

This example is available in the ICM distribution as `example_reaction1.icb`. The reaction is the Hantzsch Dihydropyridine (Pyridine) Synthesis. This reaction allows the preparation of dihydropyridine derivatives by condensation of an aldehyde with two equivalents of a beta-keto ester in the presence of ammonia. Subsequent oxidation (or dehydrogenation) gives pyridine-3,5-dicarboxylates, which may also be decarboxylated to yield the corresponding pyridines.

In this example we have two reactants therefore it is necessary to have two reactant substructure tables loaded into ICM. ICM will match the substructure drawn in the reaction with the chemicals in the reactant table.

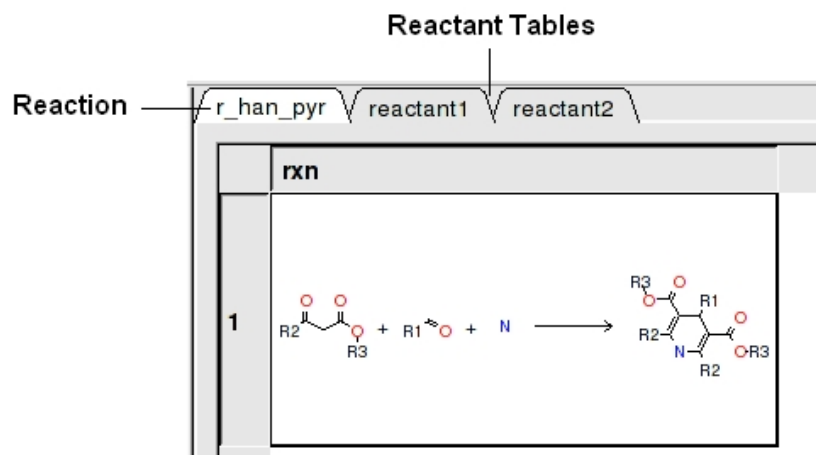

reactant 1 table:

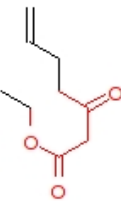
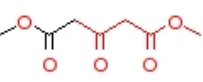
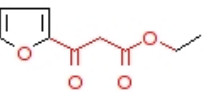
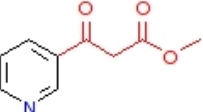
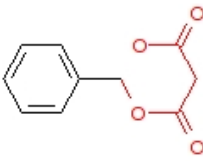
r_han_pyr	reactant1	reactant2	Substructure search: Found 88 hits of 'O=C([C;D2]C(=O)O[R3])[
	molid	MolW	mol	vendors
18	65236	170.094		asdi:500028335
19	87804	174.053		apolloscientific:12582 asdi:500014701
20	65360	182.058		apolloscientific:13718 keyorganics:11X-0925
21	87822	179.058		apolloscientific:2965 interchim:616
22	3341	194.058		asdi:500016383

To apply a reaction:

- Chemistry/Enumerate by Reaction.
- In this example (example_reaction1.icb) we already have the reaction drawn in a chemical table. Therefore select the **Choose Table With Reaction**. If you would like to draw a new reaction select **Draw New Reaction**.
- Enter the name of the table containing the reaction. If you have more than one reaction drawn you can select the row using the index option.
- Click OK and then you will be asked to enter the Reactants. Select the reactant tables from the drop down arrow for Reactant 1 and Reactant 2.

- You can transfer information to the reactant table by selecting columns in the **Labels** section.
- Unused reactants can be marked.
- Select what you want to do with multiple matches.

A table of Products will be then displayed in a table called T_out. Columns in T_out labeled "rct" display which reactants were used to build the product.

Table of Products

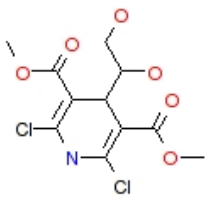
r_han_pyr		reactant1	reactant2	T_out
	mol	rct1	rct2	
1		1	1	Numbers indicate which reactant was used for the product

7.30 SAR Analysis

7.30.1 R-Group Decomposition

Tutorial | Video

To decompose a library into fragments based on a Markush scaffold (opposite of R-group (Markush) enumeration):

- Read the sdf file you wish to decompose into ICM and it will be displayed as a molecular table.
- Sketch the Markush structure you wish to use to decompose the table by and save it in a chemical table.

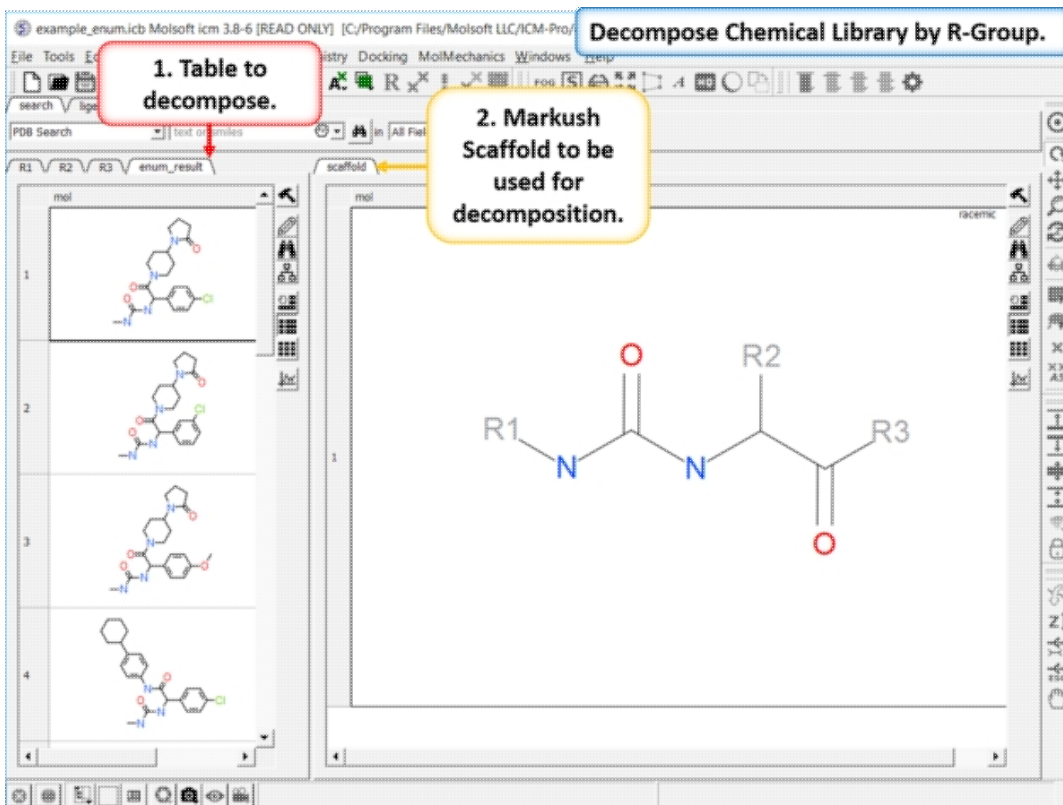

- **Chemistry/SAR Analysis/R-Group Decomposition.**
- Choose the table containing the Markush scaffold. Index refers to table row if you have more than one Markush structure in a table.
- Use the drop-down option to select the table you wish to decompose and the column containing the 2D chemical (usually called mol).
- If you have more than one R-group ICM can either generate a different table for each R-group or it can merge it into one single table whereby column will represent R1 and column two R2... This option is useful if you want to generate a SAR table with a column of activity data next to the R1 and R2 columns.
- If you check the box "Auto Add Missing R Groups" then unique R-groups will be extracted from the scaffold where hydrogens can be attached.

example_enum.icb Molsoft icm 3.8-6 [READ ONLY] [C:/Program Files/Molsoft L

Chemistry/SAR Analysis/R-Group Decomposition

File Tools Edit View Bioinfo Homology Chemistry Docking MolMechanics

search ligedit

PDB Search

R1 R2 R3

1. Chemistry/SAR Analysis/R-Group Decomposition.

2. Scaffold table

3. Table for decomposition.

4. Click OK.

R-Group Decomposition

Choose Table With Scaffold Draw New Scaffold

Scaffold Index 1

Table For Decomposition enum_result Structure Column mol

Generate Single SAR Table Auto Add Missing R-Groups Add Original Compounds

Ok Cancel Help

R1 R2 R3

- The decomposed table will be reported in a new table with new columns for the R groups (R1,R2...). If you have an additional column with activity data you can sort the table by R-groups and see the effect of an R-Group on activity. This table can be used to build an additional SAR table as described here.

example_enum.icb Molsoft icm 3.8-6 [READ ONLY] [C:/Program Files/Molsoft LLC/ICM-Pro/exam

R-Group Decomposition Results Table.

File Tools Edit View Bioinfo Homology Chemistry Docking MolMechanics Windows Help

search ligedit

PDB Search

R1 R2 R3 enum_result scaffold T_sar

	R1	R2	R3	mol	R1 ID1	R2 ID1	R3 ID1
1	C → *				ID9	ID2	ID3
2	C → *				ID9	ID2	ID1
3	C → *				ID9	ID2	ID5
4	C → *				ID9	ID2	ID2

7.30.2 SAR Table

|Tutorial|

To generate a SAR table you first need to decompose the table into the R-Groups.

The screenshot shows the Molsoft icm 3.8-6 software interface. A blue callout box at the top right contains the text "First decompose your table into R-Groups". The main workspace displays a SAR table with the following columns: R1, R2, R3, mol, and CS50 nR. The table contains four rows of chemical structures. The R1 column shows a carbon atom with an asterisk (C → *). The R2 column shows a propyl chain with a sulfur atom. The R3 column shows a piperidine ring. The mol column shows the full molecule with the R-groups highlighted. The CS50 nR column shows numerical values: 86, 95, 47, and 11. The bottom row has a value of 51. The left sidebar shows a tree view of tables: scaffold (1 row), R1 (11 rows, 3 columns), R2 (15 rows, 3 columns), R3 (8 rows, 3 columns), enum_result (13 rows), and T_sar (1320 rows). The script panel shows "SplitR" and "Enumerate" options.

	R1	R2	R3	mol	CS50 nR
1	C → *	<chem>CCCCS</chem>	<chem>C1CCNCC1</chem>	<chem>CCCCS(=O)N(C)C(=O)N1CCN(C1)C2CCNCC2</chem>	86
2	C → *	<chem>CCCCS</chem>	<chem>C1CCNCC1</chem>	<chem>CCCCS(=O)N(C)C(=O)N1CCN(C1)C2CCN(C2)C3CCNCC3</chem>	95
3	C → *	<chem>CCCCS</chem>	<chem>C1CCNCC1</chem>	<chem>CCCCS(=O)N(C)C(=O)N1CCN(C1)C2CCN(C2)C3CCN(C3)C4CCNCC4</chem>	47
4	C → *	<chem>CCCCS</chem>	<chem>C1CCNCC1</chem>	<chem>CCCCS(=O)N(C)C(=O)N1CCN(C1)C2CCN(C2)C3CCN(C3)C4CCN(C4)C5CCNCC5</chem>	11
					51

Decompose your library. Decompose the library to extract the R-Groups or read in a decomposed SDF file.

Chemistry/SAR Analysis/Generate SAR Tables

1. Chemistry/SAR Analysis/Generate SAR Tables

2. Select 2 or more columns for analysis.

3. Select the label column

4. Click OK

Generate SAR table. Chemistry/SAR Analysis/Generate SAR Tables. One or more columns can be chosen for analysis and multiple tables will be generated. Color the table by a selected column e.g. activity.

SAR Table.

	A	B R4	C	D	E	F
1	ACTIVITY scale R1/R4					
2	R1		ACTIVITY 8.43	ACTIVITY 8.33	ACTIVITY 8.24	AC 6.12 AC 6.12
3			ACTIVITY 6.89			ACTIVITY 7.82

SAR table. The SAR table will be displayed with an activity scale and R-group scaffold in the first cell (A1) and the R groups along each

axis. You can use the table to investigate which R-group(s) contribute to activity.

7.30.3 Plot R-Groups

You can make a plot of R-groups from library decomposition. This is described in the plots section of the manual.

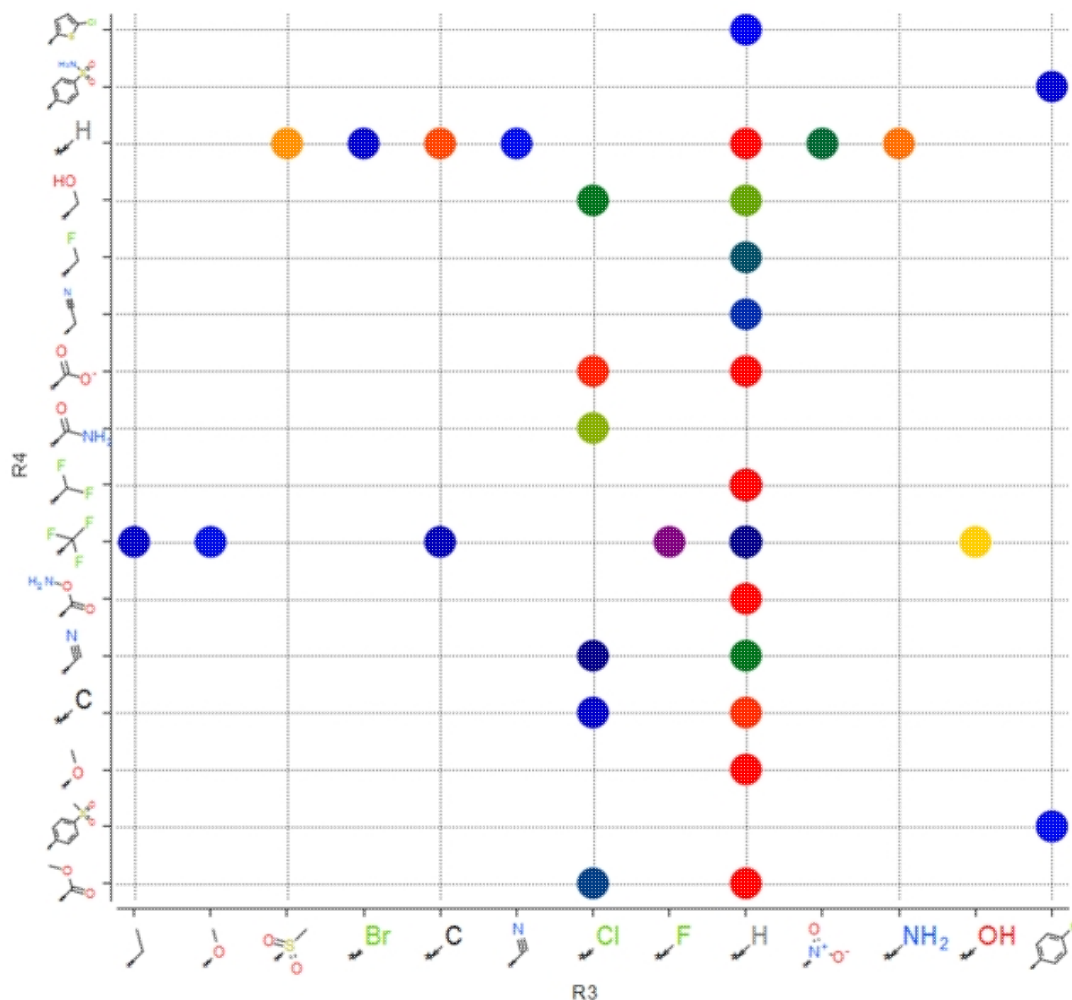

7.30.4 Generate SALI Table

| Tutorial |

Structure--activity landscape index: identifying and quantifying activity cliffs.

This method produces a SALI score as described in the publications by John Van Drie and co-workers. It will identify "structure-activity cliffs": pairs of molecules which are most similar but have the largest change in activity.

- Read in a sdf file containing "mol" and "activity" column.
- Chemistry/SAR Analysis/Generate SALI table.
- You can choose to use the Log of the Activity Column.
- The method will try to find pairs based on defined distance cutoff (0.15 is a good threshold for larger datasets).

- A results table will be reported containing the pairs, tanimoto fingerprint similarity and SALI index.

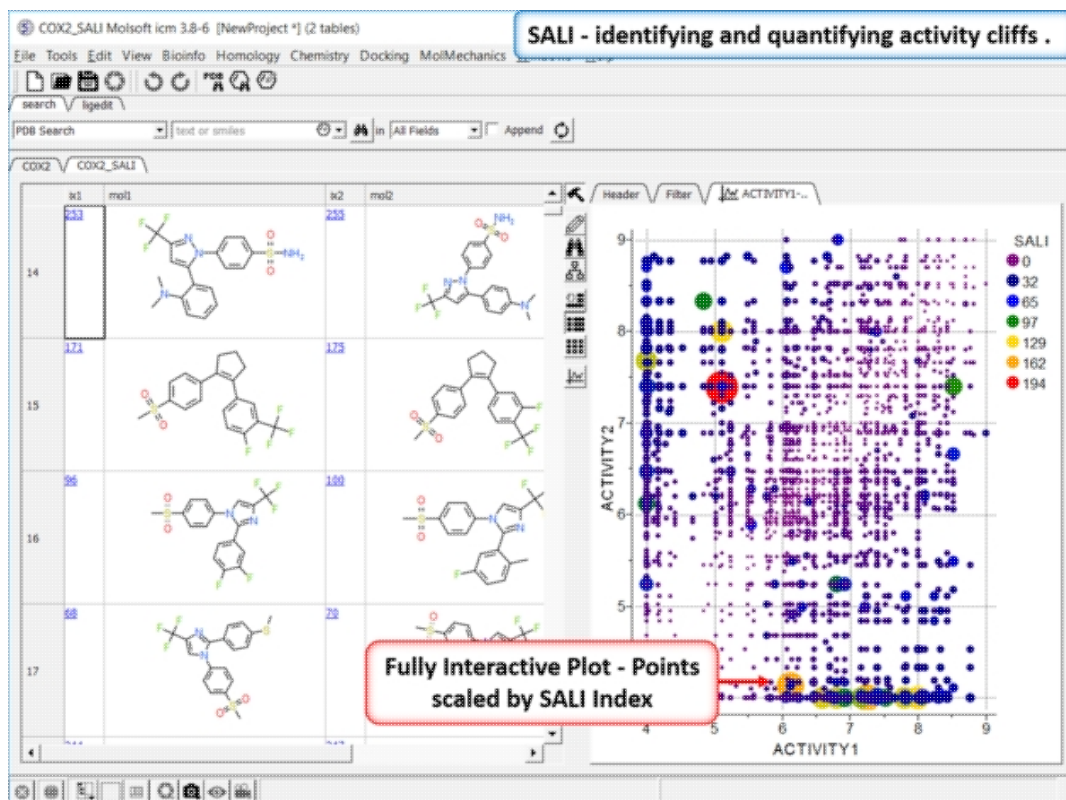

7.30.5 Matched Pair Analysis

| Tutorial |

Matched Pair Analysis (MPA) can be used to study changes in chemical properties based on small well-defined structural modifications to the chemical structure. The method tries to find the Maximum Common Substructure and clusters by similarity. The analysis is performed in two stages: clustering and then Maximum common substructure on each pair in each cluster. The output is similar to SALI output plus it gives the actual R-group pair variation. The pair table is sorted by score so top hits should show small variations and big score difference. To run MPA:

T_common Molsoft icm 3.8-6 [NewProject *] (2 tables)

Chemistry/SAR Analysis/Matched Pair Analysis

File Tools Edit View Bioinfo Homology Chemistry Docking MolMechanics W

search ligedit

PDB Search text or smiles in All Fields Append

COX2 COX2_pairs

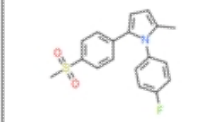
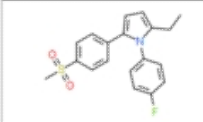
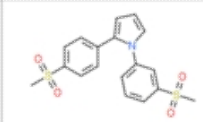
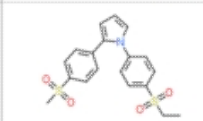
mol	Molecule	ACTIVITY	SET	Min dist	Avg dist	Header	Filter
						Name	Value
1		1-1					
2		1-10					
3		1-16					
4		1-17	4	3	0.19		0.56

Matched Pair Analysis

Input Table: COX2

Use Activity ActivityColumn: ACTIVITY

Cluster Split Distance: 0.50

Max Atoms in R-group: 12

Filter R Groups

-H -CH3 -NH2 -OH -F

-PH2 -SH -Cl -Br -I

-CF3

Custom Filter:

Ignore Chirality

Hint: Use Custom Filter field for additional groups

OK Cancel

- Read in a chemical spreadsheet containing a 'mol' column and activity data.
- Chemistry/SAR Analysis/Matched Pair Analysis.
- Enter the name of the Input Table.
- If the table has activity data or some other property use the option use Activity and select the column name from the drop down button.
- Enter a cluster split distance for determining similarity.
- The size of the R-groups for comparison can be set (default is 12 atoms).
- R-groups can be filtered from the analysis, or a custom filter using SMARTs.
- Chirality can be ignored in the comparison if needed.

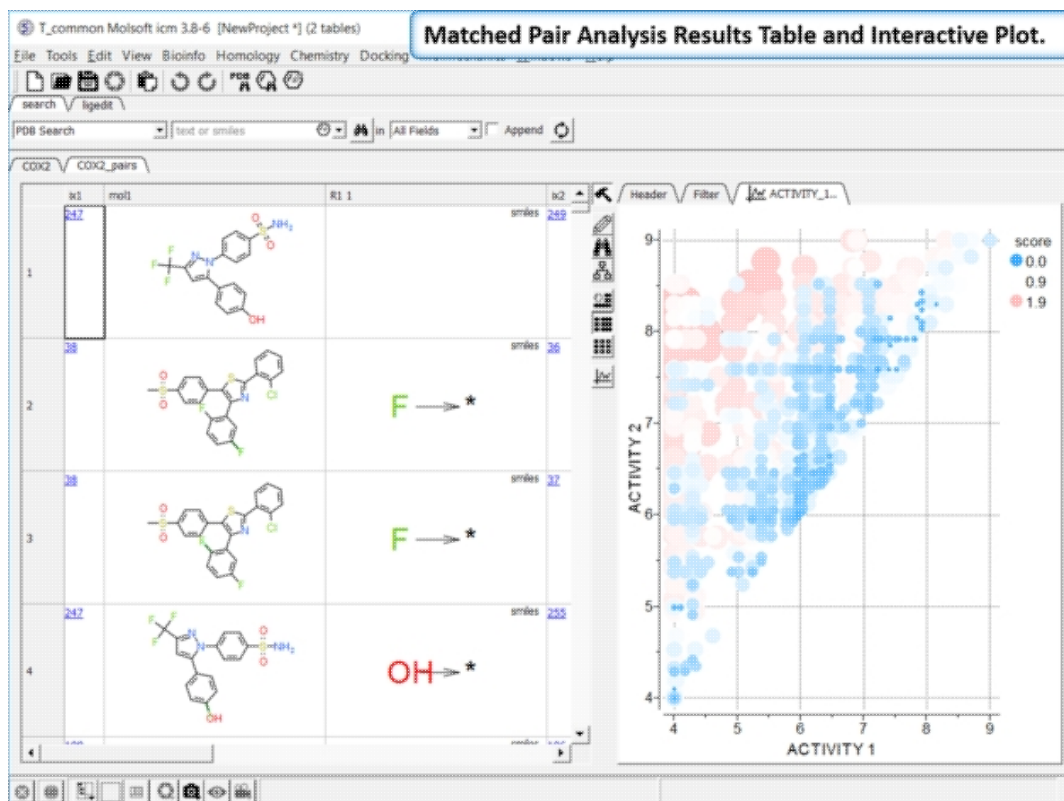

The results table (tableName_pairs) is fully interactive between the plot and the original table. The hits are sorted by the score column, so top hits should show biggest activity change with smaller groups. The plot is displayed activity 1 versus activity 2 colored and sized by score (red is better).

- **ix1** - index number (row number) of first chemical which is hyperlinked to original table.
- **mol1** - 2D structure of first chemical.
- **R1_1** - group difference between first (ix1) and second chemical (ix2).
- **ix2** - index number (row number) of second chemical which is hyperlinked to original table.
- **mol2** 2D structure of second chemical.
- **R1_2** - group difference between second (ix2) and first chemical (ix1).
- **scfl** - common scaffold
- **dvisible** ('d' delta 'visible' - delta of your activity column: 'd' + original_column_name)
- **score** is calculated as normalized dActivity + (1 - normalized weight of both groups).

8 Working with Tables and Plots

One of the easiest ways to store, sort and display data in ICM is by the use of a table. In most cases tables are automatically created, for example, if you search for a PDB file or when you load a compound database (SDF file). It is also possible for you to create your own table. Once a table is created, ICM provides easy to use tools to sort, add, edit and plot data.

Here we will concentrate on describing the actions you can perform on a table once it has been read into ICM. We will start by describing a simple table. Actions which can be performed on chemical tables are described in the section entitled *Working with Chemical Spreadsheets*.

- Standard ICM Tables
- Chemical Spreadsheets
- Insert Interactive Objects into Table Cell
- Plotting Table Data
- Principal Component Analysis
- Learn and Predict
- Cluster

A standard ICM table:

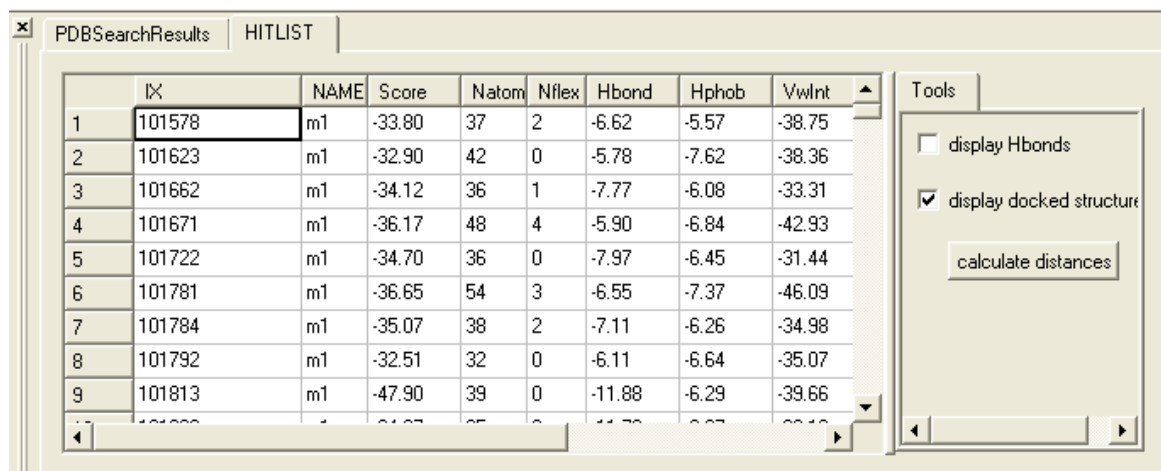

The screenshot shows a window titled 'PDBSearchResults HITLIST'. It contains a table with the following data:

	ID	NAME	Score	Natom	Nflex	Hbond	Hphob	VwInt
1	101578	m1	-33.80	37	2	-6.62	-5.57	-38.75
2	101623	m1	-32.90	42	0	-5.78	-7.62	-38.36
3	101662	m1	-34.12	36	1	-7.77	-6.08	-33.31
4	101671	m1	-36.17	48	4	-5.90	-6.84	-42.93
5	101722	m1	-34.70	36	0	-7.97	-6.45	-31.44
6	101781	m1	-36.65	54	3	-6.55	-7.37	-46.09
7	101784	m1	-35.07	38	2	-7.11	-6.26	-34.98
8	101792	m1	-32.51	32	0	-6.11	-6.64	-35.07
9	101813	m1	-47.90	39	0	-11.88	-6.29	-39.66

To the right of the table is a 'Tools' panel with the following options:

- display Hbonds
- display docked structure
- calculate distances

8.1 Standard ICM Tables

Available in the following product(s): ICM-Chemist | ICM-Chemist-Pro | ICM-VLS

8.1.1 Generate New Table

NOTE: To generate a new chemical table use the options in Chemistry/Create Empty Chemical Table.

To generate a new empty table:

- File/New and select the **Table** tab and a window as shown below will be displayed.
- Enter the number of rows and columns you wish to include in your table and whether you wish to add a column with chemical data.
- If you wish to make a chemical table (chemical spreadsheet) select the **Chemical Column** box.

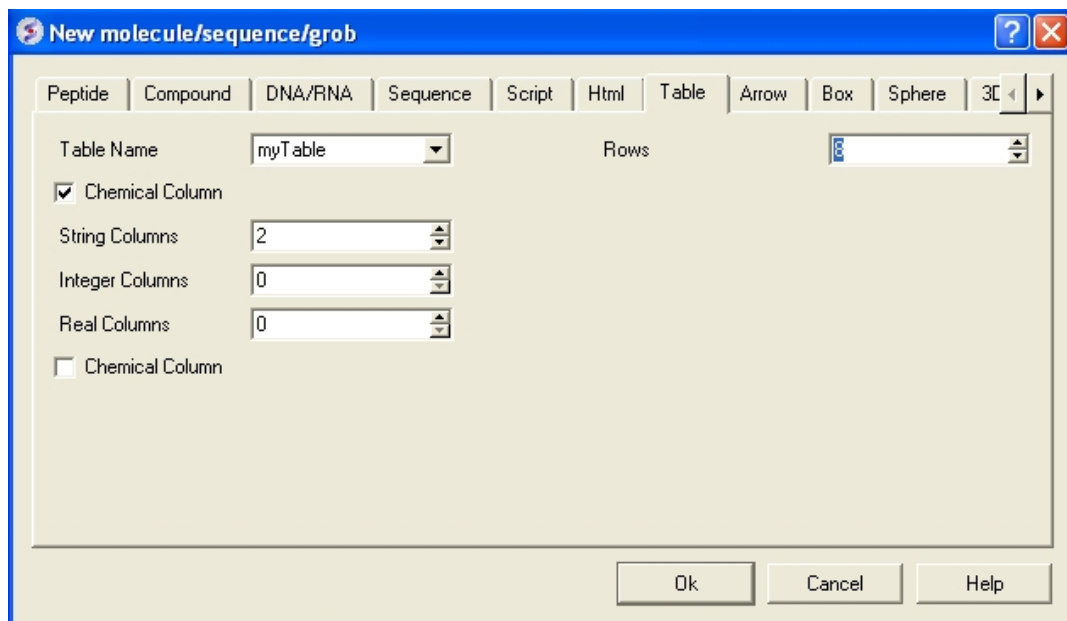

8.1.2 Reading a Table

A table can be read and saved as a *.csv , *.tsv or a .tab file. Saving or reading your table as a csv (comma separated value) file enables the table to be transferred or loaded from other applications such as Microsoft Excel. A chemical file such as an .sdf file can also be viewed as a chemical spreadsheet.

A table can be read into ICM by selecting:

- File/Open and then selecting the table you have saved (e.g. csv, sdf, tab).

NOTE: If you have loaded a table and it is not displayed it may be because the table window is hidden. To display the table, select the window menu and select table see the [Window Menu Section](#).

8.1.3 Saving a table

To save the whole table:

- To save a table right click on the table header tab and select Save As..

To save a row selection:

- Select a row(s)
- Right click and choose **Save Selection As** or **Save Selection As Csv + Headers**

8.1.4 Basic Table Navigation

To view the contents of a table you can move the table up and down using the scroll bars on the side and bottom of the display.

NOTE: If you have loaded a table and it isn't displayed it may be because the table display isn't selected. To select the table display,

select the window menu and select table (See Window Menu Section).

If you have read more than one table in ICM you can select a table by clicking the tab on the top of the table (See Below).

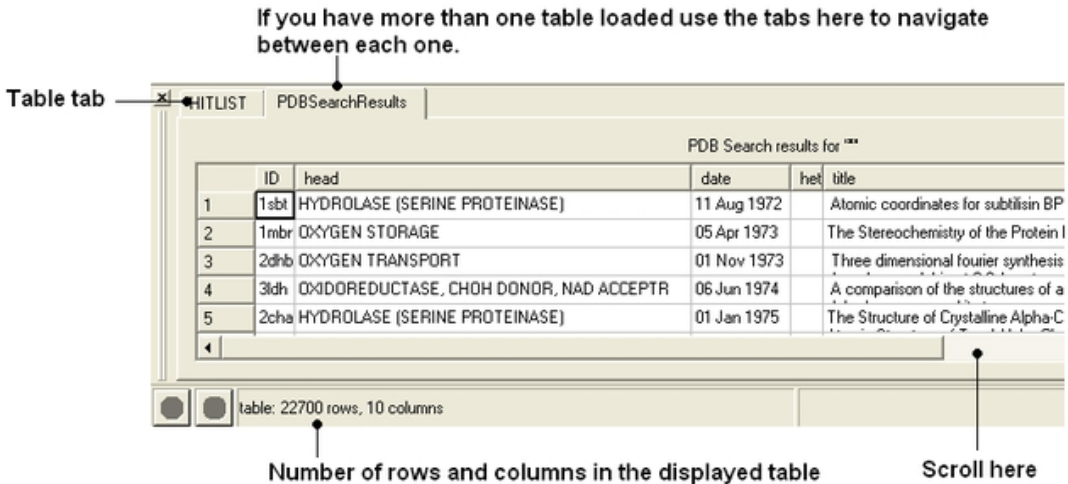

NOTE: Double clicking on the tab allows two tables to be displayed at once. Double clicking again returns to the default table layout.

NOTE: Information regarding the number of rows and columns within a table is displayed at the bottom of the table.

If you would like the table to be the main window in the graphical user interface:

- Select Windows/Table->Main

8.1.5 Table View (Grid Layout)

To change the table view (layout):

- Select the columns you wish to display in grid view. No selection will place all columns in grid view
- Right click on a table row and select **Table View**
- You can view the table in **Grid View** and toggle between grid and standard view. You can define your own grid using the **Custom Grid** option or display the table in **Form View**.

NOTE: You can save a table view.

8.1.6 Change Row Height

To change the row height:

- Click and drag on the row separator
- Hold the Ctl key to change the height of all rows.

8.1.7 Table View Save

Once you have a table view that you want to keep. You can save it by:

- Right click on a table row and select **Store Views**
- Select **Save Current View**
- Enter a name for the table view and you can return to that view by repeating the first two steps above.
- You can rename, delete or restore view by right clicking on the name of the table view.

8.1.8 Table Search

To search a table:

- Right click on a table row and select **Find and Replace**. You can also use CTRL F.
- Enter a search string.
- Press the **Find** button.

8.1.9 Table Color

You can color your table based on values within a column by:

Single Color

- Right click on the column header and select **Format,Color,Action**.
- In the **Background** panel select the color you desire using the option **Single Color**.

Color by Rainbow

- Right click on the column header and select **Format,Color,Action**.
- In the **Background** panel select the option **rainbow**. To edit the range of values relating to each color click on the pencil (edit) button as shown below.

The image shows a software interface with a table of data. A column is highlighted with a rainbow color gradient. Five callout boxes with arrows point to specific actions:

1. Right click and select format
2. Select rainbow
3. Click here to display color editor
4. Edit gradient by clicking and dragging line.
5. Right click here to edit color

Color Range - Advanced

- Right click on the column header and select **Format,Color,Action**.
- In the **Background** panel select the option **Range/Advanced**

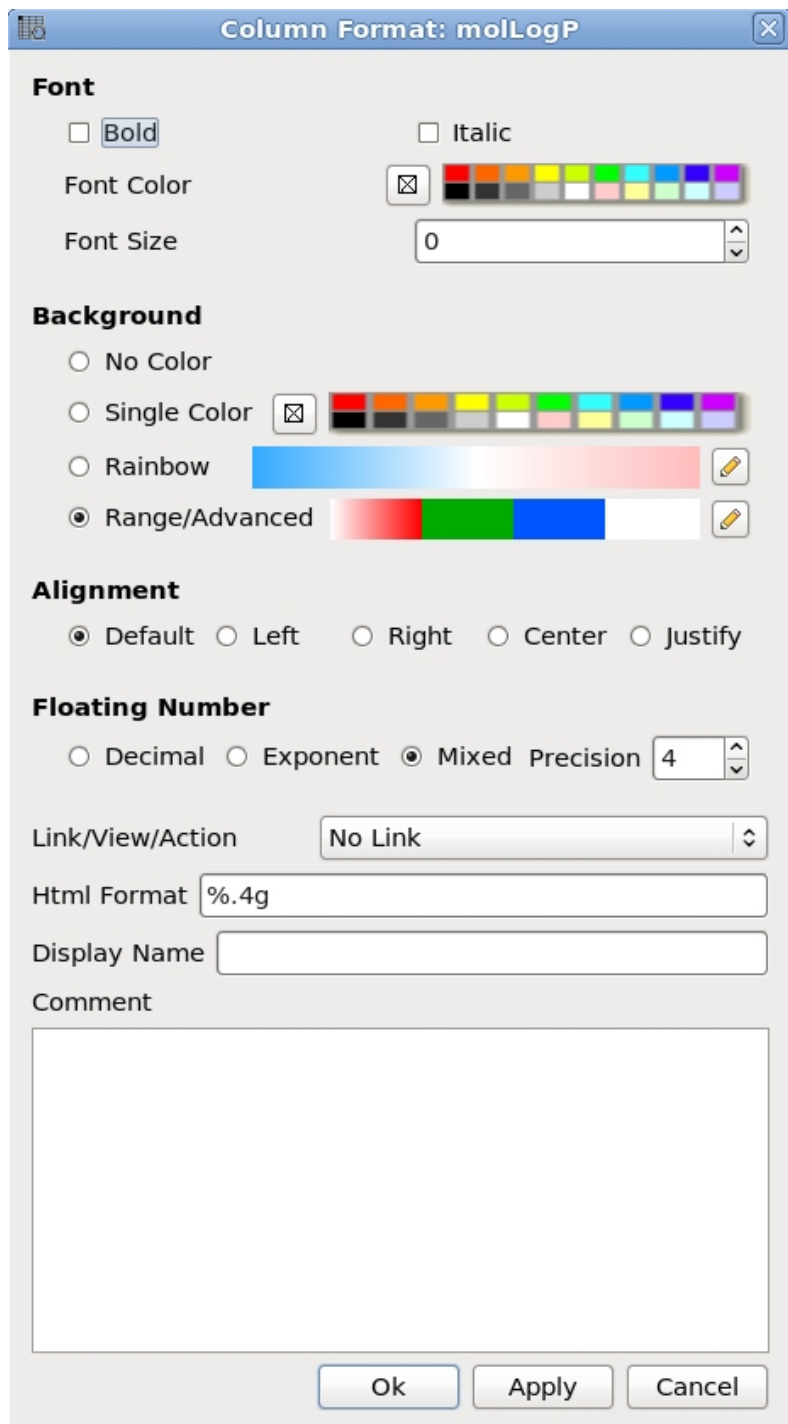

- A dialog as shown below will be displayed where you can specify ranges and colors for each range. If two colors for range are equal then the whole range will be colored with single color, otherwise color will be interpolated within the range.

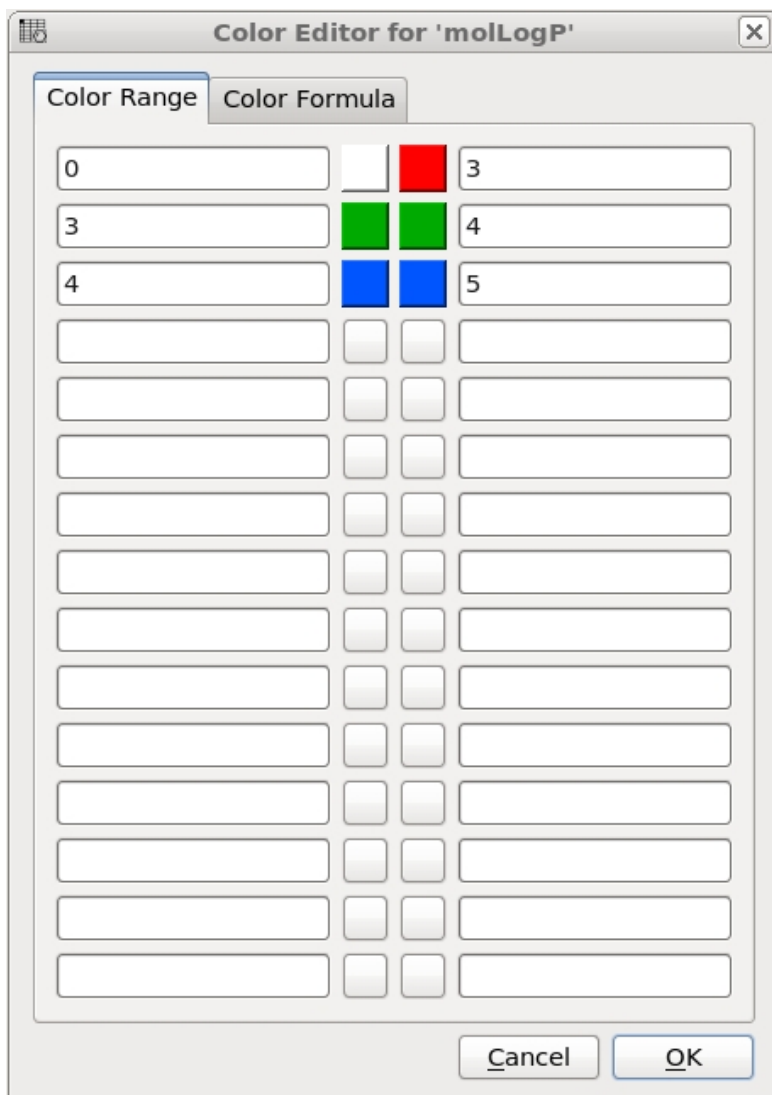

8.1.10 Table Font

- Right click on the column header and select **Format**.
- Change the font using the options in the **Font** panel.

8.1.11 Table Alignment

- Right click on the column header and select **Format**.
- Change the font using the options in the **Alignment** panel.

Rows can be colored by marking them as described [here](#)

8.1.12 Mark a Row

A row in a table can be marked and grouped by a label which enables the row(s) to be selected easily at a later time.

To mark a row

- Right click on the row in the table you wish to **mark**. Or select multiple rows and then right click.
- Select **Mark Row/** and then choose a number. In the GUI the number of rows that can be marked is limited to 5 but this can be

increased using the command line command.

- A row that is marked will be colored - each number is assigned a color. The coloring can be changed in the gui tab in preferences.

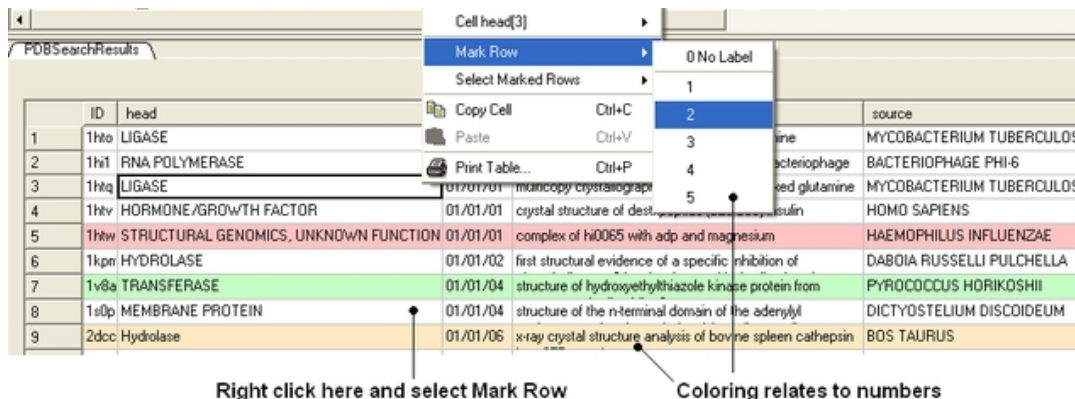

To select marked rows

- Right click on the table and choose **Select Marked Rows** and choose a number which relates to the marked rows as described earlier.
- Selected rows will be highlighted blue - once rows are selected a number of right click options are activated such as copy selection to new ICM table.

8.1.13 Table right click options

Right-click options vary according to where you click and what is selected. The options are intuitive, for example options that are performed on the whole table (eg Save and Delete) are performed by right-clicking on the Table tab. Other right-click options vary according to whether the row or column is selected or not.

8.1.14 Rename a Table

To rename a table:

- Right click on the table tab and select rename.
- Enter a new name and select OK.

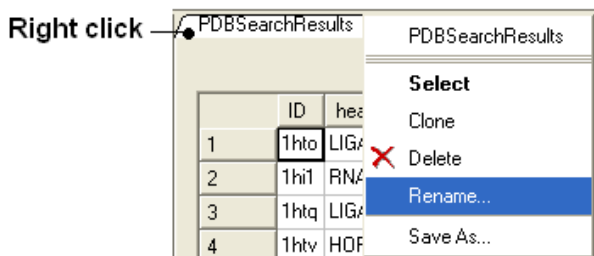

8.1.15 Clone a Table

- Right click on the table tab and select clone.

8.1.16 Delete a Table

- Right click on the table tab and select delete.

8.1.17 Page Setup

Before printing a table you can change the orientation and scale.

To do this:

- Right click on the table header and select **Page Setup**.

8.1.18 Print a Table

A table can be printed by:

- Right click on the table tab and a menu will be displayed.
- Select the "Print" option. You may want to change the setup of the table (eg orientation and scale. You can do this using Page Setup option.

8.1.19 Export to Excel

To export a table to excel.

- Right click on the table header.
- Select the option to **Export to Excel**.

8.1.20 Save a Table

- Right click on the table tab and select Save As..

NOTE: You can save your table in comma separated format if you want to read it into another program such as Microsoft Excel.

8.1.21 Change Column and Row Width

To change the width of column and rows:

You can change the width of a row or column by clicking on the separating line and dragging. You can make each row the same width by holding down the **Shift** key and dragging one of the row edges.

8.1.22 Making Table Selections

To select one column of a table:

- Click on the column header

Click here to select a column

The screenshot shows a table with 5 rows and 5 columns. The columns are labeled 'ID', 'head', 'date', 'het', and 'title'. The rows contain search results for various enzymes and proteins. A callout line points from the text 'Click here to select a column' to the 'head' column header.

	ID	head	date	het	title
1	1sbt	HYDROLASE (SERINE PROTEINASE)	11 Aug 1972		Atomic coordinates for subtilisin BPN
2	1mbr	OXYGEN STORAGE	05 Apr 1973		The Stereochemistry of the Protein M
3	2dhh	OXYGEN TRANSPORT	01 Nov 1973		Three dimensional fourier synthesis c
4	3ldh	OXIDOREDUCTASE, CHOH DONOR, NAD ACCEPTR	06 Jun 1974		A comparison of the structures of ap
5	2cha	HYDROLASE (SERINE PROTEINASE)	01 Jan 1975		The Structure of Crystalline Alpha-Ch

table: 22700 rows, 10 columns

To select one row of a table:

- Click on the row header

The screenshot shows the same table as above, but with the third row (ID: 2dhh) selected. The status bar at the bottom now reads 'table: 22700 rows, 10 columns (1 selected records)'. A callout line points from the text 'To select a row click here' to the 'ID' cell of the selected row.

	ID	head	date	het	title
1	1sbt	HYDROLASE (SERINE PROTEINASE)	11 Aug 1972		Atomic coordinates for subtilisin BPN
2	1mbr	OXYGEN STORAGE	05 Apr 1973		The Stereochemistry of the Protein M
3	2dhh	OXYGEN TRANSPORT	01 Nov 1973		Three dimensional fourier synthesis c
4	3ldh	OXIDOREDUCTASE, CHOH DONOR, NAD ACCEPTR	06 Jun 1974		A comparison of the structures of ap
5	2cha	HYDROLASE (SERINE PROTEINASE)	01 Jan 1975		The Structure of Crystalline Alpha-Ch

table: 22700 rows, 10 columns (1 selected records)

To select a row click here

To select more than one row or column:

- Click on one row or column whilst pressing the Ctrl key
- Select multiple number of rows or columns whilst still pressing the Ctrl key

HITLIST | PDBSearchResults

PDB Search results for "..."

	ID	head	date	het	title
1	1sbt	HYDROLASE (SERINE PROTEINASE)	11 Aug 1972		Atomic coordinates for subtilisin BPN
2	1mbr	OXYGEN STORAGE	05 Apr 1973		The Stereochemistry of the Protein M
3	2dhb	OXYGEN TRANSPORT	01 Nov 1973		Three dimensional fourier synthesis
4	3ldh	OXIDOREDUCTASE, CHOH DONOR, NAD ACCEPTR	06 Jun 1974		A comparison of the structures of ap
5	2cha	HYDROLASE (SERINE PROTEINASE)	01 Jan 1975		The Structure of Crystalline Alpha-Cr

table: 22700 rows, 10 columns (3 selected records)

Select multiple rows and columns by clicking and selecting whilst pressing the Ctrl key.

NOTE: The Ctrl key acts as a toggle enabling select and unselect.

To select a range of columns or rows:

- Click on the first row or column in the range whilst pressing the Shift key.
- Click on the last row or column in the range whilst pressing the Shift key.

To select a range of columns or rows - click on the first member of the range and the last whilst pressing the shift key.

HITLIST | PDBSearchResults

PDB Search results for "..."

	ID	head	date	het	title
7	3lyz	HYDROLASE (O-GLYCOSYL)	01 Feb 1975		Real-space refinement of the struct
8	1lyz	HYDROLASE (O-GLYCOSYL)	01 Feb 1975		Real-space refinement of the struct
9	6lyz	HYDROLASE (O-GLYCOSYL)	01 Feb 1975		Real-space refinement of the struct
10	5lyz	HYDROLASE (O-GLYCOSYL)	01 Feb 1975		Real-space refinement of the struct
11	2lyz	HYDROLASE (O-GLYCOSYL)	01 Feb 1975		Real-space refinement of the struct
12	1chg	HYDROLASE ZYMOGEN (SERINE PROTEINASE)	01 Mar 1975		Chymotrypsinogen; 2.5-angstrom cr
13	2cna	LECTIN (AGGLUTININ)	01 Apr 1975		The covalent and three-dimensiona
14	1hip	ELECTRON TRANSFER (IRON-SULFUR PROTEIN)	01 Apr 1975		Two-Angstrom crystal structure of o
15	1gpd	OXIDO-REDUCTSE(ALDEHYDE/DONR,NAD/ACCPT)	01 Jul 1975		Studies of asymmetry in the three-di

table: 22700 rows, 10 columns (6 selected records) 1 non-ICM

Click here hold the shift key

Click here hold the shift key

To invert a selection:

- Right click on the original selection and a menu will be displayed.
- Select the Row Selection/Invert selection option.

NOTE: Invert selection can only be used on rows.

To select the whole table:

- Right click in the table and a menu will be displayed.
- Select the Row Selection/Select All option.

To remove a selection:

- Click anywhere within the table.

A selection can also be made from a plot select('table-plot{See Select plot section}).

8.1.23 Editing a Table

To edit a table: Click on the Edit Cells by Double Click button on the right hand side of the table. You can then edit each cell by double clicking on it.

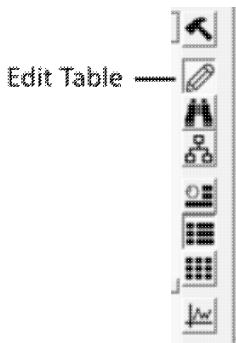

OR

To edit the text or values within a cell:

- Right click on the table and select **Edit Cells by Double-click**.

8.1.24 Rename Column

To edit the name of a column:

- Right click on the column header and a menu will be displayed.
- Select the option "Rename Column..." and enter the appropriate new text.

8.1.25 Inserting Columns

To insert a column:

- Identify the position within the table where you wish the column to be inserted.
- Right click on the column header and a menu will be displayed.
- Select "Insert Column"

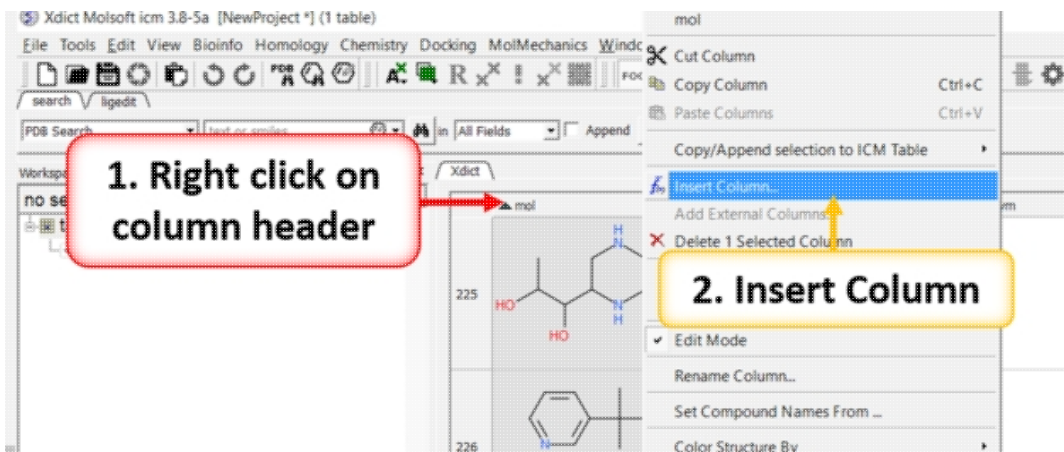

A dialog box will then be displayed as shown below.

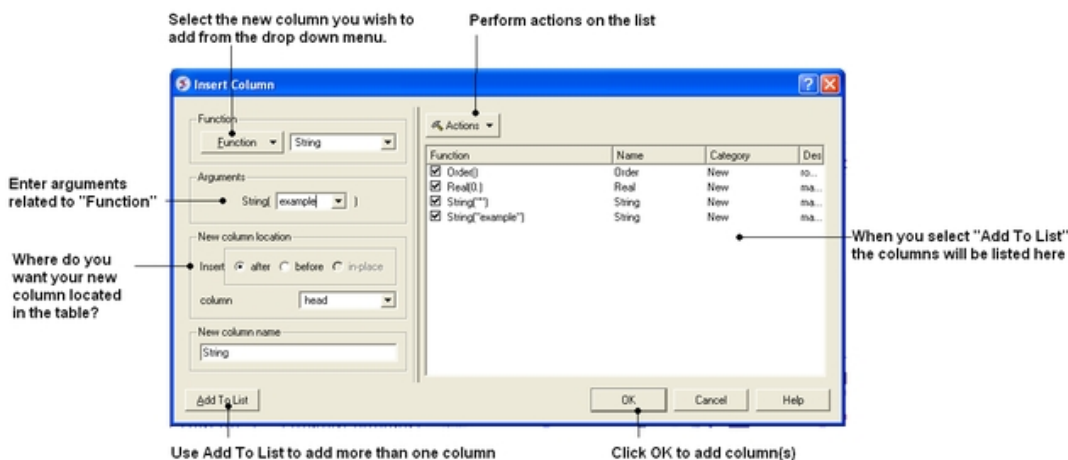

- Select the function you wish to add to the new column. Functions can be applied to many columns e.g. add etc..
- A set of arguments related to the function selected will then be displayed.
- Enter the appropriate arguments related to the function selected.
- Select where you want the new column to be located in the table.
- Enter the new column name
- If you wish to add multiple columns then use the **Add to List** option.

Many different functions are available:

- **New** Add a new column containing a real number, integer, string, or random number.
- **Transformations** A number of transformations can be selected and applied to a table column as shown below.
- **Mathematical** A number of mathematical functions
- **Text** Apply a number of different functions to the text in a column.
- **Chemical** Calculate a number of different chemical properties.
- **Convert Units** Radian to Degrees and Degree to Radian

Once the function and the correct arguments have been entered:

- Select whether you wish the new column to be added before, after, or in place of this column.
- Enter the name of the new column.

NOTE: If you want to add more than one column choose **Add to List** and the action will be added to a list on the right hand side of the dialog box.

8.1.26 Increment ID Number

To add and Increment name ID in cell as a column (e.g. mol1, mol2, mol3âf):

- Right click on a column and choose **Insert Column**.
- Select **Function New -> ID**.
- Enter name and starting number and press OK.

8.1.27 Column Visibility

To hide a column:

- Right click on any column header and choose "Manage Column Visibility and Order"
- A dialog box as shown below will be displayed.
- Click on the arrows to move a column from hidden to visible and vice-versa. Multiple columns can be selected by holding the Ctrl key and clicking.

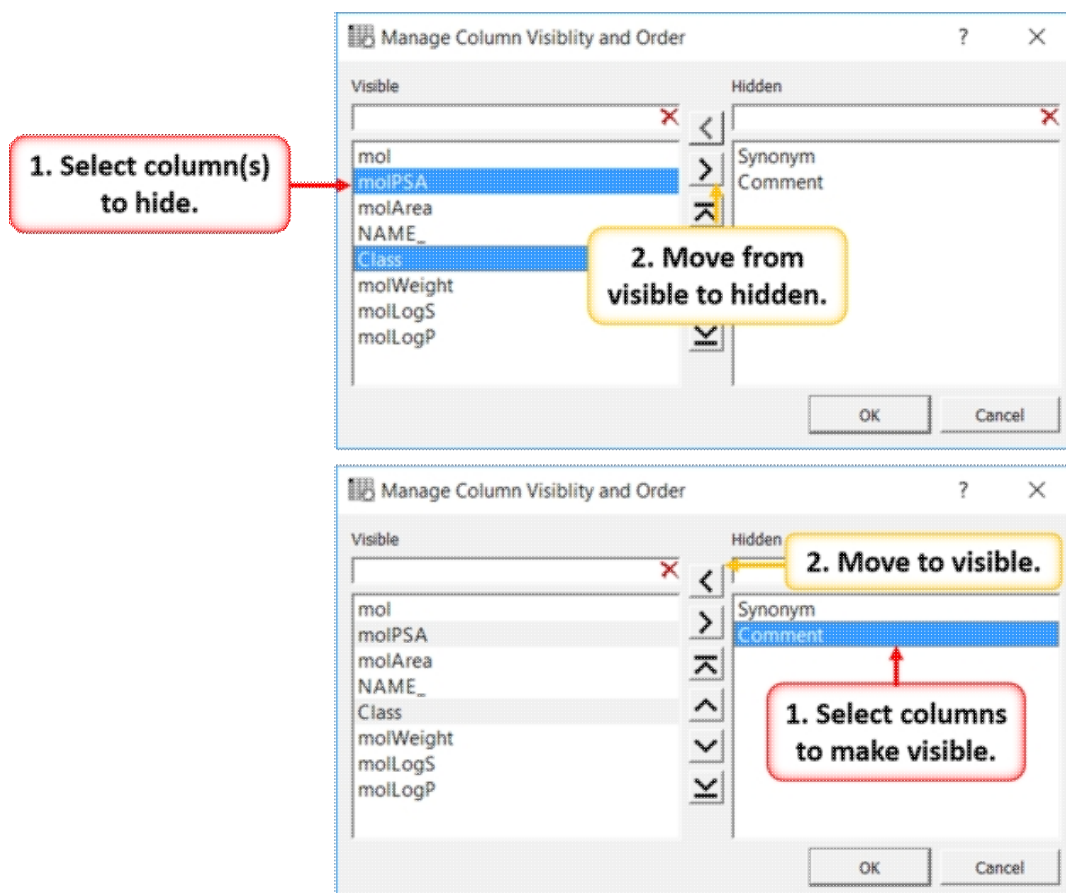

8.1.28 Column Order

To re-order the columns in a table:

- Right click on any column header and choose "Manage Column Visibility and Order"
- A dialog box as shown below will be displayed.
- Click on the arrow buttons to re-order. Multiple columns can be selected by holding the Ctrl key and clicking.

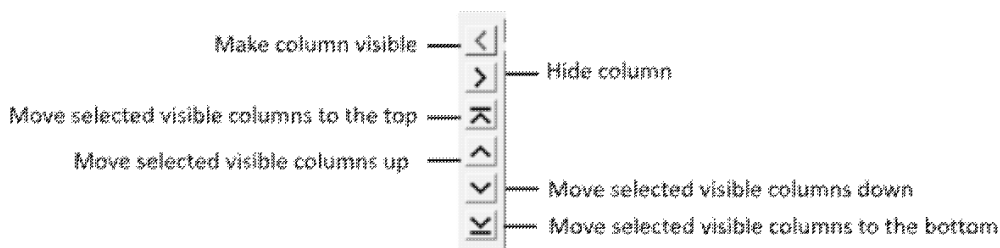
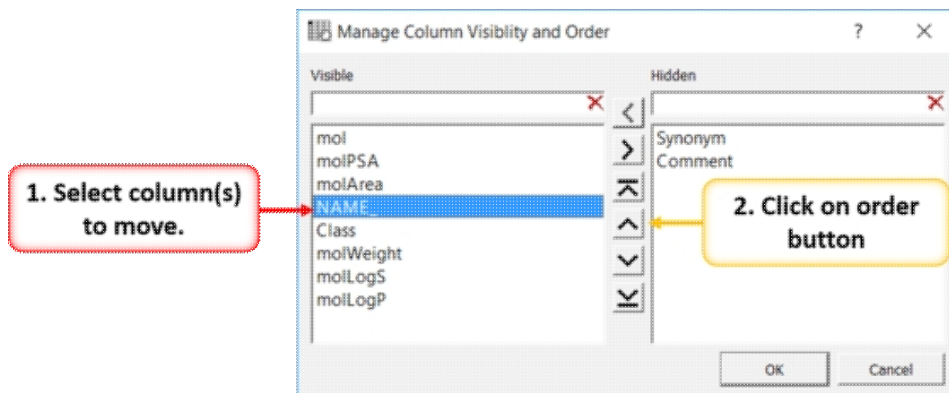

8.1.29 Freeze Column

NOTE One application of Freeze column is to rename rows.

To freeze a column:

- Right click on the column you wish to freeze and select **Freeze Column**.

To unfreeze a column:

- Right click on the column you wish to unfreeze and select **Unfreeze Column**.

8.1.30 Freeze Row

To freeze a row:

- Right click on the row number of the row you wish to freeze and select **Freeze Row**.

To unfreeze a row:

- Right click on the row number of the row you wish to unfreeze and select **Unfreeze Row**.

8.1.31 Column Statistics

To calculate various statistics describing columns and inter-column relationship:

- Right click on the column header and a menu will be displayed.
- Select "Column Statistics"

The output is printed into the ICM Terminal window and the Column Statistics Window.

8.1.32 Inserting Rows

To insert a row:

- Identify the position within the table where you wish the row to be inserted and select the row.
- Right click on the row name (eg the number of the row) and a menu will be displayed.
- Select **Insert Row Before or Insert Row After**.

A blank row will be inserted. You can add data to this row by following the instructions in the edit table section.

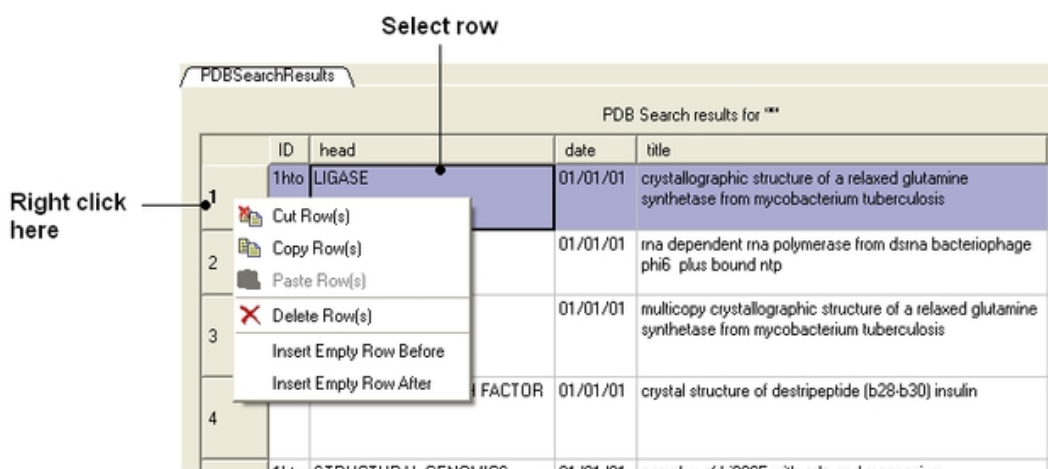

8.1.33 Insert Image

To insert an image into a table:

- First create an image column in the table. Use the Insert Column option and choose Function > New > Image.
- Right click on a cell in the new image column you have created and choose **Set Image** and choose the image you wish to import.

8.1.34 Copy Cut and Paste Row

Copy, Cut and Paste Row:

- Select the row(s) See table selection section.
- Right click on the row header
- Select **Copy Row(s)**.
- To paste a row select the row header under which you wish to paste the row. Right click and select **Paste Row(s)**

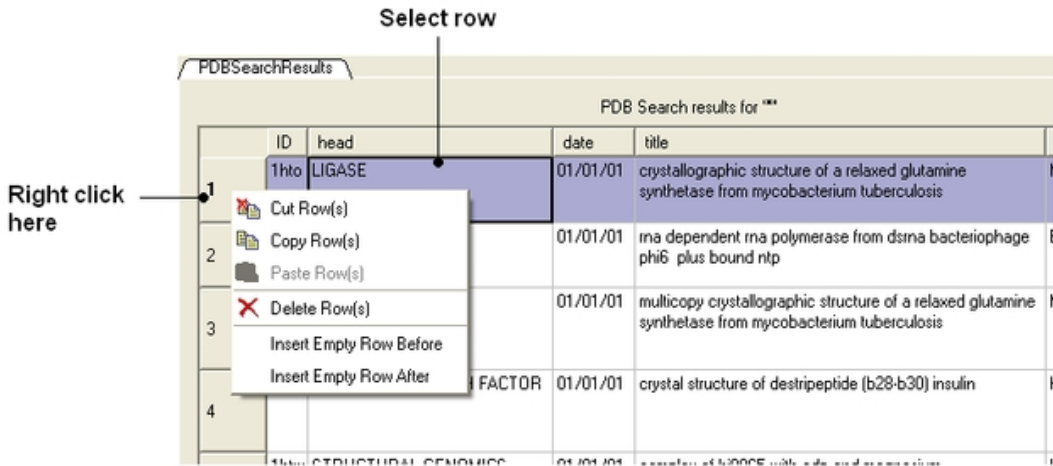

8.1.35 Copy Cell

To copy a table cell:

- Right click on cell.
- Select Copy Cell - you can then paste it into a new table.

8.1.36 Copy Selection to an ICM Table

To copy a selection to a new table:

- Select the row(s) See table selection section.
- Right click on the row header
- Select **Copy Selection to ICM Table** and then choose Auto (ICM will name the table or New and you can enter a new table name).

8.1.37 Deleting Columns and Rows

To delete a column or row:

- Select the column(s) or row(s) you wish to delete. See the select table section for information on how to make table selections.
- Right click on the row number to delete a row or right click on the column header to delete a column and select the delete option from the menu.

8.1.38 Hide and Show Columns

If you have a large table you may wish to only show and display certain columns and hide others. By default any loaded table will have all the columns displayed.

To select which columns you wish to hide:

- Select the column(s) you wish to hide. See the select table section for information on how to make table selections.
- Right click and select the hide option from the menu.

IX	NAME	Score	Natom	Nflex	Hbond	Hphob	Vwlnt	Eintl
103476	m1	-35.47	33	0	-8.31	-4.97	-33.81	1.49
103485	m1	-44.18	36	1	-10.40	-7.35	-34.44	5.61
103522	m1	-36.40	46	1	-6.74	-7.44	-38.30	1.01
103526	m1	-37.21	31	1	-11.60	-5.32	-34.68	9.26
103547	m1	-33.21	36	0	-7.53	-5.89	-33.12	1.13
103566	m1	-35.13	49	4	-5.13	-7.93	-44.10	4.48

able: 12923 rows, 13 (of 14) columns

- Hide
- Column histogram
- Rename ...
- Delete column(s)
- Color By
- Insert column after ...
- Insert column before ...
- Sort
- Filter

Select column(s), right click and then select the hide option.

To show hidden columns:

- Right click on the column header and a menu will be displayed.
- Select the **Show Columns** options.
- Select which column you wish to show from the drop down list.

IX	NAME	Score	Natom	Nflex	Hbond	Hphob	Vwlnt	Eintl	FILE	POS
103476	m1	-35.47	33	0	-8.31	-4.97	-33			
103485	m1	-44.18	36	1	-10.40	-7.35	-34			
103522	m1	-36.40	46	1	-6.74	-7.44	-38			
103526	m1	-37.21	31	1	-11.60	-5.32	-34			
103547	m1	-33.21	36	0	-7.53	-5.89	-33			
103566	m1	-35.13	49	4	-5.13	-7.93	-44			
103592	m1	-36.01	47	2	-4.39	-7.99	-49			
103614	m1	-36.25	41	5	-8.71	-5.47	-29			
103615	m1	-34.95	49	1	-7.84	-7.68	-38			
103621	m1	-34.46	31	0	-6.87	-5.01	-39.21	2.08	9.51	
103626	m1	-32.70	34	0	-7.00	-4.72	-35.59	2.15	6.61	
103648	m1	-36.11	31	3	-7.40	-5.63	-35.08	4.93	2.93	
103707	m1	-32.11	50	4	-5.91	-7.89	-49.16	2.12	16.18	

table: 12923 rows, 10 (of 14) columns

- Hide
- Rename ...
- Delete column(s)
- Color By
- Insert column after ...
- Insert column before ...
- Sort
- Show columns
 - All
 - Dsolv
 - mfScore
 - FILE
 - POS
- Filter

Note: In versions 3.8-6 and higher there is an option called "Manage Column Visibility and Order" as described here .

8.1.39 Column Format and Custom Actions

To change the **column format**, **font** color or size, the **alignment** of the column data, the background color, add hyperlink, or script:

- Right click on the column header and select **Format**

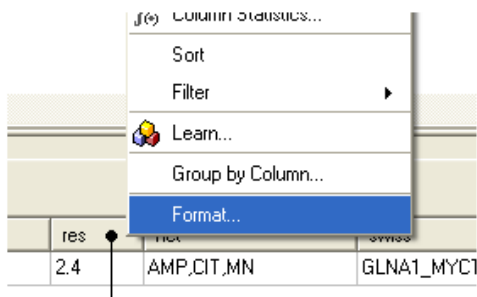

Right click on the column header

- A window as shown below will be displayed.
- Make the desired changes and click **Apply**

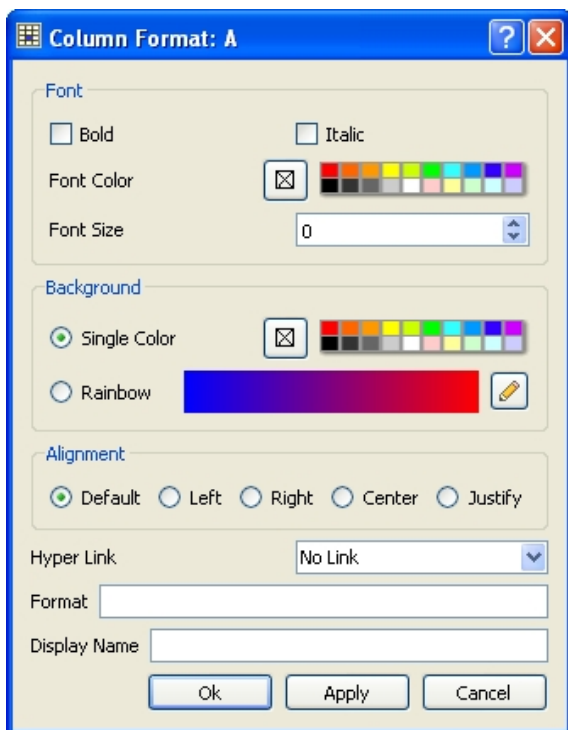

To add a hyperlink to PubMed, PDB or Uniprot:

- Click on the drop down hyper link button.
- If the data in the column is a **PDB, Uniprot/SwissProt** or **PubMed** code then choose the built in format from the menu.
- Click Apply and the data in the column will become blue hyperlinks.

To add a user-defined hyperlink:

- Click on the drop down hyperlink button.
- Choose "Simple link" See below for details on how to access cell data.
- Click Apply and the data in the column will become blue hyperlinks.

To add an internal ICM link:

- Click on the drop down hyperlink button.
- Choose "Internal ICM link" See below for details on how to access cell data.

- Enter ICM scripting language in the panel that opens (see image below).
- Click Apply and the data in the column will become blue hyperlinks.

The value of the clicked cell is accessed as %1. To refer to the other cells and/or table itself the following shortcuts can be used:

- %@ # table name
- %%# # clicked row number
- %^ # clicked column number

Example:

To add a an internal ICM link that reads a pdb file and then displays it you could use the following ICM commands in the link:

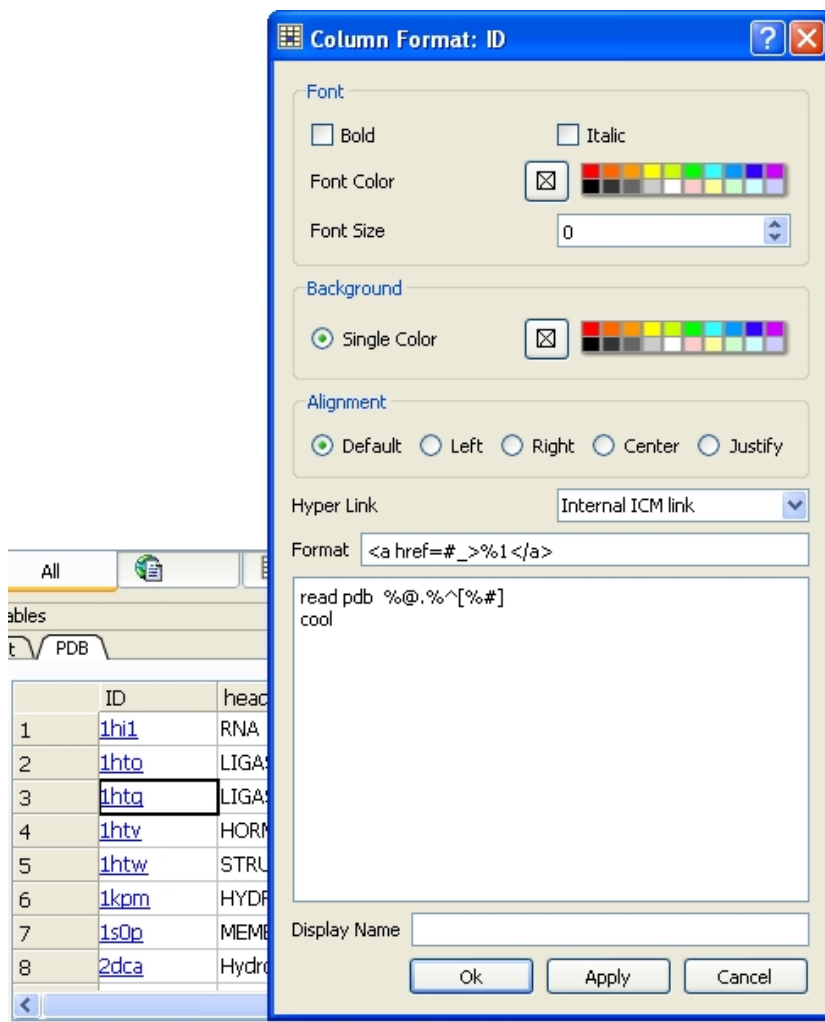

8.1.40 Column Table Annotation

- Right click on the column you wish to annotate and choose **Format, Color Action**.
- Enter the comment in the bottom panel labeled **Comments**.
- The comments will be displayed when the user hovers the mouse over the column header. Other table comments can be added using the HTML panel.

8.1.41 Table Sorting

To sort a table by a column value:

- Right click on the column header.
- Select the **Sort** option.

ID	head	date	hel	title
1uot	REGULATOR OF COMPLEMENT PATHWAY	23 Sep 2003	Hide	& 4
1r1c	ELECTRON TRANSPORT	23 Sep 2003	Column histogram	NOSA
1o5j	UNKNOWN FUNCTION	19 Sep 2003	Rename ...	F PERIPLASMIC DIVAL
1o5h	STRUCTURAL GENOMICS, UNKNOWN FUNCTION	17 Sep 2003	Delete column(s)	F PUTATIVE SERINE C
1o5i	OXIDOREDUCTASE	17 Sep 2003	Insert column after ...	F 3-OXODACYL-(ACYL
1qzr	ISOMERASE	17 Sep 2003	Insert column before ...	F THE ATPASE REGIO
1qyq	LUMINESCENT PROTEIN	11 Sep 2003	Sort	F THE CYCLIZED S65C
1qyo	LUMINESCENT PROTEIN	11 Sep 2003	Filter	ION INTERMEDIATE
1qys	IMMUNE SYSTEM	10 Sep 2003		M82R2 COMPLEXED

Right click in the column header

The arrow represents ascending or descending order.

8.1.42 Table Filtering

| Video |

There are two ways to filter table content one is via the table panel or by using the right click column header options.

To filter a table using the extra panel sliders:

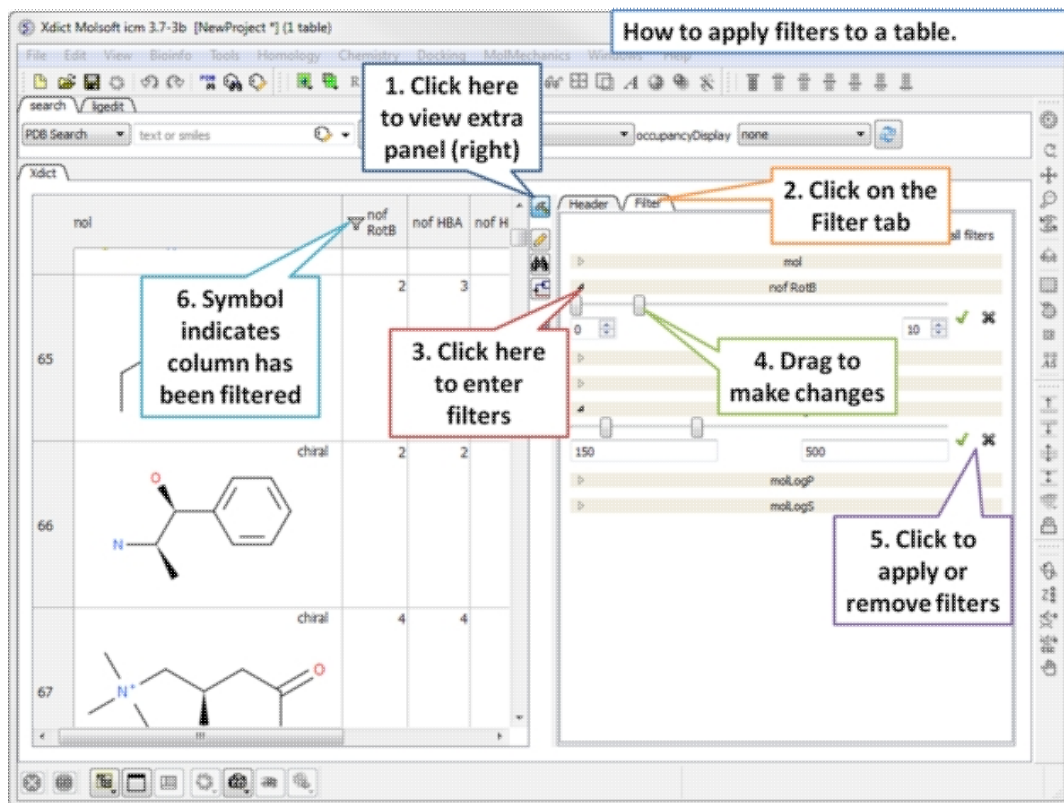

Open the extra panel and choose the filter tab. Click and drag on the sliders to conveniently choose the filtering values or enter the values directly. Click on the green 'tick' to apply filters.

To filter a table using the column header:

- Select the column you wish to filter. See the `select` table section for information on how to make table selections.
- Right click on the column header.
- Select the **Filter** option.

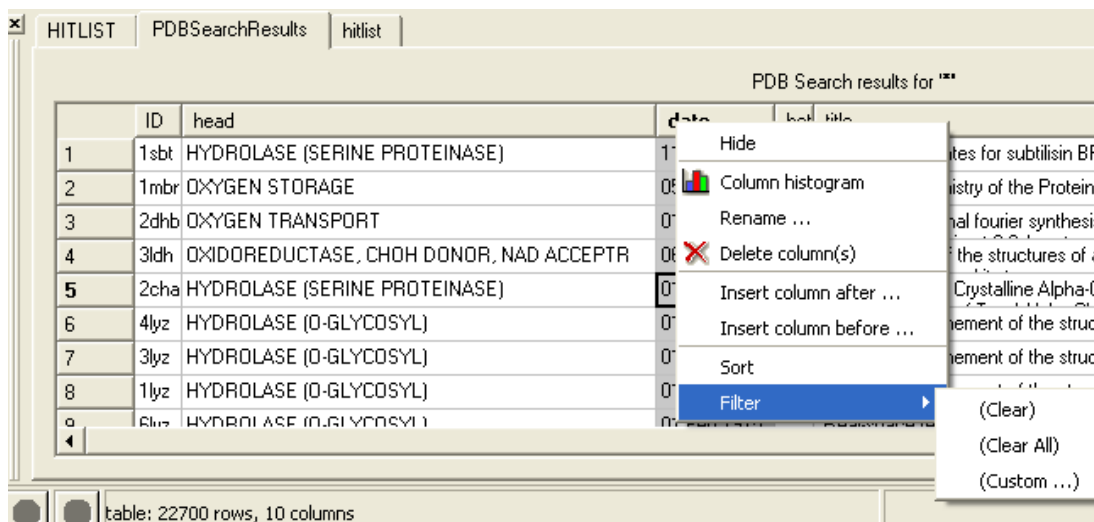

- Select the "Custom" option and a data entry box as shown below will be displayed.
- Enter the appropriate operations and filter values for your search.
- Click OK.

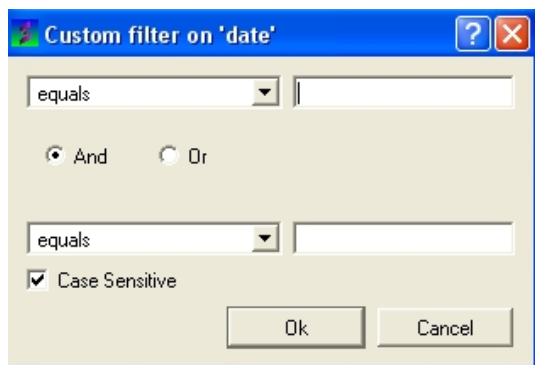

NOTE: When a column has been filtered a symbol as shown below will appear in the header of the column.

HITLIST PDBSearchResults hitlist

PDB Search results for ""

	ID	head	▼ date	het	title
	21260	1njo RIBOSOME	02 Jan 2003	PPL	THE CRYSTAL STRUCTURE OF '...
	21261	1njt HYDROLASE	02 Jan 2003	ACE	COMPLEX STRUCTURE OF HCM'...
	21262	1njs TRANSFERASE	02 Jan 2003		HUMAN GAR TFASE IN COMPLE>...
	21263	1njq METAL BINDING PROTEIN	02 Jan 2003	ACE	NMR STRUCTURE OF THE SING...
	21264	1njp RIBOSOME	02 Jan 2003	PPL	THE CRYSTAL STRUCTURE OF '...
	21265	1nju HYDROLASE	02 Jan 2003	DNI	COMPLEX STRUCTURE OF HCM'...
	21266	1oa7 HYDROLASE	02 Jan 2003		STRUCTURE OF MELANOCARPL...
	21267	1oa6 HYDROLASE INHIBITOR	02 Jan 2003		THE SOLUTION STRUCTURE OF...
	21268	1oa5 HYDROLASE INHIBITOR	02 Jan 2003		THE SOLUTION STRUCTURE OF...

table: 1441 (of 22700) rows, 10 columns

This symbol means that the table has been filtered according to data within this column.

To append the filtered information into a new table:

- Select the whole table either by right clicking or pressing Ctrl A.
- Right click on the table and select "Append to other table".
- Enter a new name for the table you are appending with your filter results.

OR

Selected rows can be appended to a new table by:

- Right clicking on the selected rows and a menu will be displayed.
- Selecting the "copy selection to ICM table" option.

A table can be filtered by a cell value:

- By clicking once in a cell.
- Right click and a menu will be displayed.
- Select the option "Filter by cell value".

A filter can be cleared by:

- Right clicking on the column selection and selecting Filter/Clear or Filter/Clear All

8.1.43 Append Table

To append rows to a new table:

- Select the rows you wish to copy to a new table.
- Right click on the table and choose **Copy/Append Selected Rows to table**.

Or you can use the Tools menu option here.

8.1.44 Mark and Select Rows

A row in a table can be marked and grouped by a label which enables the row(s) to be selected easily at a later time.

To mark a row

- Right click on the row in the table you wish to **mark**.
- Select **Mark Row/** and then choose a number. In the GUI the number of rows that can be marked is limited to 5 but this can be increased using the command line command.
- A row that is marked will be colored - each number is assigned a color. The coloring can be changed in the gui tab in preferences.

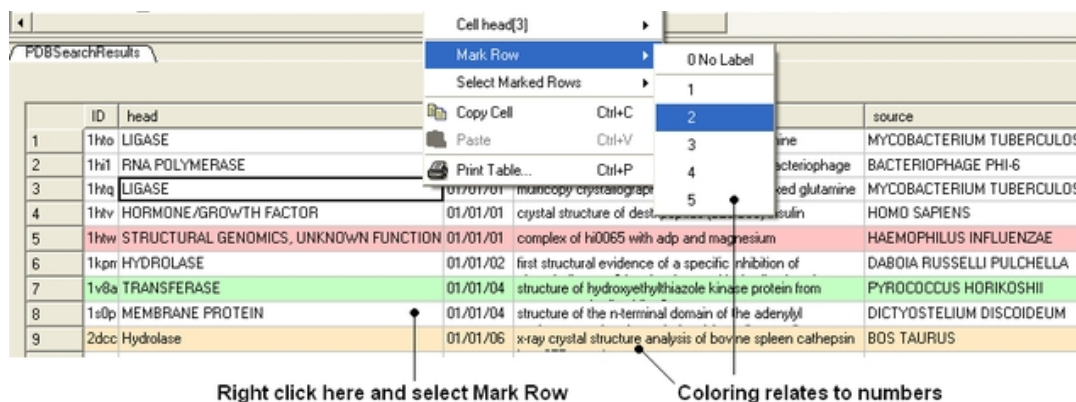

To select marked rows

- Right click on the table and choose **Select Marked Rows** and choose a number which relates to the marked rows as described earlier.
- Selected rows will be highlighted blue - once rows are selected a number of right click options are activated such as copy selection to new ICM table.

8.1.45 Group View by Column

To group a column by value:

- Right click on the column header and choose "Group View by Column". Chemicals in the same group are grouped in the same row. You can expand the view by clicking on the "+" sign".

Group by column.

1. Right click and choose "Group view by column".

2. Each group can be expanded here to see all members of the group.

mol	Molecule Name	class
+ 48 (1 of 2)	Histamine	
+ 50 (1 of 3)	Lamotrigine	32
	Pyrazinamide	33

To remove grouping:

- Right click on the column header and choose "Undo the Group View"

8.1.46 Mouse and Cursor Actions on a Table

The actions resulting from a mouse click or cursor on a table can be changed by:

- Right click on a table and select Table View/Show Extra Panel
- A panel as shown below will be displayed.

PDB Search results for 'kinase'

source	
thiazole kinase protein from	PYROCOCCUS H...
rosine kinase domain of the	HOMO SAPIENS
bacterium tuberculosis thymidylate	MYCOBACTERIU...
ndp kinase	DICTYOSTELIUM
eta	HOMO SAPIENS
ase, mutation r65q	SACCHAROMYCI
ine monophosphate kinase (thil)	AQUIFEX AEOLIC

Name	Value
tableTitle	PDB Search results for '<tb>kinase'</...>
doubleClick	nice "%1" no no no no delete a_MinObj
cursor	cursorFindPDB %# "%@"
separateTab	yes

Right click here and select Table View to display and undisplay extra panel

Double click here to edit actions

- Double click in the **Value** column and the column can be edited. Add ICM commands for the action you want. A value in a column can be referred to using "%" e.g. column two would be referred to as "%2". In the example shown above the function nice is acting on the contents of column one for the double click action.

NOTE: The action associated with cursor and double click is placed in a variable name TableName.cursor and TableName.doubleClick

8.2 Molecular Tables

Available in the following product(s): ICM-Chemist | ICM-Chemist-Pro | ICM-VLS

An ICM molecular table is created when an SDF or Mol file is read into ICM. To read and open a mol or sdf file go to File/Open (See Open an ICM file section) All of the table functions described in the previous section Standard ICM Table can be applied to molecular tables. Molecular tables are described in more detail in the Cheminformatics chapter.

An example of an ICM molecular table:

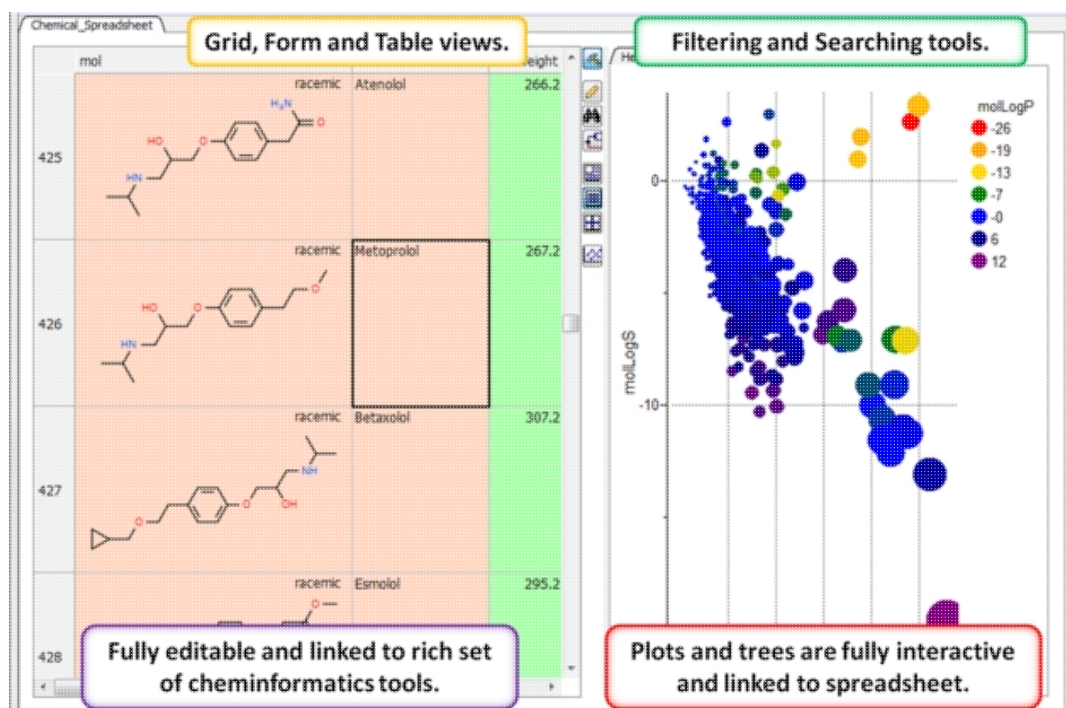

8.3 Insert Interactive Objects into Table Cell

Available in the following product(s): ICM-Chemist | ICM-Chemist-Pro | ICM-VLS

NOTE: This option is available in Version 3.7-2b and above.

To store objects in a table please use the following:

Example:

```
read pdb "1crn"  
display a_  
add column t Parray( object a_ preview )
```

Viewing Objects from the table can be dragged and dropped into the ICM Workspace to display them again.

How to make the objects in the table fully interactive

- Right click on the column header and select "Live Rotatable View"

8.4 Plotting Table Data

Available in the following product(s): ICM-Chemist | ICM-Chemist-Pro
| ICM-VLS

The data within a table can be plotted graphically. A histogram can be made for the data within one column or a plot can be constructed for the data within two columns.

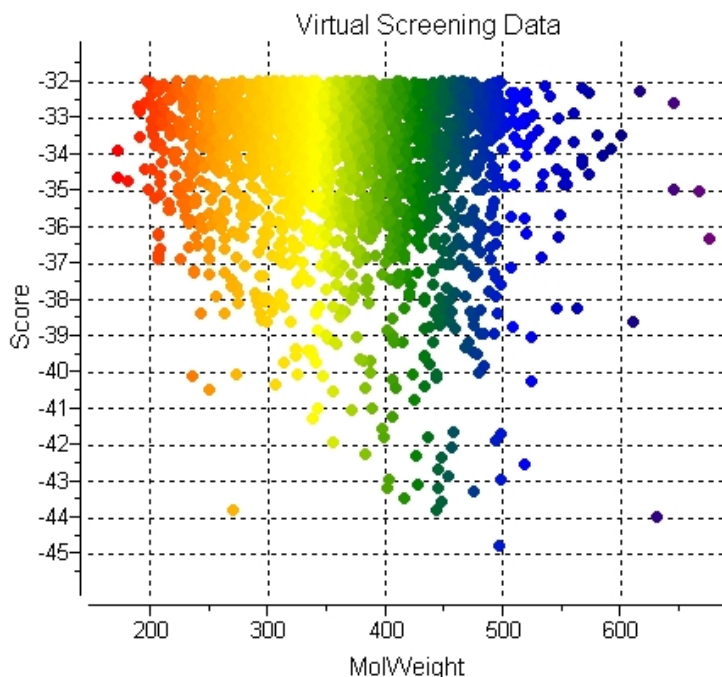

To make a plot, histogram or heatmap:

- Read in a chemical spreadsheet or other data in spreadsheet form (e.g. csv).
- Click on the plot button at the side of the table (shown below).

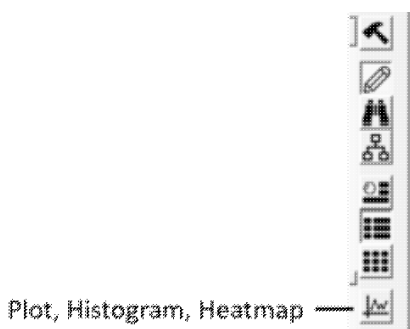

8.4.1 Column Histogram

To plot a histogram of the data within one column:

- Select the column by clicking on the column header.
- Right click on the column header.
- Select the **Column histogram** option.

Click here to select the column and then right click and select column histogram option

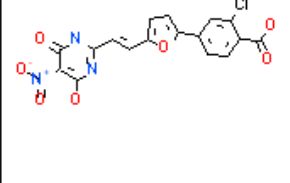
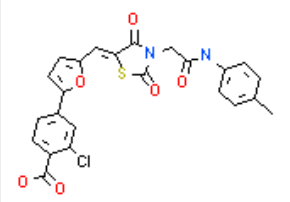
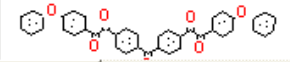
dock_example			
	mol	MoWeight	Score
1		403.738	-46.19
2		496.930	-44.81
3		630.660	-44

A plot will then be displayed next to the table.

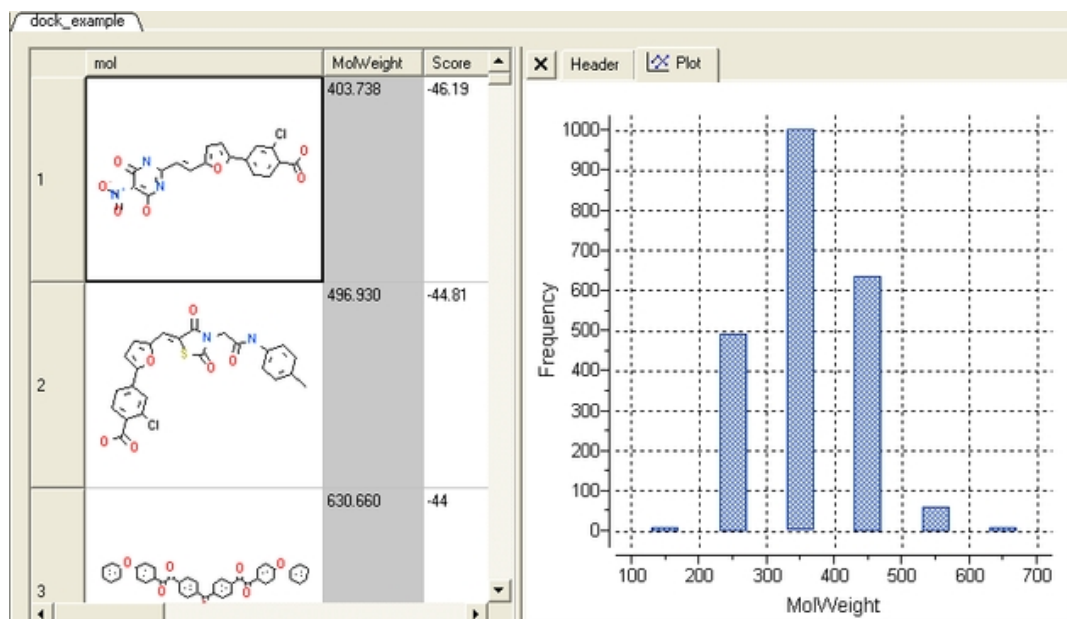

8.4.2 Histogram Options

Once you have created a histogram you can change the following parameters by right clicking on the plot and selecting options

Options:

- Change plot title.
- Change the data source using the drop down button and select another column in the table.
- Change the histogram bin size.
- Change the bars positioning from vertical to horizontal.
- Change the bar relative width compared to bin size. Bigger values give thicker bars.
- Color the bars

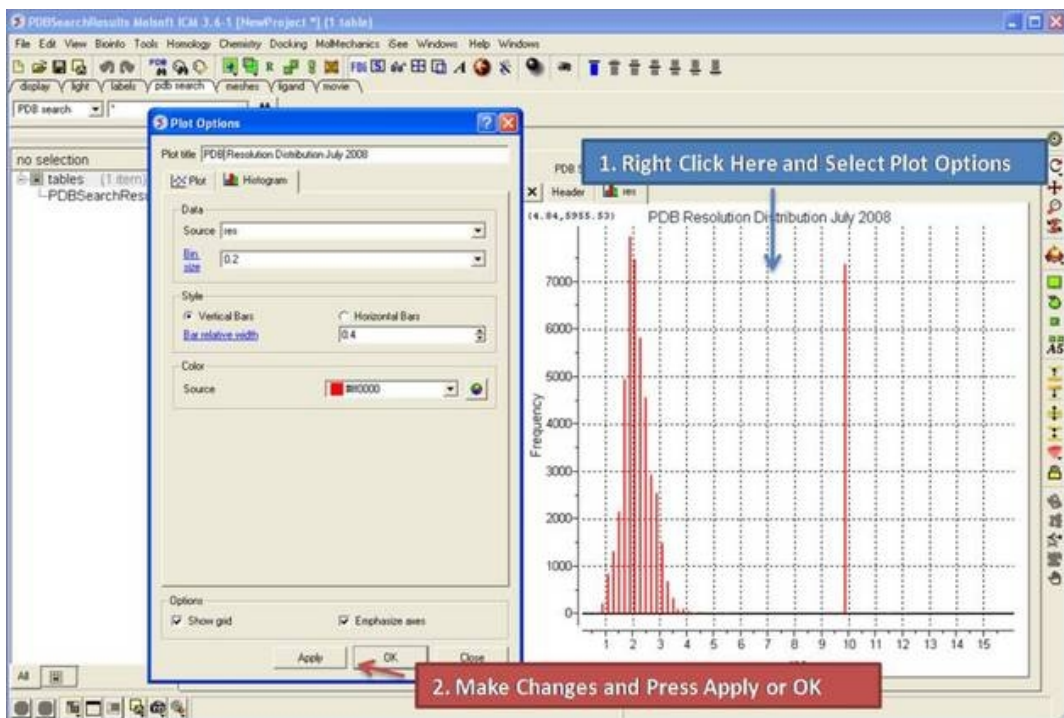

8.4.3 Histogram Bins

There are two ways to change the bin size. 1. Using the options dialog box or 2. interactively by left clicking and dragging at the top of the plot as shown below - this will allow you to find the best density estimation picture.



8.4.4 Plots

To construct a scatter plot from data within two columns:

- Click on the plot options button (right hand side of table).

- Select the data from the drop down options in the Data section of the dialog box. There are additional options to change the color, mark shape or size, and grid and axis display.

The image shows a software interface with a data table and a 'Plot Options' dialog box. The data table contains chemical structures and numerical values. The dialog box is titled 'Plot Options' and has several sections:

- Data:** X: molWeight, Y: molLogP. Both have checkboxes for 'Logarithmic'. There are also options for 'Swap X and Y', 'Series', 'Balloon', and 'Filter'.
- Marks:** Size: 6, Shape: (dropdown), Point labels: (dropdown), Plotting style: dots. There is a checkbox for 'Show labels for selection only'.
- Color:** Source: <fixed>, Gradient: red/orange/gold/green/blue/darkblue/purple. There is a checkbox for 'Intensity'.
- Confidence Intervals:** X conf.: <none>, Y conf.: <none>.
- Least squares fitting line:** Linear, Logarithmic, X=Y.
- Options:** Show grid (checked), Emphasize axes, Antialias.

Two callout boxes provide instructions: a yellow box labeled '2. Select data here' points to the 'Data' section, and a red box labeled '1. Open plot options dialog window.' points to the 'Plot' button in the top left of the dialog.

8.4.5 Multiple Curves

Multiple curves can be added to a plot:

- Make a plot of the first curve.
- Right click on the plot and choose **Options**.
- Select the "+" button next to Curve data entry box.
- Enter new X and Y data for the second Curve.
- Shading as shown in the image below (red shading) can be achieved by selecting Plotting Style > Vertical bars.

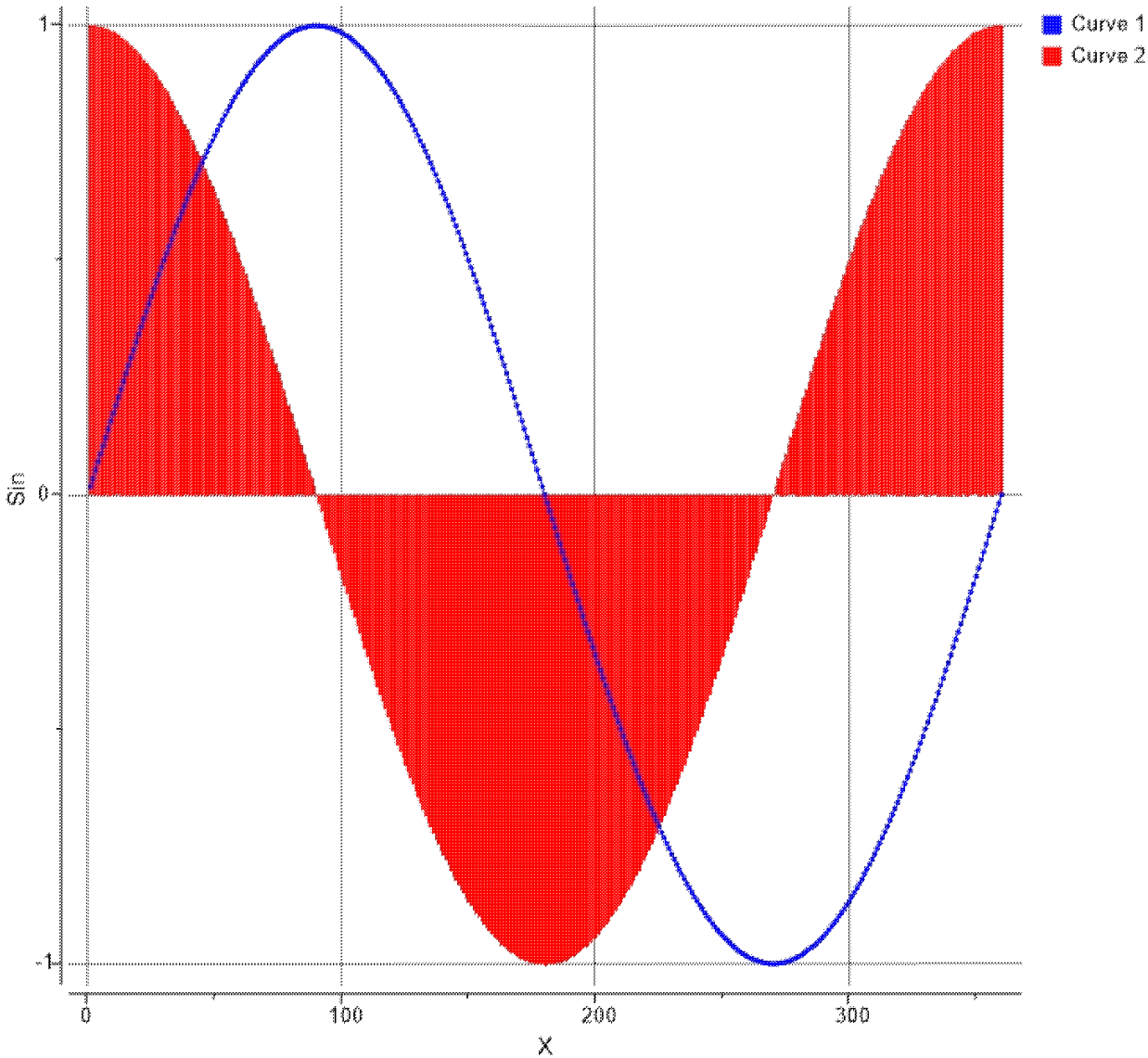

8.4.6 Heatmap

To generate a heatmap:

- Read in a table containing the data.
- Click on the Plot/Histogram button on the side of the table.
- Click on the heatmap tab at the top.
- Add the data sources you want in the heatmap based on the column headers in the table.
- Check how you want to label the rows.
- Edit the color gradient if necessary.
- Click OK.

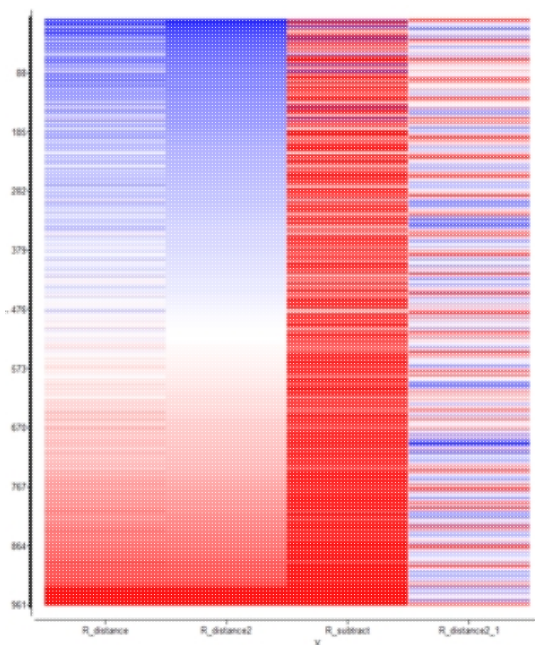

8.4.6.1 Heatmap Example

This example shows how you can place a fully interactive heatmap next to a tree.

- Read in table d.tsv from here:
<ftp://ftp.molsoft.com/pub/workshop/> (1. cut and paste the address into a web browser. 2. Right click on d.tsv and choose "Save Link As". 3. Open the .icb in ICM File/Open).
- Select numerical columns by clicking on the column header and holding CTRL key.
- Right click on the column header and choose "Reorder by Clustering".
- Click on the `cluster` button on the right hand side of the table and use the default options.
- Right click in the cluster and "Change Record Labels"
- Check color check box and click 'Add All Numerical'
- Remove cluster related columns from the end ('cl' 'ord', etc ...)
- Click OK a tree and heatmap as shown below will be displayed.
- CTRL +/- allows you to zoom in and out.

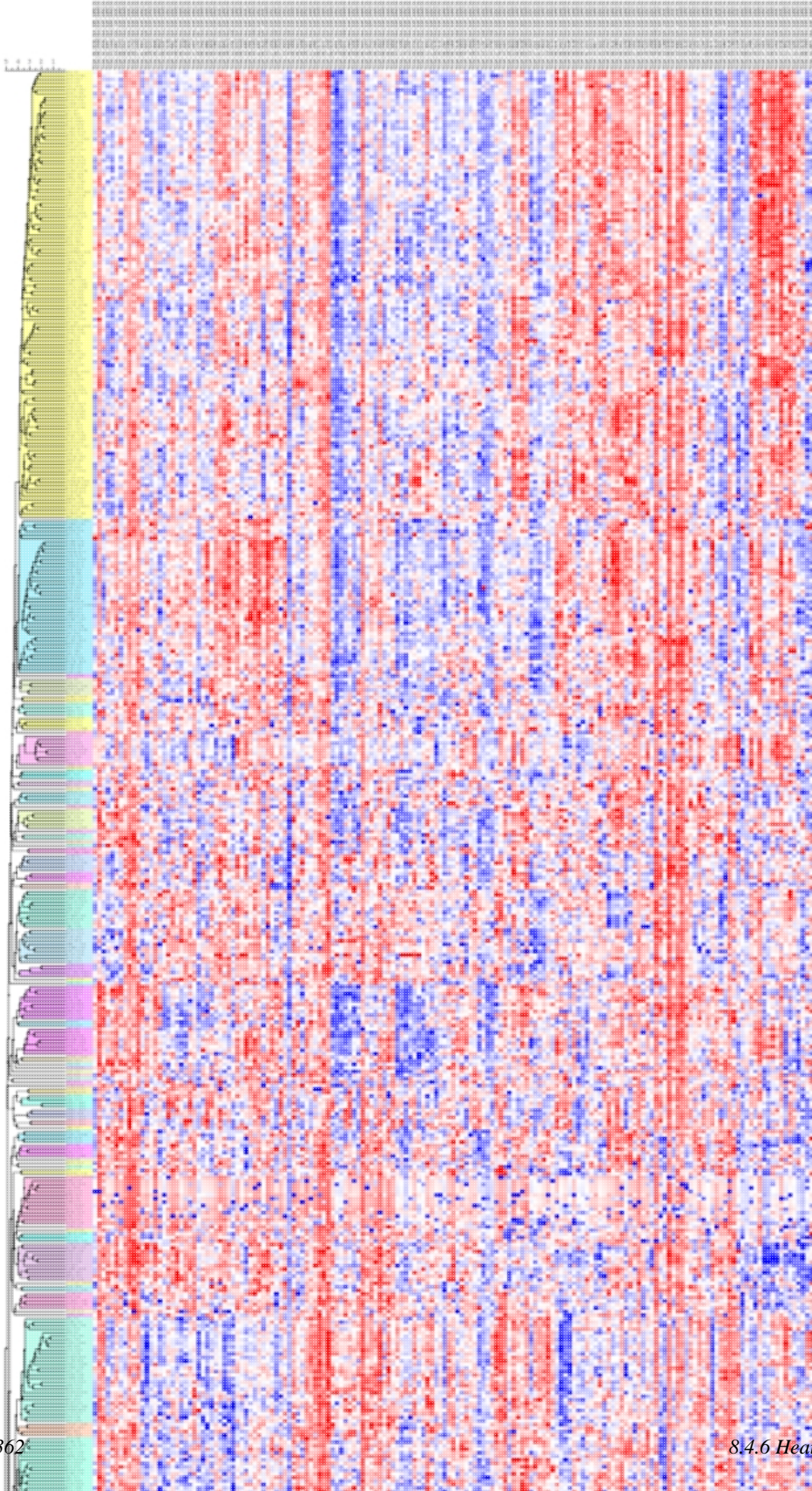

8.4.7 Pie Chart

To generate a Pie Chart:

- Read in a table containing the data.
- Click on the Plot/Histogram button on the side of the table or right click choose **Options** on a plot.
- For **Histogram** choose **Plotting Style > Pie radio bin**. Number of bins/sectors can be controlled through the 'Bin Size' parameter. For **Plots** choose **Points > Plotting Style > Pie 'X'** should be discrete (integer or string column with categories), 'Y' - any numerical column.

Most Common Cause of Cancer Death

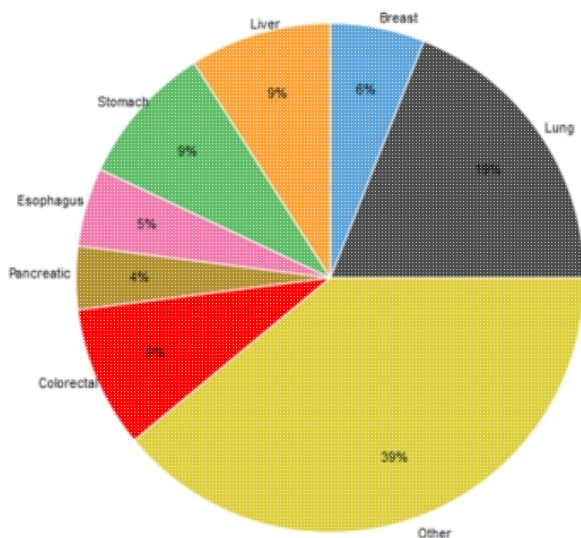

X-Y Plots:



Histograms:

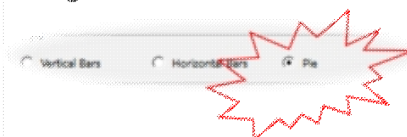

8.4.8 Add a title to a plot

To add a title to a plot:

- Right click on the plot and select **Edit Title** or choose **Options**

8.4.9 Axis Options

Each axis has a set of options which can be accessed by right clicking on the axis and selecting **Options**.

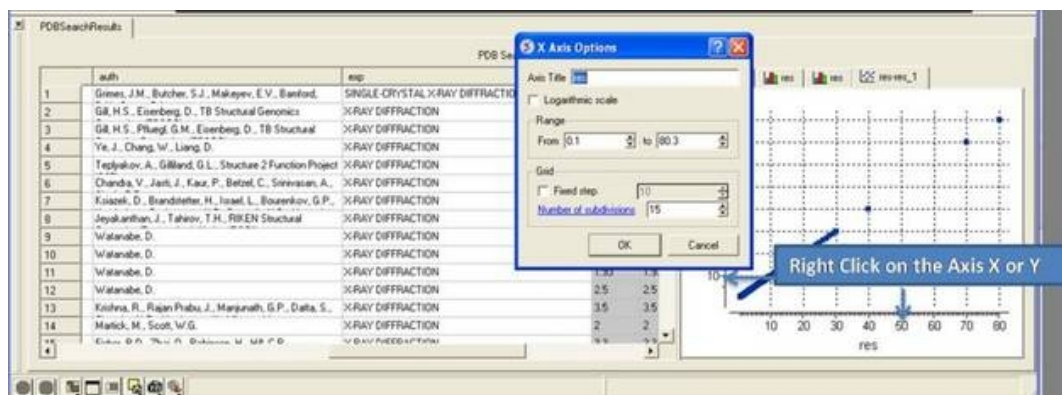

To change the title of the X or Y Axis:

- Right click on the axis and select **options**

To change the data range:

- Right click on the axis and select **options**
- Change the **From** and **to** values in the **Range** box

To change the Grid steps (ticks) on the X or Y axis:

- Select either a fixed step e.g. 10 and you can define the number of subdivisions (ticks) in each step. Choosing 1 will display zero ticks between divisions.

To change the axis to logarithmic

- Right click on the axis and select **options**
- Select the Logarithmic scale check box

8.4.10 Change Axis Data

To swap the X and Y axis:

- Right click on the plot and select **Options**.
- Select the **Swap X and Y** button.
- Click OK.

To change the data source for either the X or Y axis:

- Right click on the plot and select **Options**.
- Select the drop down arrow as shown below and select a different column from the table.
- Click OK.

8.4.11 Logarithmic Plots

To change the scale of the axis to logarithmic:

- Right click on the plot and select **Options**.
- Select the **Logarithmic** check box.

8.4.12 Change Mark Shape or Size

To change the plot mark, shape, style or label:

- Right click on the plot and select **Options**.
- Select the desired size and shape using the drop-down buttons in the **Marks** section of the window.

To add point labels:

- Right click on the plot and select **Options**.
- Select the drop down arrow in the **Point labels** dialog box
- If you only want to label selected points check the **Show labels for selection only** option. Making plot selections is described [here](#).

8.4.13 Change Mark Color

To change the color of the plot marks:

- Right click on the plot and select **Options**.

- In the **Color** section of the window select the **Source** (column name plotted as X or Y) you wish to color.
- Select the color palette and choose the desired color or you can choose a Gradient of colors.

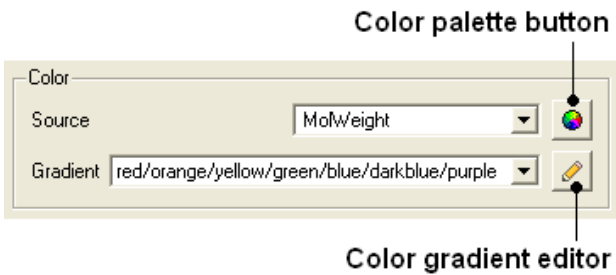

To edit the color gradient

- Click on the **Color gradient editor** button and a window as shown below will be displayed.
- Click and drag on a mark in the gradient plot to change the color gradient.
- Right click on a color in the Y-axis to - **Edit, Duplicate or Remove Color**.
- The color gradient can be applied to all points in the data or for a fixed range.

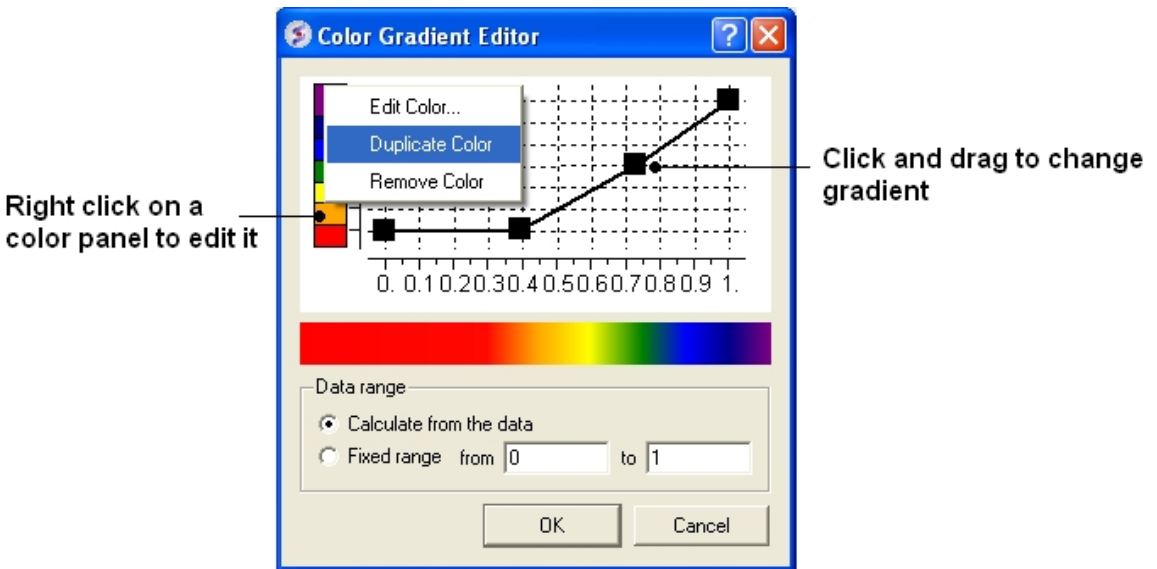

8.4.14 Grid and Axis Display

To remove the grid display and/or highlight the axes:

- Right click on the plot and select **Options**.
- Check the **Show grid** or **Emphasize axes** options.

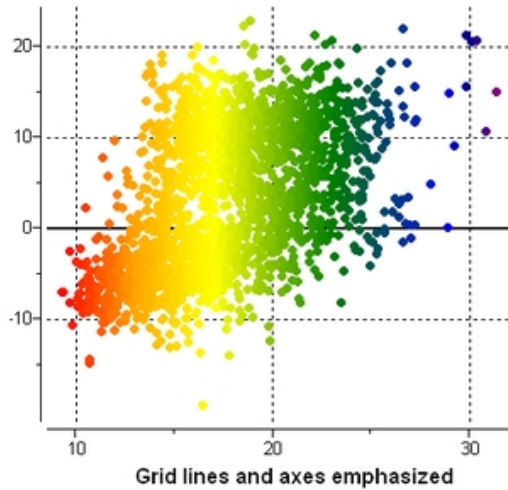
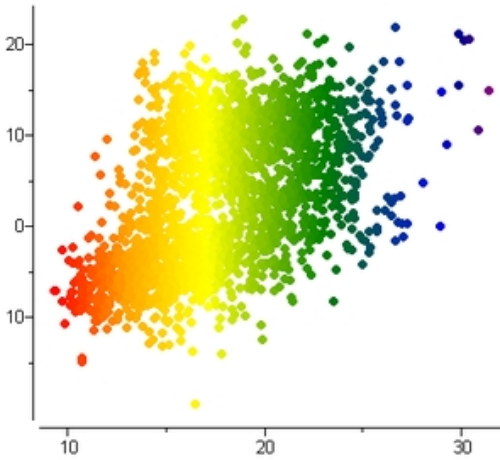

8.4.15 Least Squares Fitting

To fit the data to a straight line using least square fitting and report the equation:

- Right click on the plot and select **Options**.
- Select the check box for **Least squares fitting line**.
- Choose Linear, Logarithmic or X=Y.

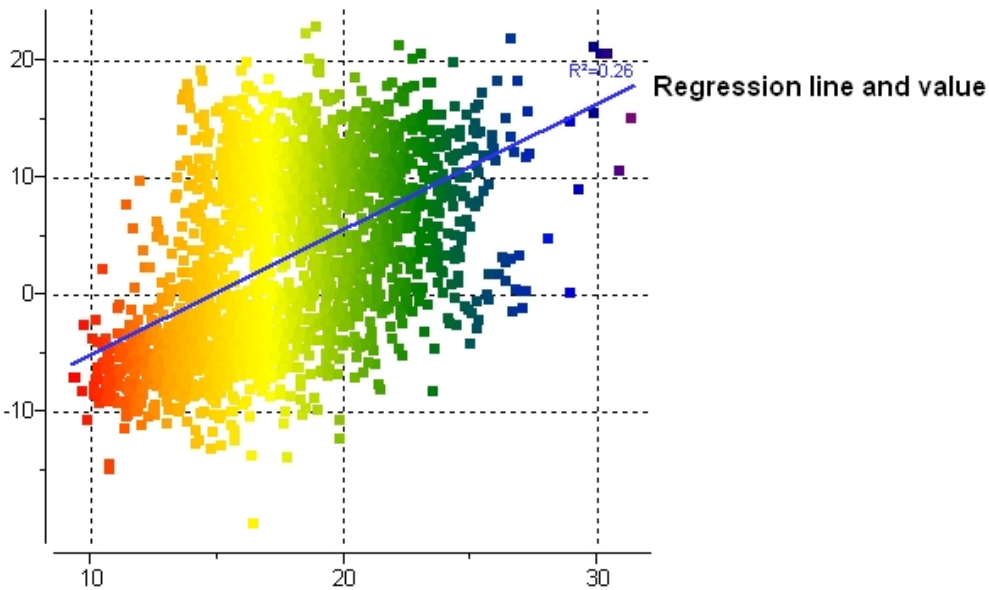

8.4.16 Zoom, Translate and Center

To zoom into a plot:

- Click outside the plot on the left-hand-side and drag the mouse or use the middle mouse wheel to zoom in and out.

To translate a plot

- Click, hold and drag using the middle mouse button on the plot.

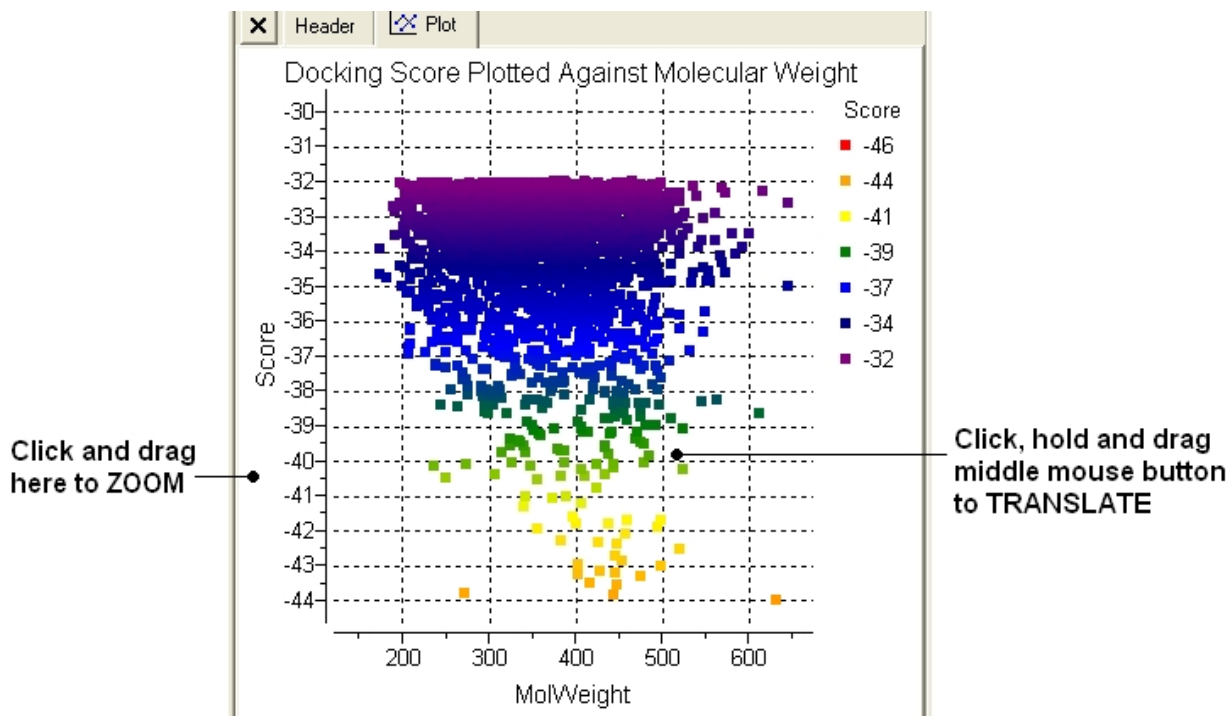

To center onto a plot

- Right click on the plot and select **Center all** or **Center Selection**. Making selections in a plot is described in the next section.

To center into an axis

- Right click on the axis and select **center**.

To zoom into an axis

- Hover the mouse over the axis until you see a blue rectangle surrounding the axis.
- Use the middle mouse wheel to zoom in and out as shown below.

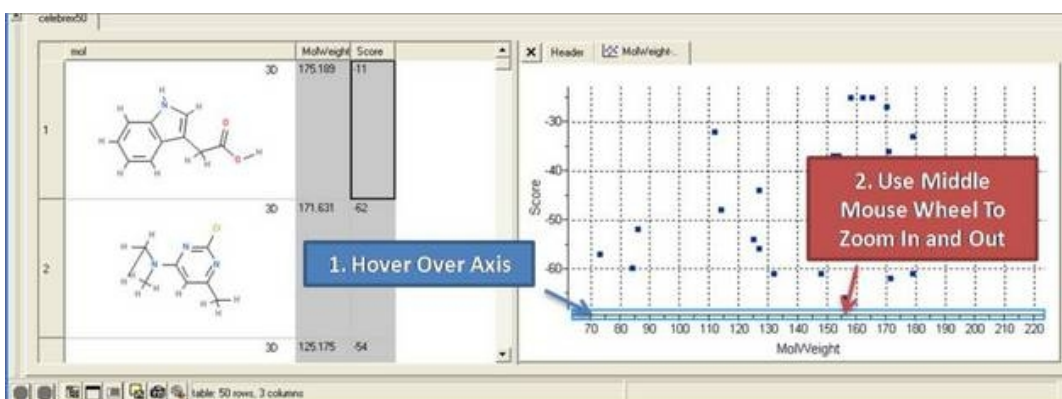

8.4.17 Plot Selection

To make a selection in a plot:

- Click and drag in the plot to make a selection. Individual points can be selected with a single click.

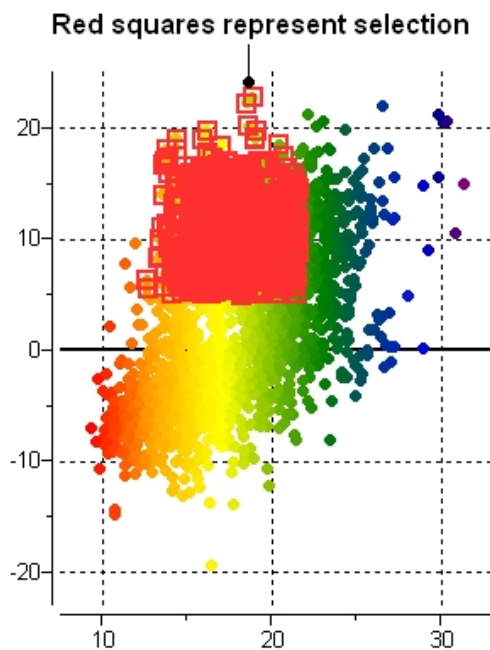
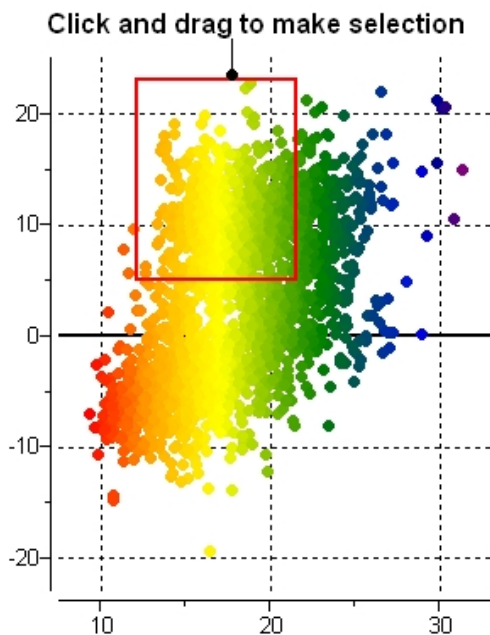

All selections are directly linked to the table from which the plot was made. Selections in the table are highlighted in blue.

2088		47	0	-36.91	0
------	--	----	---	--------	---

Selection highlighted in blue in a table

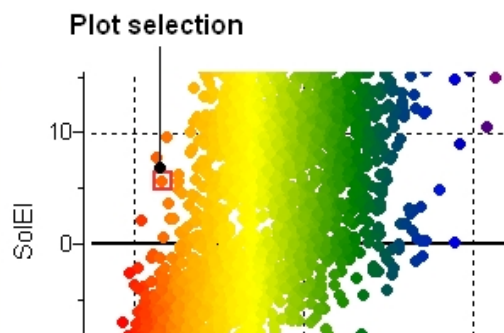

Non-contiguous selections in the plot can be made by holding the CTRL key.

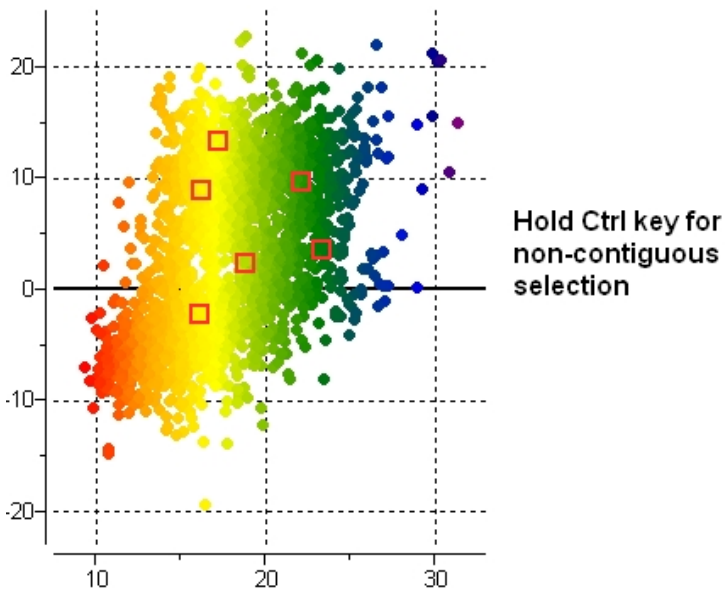

8.4.18 Point Label

To add a label to one or more points:

- Right click on the plot and choose **options**.
- Look for the section **Points** and the dialog box `*{Points Labels}`
- For this example we will use the drop down button and choose "mol".
- Check the option show label for selection only.

To drag the label:

- Left click on the label and drag.

To make the label display bigger

- **Hold the Ctrl key** and use the middle mouse button.

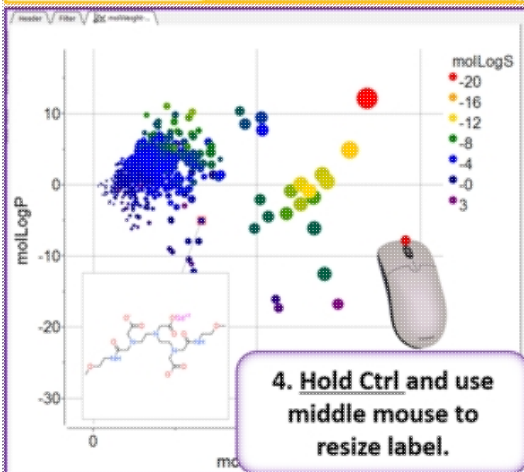
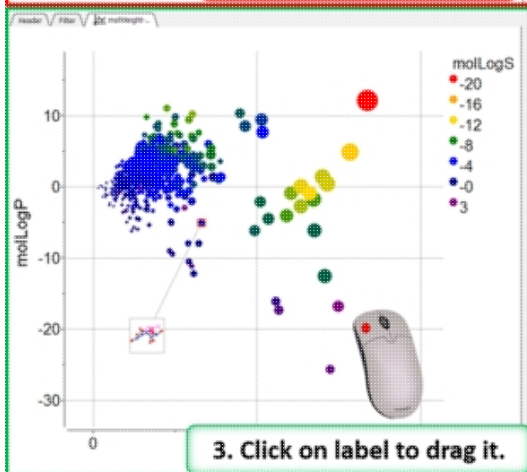
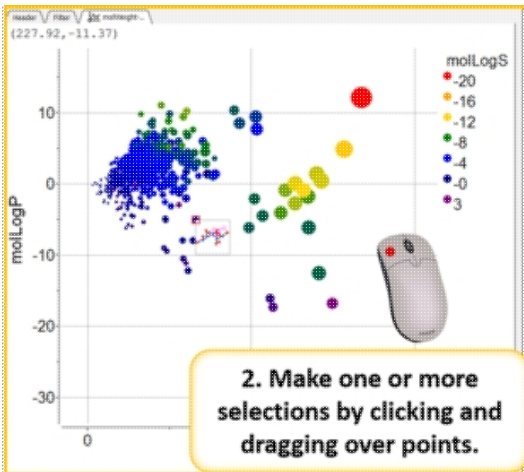

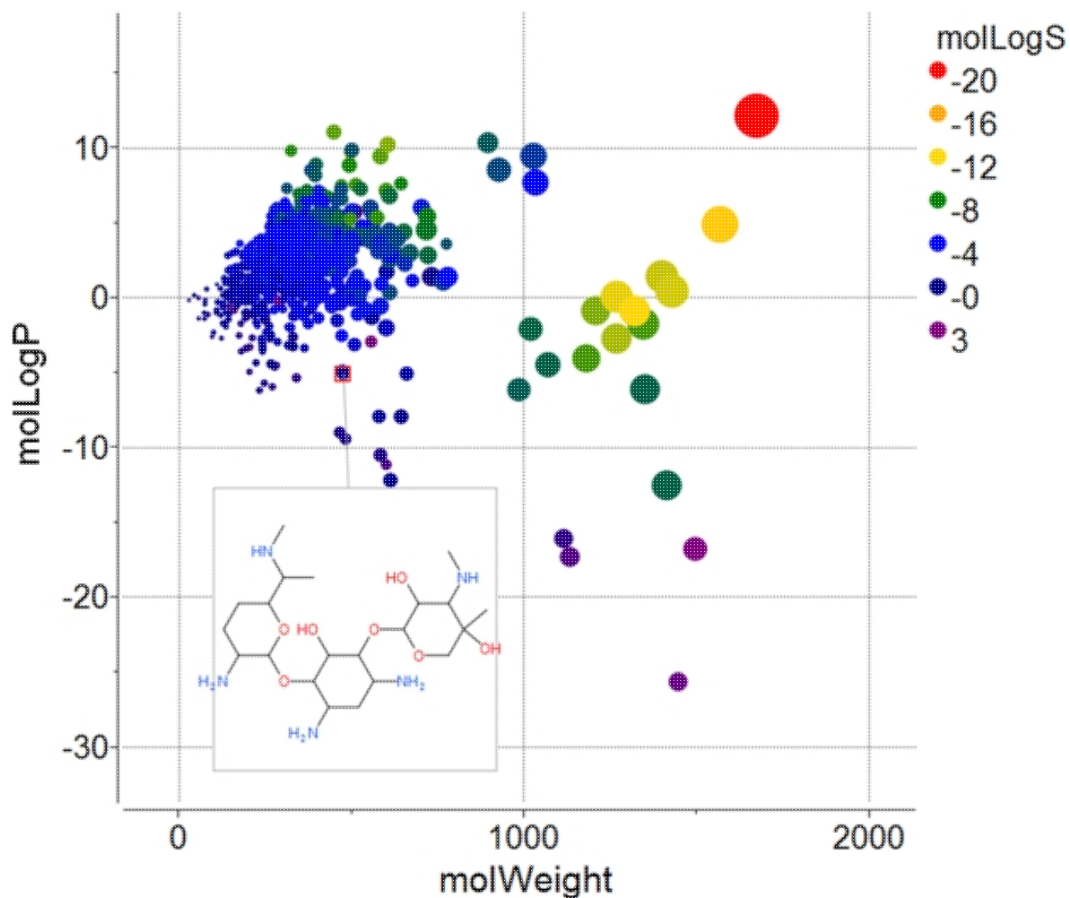

8.4.19 Print Plot

To print a plot:

- Right click on the plot and a menu will be displayed.
- Select the print option.

8.4.20 Saving a Plot Image

To save a plot image or copy to clipboard:

- Right click on the plot and select Options and then check the antialias button. Click Apply and OK.
- Right click on the plot and a menu will be displayed.
- Select the **Save/Export Image** option.

8.4.21 Table Inline Plots

Plots can be inserted into a table row by:

- Select the columns you wish to plot.
- Right click on the column header and select **Inline Plots**
- The plot will then be displayed in each row of the table.

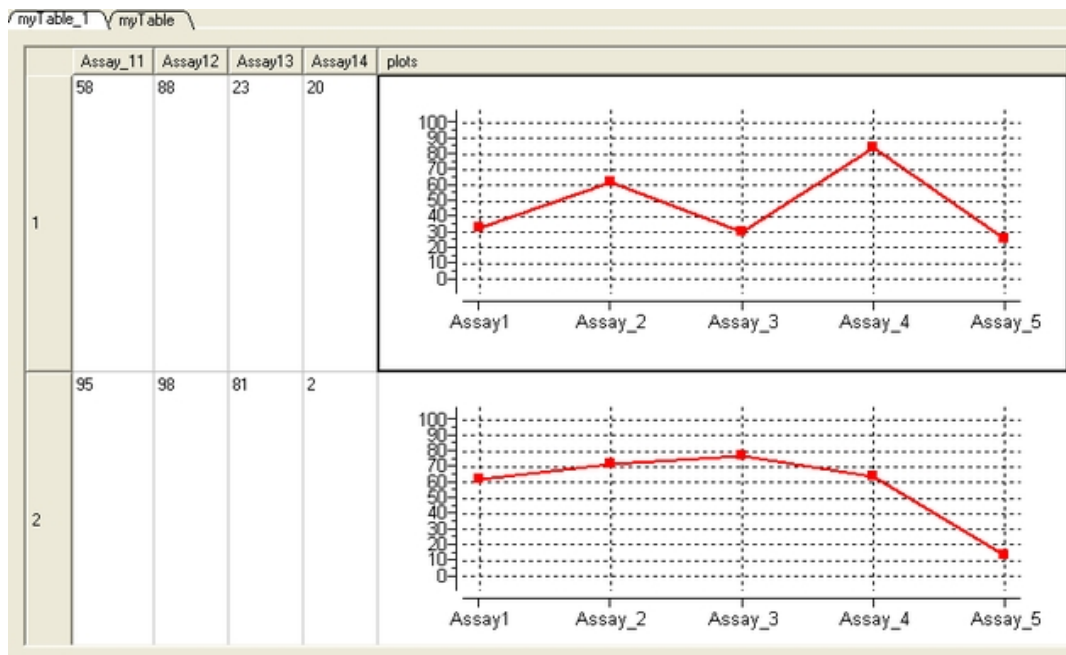

8.4.22 Annotate Plot

You can add text, lines, rectangles, and ellipse to a plot. To annotate a plot:

- Right click on a plot and select Annotate.
- Select the draw element and then click on the plot.
- Change the draw element properties if needed (e.g. font size).

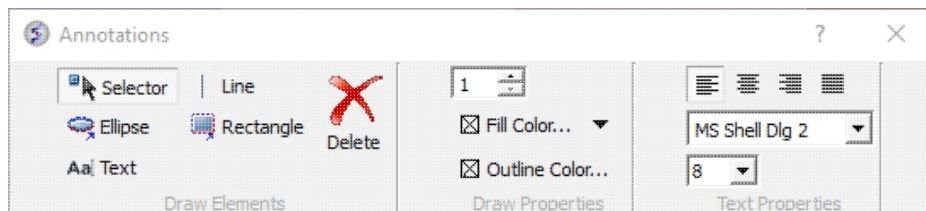

8.4.23 Plot R-Groups

To plot R-groups e.g. from the results table of library decomposition.

- Click on the plot button on the side of the chemical spreadsheet.
- Select the R-group column for the X and Y axis.

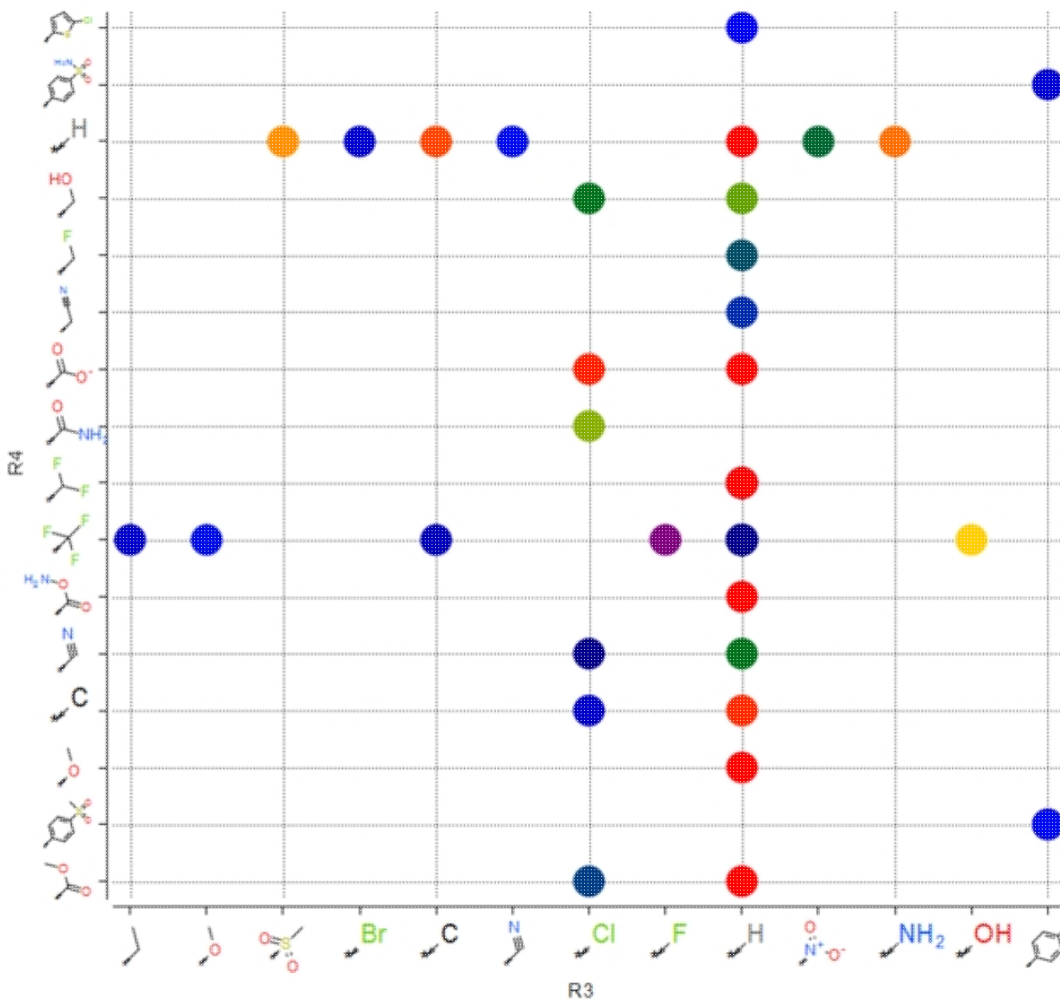

8.4.24 Tooltips Balloons

When you hover over a point in a plot it is sometimes useful to be able to visualize some data regarding that plot. You can do this by setting a balloon.

- Right click on the plot and select Options.
- Enter the name of the columns containing the data you wish to display in the balloon (e.g. mol, ID).
- Hover over a point in the plot and the balloon will be displayed.

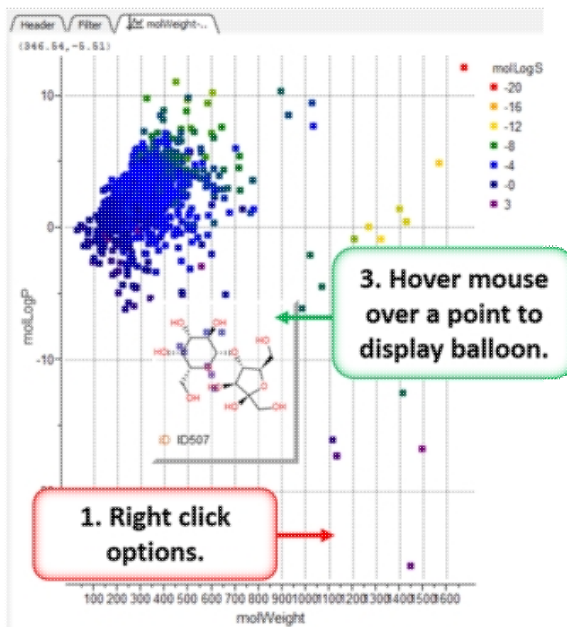
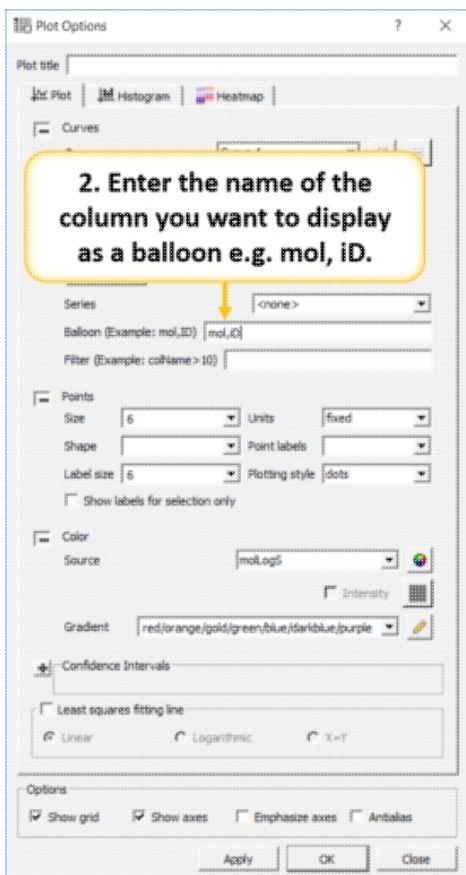

8.5 Principal Component Analysis

Available in the following product(s): ICM-Chemist | ICM-Chemist-Pro | ICM-VLS

Principal Component Analysis (PCA) is the younger brother of ICM's more powerful data analysis tools, like property prediction and clustering, though it still may give a good description of the data with a few columns or even chemical compounds. PCA is a mathematical procedure that transforms a number of correlated variables into a number of smaller uncorrelated variables known as Principal Components. The first component accounts for as much of the variability as possible with the rest of the components accounting for the remainder. PCA may be very helpful when you believe the data actually contains only a few meaningful components. Principal components are linear combinations of the provided data columns.

To perform a PCA analysis a table (either chemical or standard ICM table) needs to be loaded into ICM. For information regarding ICM Tables and ICM Chemical Tables please follow these links.

To begin the PCA procedure

- Right click on an ICM Table and ICM Chemical Table and select the PCA option. It is important to right click inside the data table and not on a column or row header in order to see the correct menu on which pca is listed.
- Select which columns you wish to incorporate into the PCA analysis.

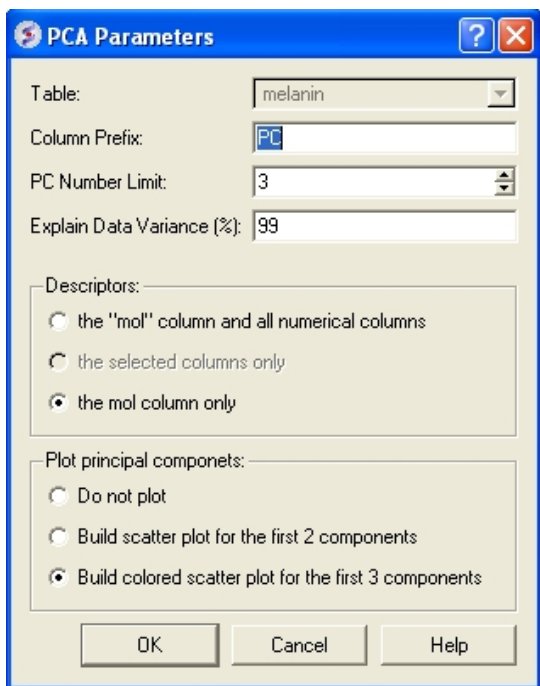

- Enter the table name on which you wish to perform the PCA analysis. If only one table is loaded this option will be greyed out.
- Enter the number of Principal Components (PC number limit) you wish to generate. Generally 3 principal components may be effectively visualized and it will be enough often to fulfil the data variance percentage requirement (see next option). The value displayed in the terminal window under the heading "cumulative explained data variance" will show what percentage of data relates to each PC.
- Enter a value in the "Explain Data Variance (%)" data entry box (99% is the default value) if you prefer this indirect way of limiting number of PC. The algorithm will stop when either PC number or explained variance limit is reached, so if you want only one of this criteria to work, make sure that the other limit is weak (by assigning accordingly the number of PC limit a high value, e.g. 50, or setting data variance to 100%).
- Select which descriptors you would like to include in the PCA analysis.
- Select which plot you would like to display. If you choose to display a plot use the color key on the side of the plot and the information contained within the ICM terminal window to relate which axes and points relates to which PC. PC3 is usually the color in the plot with the values displayed in the plot key.
- Click OK and if selected a plot will be displayed on the right-hand-side of the table. Points within a plot are linked to the table and can be manipulated as other plots contained within a table.

8.6 Learn and Predict

Available in the following product(s): ICM-Chemist-Pro | ICM-VLS

Please click [here](#) to go to the Learn and Predict chapter.

8.7 Data Clustering

ICM allows you to create hierarchical clusters for chemical and other objects. Cluster trees can be used for:

- Navigation through large data sets.
- Selecting group representatives (taxons).
- Filtering tables to exclude redundancy.
- Finding similar elements, and more.
- Creating hierarchical views of data sets in many different styles, with subsequent image export/printing ability.

8.7.1 Cluster

Available in the following product(s): ICM-Chemist | ICM-Chemist-Pro | ICM-VLS

To perform clustering based on chemical similarity or any other data you must have an SDF file or table loaded into ICM.

- Right click on the table and select the Clustering option OR select the Chemistry menu and choose the option entitled **Cluster Set**.

OR

- Tools/Table/Clustering.

A data entry box as shown below will be displayed.

Clustering Parameters

Table: Xdict

Name:

Take Labels from Column: NAME_

Keep the existing trees

Add column with cluster numbers, name: d

Build for the selected 0 rows (at least 2 required)

Descriptors:

the "mol" column and all numerical columns the mol column only (2D pharmacophore) dimt_UPGMA

the selected columns only the seq column only

the "mol" column only (fingerprints) use existing distance matrix:

Method:

Tree Memory required: 1 MB

Parameters:

Linkage type: UPGMA

Keep distance matrix

Compressed hierarchical clustering

OK Cancel Help

- Select the table you want to cluster from the drop down menu.
- Give the tree a name.

- Select the column you would like to use to label the tree (this can be changed or appended to once the tree has been made - right click on tree and choose "Change Record Labels").
- You can choose to keep the existing tree.
- The cluster number names will be added to your table - you can change the label of the columns (default = cl).

Now select the descriptors you wish to use for clustering.

- The "mol" column and all numerical columns.
- The "mol" column only (2D pharmacophore)
- The selected columns only.
- The sequence column only.
- The "mol" column only (fingerprints).
- Use existing distance matrix. UPGMA is a linkage method which is used to group tree nodes together. (they are described in the link below). `dimt_UPGMA` is used when 'use exiting matrix' mode is selected. It can be any exiting matrix. This usually comes from previous clustering if 'Keep distance matrix' option was selected

Select the method you wish to use for clustering.

- **UPGMA** (unweighted pair group method using averages): Distance calculated is the average of all elements (recommended).
<https://en.wikipedia.org/wiki/UPGMA>
- **Single** linkage: Nearest neighbour linkage -
https://en.wikipedia.org/wiki/Single-linkage_clustering
- **Complete** linkage: Furthest neighbour linkage -
https://en.wikipedia.org/wiki/Complete-linkage_clustering
- **WPGMA**: (weighted pair group method using averages): Rough approximation of weighted (slightly faster)
- **Farthest**
https://en.wikipedia.org/wiki/Complete-linkage_clustering
- **Ward**: https://en.wikipedia.org/wiki/Ward%27s_method
- **UPGMC**: Centroid linkage clustering
- **UPGMC-corr**: Correlation clustering provides a method for clustering a set of objects into the optimum number of clusters without specifying that number in advance.

NOTE If you wish to cluster a selection of a table; first select the compounds you wish to cluster (Ctrl A will select all or see the section of the manual entitled `making table selections`).

Check the option "Keep Distance Matrix" if you wish the Distance Matrix to be saved.

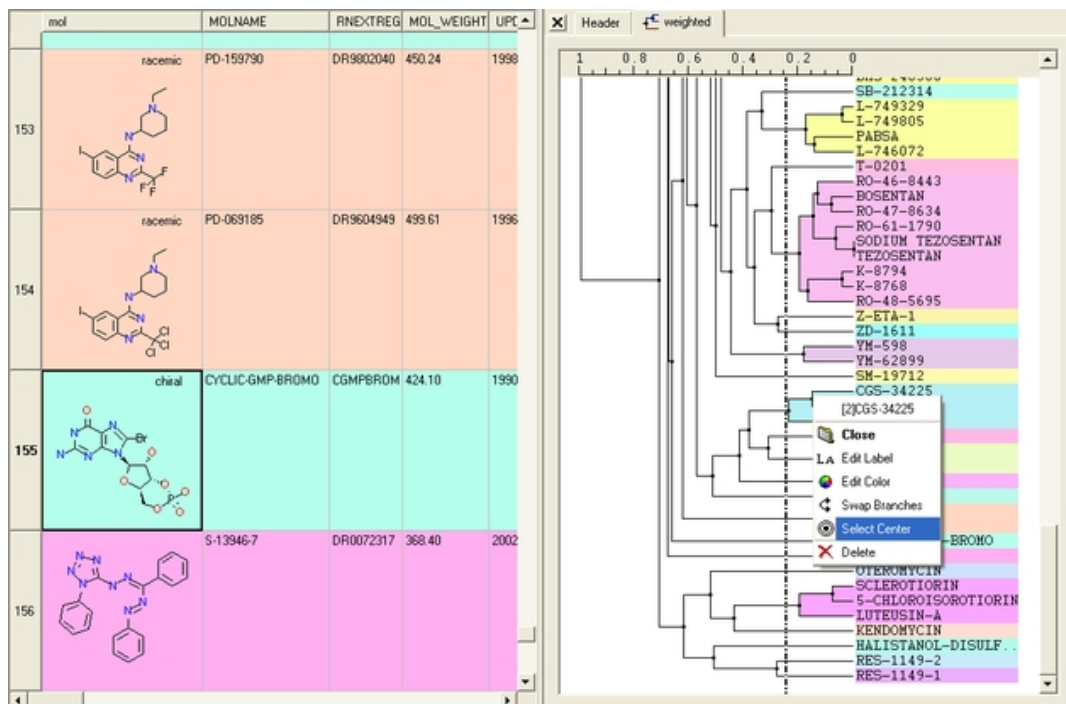

8.7.2 Tree Selection

A number of different selections can be made once the tree has been created.

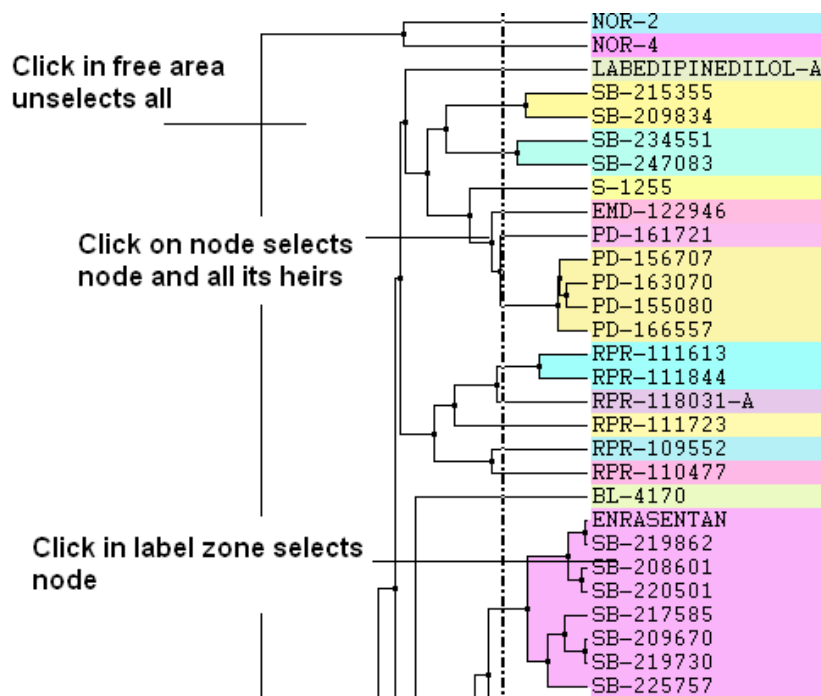

- Click in free area unselects all.
- Click on node selects node and all its heirs.
- Ctrl-click adds to (if not selected yet) or removes from (if already in selection) current selection.
- Shift plus click allows a range to be selected.
- Click in label zone selects node.

- Keyboard "Up"/"Down" cursor keys move selected node up/down in the tree. With Shift held the selection expands in the according direction.
- Keyboard "Escape" unselects all.

Select Center Representatives From a Node.

To select the "center" representative compound or value from a cluster.

- Right click in the free area of the tree and select the option "Select Centers".

NOTE: Selections in the tree will be highlighted in blue in the tree

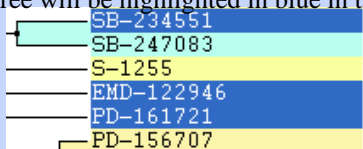

and in the table.

Copy selection to new table.

All selections can be copied to a new table by:

- Right clicking on the selected rows in table and a menu will be displayed.
- Selecting the "copy selection to ICM table" option.

8.7.3 Save and Print Tree

To save a tree

Option 1:

- Save the whole session as an ICM project. See Saving an ICM project

Option 2:

- Save the table as an .icb file. Right click on table header and select "save as".

To save a tree as a picture

- Right click in the "free area".
- Select "Save Image..."

The image of the tree can also be saved to the clipboard.

- Right click in the "free area".
- Select "Copy Image to Clipboard"

To print the tree

- Right click in the "free area".
- Select "Print"

8.7.4 Tree View

A number of changes to the tree view can be made by right clicking in the tree "free area" and selecting preferences as shown below.

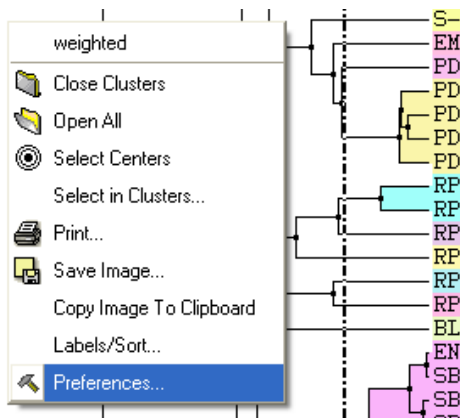

A preferences window as shown below will be displayed.

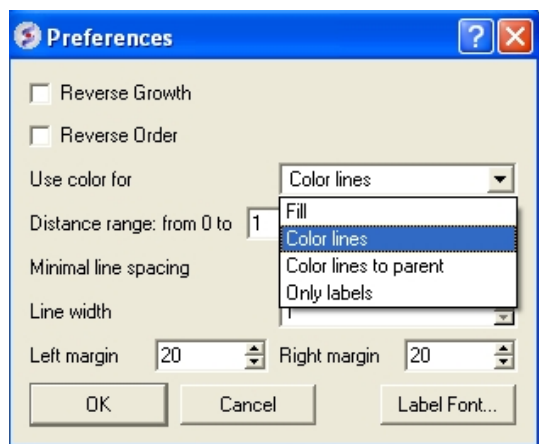

Reverse Growth:

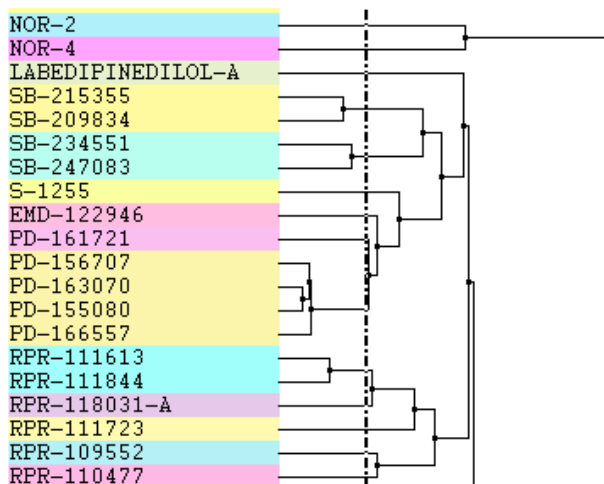

Distance Range:

Distance range changes scale here

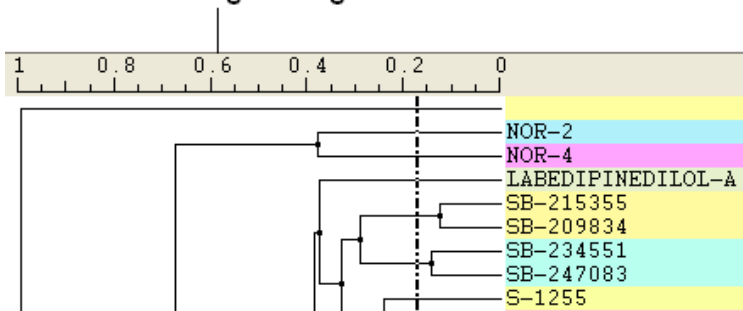

Color Preferences:

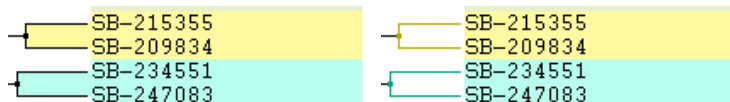

Left: Fill **Right:** Color Lines

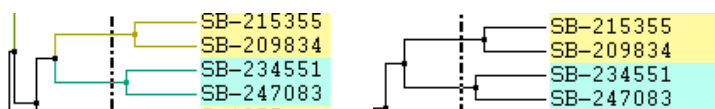

Left: Color lines to parent **Right:** Only labels

Increase or Decrease Line Spacing:

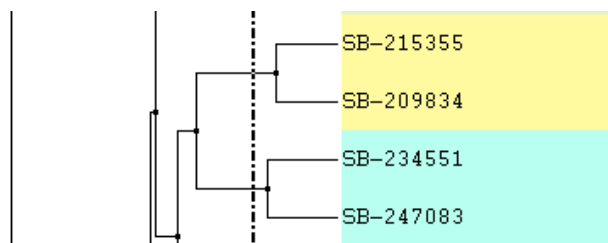

Increase or Decrease Line Width:

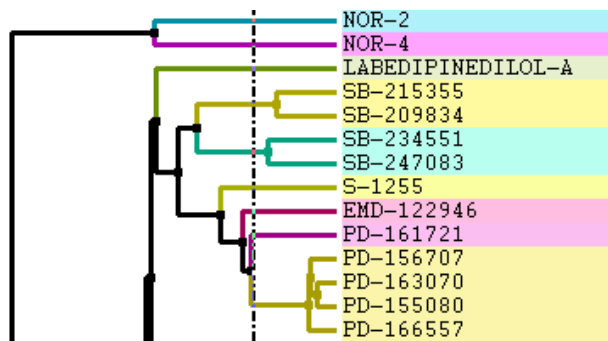

Change Font and Margins:

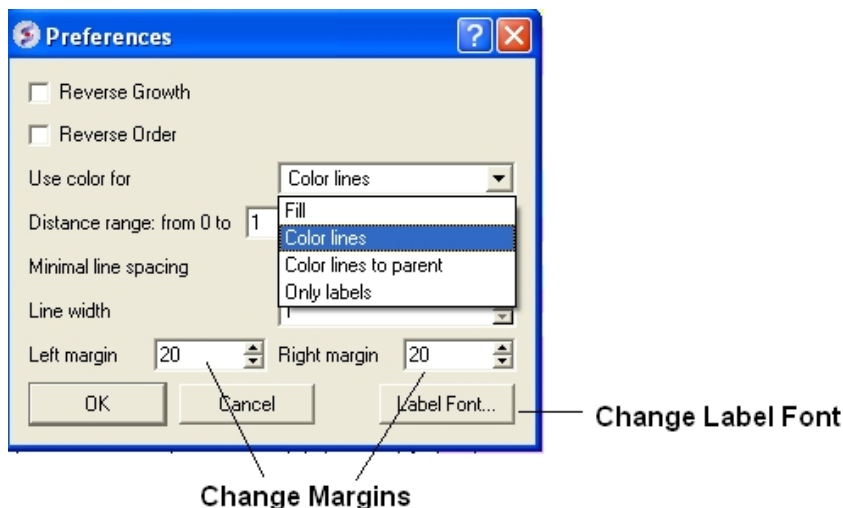

Change Label

To change the tree labeling (GLOBAL):

* Right click in the "free area" and select the Label/Sort option.

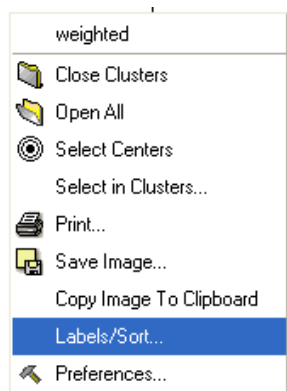

A window as shown below will be displayed:

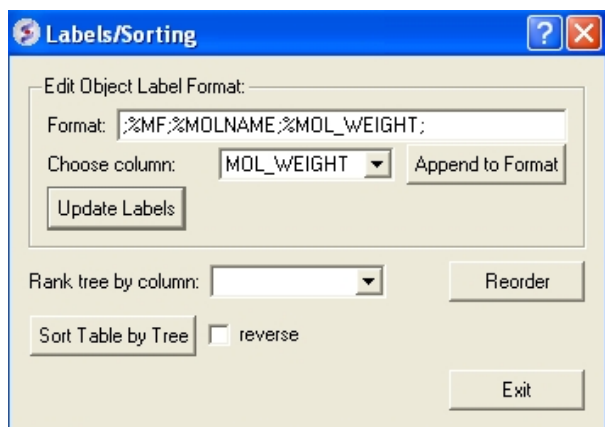

- Choose the column name you wish to label the elements of your tree.
- Click the Append to Format button. You may wish to delete some of the information in the Format data entry box if you do not wish that column header to be displayed. Note more than one column header can be used as a label.
- Click the update labels button to view the changes.

To change the tree labeling (NODE):

- Right click on the node you wish to change the label of and select "Edit Label" and a data entry box as shown below will be displayed.

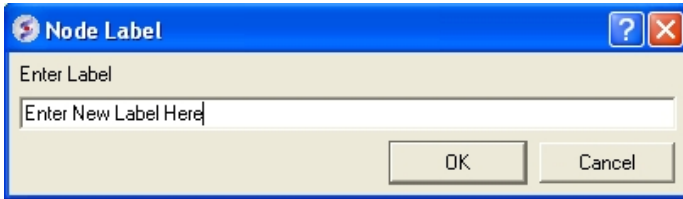

- Enter the new label.

Change Node Coloring

To change the color of a node:

- Right click on the node you wish to change the color of and select "Edit Color".
- Select the desired color and click OK.

9 Working with Local Databases

ICM tables are capable of storing tens of thousands records. However, some problems operate with data sets so large that they do not fit in computer's memory. To work with such large amounts of data ICM uses the concept of Molsoft database (MOLT) files. Unlike many other table file formats, such as SDF, CSV and others, database files are optimized for fast search and other operations, like unique entry addition and diverse subset selection.

Database files do not provide all the functionality available for tables but they allow the user to organize large amounts of data, search data using various advanced criteria and share created data collections with other users. For large amounts of chemical data database files provide specialized chemical functionality.

ICM provides the following database file operations:

- create database files from SDF, CSV/TSV, SMILES files and from ICM tables;
- impose unique constraints on certain columns upon table creation to avoid redundancy;
- store multiple tables in a single file; rename, delete tables in a database file;
- search fast using advanced conditions, including advanced chemical search;
- select diverse subsets from chemical database files;
- browse database tables using flexible filtering and sorting conditions;
- directly edit/delete/insert entries in the database;
- export in popular formats, such as SDF (for chemistry) and CSV;
- export and import tables to and from Molcart.

Chapter Contents:

- How to make a local database
- Browse Database
- Edit Database
- Query Local Database

9.1 How to make a local database.

Available in the following product(s): ICM-Chemist | ICM-Chemist-Pro | ICM-VLS

To convert a file into MOLT format.

- File/Convert large SDF, CSV to Database (molt).
- A **Database Import** dialog box will be displayed. Select the fields you wish to import.
- Once the file has been converted to MOLT and imported then it will be displayed in the ICM Workspace.
- Double click on the file name in the ICM workspace and the database browse mode will activated.

9.2 Browse Database

Available in the following product(s): ICM-Chemist | ICM-Chemist-Pro | ICM-VLS

To browse a database first decide how many rows of your database you wish to view

- Double click on the file name in the ICM workspace and the database browse mode will be activated.
- Select the number of rows you wish to be displayed in the **Limit** data entry box.
- Click on the **Apply** button.
- Scroll up and down the displayed rows using the scroll bar on the right hand side of the table.

1. Enter Number of Rows to Display

2. Press Apply

3. Scroll Up or Down

```

icm/def> load moicart table celebrex50 sort="MOLWEIGHT" filter="" number=1000
icm/def> load moicart table celebrex50 sort="MOLWEIGHT" filter="MOLWEIGHT > 100." number=1000
icm/def> load moicart table celebrex50 refresh
icm/def> load moicart table celebrex50 refresh
icm/def>

```

database table: 46 rows [of 50], 7 columns.

To sort a database by a value in a column

- Click on the drop down arrow next to the **Sort by** data entry box and select a column.
- Click on the **Apply** button.

NOTE: The database will be sorted globally not just the displayed rows.

1. Select the Column to Sort

2. Press Apply

```

icm/def> load moicart table celebrex50 sort="MOLWEIGHT" filter="" number=1000
icm/def> load moicart table celebrex50 sort="MOLWEIGHT" filter="MOLWEIGHT > 100." number=1000
icm/def> load moicart table celebrex50 refresh
icm/def> load moicart table celebrex50 refresh
icm/def>

```

database table: 46 rows [of 50], 7 columns.

To filter a database:

- Double click on the panel labeled and the filtering tools will be activated.

The screenshot shows the ICM 3.6.1a software interface. A table with 46 rows and 7 columns is displayed. The columns are: mold, mol, MOLDHF, DRUGLIKENESS, MOLLOGP, MOLWEIGHT, and IUPACNAME. The first row shows a chemical structure and values: -146.3, -1.031, 3.962, 381.4. The second row shows a chemical structure and values: 30, -13.21, -1.385, 0.1217, 111.1, and 6-hydroxy-2,3-dihydro-1,2-diazin-3-one. A callout box with the text "Double click here to activate filtering tools" points to the 'Apply' button in the top right of the table area.

- Click and select a column to filter (as shown below).
- Enter a condition.
- Enter a value.
- Add or remove another condition
- Click the **Apply** button

The screenshot shows the ICM 3.6.1a software interface with the filtering process highlighted by numbered callouts:

1. Click and Select Column: Points to the 'MOLWEIGHT' column header.
2. Select Condition: Points to the '>' operator in the filter bar.
3. Enter Value: Points to the value '350' entered in the filter bar.
4. Add a New Condition or Remove: Points to the '+' and '-' buttons in the filter bar.
5. Apply Filter: Points to the 'Apply' button in the top right of the table area.

 The table below shows the filtered results, with only the second row visible. The columns are: mold, mol, MOLDHF, DRUGLIKENESS, MOLLOGP, MOLWEIGHT, and IUPACNAME. The values are: 2, 6-hydroxy-2,3-dihydro-1,2-diazin-3-one, 30, -13.21, -1.385, 0.1217, 111.1.

To view a diverse set of rows from your database:

- Right click on the database in the ICM Workspace and select **Select Diverse Set**.

9.3 Edit Database

Available in the following product(s): ICM-Chemist | ICM-Chemist-Pro | ICM-VLS

To make any changes to a database you must first unlock it:

- Click on the **Allow editing rows** button which has a picture of a lock on it.
- Once this button has been selected the **Delete Rows**, **New Row**, and **Update DB** buttons will become activate.

The screenshot shows the ICM-Chemist software interface. The main window displays a table with the following data:

molid	mol	MOLDHF	DRUGLIKENESS	MOLLOGP	MOLWEIGHT	RUPACNAME	
1	<chem>C1=CC=C(C=C1)N2C(=O)C(=O)N2C3=CC=CC=C3</chem>	-146.3	-1.031	3.962	381.4		
6	<chem>C=CC=O</chem>	30	-13.21	-1.385	0.1217	111.1	6-hydroxy-2,3-dihydro-1,2-diazin-3-one

The command line at the bottom shows the following commands:

```
icm/def> load molcart table celebrex50 sort="MOLWEIGHT" filter="" number=1000
icm/def> load molcart table celebrex50 sort="MOLWEIGHT" filter="MOLWEIGHT > 100." number=1000
icm/def> load molcart table celebrex50 refresh
icm/def> load molcart table celebrex50 refresh
icm/def>
```

To delete rows

- Select the row(s) by clicking on the row numbers. A range of rows can be selected by holding the shift key and clicking a non-contiguous set of rows can be selected by holding down the control key.
- Click the **Delete Rows** button.

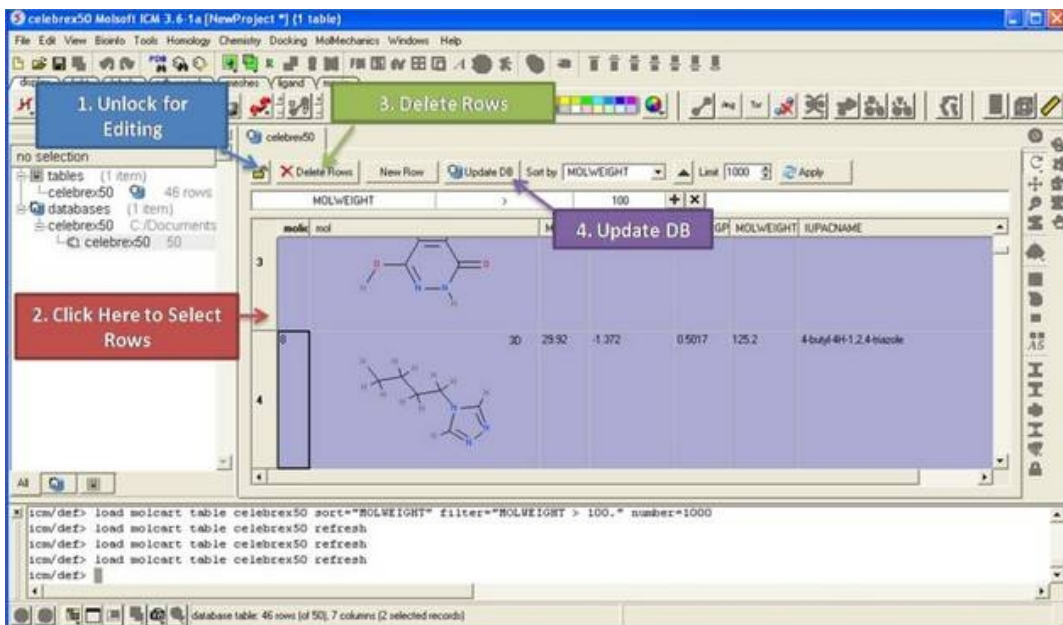

To insert a new row

- Select a row.
- Click on the **New Row** button. A new row will be inserted underneath the selected row.
- Click **Update DB**

To edit strings and numbers in a row

- Double click on the cell you wish to edit and then enter a new value.
- Click **Update DB**

To edit a chemical (2D sketch):

- Right click on the cell and select **Edit Molecule**
- Make changes using the Molecular Editor
- Click **Update DB**

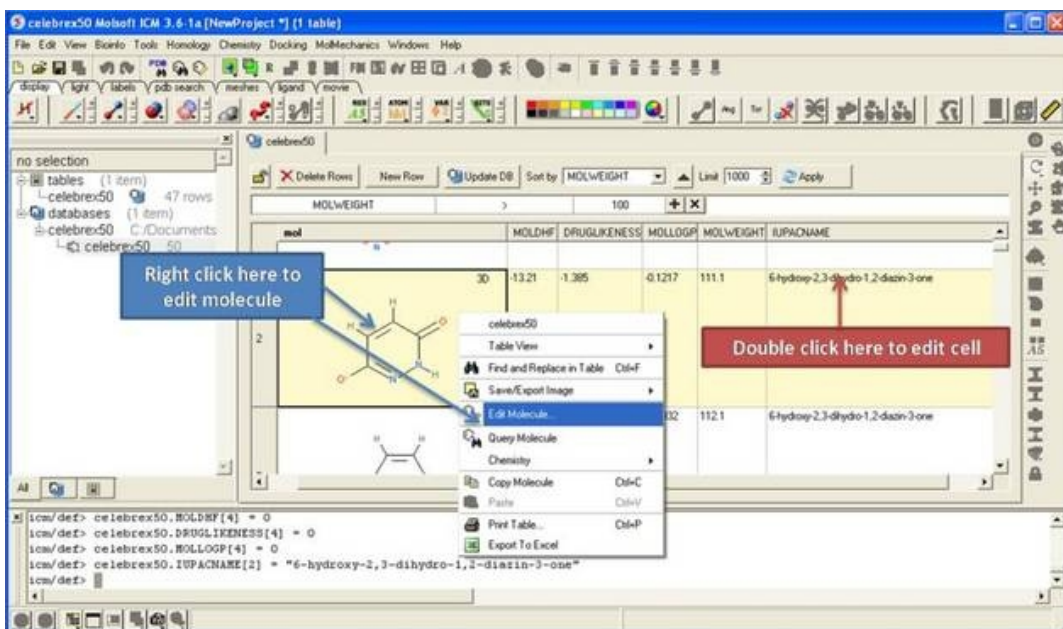

9.4 Query Local Database

Available in the following product(s): ICM-Chemist | ICM-Chemist-Pro
| ICM-VLS

To query a local database:

- Right click on the database in the ICM Workspace and select **Query**.
- Query using the chemical search tools.

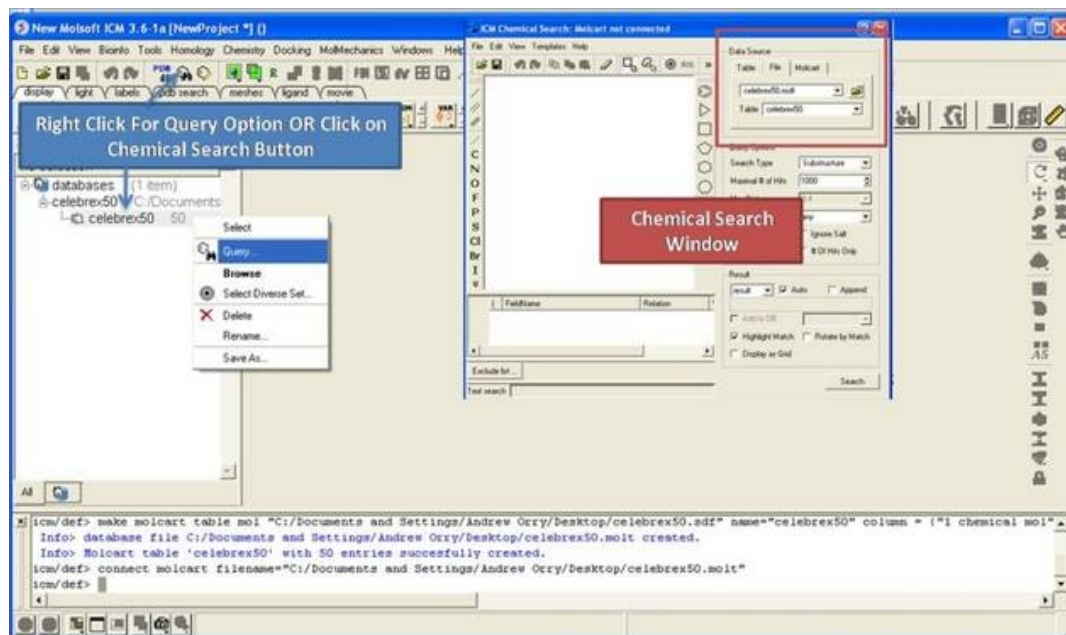

10 Tutorials

Graphics Tutorials		
Molecule Representation, Coloring, Labeling and Annotation	HTML	
Creating Fully Interactive Slides for PowerPoint and the Web	HTML	Reference Guide Webinar
Sequence and Alignment Tutorials		
Read Sequences and Align	HTML	Video
Link Sequence to Structure	HTML	Video
Alignment Annotation	HTML	
Protein Structure Tutorials		
PDB Search	HTML	
Convert PDB to ICM Object	HTML	
Superimpose Proteins	HTML	
Structure Analysis	HTML	
Calculate contacts	HTML	
Display hydrogen bonds	HTML	
Identify ligand binding pockets	HTML	
PDB Preparation: Symmetry	HTML	
PDB Preparation: Occupancy & B-Factors	HTML	
PDB Preparation: Alternative Orientation	HTML	
PDB Preparation: Biomolecule	HTML	
Protein Modeling Tutorials		
Building an Homology Model	HTML	
GPCR Modeling Example	HTML	
Loop Modeling	HTML	
Predicting the Effect of a Mutation on Binding	HTML	
Predicting the Effect of a Mutation on Stability	HTML	
Cheminformatics Tutorials		
Chemical Sketching using the Molecular Editor	HTML	Reference Guide
Chemical Search	HTML,	Reference Guide
Chemical Clustering	HTML,	
Working with Large Chemical Space	HTML,	
3D Pharmacophore Search	HTML	Video
2D Pharmacophore Search	HTML	Video
How to Create a Markush Structure	HTML	Video
How to Enumerate a Markush Library	HTML	Video
How to Decompose a library based on a Markush Library	HTML	Video
How to Enumerate a library by reaction	HTML	Video
Detecting Activity Cliffs	HTML	
Atomic Property Fields (APF)		
APF Superposition, Score, Consensus, Screening and Clustering.	HTML	
Ligand Editor Tutorials		
Working with the ICM Interactive 3D Ligand Editor	HTML	Reference Guide.
Ligand Docking Tutorials		
Dock Biotin to the Streptavidin Receptor	HTML	Video
Re-Dock an Inhibitor to Ricin Crystal Structure	HTML	Video

Covalent Docking	HTML	Video
Protein-Protein Docking Tutorial		
Protein-Protein Docking using FFT Method	HTML	
Virtual Screening Tutorials		
Virtual Ligand Screening to Ricin Receptor	HTML	
Virtual Ligand Screening to Cyclooxygenase	HTML	Video-1 <u>Video-2</u>
Docking a Markush Library	HTML	
Induced Fit Docking Tutorials		
Multiple Receptor Conformation Ensemble Docking Example	HTML	
Explicit Group Docking	HTML	
QSAR Tutorials		
2D FingerPrint QSAR Model	HTML	
2D 3D Pharmacophore QSAR Model	HTML	

10.1 Graphics Tutorials

Introduction

The following examples are focused on the structure of the kinase catalytic domain. The catalytic domain is nestled between the N- and C-terminal and has high sequence conservation between kinase families. The adenine moiety of ATP interacts with the hinge region which links the N- and C-terminals of the catalytic domain. The ATP sugar binding region is on the "floor" of the pocket where ribose makes a hydrogen bond with a polar residue. A conserved lysine residue on the beta3 strand is part of the "roof" of the pocket where the triphosphate group of ATP binds. A flexible glycine-rich loop moves in and out of the pocket depending on the ligand bound state of the PK and is regulated to some extent by the movement in and out of the pocket by the AlphaC helix. A buried region at the "back" of the pocket is protected by a "gatekeeper residue" forming a variable hydrophobic cavity. The hydrophobic cavity along with the DFG motif region are of interest for drug design because it opens up regions of the pocket which are not conserved and do not bind ATP.

To learn the basics of the graphical user interface we will annotate the key structural regions of a protein kinase.

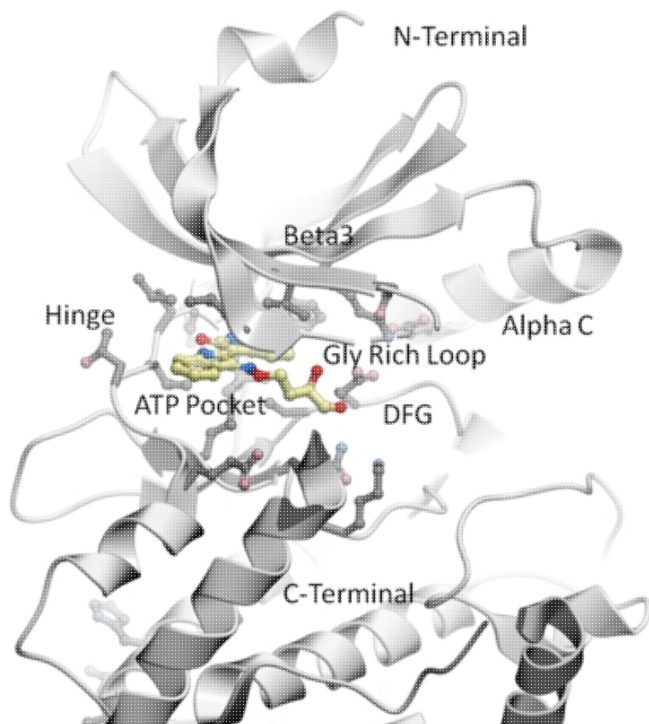

10.1.1 Change Molecule Representation and Color

This tutorial shows you how to:

- How to load a PDB structure into ICM.
- How to change the background color.
- How to display and undisplay a molecule.
- How to color ribbon representation.

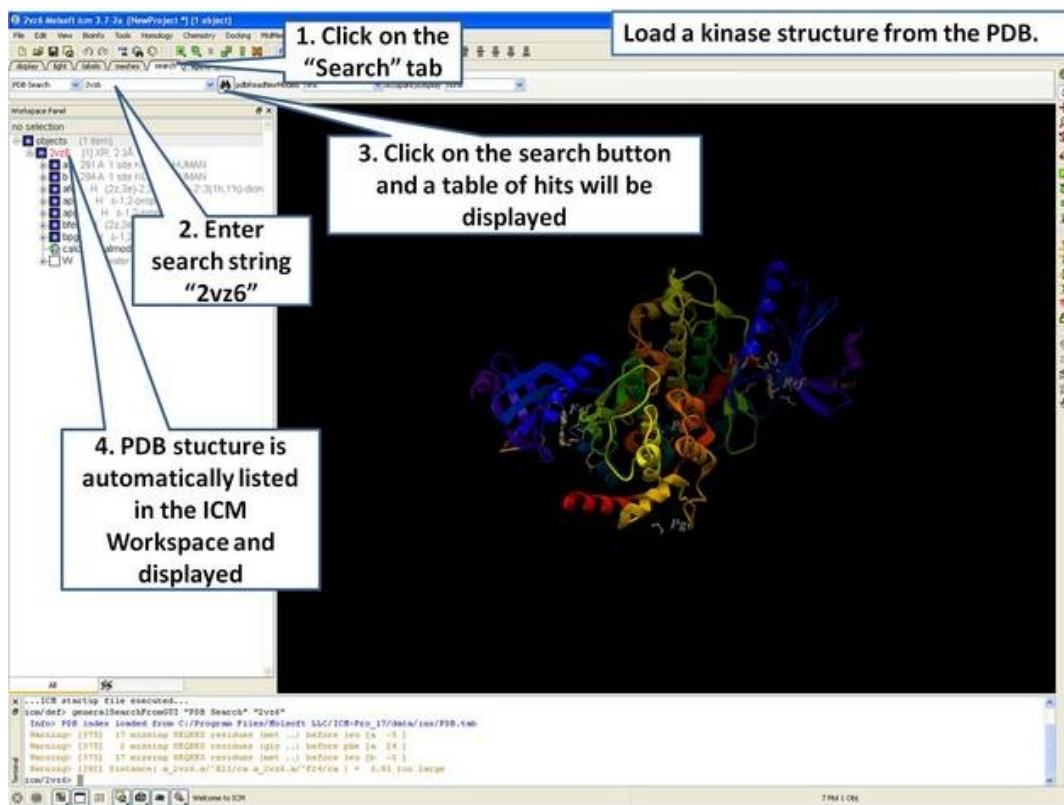

Step 1: Click on the search tab to load and display the PDB structure 2vz6

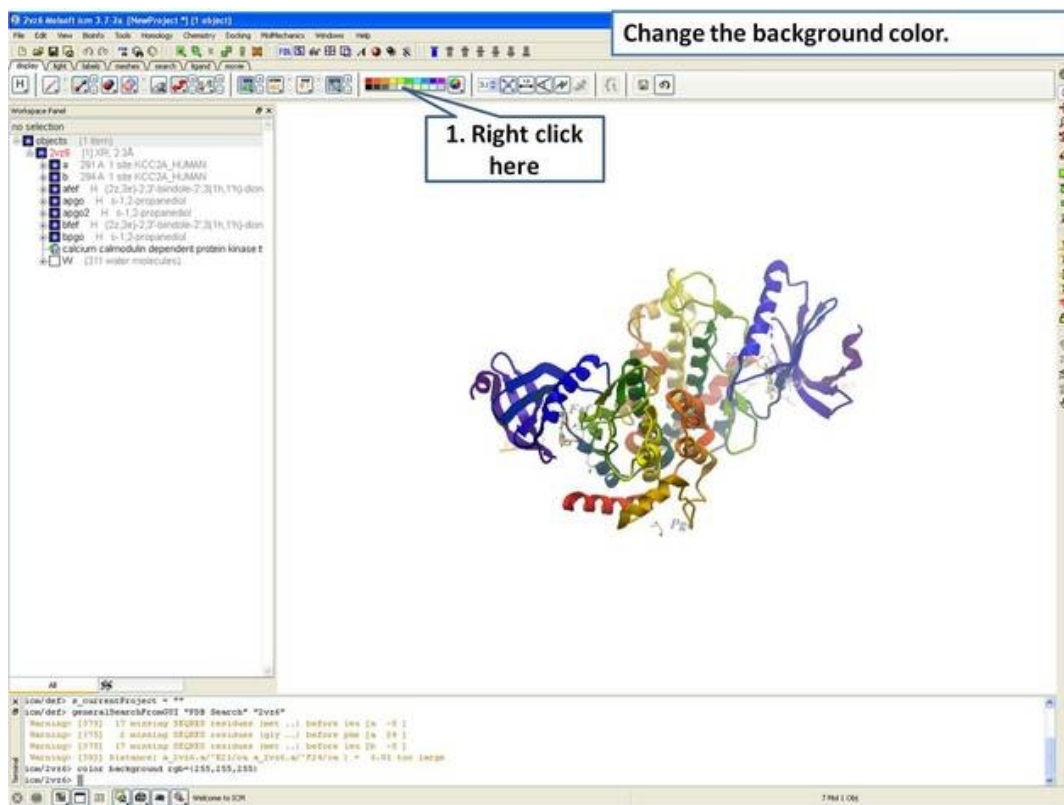

Step 2: Change the background color by right clicking on the color palette.

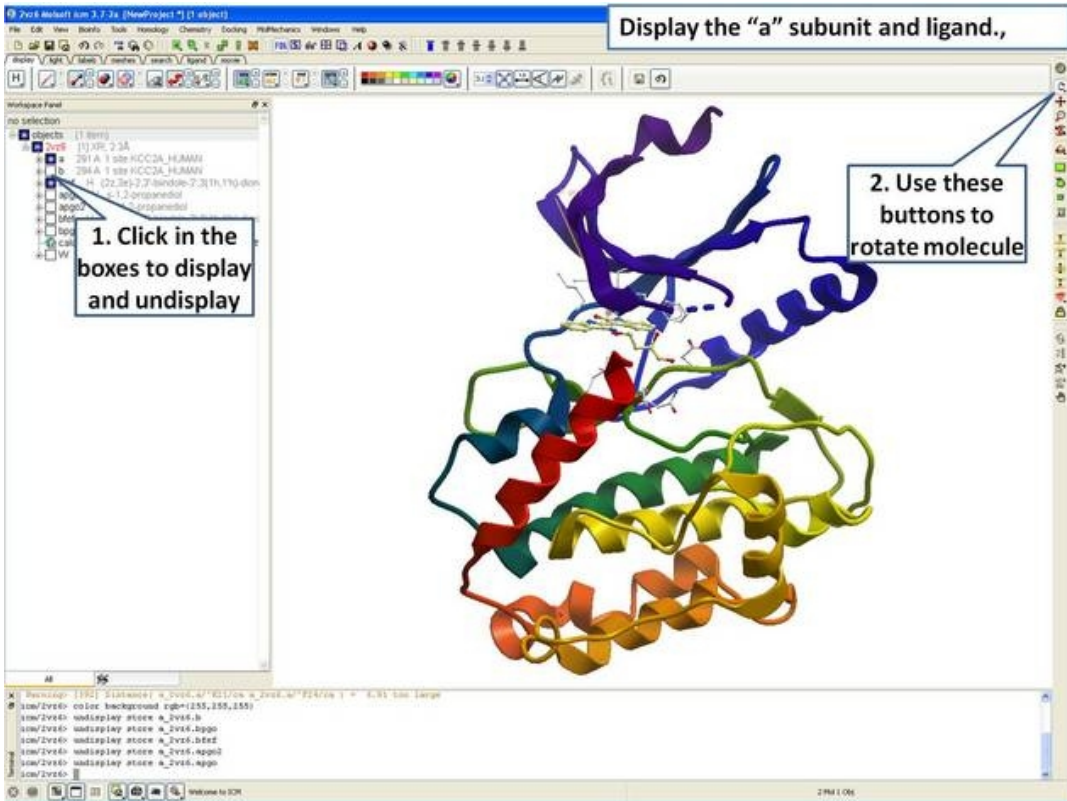

Step 3: Display the "a" subunit of the kinase.

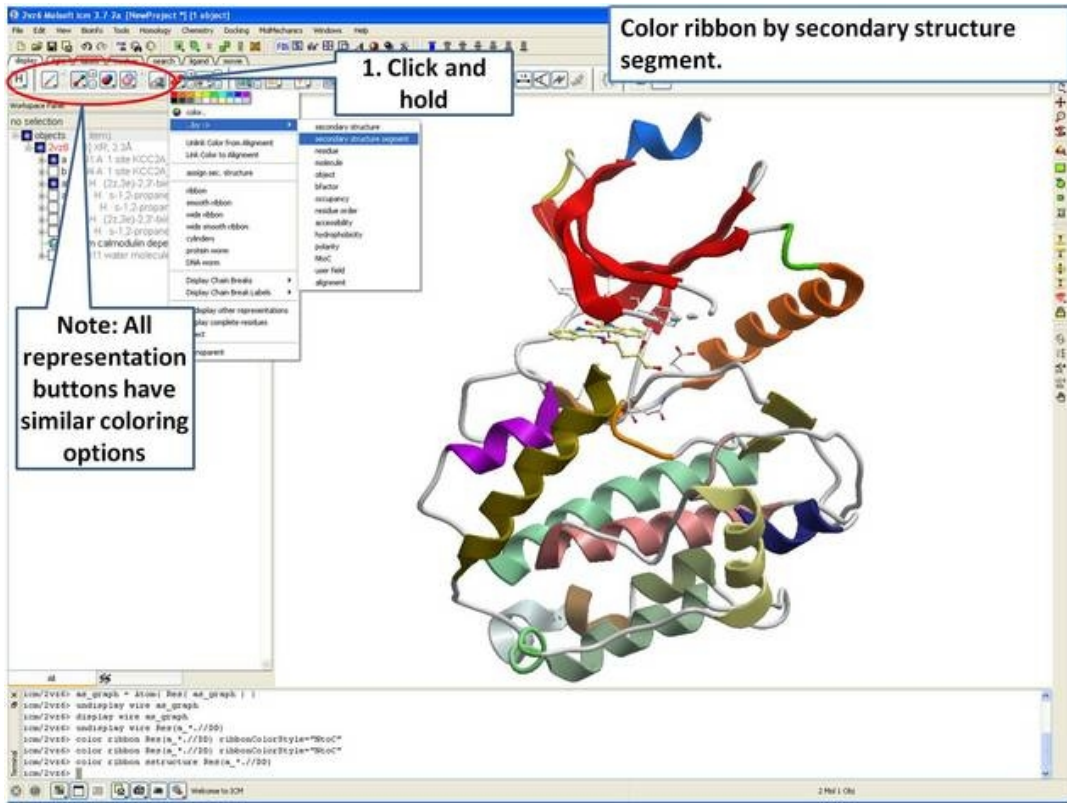

Step 4: Use the options in the "Display Tab" to color the ribbon.

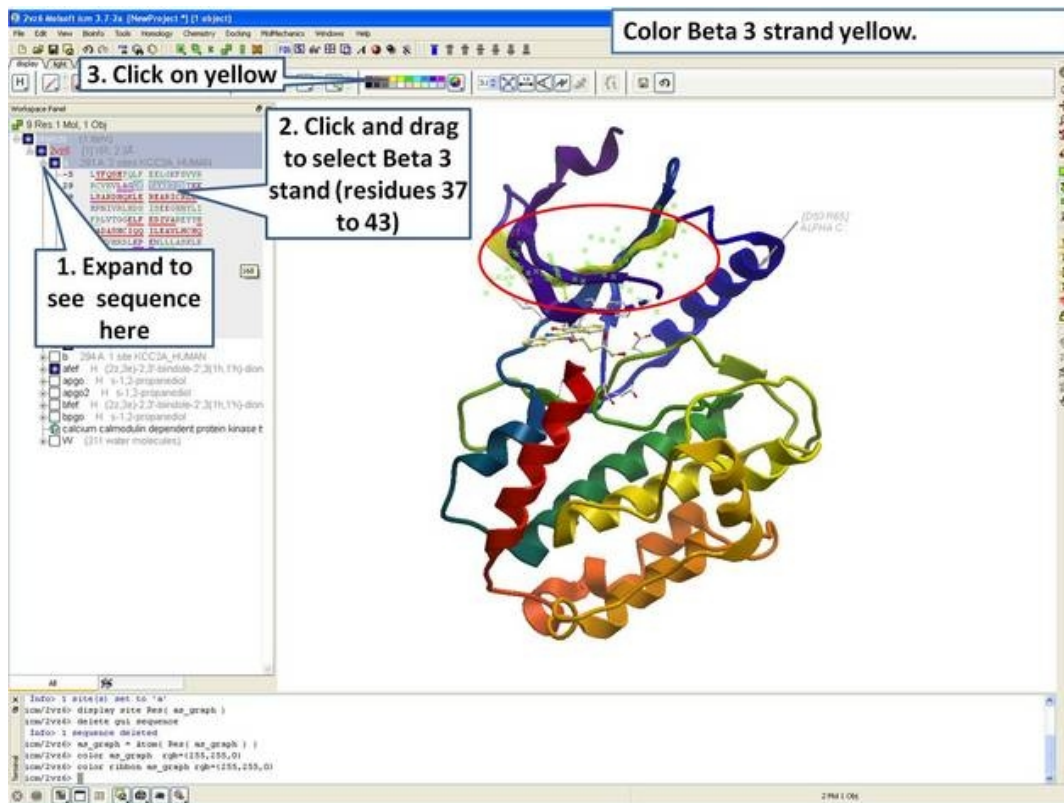

Step 5: Select the beta 3 strand (residues 37:43) and color yellow.

10.1.2 Annotation

This tutorial shows you how to add user defined annotation to a particular region of a protein structure.

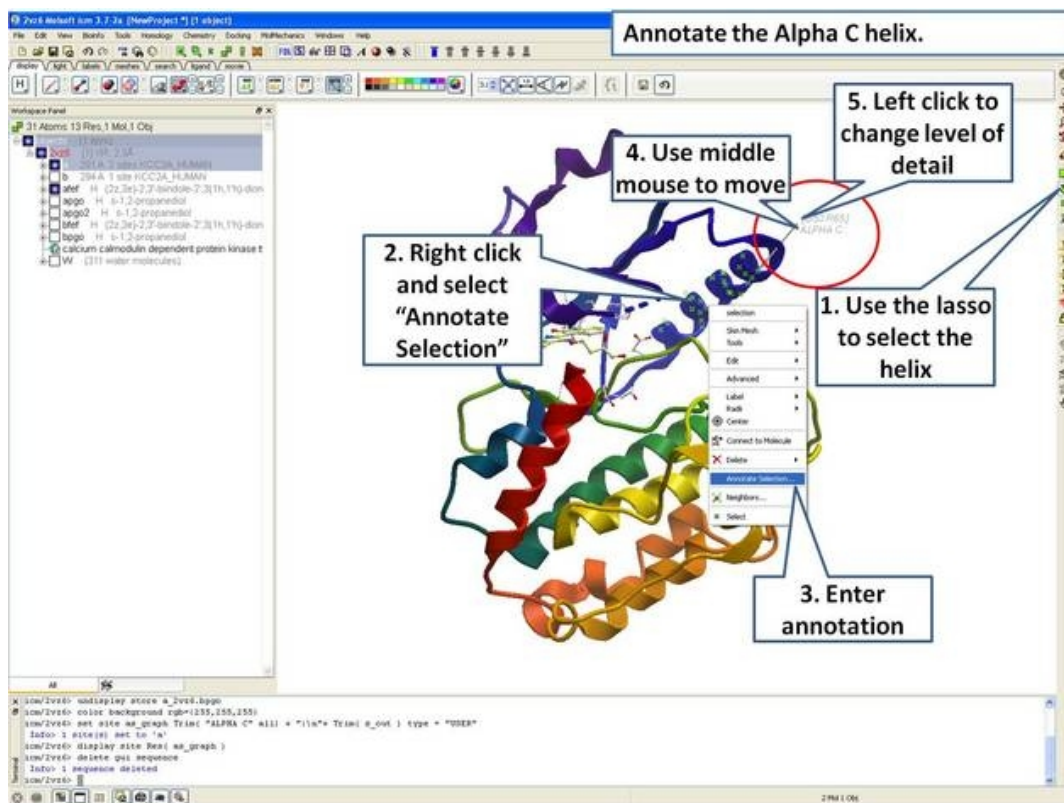

Step 6: Select the region you wish to annotate and right click on the selection for options.

10.1.3 Labels

This tutorial is a continuation from the previous tutorials in this section and shows you how to:

- How to select individual residue types.
- How to propagate a selection from one atom to all.
- How to use the residue label button.
- How to make a spherical selection.
- How to label a residue selection.

1. Click on "Filter Graphical Selection" button

2. Check the charged residues (Asp, Glu, Arg, and Lys)

Display and Label Beta 3 to Alpha C Salt Bridge (1)

Step 7: Use the "Filter Graphical Selection" button to select charged residues.

1. Click here to propagate selection to all atoms in residue

2. Click here to display all charged residues in wire

Display and Label Beta 3 to Alpha C Salt Bridge (2)

Step 8: Propagate selection to all atoms to display all atoms of the side chain.

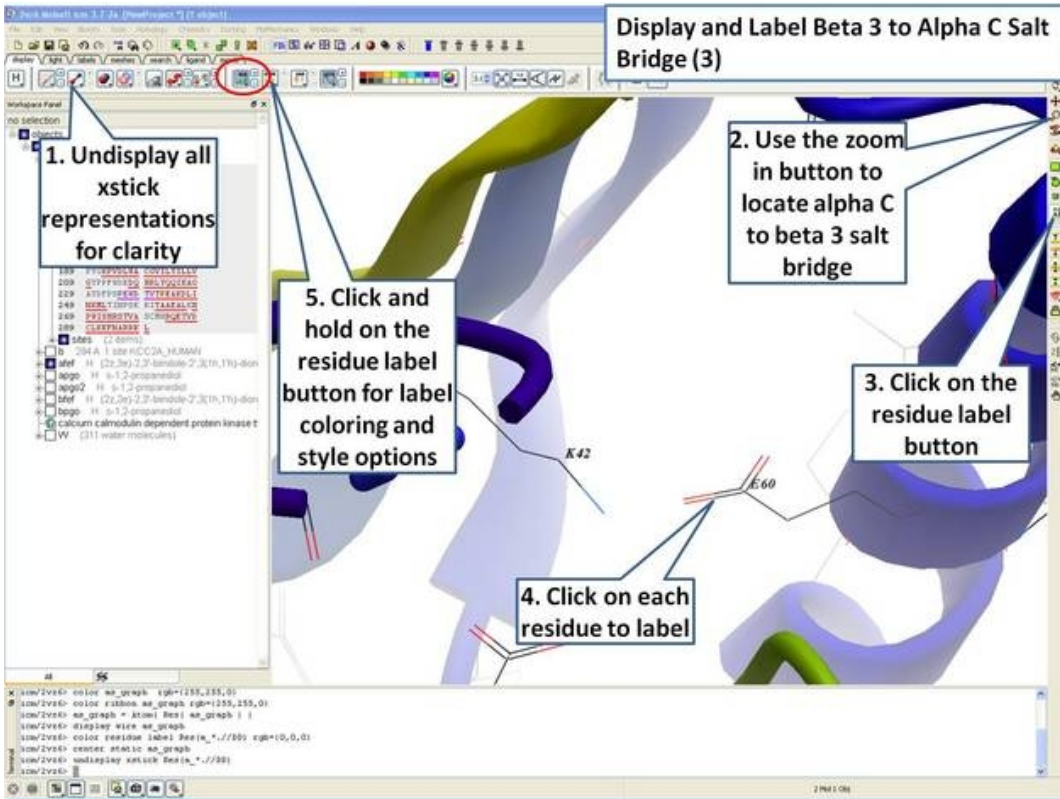

Step 9: Locate the B3 to AlphaC salt bridge (K42- E60) and label using residue label button. **Note:** Once you have selected the two residues you can invert selection (click on invert selection button) and then undisplay all the other charged residues.

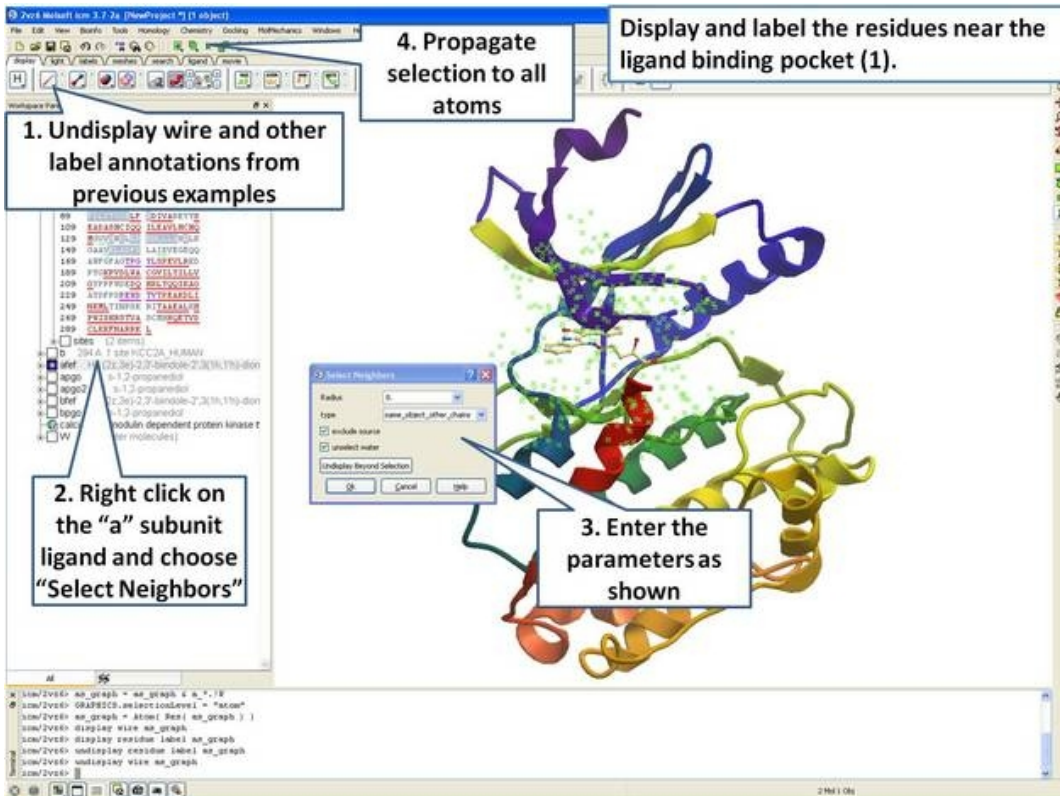

Step 10: Select neighboring residues to the ligand.

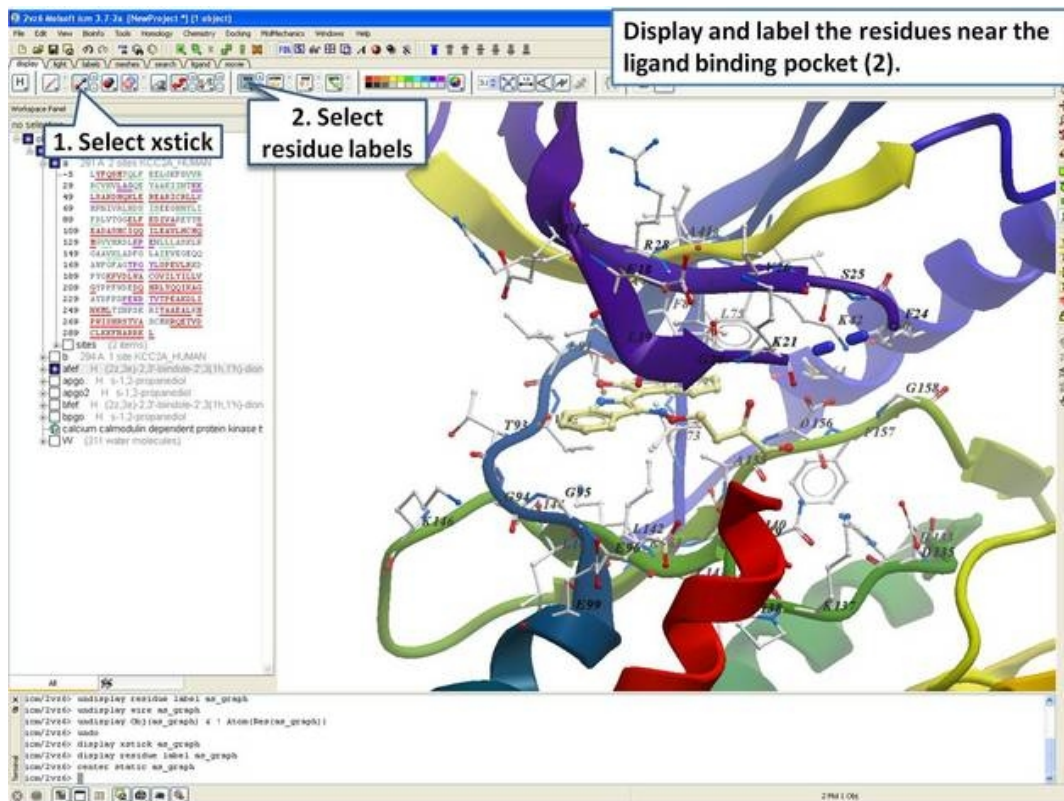

Step 11: Display the residues and label them.

10.1.4 2D and 3D Labels

This tutorial is a continuation from the previous tutorials in this section and shows you how to:

- Create and display a 2D label.
- Delete and move a 2D label.
- Create and display a 3D label.
- Delete and move a 3D label.

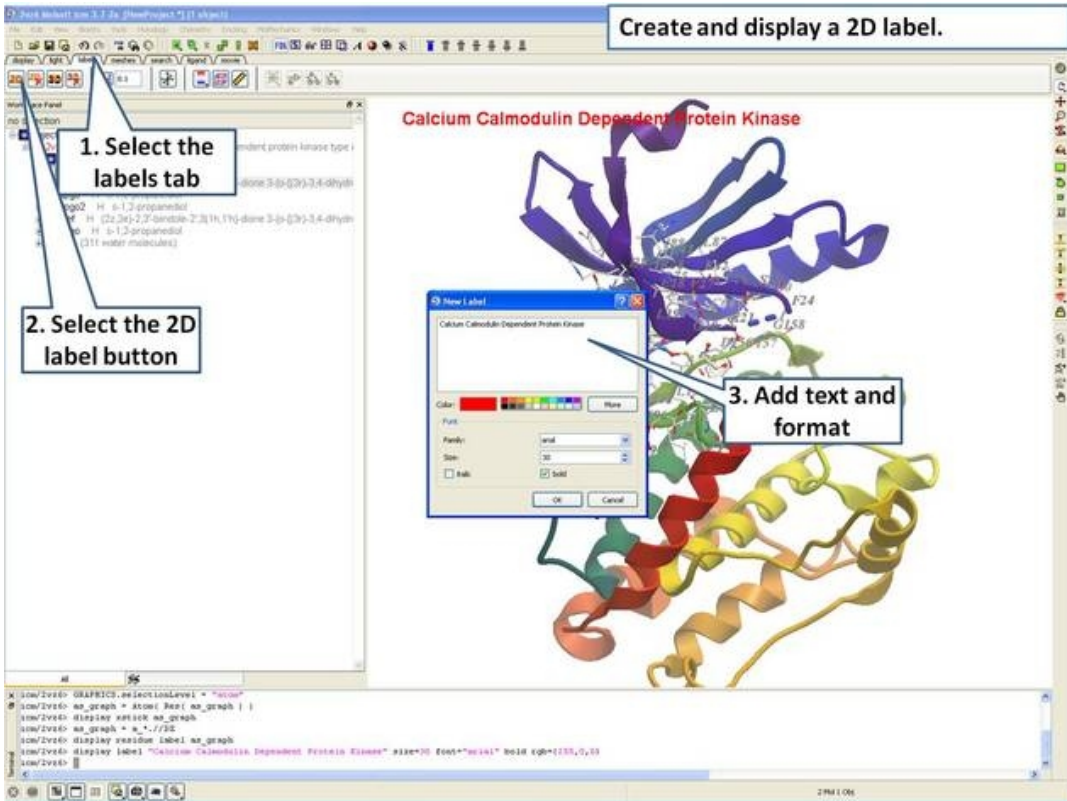

Step 12: Create a 2D label using the options in the "labels" tab.

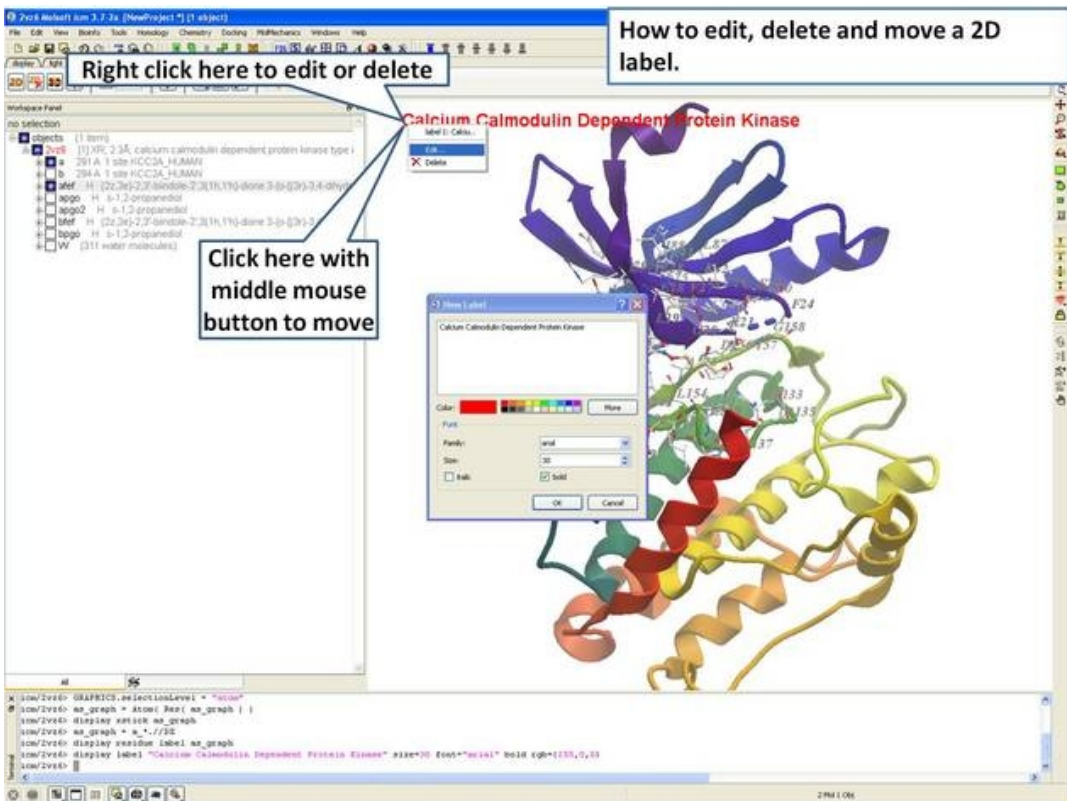

Step 13: Right click on the 2D label to edit or delete it.

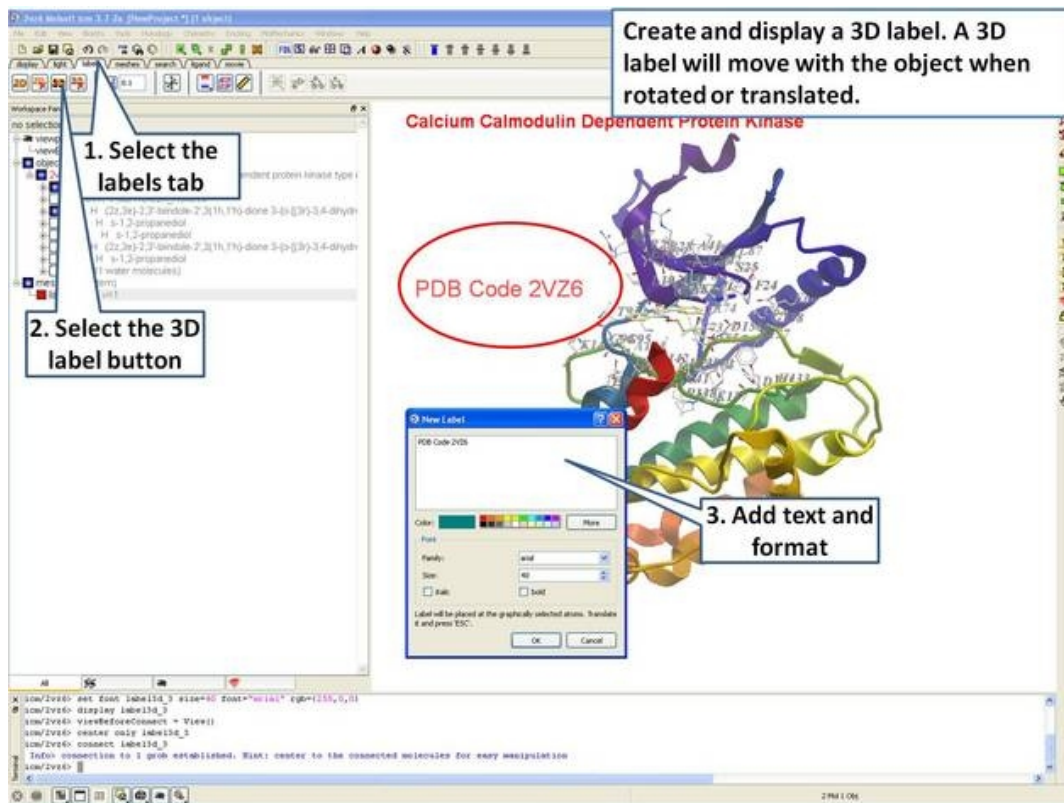

Step 14: Create a 3D label using the options in the "labels" tab.

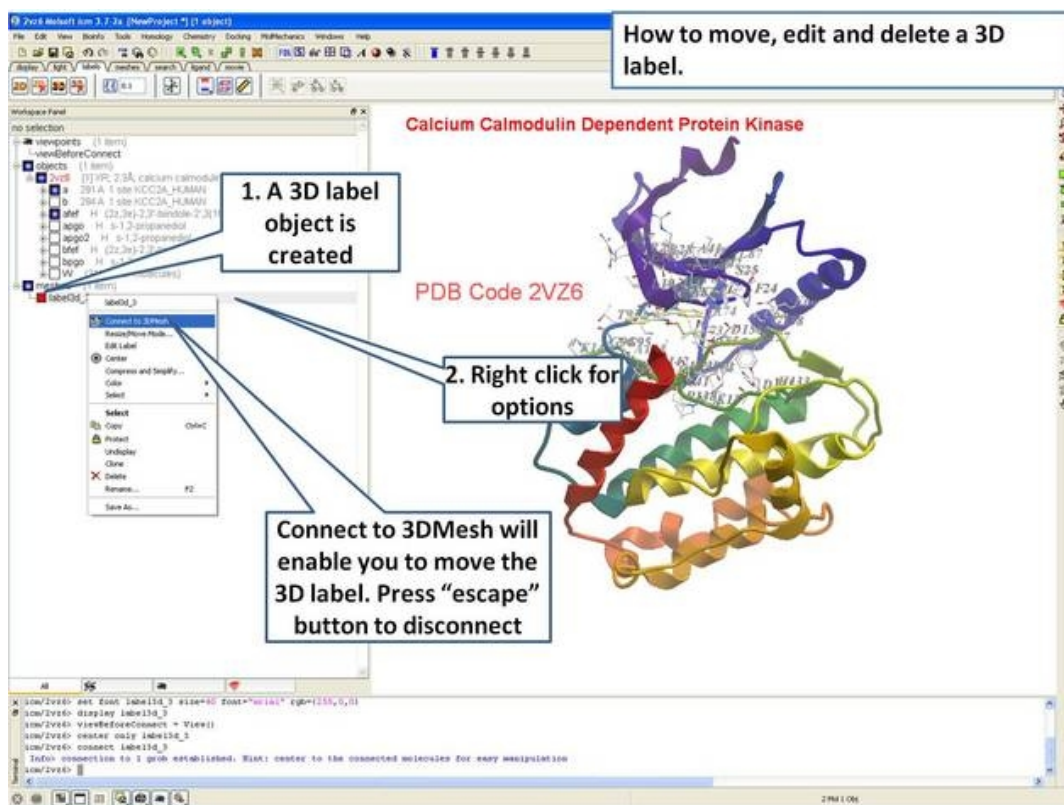

Step 15: Right click on the 3D label to edit or delete it.

10.2 Creating Fully Interactive Slides for PowerPoint and the Web Tutorial

Introduction

A slide enables you to conveniently store a large number of different 3D visualization properties (e.g. color, viewpoint, representation etc...) along with text and window layout. ActiveICM enables you to view and display ICM graphical slides and animations interactively inside Windows Microsoft PowerPoint and web browsers such as Internet Explorer and Mozilla Firefox.

In this example we are going to look at the effect of an agonist binding to the Beta-2-Adrenergic GPCR (B2AR) and prepare a molecular document. A prepared ICM file containing three B2AR GPCRs superimposed can be downloaded here <ftp://ftp.molsoft.com/pub/workshop/> (1. cut and paste the address into a web browser. 2. Right click on GPCR_slides.icb and choose "Save Link As". 3. Open the .icb in ICM File/Open). The file contains pdb files 2RH1 (R inactive state), 3P0G (R* active state, with G-alpha mimic), and 3SN6 (R*G G-protein signalling state). The agonist ligand causes Helix 5 to shift inwards and Helix 6 to swing outwards. This agonist binding poses were predicted using ICM a year before the crystal structures were solved, you can read about this [here](#) and a good review of the structure and function of GPCRs [here](#).

Tutorial

In this tutorial we will build a series of slides and then annotate them using HTML to create hyperlinks to the slides. The resulting molecular document can be exported in movie format or in fully interactive 3D files.

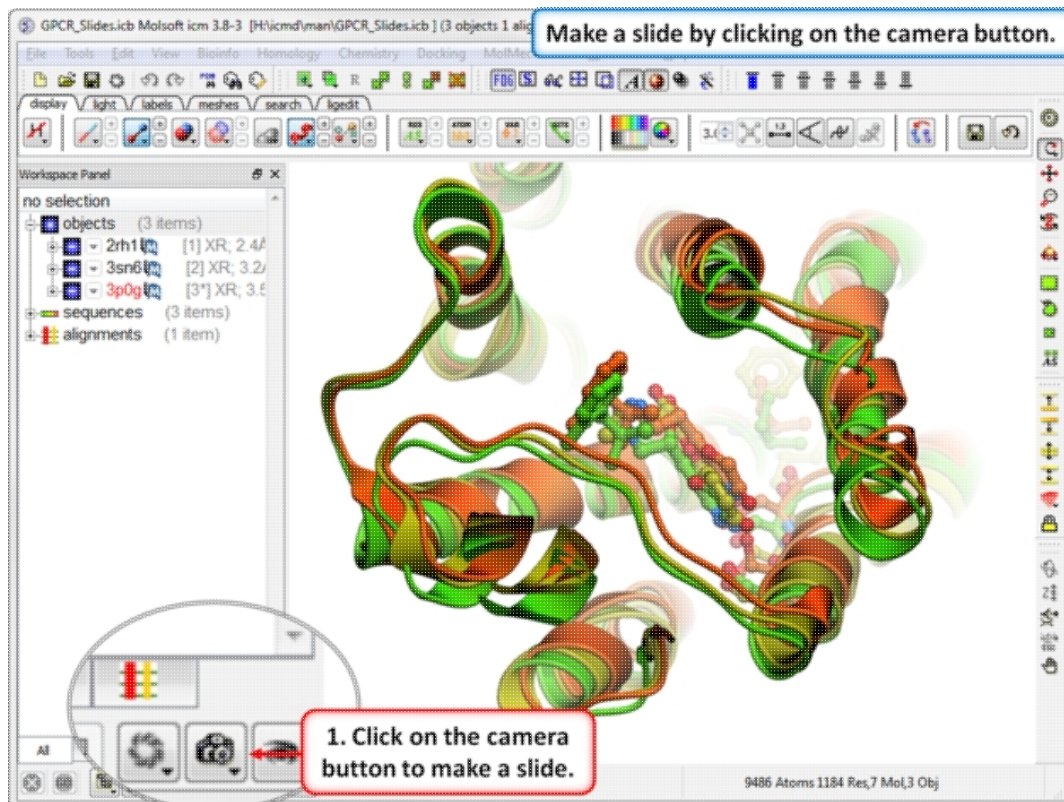

Step 1: Download the example file here

<ftp://ftp.molsoft.com/pub/workshop/> (1. cut and paste the address into

a web browser. 2. Right click on GPCR_slides.icb and choose "Save Link As". 3. Open the .icb in ICM File/Open). Make a slide by clicking on the camera button at the bottom of the GUI.

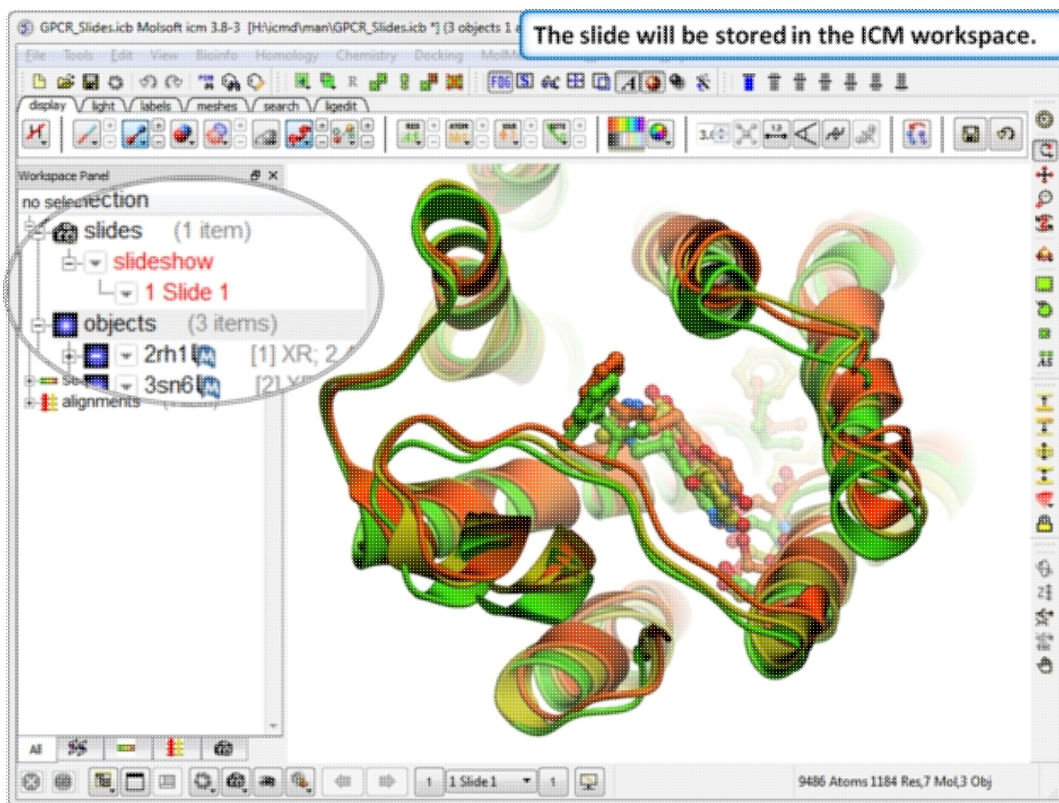

Step 2: The slide is stored in the ICM Workspace panel (left hand side of the GUI). You can make changes to the 3D display and return to the display in the slide by clicking on the slide in the ICM Workspace.

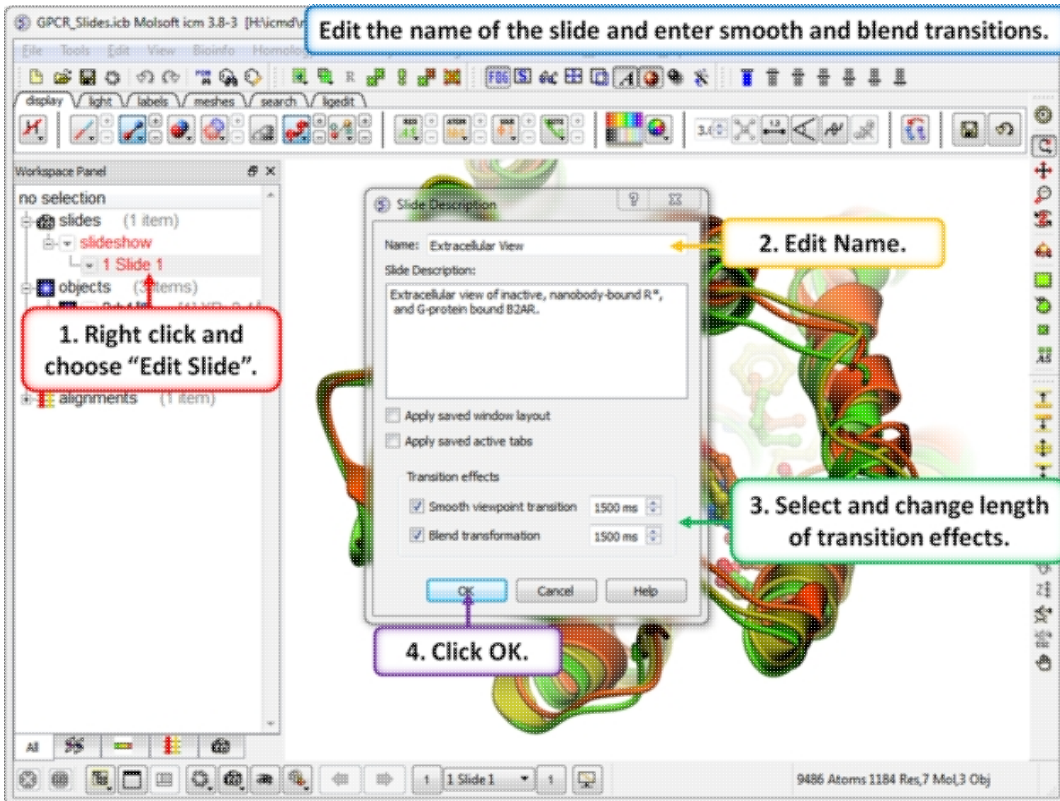

Step 3: Properties of the slide can be edited by right clicking on the slide in the ICM workspace.

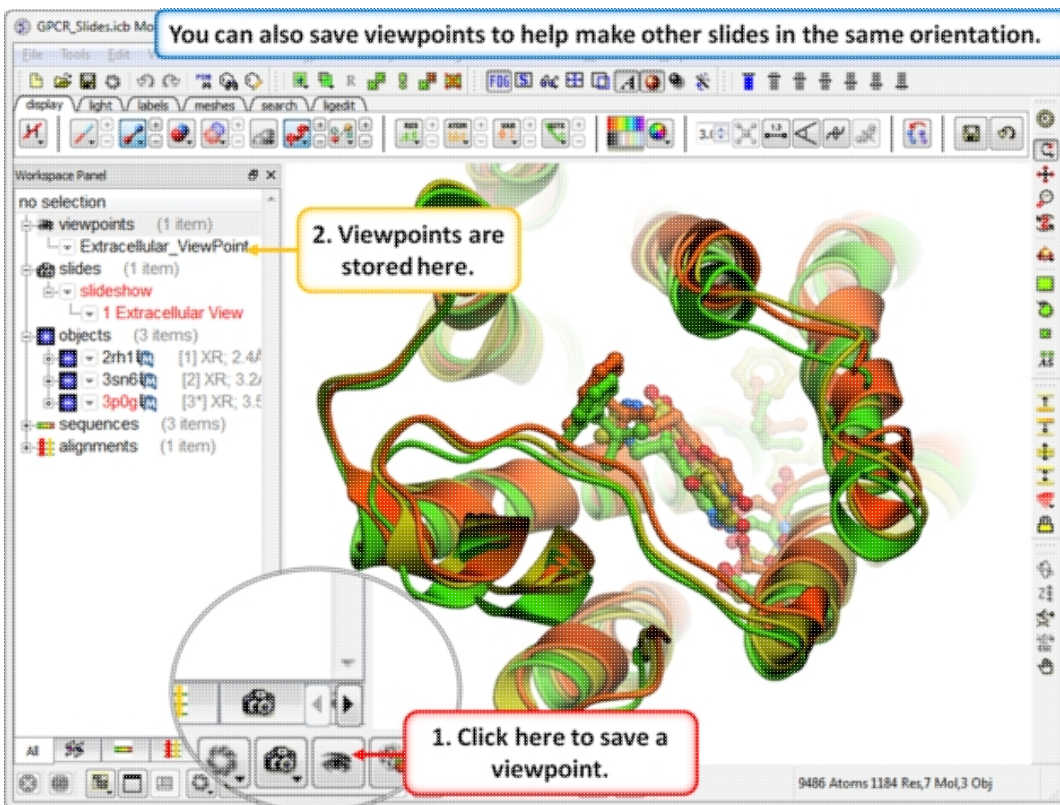

Step 4: Saving a viewpoint is useful if you are making many slides from the same viewing position.

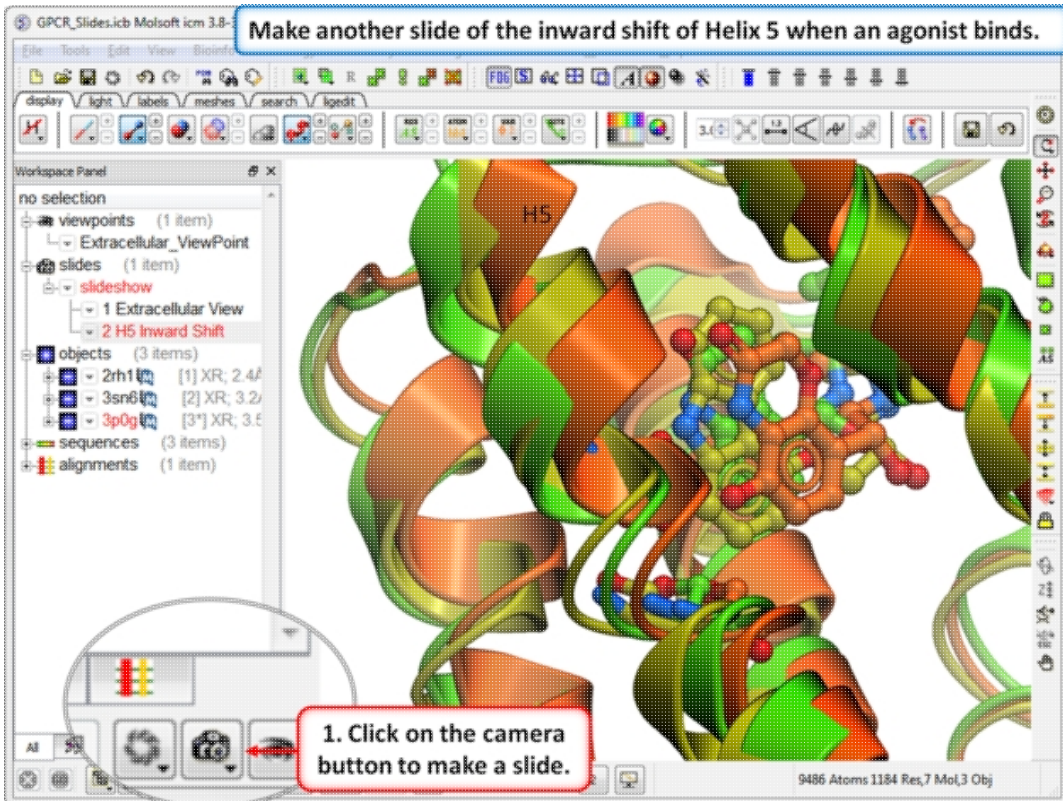

Step 5: In this slide we show that Helix 5 makes an inward shift when an agonist binds.

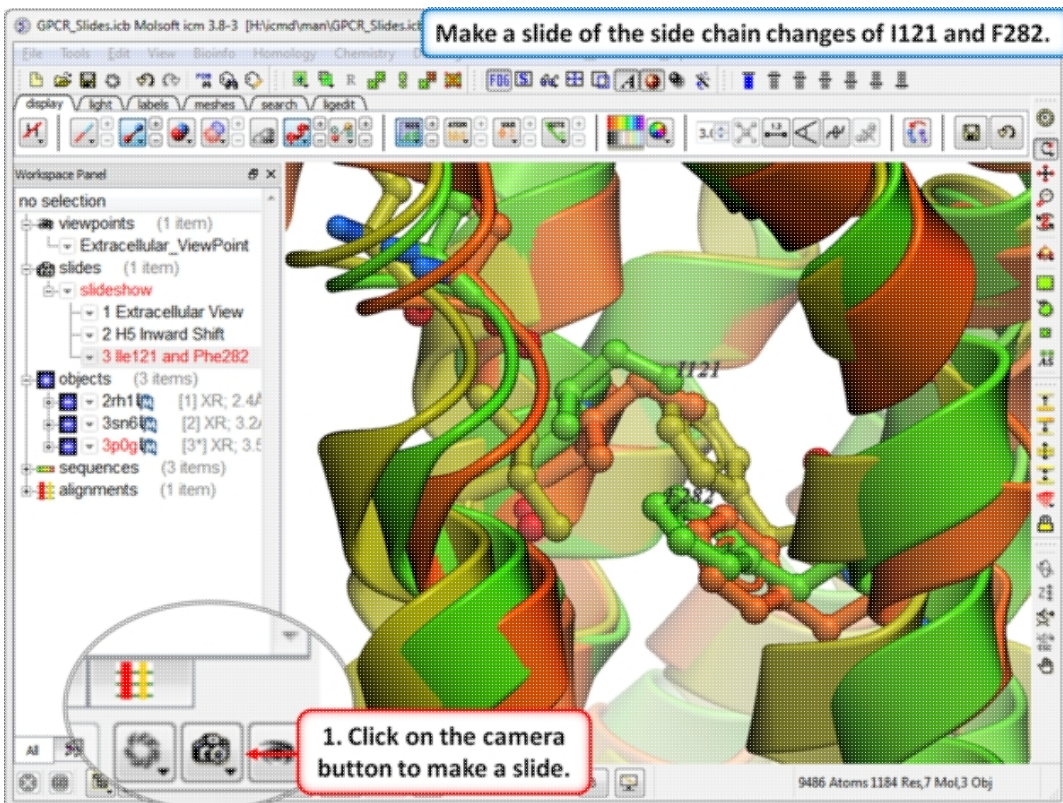

Step 6: In this slide we show that upon binding an agonist Ile121 switches its rotameric state and Phe 282 moves.

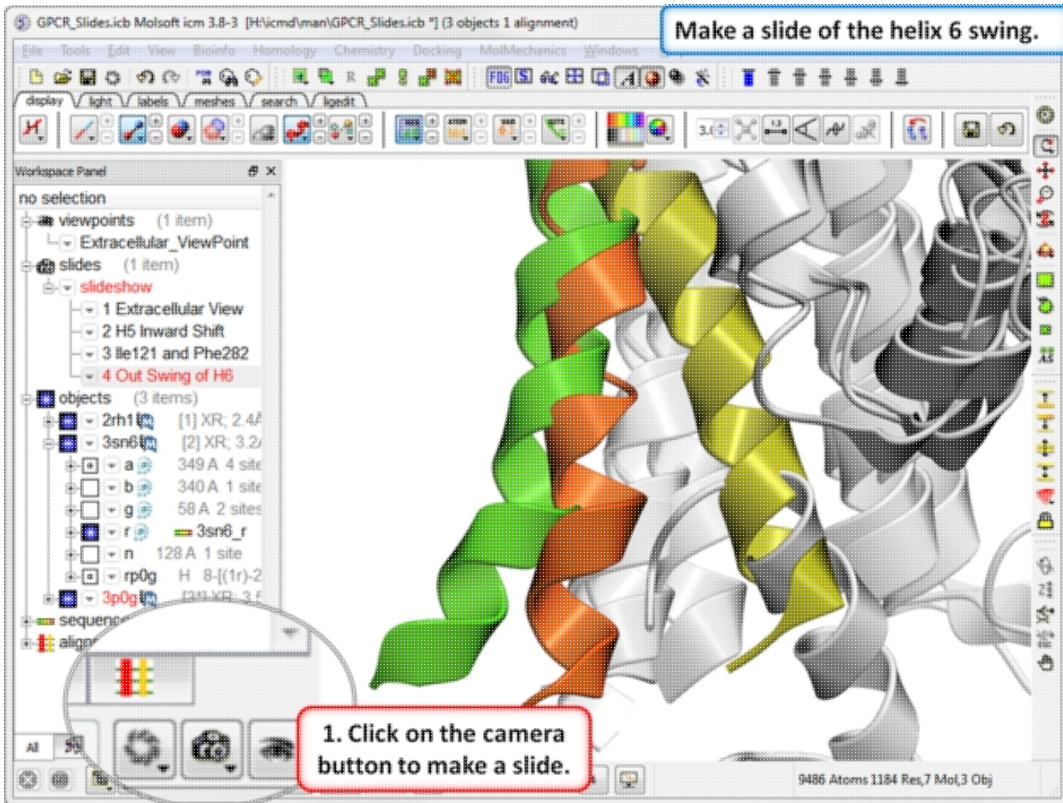

Step 7: In this slide we show that agonist binding causes Helix 6 to swing out.

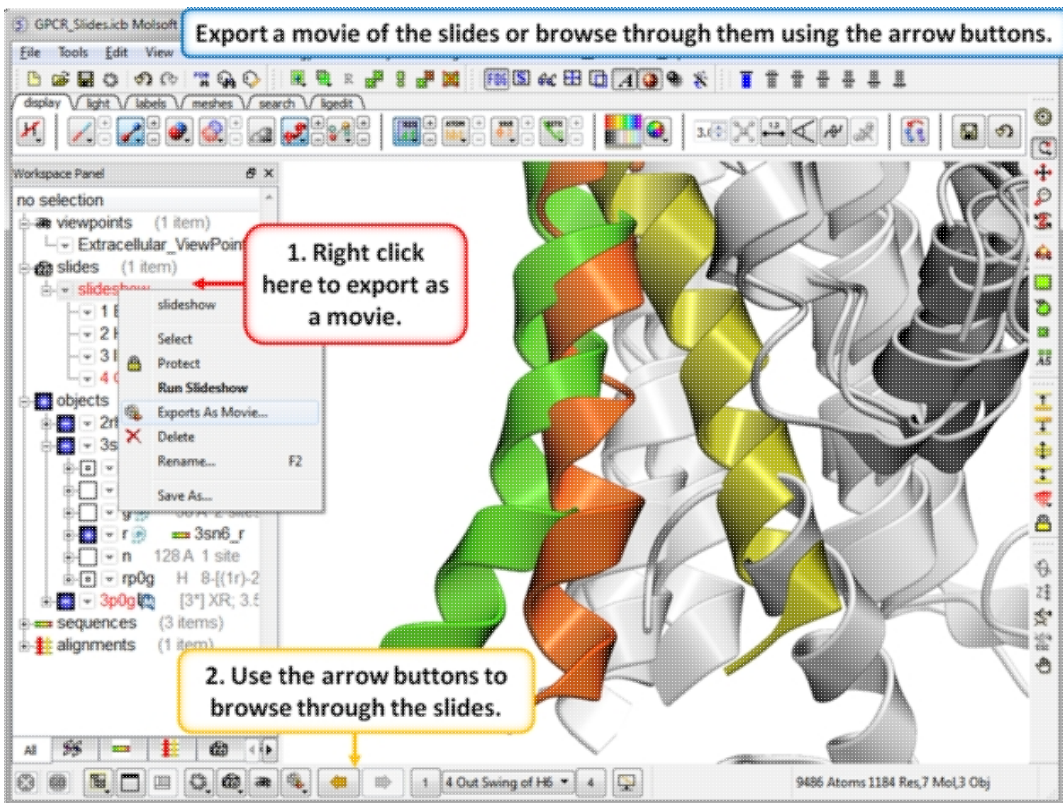

Step 8: You can export the slides as a movie or you can browse through them using the arrow buttons.

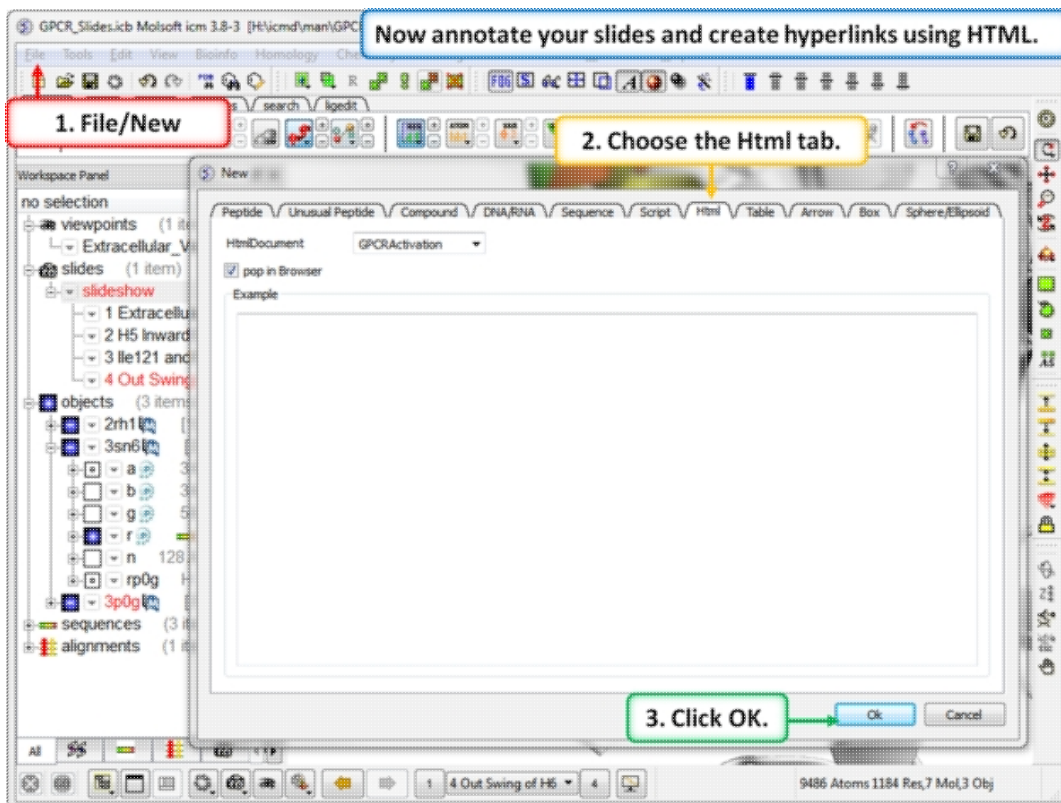

Step 9: To build a molecular document you can annotate the slides using HTML.

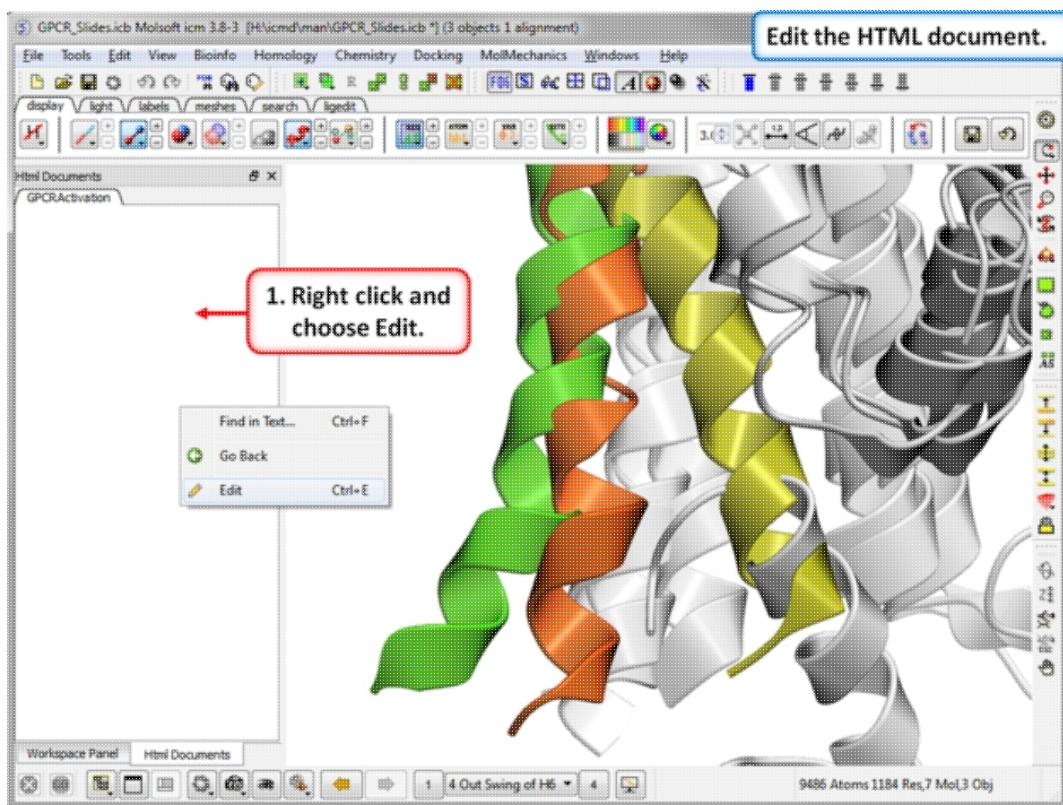

Step 10: Edit the document by right clicking on the HTML panel and choosing **Edit**.

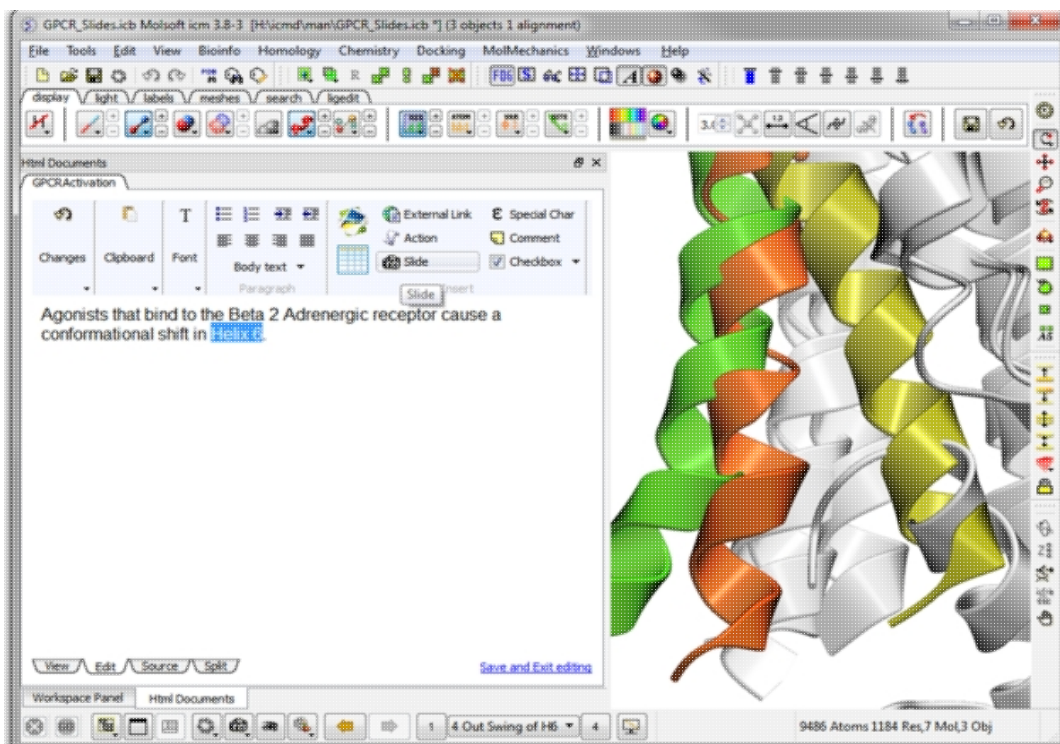

Step 11: Hyperlinks can be made to the slide. Other functions such as adding check boxes, ICM scripts and external links are also available.

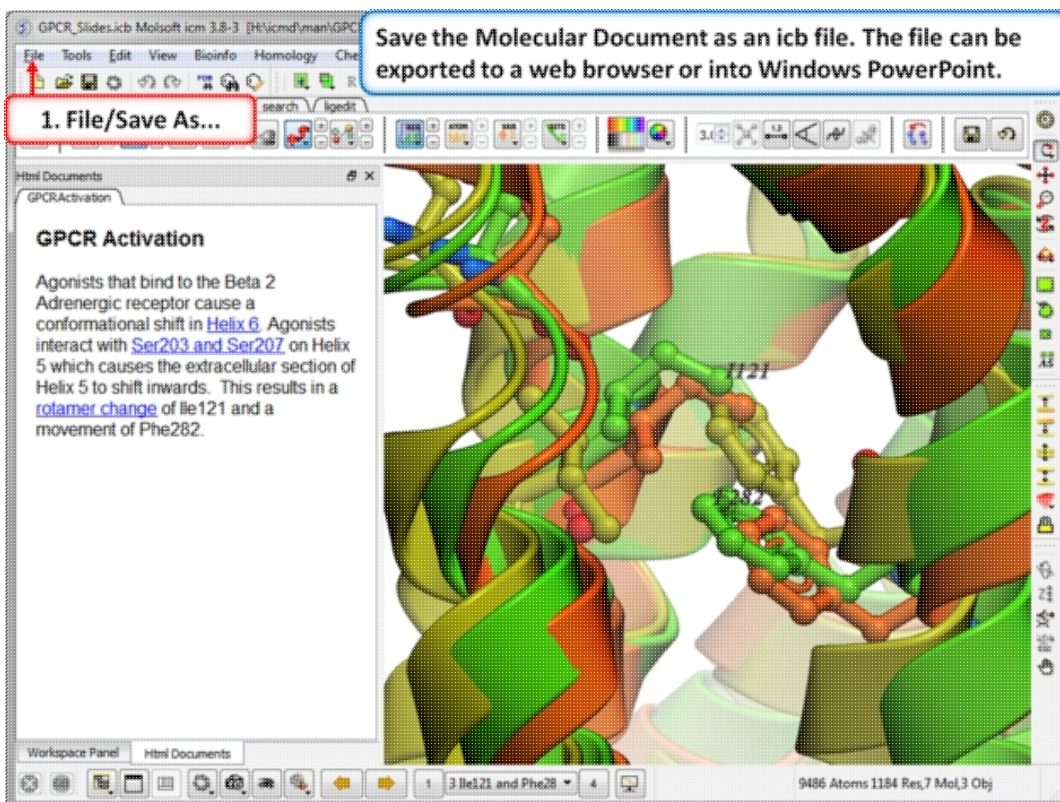

Step 12: Save the molecular document in icb format and view in ICM-Pro or ICM-Browser. You can also export to a web browser or view the fully interactive slides in Windows Powerpoint using a plugin called ActiveICM.

10.3 Protein Structure Tutorials

Introduction

The positioning of the DFG motif in the activation loop of a protein kinase has an effect on the size and properties of the ATP binding pocket. Most kinase inhibitors target the kinase with the DFG inwards to the ATP binding site. Type-II inhibitors target the site where the DFG motif is in the out position which opens up the pocket and provides additional hydrophobic binding sites. Targeting DFG-out conformations can improve inhibitor specificity and slower-off rates.

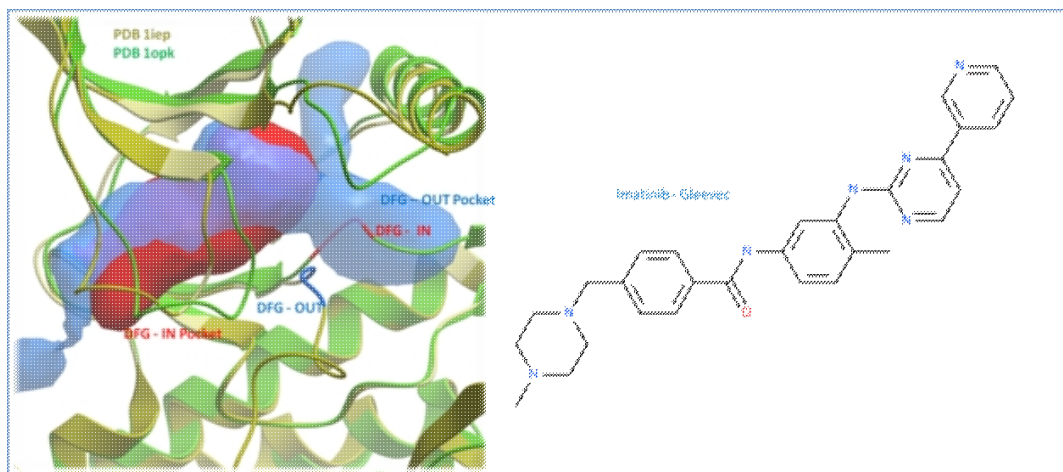

Comparison of the crystal structures of Abl kinase with DFG-IN and DFG-OUT (Left). Imatinib (Gleevec - right) binds to the DFG-OUT conformation.

Tutorial

In this example we will look at two kinase structures and compare their binding pockets. One of the structures is bound to the Type-II inhibitor Imatinib (Gleevec) a drug used to treat Chronic Myelogenous Leukemia. We will use ICM tools to look at the side-chains that interact with the inhibitor and compare the pocket with a DFG-in structure using ICMPocketFinder. Please click on the links provided to learn more about the methods used.

10.3.1 PDB Search

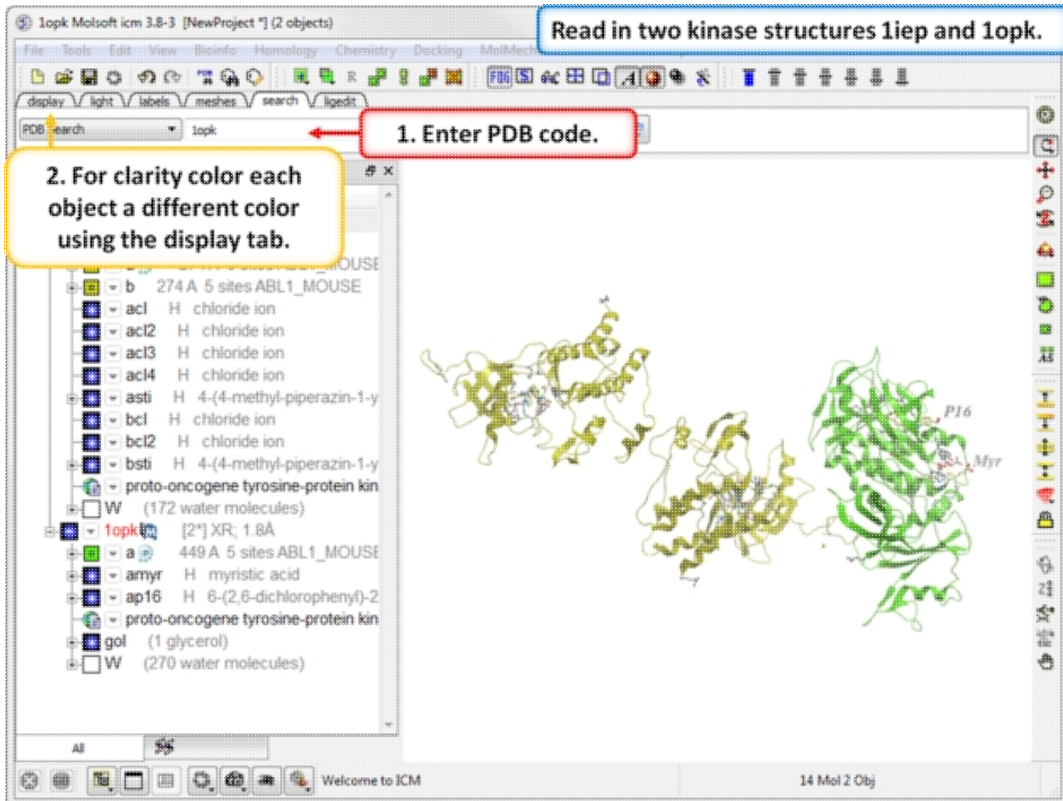

Step 1: Click on the Search Tab and choose "PDB Search" and load the PDBs structures 1iep and 1opk. You can color each object a unique color by clicking on the Display Tab and clicking and holding on the ribbon button and selecting Color by>Object.

10.3.2 Convert PDB to ICM Object

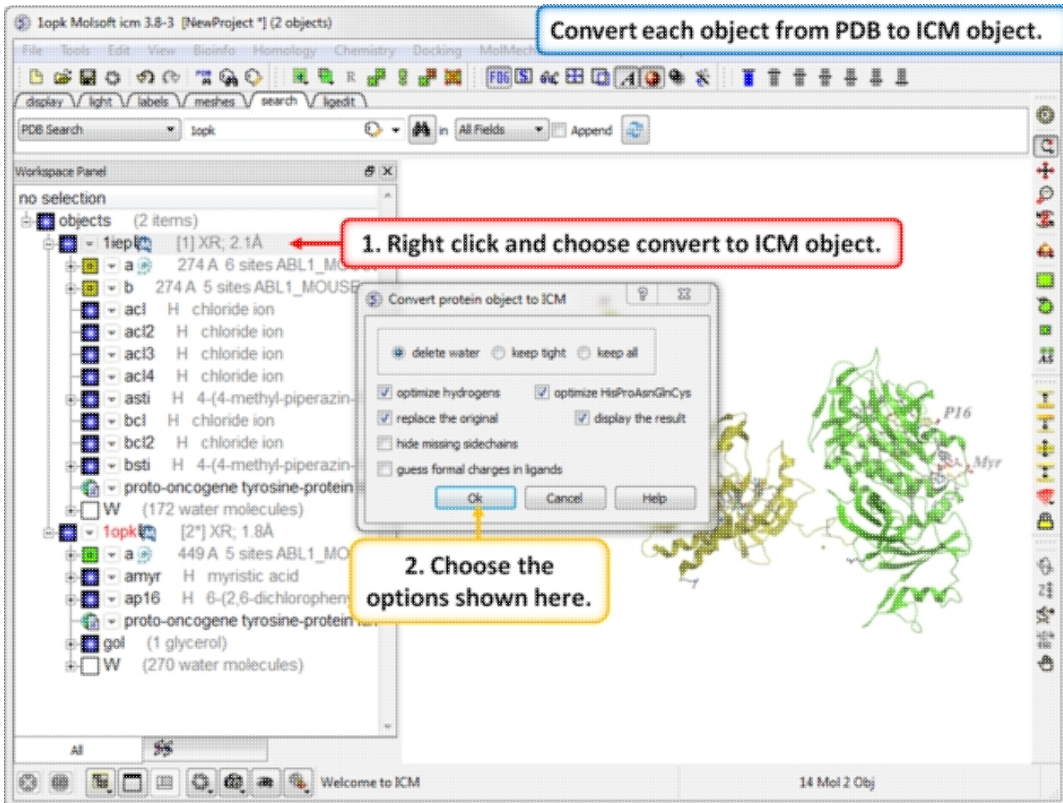

Step 2: Convert each PDB file into an ICM object.

10.3.3 Protein Superposition

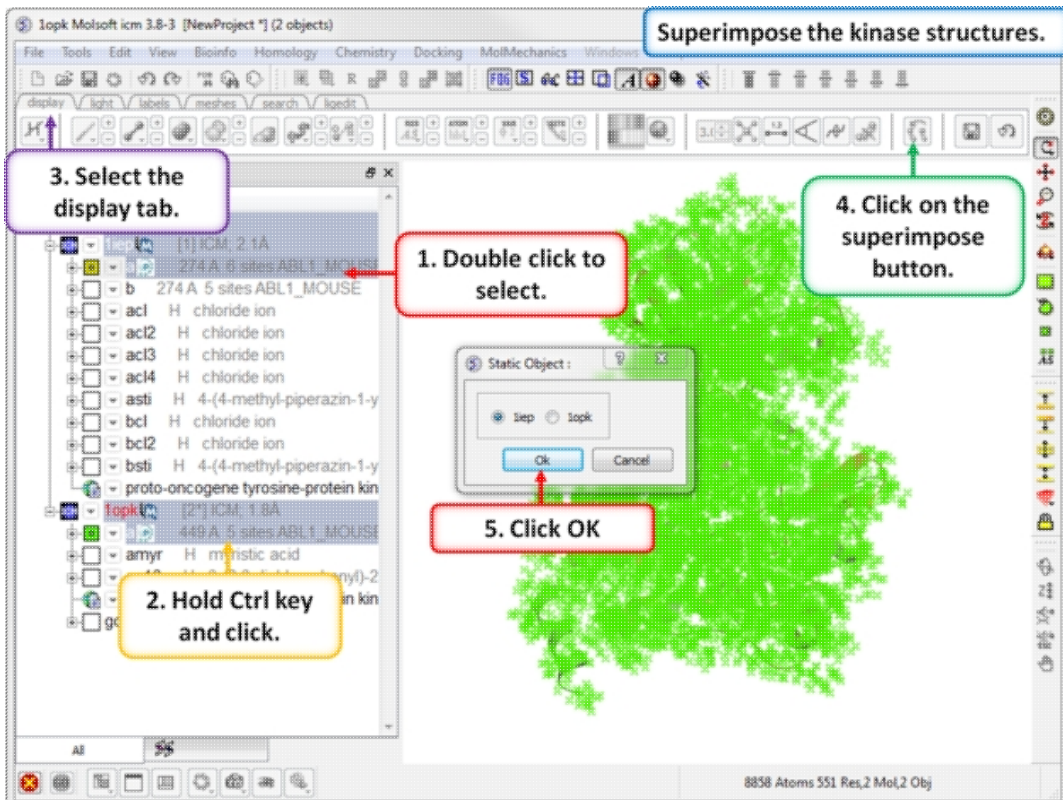

Step 3: Superimpose the two kinase structures.

10.3.4 Protein Structure Analysis

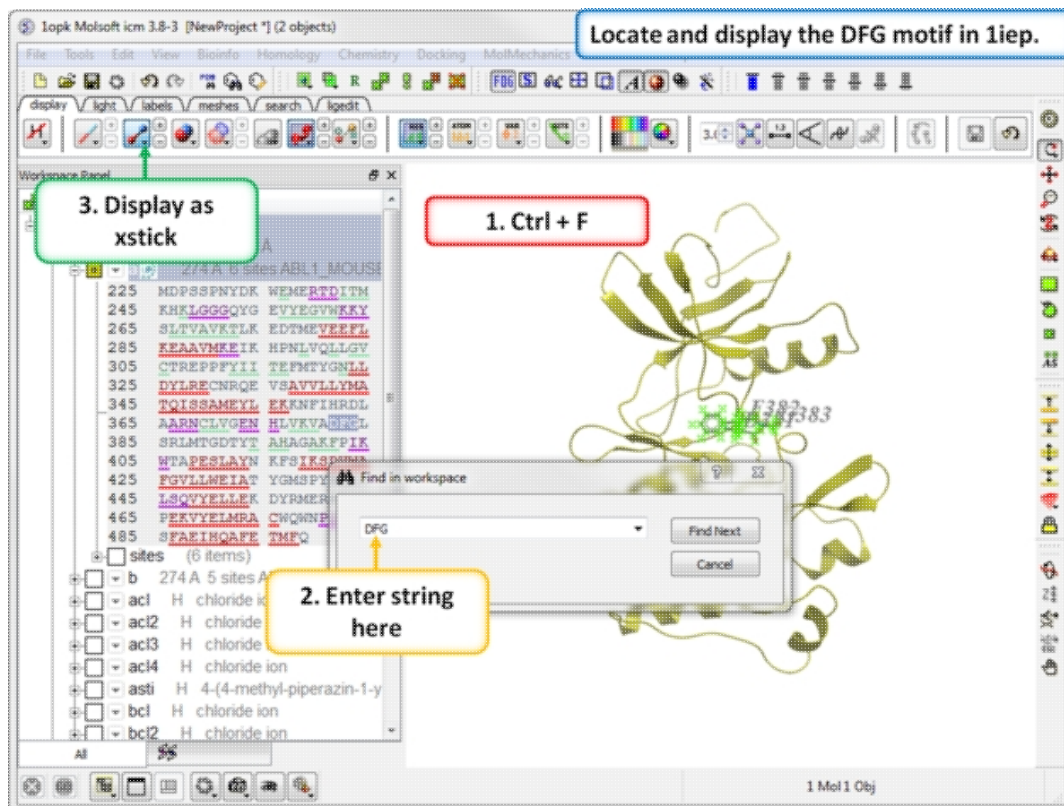

Step 4: Search the "a" subunit of 1iep for the "DFG" motif. You can press Ctrl F and expand the sequence in the ICM workspace. Display the DFG region in xstick.

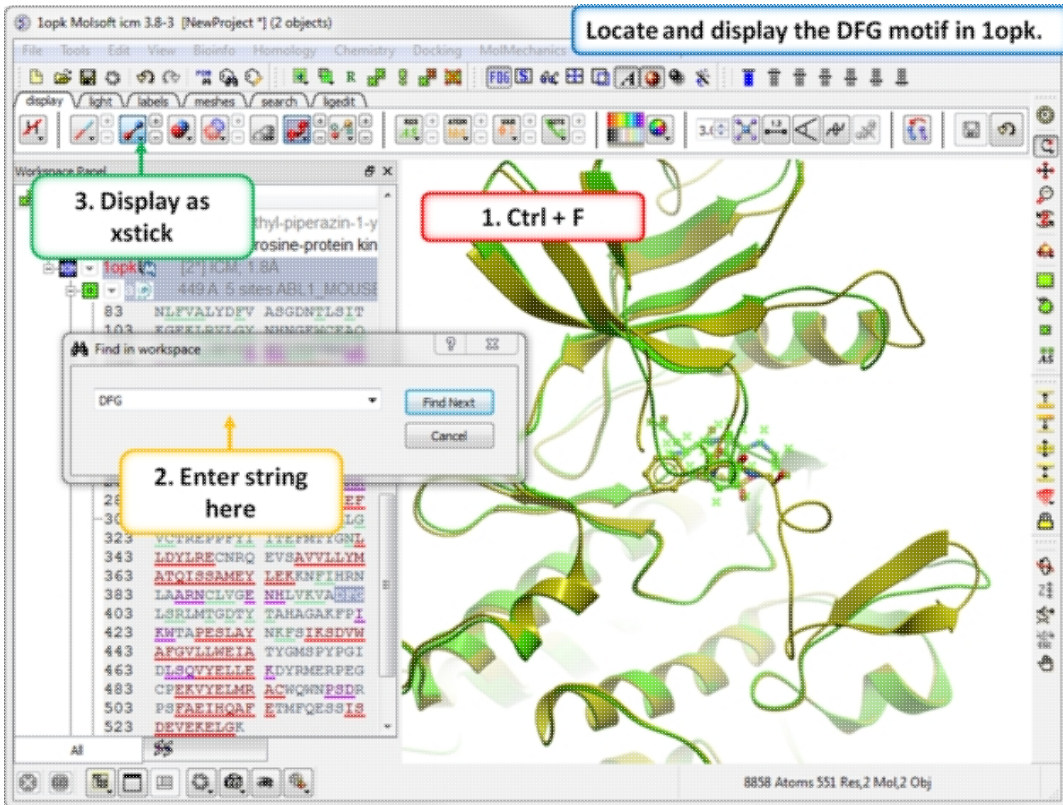

Step 5: Search the "a" subunit of 1opk for the "DFG" motif. You can press Ctrl F and expand the sequence in the ICM workspace. Display the DFG region in xstick.

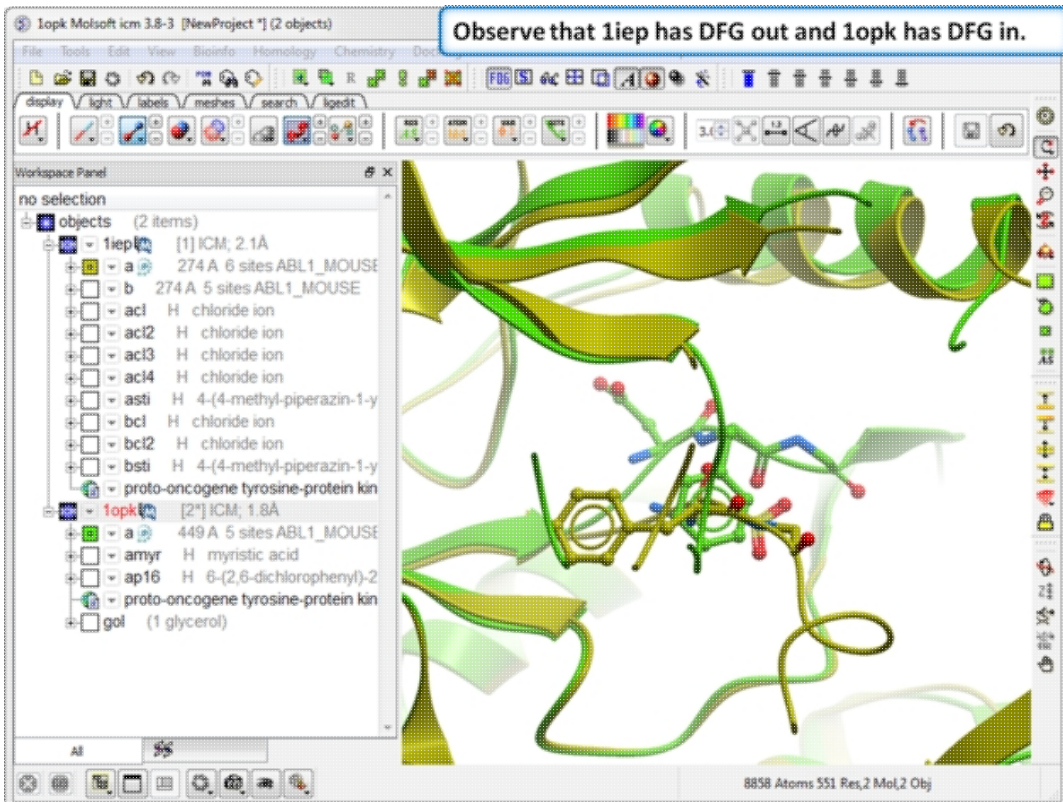

Step 6: Observe the DFG location in both structures.

10.3.5 Contact Areas

10pk Molsoft icm 3.8-3 [NewProject *] (2 objects)

File Tools Edit View BioInfo Homology Chemistry Docking MolMechan

2. Tools/Analysis/Contact Areas.

1. Double click and select Gleevec

3. Click OK.

Calculate pairwise contact ...

Molecular Selection Selection (1 mol)

display

xticks zoom scale 100

Ok Cancel

2 Mol 1 Obj

Step 7: Use Tools/Analysis/Contact Areas to display the contacts with the Gleevec ligand.

10pk Molsoft icm 3.8-3 [NewProject *] (2 objects 1 table)

File Tools Edit View BioInfo Homology Chemistry Docking MolMechan

display light labels meshes search ligedit

1. Click and hold and choose select. Color by Object C.

2. Right click and choose Annotate/Add a Tag.

3. Enter a name for the tag.

Make a tag/field annotation

Field Name DFG_OUT

atom residue molecule object

Ok Cancel

A	ContactArea	ExposedArea	Percent	Closest Atom	Closest DIST
1	1lep.ast/201	541.7	704.2	77_a_1lep.a/thr/sg1	2.082
2	1lep.a/^D381	43.2	104.3	41_a_1lep.ast/sty/o29	2
3	1lep.a/^F382	29.4	156.0	19a_1lep.ast/sty/c9	2.98
4	1lep.a/^T315	27.6	72.6	38a_1lep.ast/sty/c19	2.62

2 Mol 1 Obj

Step 8: Tag the residues surrounding the ligand. Repeat Steps 7 and 8 for the 1opk structure and ligand.

10.3.6 Hydrogen Bond

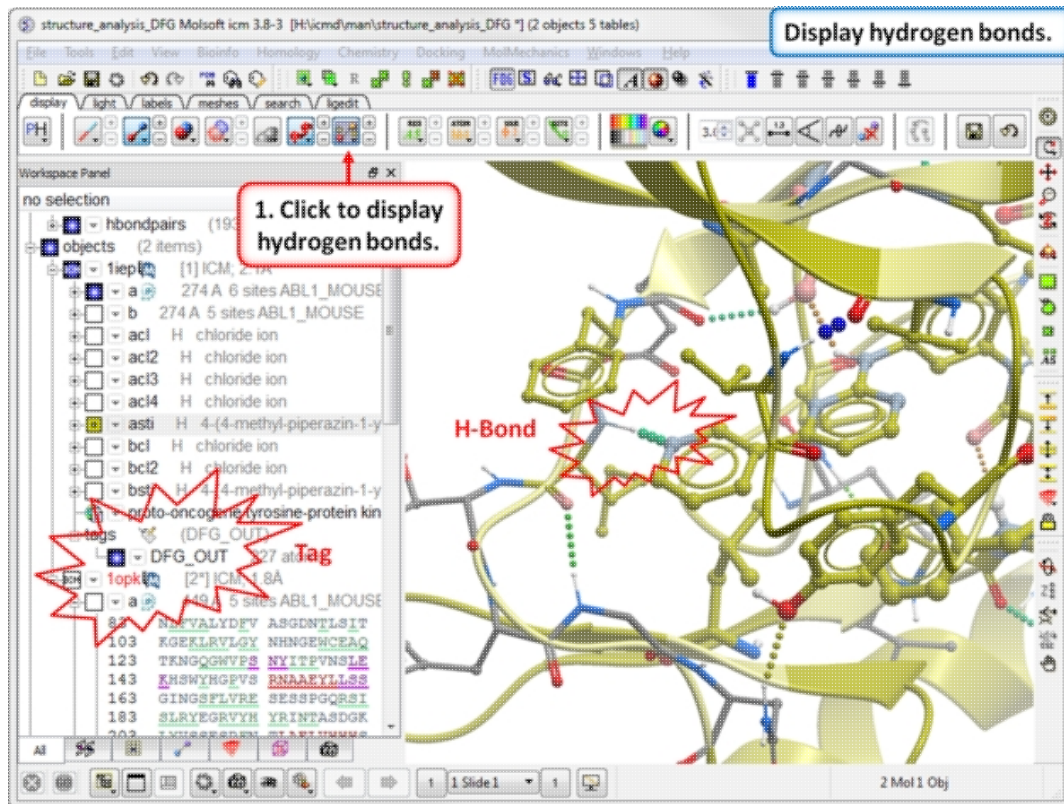

Step 9: Compare the hydrogen bond interaction of the Type I and Type II inhibitors with the hinge region (1iep - residues 317:322) of the kinase.

10.3.7 Pocket Identification

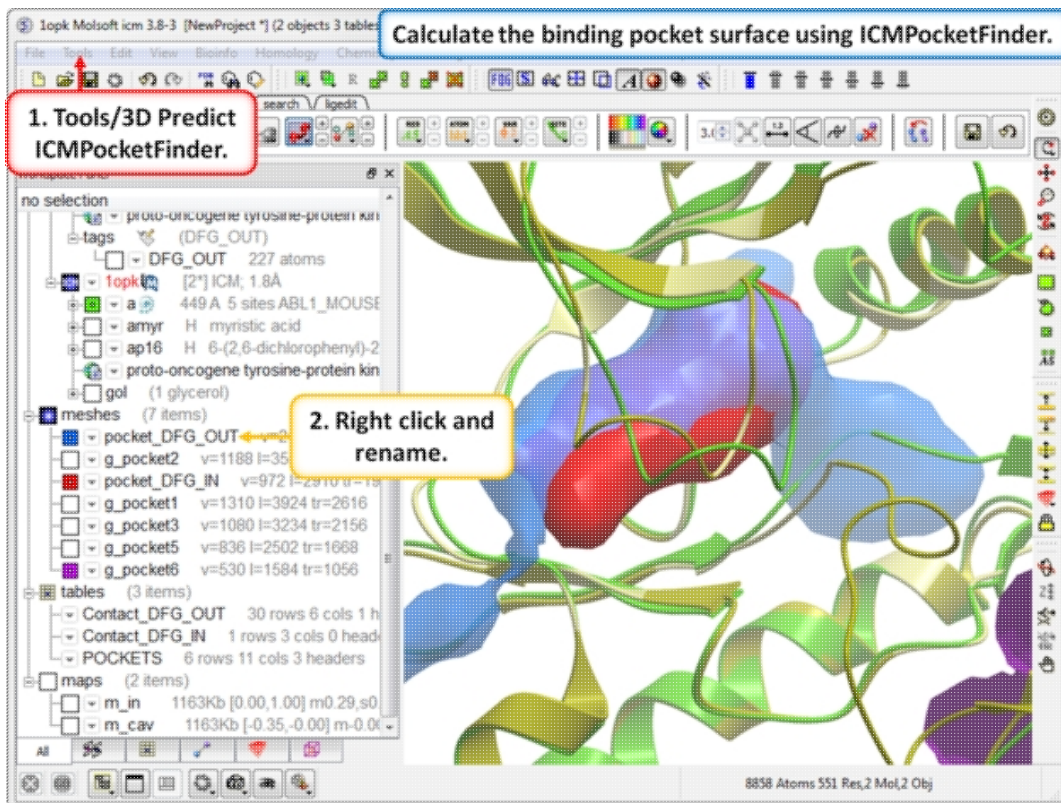

Step 11: Use ICMPocketFinder to compare the pockets of DFG-IN and DFG-OUT. Run ICMPocketFinder for each structure - rename the pocket so as not to overwrite it.

10.3.8 Protein Preparation and Crystallographic Analysis Tutorial

10.3.9 PDB Preparation - Symmetry

Background When inspecting a ligand binding pocket it is important to check that the true pocket is formed by chains which are not explicitly present in a PDB entry. Therefore it is necessary to use **Tools/X-Ray/Crystallographic Neighbor** to find all molecules/subunits or chains involved in the interaction with the ligand. Molecular objects and 3D density maps may contain information about crystallographic symmetry. It consists of the following parameters:

1. Crystallographic group eg. P2121 that determine N (depends on a group) transformations for the atoms in the asymmetric unit.
2. Crystallographic cell parameters A, B, C, Alpha, Beta and Gamma

To generate the coordinates within one cell one needs to apply N transformations and then to generate neighboring cells the content of one cell needs to be translated in space according to the cell position.

Example As an example let us look at Cyclodextrin glycosyltransferase (PDB Code: 1CDG). The problem with docking to this receptor is that the true pocket is formed by chains which are not explicitly present in the PDB entry. Site mb1 includes serine 382. This cannot be predicted just by looking at the structure. Therefore we need to identify symmetry related molecules to this protein.

- Use the PDB search tab to load the crystal structure 1cdg.
- Inspect the ligand binding pocket of **maltose** (mal)

- To identify if there are any other chains involved in the interaction with the ligand select the whole structure in the ICM Workspace.

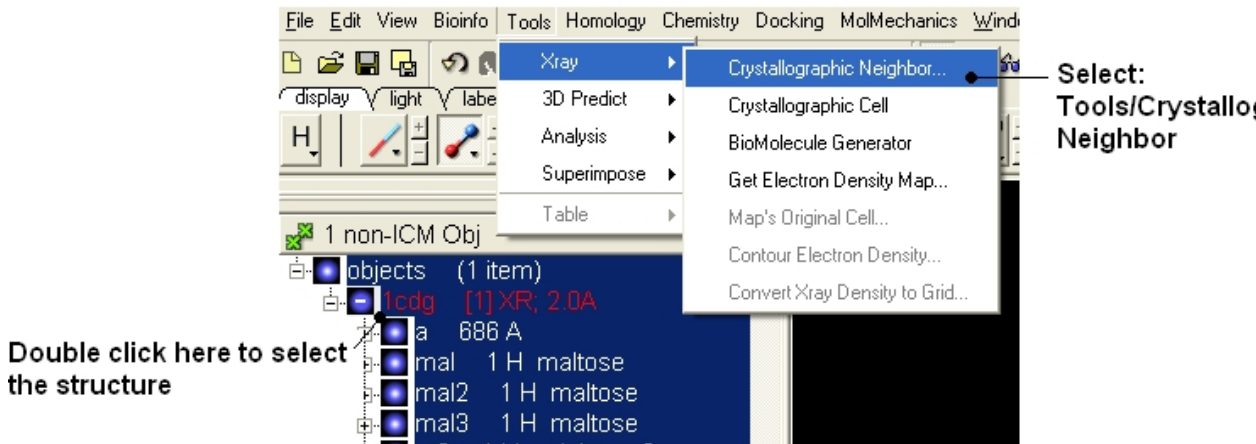

- Tools/Crystallographic Neighbor
- Select a 7Å radius
- Check "create symmetry related molecules" and "display symmetry neighbors".
- Inspect the neighbors surrounding **maltose(mal)**. Each symmetry related subunit can be colored by object by clicking and holding the representation button in the display tab and selecting color-by.

site mb1 includes residue ser 382 for symmetry-related molecule. site mb3 includes the following residues for symmet

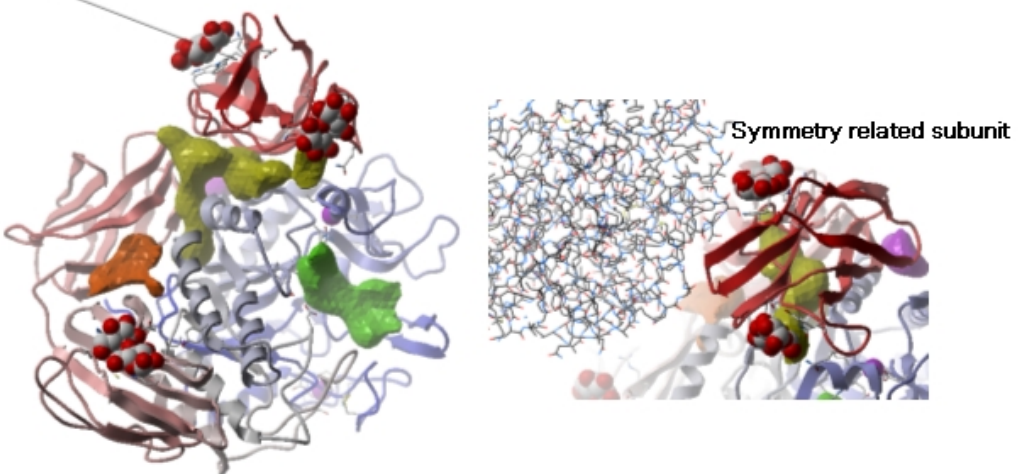

10.3.10 PDB Preparation - Occupancy and B-Factors

Background When preparing a PDB for analysis (eg docking or modeling) it is important to check the reported occupancies and b-factors. The occupancy is a fraction of atomic density at a given center. If there are two equally occupied conformers both will have an occupancy of 0.5 - the normal value is 1 range 0-1. The $\{B\text{-Factor}\}$ is the mean-square displacement of atom from its position in the model - the normal range is 5-50.

One way of visualizing the occupancy and b-factor is by coloring the structure by these values. You can do this by clicking and holding on a representation button in the **display** panel and selecting Color-by.

As an example let us look at the crystal structure 1ATP

- Type in the PDB search tab 1atp and the structure will be displayed in the graphical display.
- Use the ICM workspace to undisplay everything except for the "e" subunit. You can do this by clicking in the blue boxes in the ICM Workspace.
- Display the "e" subunit in wire representation using the wire button in the **display** tab.
- Click and hold on the wire button and select Color-by B-Factor. Regions of high B-factor are colored red.

Click and hold

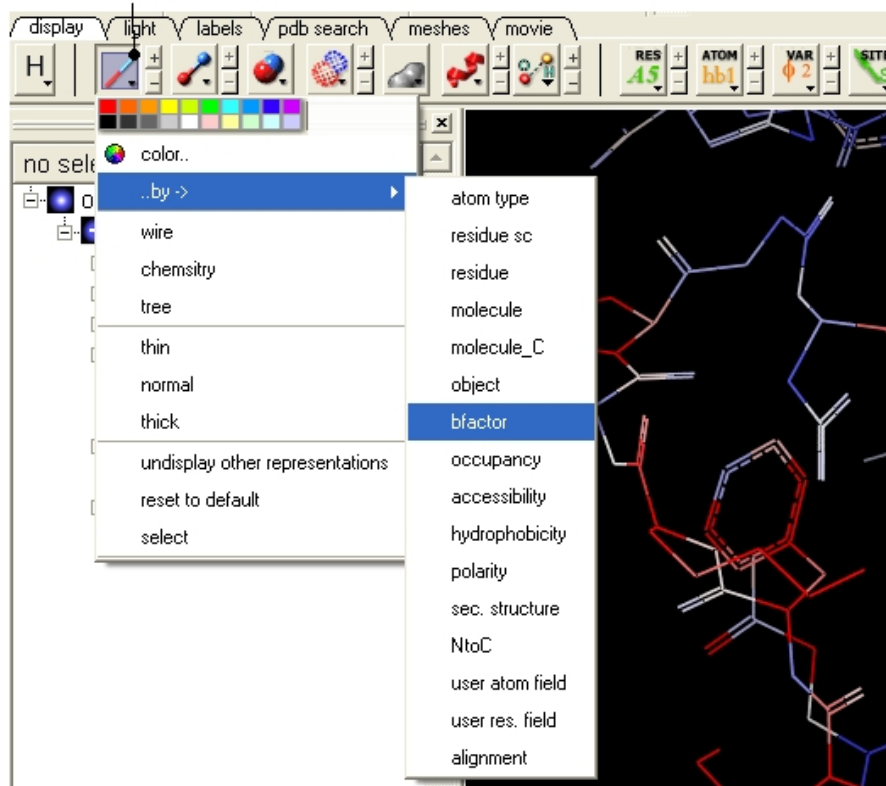

Residues with high B-Factor are colored red

10.3.11 PDB Preparation - Residue Alternative Orientation

For some very high resolution structures two alternative conformations for a residue are provided. Therefore for docking you need to decide to use one conformation of the residue or generate several separate docking models. This could be performed using multiple receptor conformation docking.

Here is an example of alternative residue orientations found in a crystal structure of a Fatty Acid Binding protein in complex with stearic acid.

Load and display the PDB structure 1HMT.

1. PDB search 1HMT

2. Undisplay xstick, residue and variable labels

```

[com/daZ] undisplay window
[com/daZ] _m_molViewProject = ""
[com/daZ] generalViewProject "PDB Search" "1hmt"
[com/daZ] undisplay xstick Res("*/100)
[com/daZ] undisplay residue label Res("*/100)
[com/daZ] undisplay site Res("*/100)
[com/daZ]

```

Display alternative conformations for V32 and T36.

1. Click here to expand residue level

2. Hold the control key and click and drag over V32 and T36

4. Click center button

```

[com/daZ] set stick residue label size=15
[com/daZ] set stick residue label size=15
[com/daZ] set stick residue label size=15
[com/daZ] set stick residue label size=15
[com/daZ] set stick residue label size=15
[com/daZ] set stick residue label size=15
[com/daZ]

```

10.3.12 Biomolecule Generator

Objective

Here we will investigate the biological environment of a virus protein .
PDB code 1DWN.

Background

It is very useful to know how a protein from the PDB may look in a biological environment. The PDB entries solved by X-ray crystallography and deposited in the PDB contain the information about the crystal structure rather than the biologically relevant structure. For example, for a viral capsid only one instance of capsid protein complex will be deposited and only one or two molecules of haemoglobin that is a tetramer in solution maybe deposited. In some other cases the asymmetric unit may contain more than one copy of a biologically monomeric protein. ICM reads the biological unit information and has a tool to generate a biological unit. Not every PDB entry has the biological unit information.

Instructions

- Read and load the PDB file 1DWN
- Tools/Xray/Biomolecule Generator
- Tick the makeAllBiomolecules box (Warning this may take a few minutes to generate)
- The generated molecules will be listed in the ICM Workspace. Each one can be selected and displayed. The biomolecule is shown below.

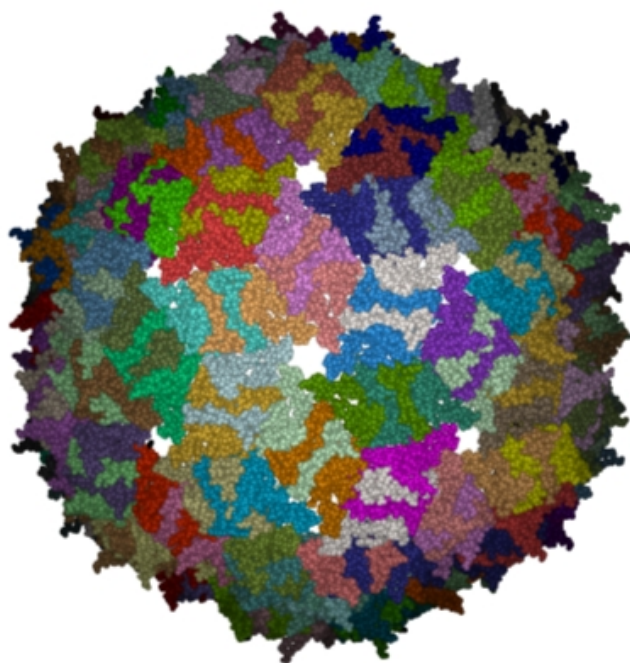

NOTE: Please note that right clicking on a PDB file in the ICM Workspace will tell you whether there is any **Biomolecule** information available for the structure. If this information is not present then the option will be greyed out.

Manual References (Web Links)

Biomolecule Generator

10.4 Cheminformatics Tutorials

10.4.1 Chemical Draw and Spreadsheet Tutorial

Background

Cyclooxygenase 2 (COX-2) inhibitors can target inflammation and pain and are non-steroidal anti-inflammatory (NSAID) drugs. Some of the COX-2 inhibitor drugs have an interesting history because some of them cause a significant increase in heart attacks and stroke in patients. Probably the best known COX-2 inhibitor is Merck's drug Vioxx which was voluntarily removed from the market in 2004. In this example we are going to build a small database of COX-2 inhibitor drugs, learn how to import COX-2 inhibitor data from ChEMBL and how to manipulate chemical spreadsheets in ICM.

Tutorial

Sketch the COX-2 inhibitor Celebrex

1. Click on the Molecular Editor button

2. Use the bond and atom buttons to sketch

3. Monitor Properties

Name	Value
1 Formula	C17H14F3N3
2 Smiles	O=S(=O)(C(C=C
3 SUPAC	4-(5-p-tolyl-3-(
4 InChI	InChI=1S/C17H
5 InChIKey	R2EKVGIVFLEC
6 MolWeight	381.0799
7 HBA	4
8 HBD	2
9 RotB	4
10 Drug likeness	-1.03104
11 MolArea	354.755
12 MolHf	-146.26
13 MolLogP	3.96221
14 MolLogS	-6.13679
15 MolPSA	63.6646
16 Volume	313.115
17 Bad Groups	
18 Groups	Phenyl Pyrazole Halo Sulfonamide

Step 1: Sketch Celebrex. The first COX-2 drug we are going to draw is Celebrex (Celecoxib) from Pfizer. Click on the Molecular Editor button and use the bond and atoms button to sketch Celebra (shown). Note you can monitor key chemical properties of the molecule as you sketch it.

Add the name of the drug and export to chemical spreadsheet.

1. Add Name
"Celebrex"

2. Export to
Chemical
Spreadsheet

3. Enter as shown

Name	Value
1 Formula	C17H14F3N3
2 Smiles	O=S(=O)(C(C=C
3 IUPAC	4-(5-p-tolyl-3-(
4 InChI	InChI=1S/C17H
5 InChIKey	RZEKQVHVFLEC
MolWeight	381.0799
HBA	4
HBD	2
RotB	4
DrugLikeness	-1.83104
MolArea	354.755
MolHf	-146.26
13 MolLogP	3.96221
14 MolLogS	-6.15579
15 MolPSA	63.6646
16 Volume	313.115
17 Bad Groups	
18 Groups	Phenyl Pyrazole Halo Sulfonamide

Step 2: Export to Chemical Spreadsheet. Rename the chemical to its brand name (Celebrex) and export to a chemical spreadsheet.

Observe new chemical spreadsheet.

Cox2_Inhibitors	
mol	Molecule Name Celebrex

Step 3: Observe Chemical Spreadsheet. You should now have one chemical in your Cox2_Inhibitors spreadsheet.

The screenshot shows the Molsoft ICM 3.8-1 interface. A spreadsheet window is open with two rows. Row 1 contains a chemical structure of Celebrex. Row 2 is empty. A red callout box points to the right-click action on row 2, labeled "1. Right click 'Insert New Row'". A yellow callout box points to the double-click action on row 2, labeled "2. Double click and sketch Vioxx shown (right)". A green callout box points to the ICM Molecule Editor window, labeled "3. Close editor and the chemical will be added to the spreadsheet". The ICM Molecule Editor window shows the chemical structure of Vioxx being sketched. A blue callout box at the top right says "Add a new row to the chemical spreadsheet and add Vioxx."

Step 4: Add a new row. Add a new row to the spreadsheet and then sketch the Vioxx (Rofecoxib) drug (shown).

The screenshot shows the Molsoft ICM 3.8-1 interface with the chemical spreadsheet updated. The spreadsheet window is titled "Cox2_inhibitors" and contains two rows. Row 1 shows the chemical structure of Celebrex and the name "Celebrex". Row 2 shows the chemical structure of Vioxx and the name "Vioxx". A blue callout box at the top right says "Now you should have two chemicals in your spreadsheet."

Step 5: Observe Chemical Spreadsheet. Now you should have 2 chemicals in your spreadsheet.

1. Click on the Ligand Editor button

2. Edit/Add Smiles

3. Paste SMILES string

4. Export chemical to spreadsheet

Add the COX-2 inhibitor Bextra to the spreadsheet using SMILES string.

	Value
1 Formula	C16 H14 N2 O3
2 Smiles	O=S(=O)(N)C3=CC=C(C=C3)C4=CC=C(C=C4)N5C=CC=C5
3 EUPAC	4-(5-methyl-3-pyridin-2-ylsulfamoyl)benzoic acid
4 InChI	InChI=1S/C16H14N2O3
5 InChIKey	LNPTQAFDNC
6 MolWeight	314.0725
7 HBA	5
8 HBD	2
9 RotB	3
10 DrugLikeness	0.0330088
11 MolArea	316.735
12 MolChf	-14.1406
13 MolLogP	3.06632
14 MolLogS	-4.98608
15 MolPSA	72.5302
16 Volume	273.547
17 Bad Groups	
18 Groups	Phenyl Isoxazole Sulfonamide

Step 6: Using SMILES. A convenient way to import chemical data is by using SMILES. Bextra (Valdecoxib) is a COX-2 inhibitor that was removed from the market by Pfizer in 2005 due to concerns of an increased risk of heart attack and stroke. Bextra's SMILES string is:
O=S(=O)(N)c3ccc(c2c(oc2c1ccccc1)C)cc3

1. Click and start typing "Nabumetone"

2. Export to Chemical Spreadsheet

Use the chemical dictionary to read in the drug Relafen (Nabumetone).

	Value
1 Formula	C15 H16 O2
2 Smiles	CC(=O)CC(C)C1=CC=C(C=C1)C2=CC=C(C=C2)OC
3 EUPAC	4-(8-methoxy-2-naphthyl)butanoic acid
4 InChI	InChI=1S/C15H16O2
5 InChIKey	BLXXJMDKXQ
6 MolWeight	228.1150
7 HBA	2
8 HBD	0
9 RotB	4
10 DrugLikeness	-6.746927
11 MolArea	276.562
12 MolChf	-51.083
13 MolLogP	3.82632
14 MolLogS	-4.57031
15 MolPSA	20.8457
16 Volume	240.325
17 Bad Groups	
18 Groups	Ketone (Carbor Ether)

Step 7: Using the Chemical Dictionary. Another convenient way to import chemical data is to use the in built chemical dictionary. Relafen is Nabumetone is an NSAID that is rapidly metabolized in the liver to a major active metabolite, 6-methoxy-2-naphthyl acetic acid.

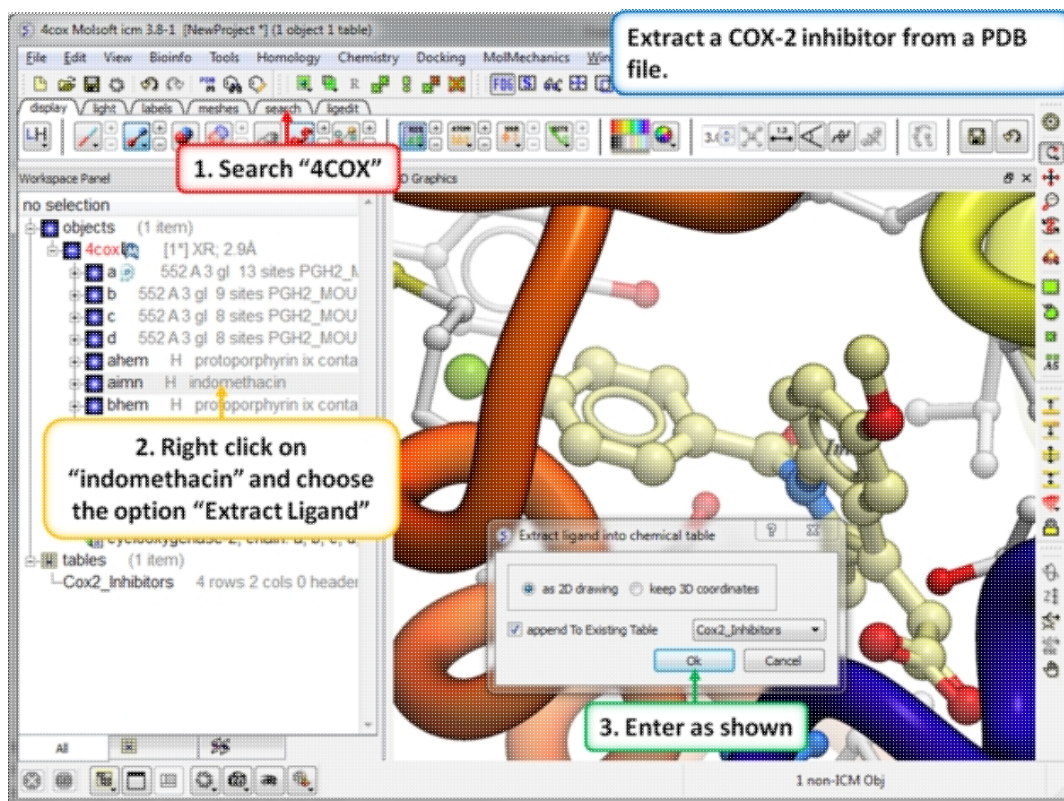

Step 8: Extracting Chemicals from the PDB. You can extract a chemical from a PDB file into a chemical spreadsheet by right clicking on the ligand in the ICM workspace and choosing the option "Extract Ligand".

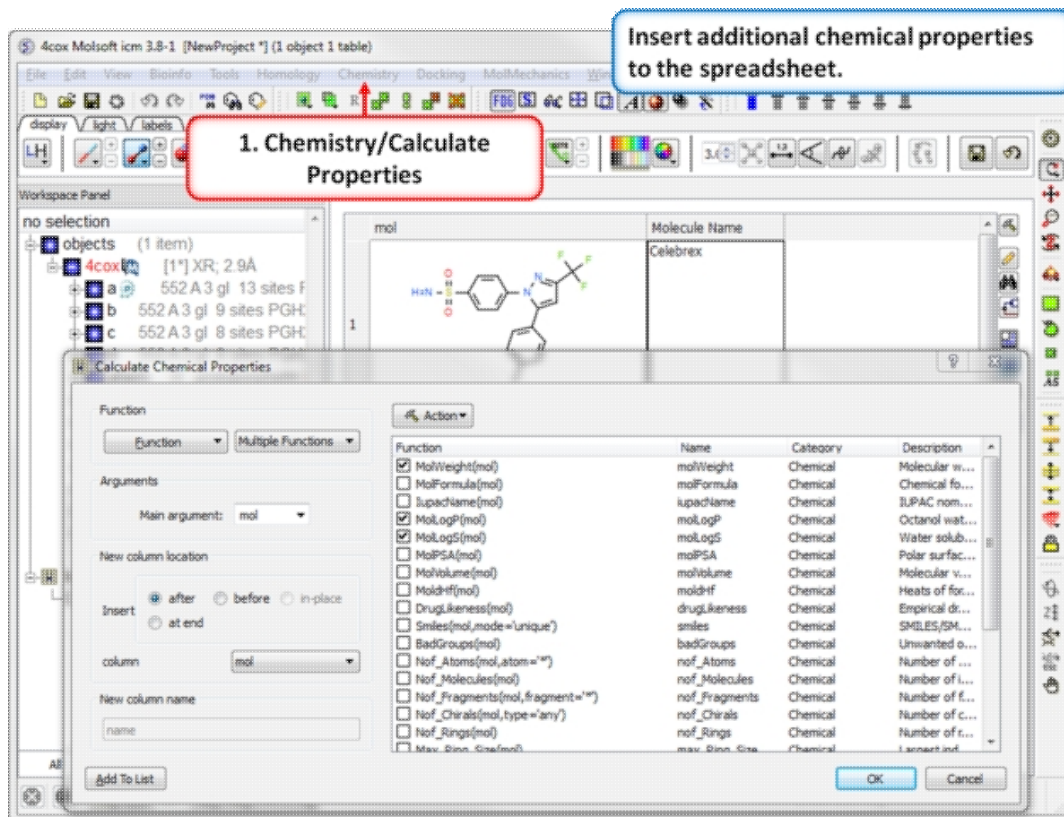

Step 9: Calculate Properties and Insert Columns. Use the Chemistry/Calculate Properties to calculate properties (e.g. logP, logS, MW) for the drugs in the spreadsheet.

In this example we will import more COX-2 inhibitor information from ChEMBL. ChEMBL is a database of bioactive drug-like small molecules curated from the primary scientific literature.

Note: In version 3.8-4 and higher you can search ChEMBL directly from the GUI interface.

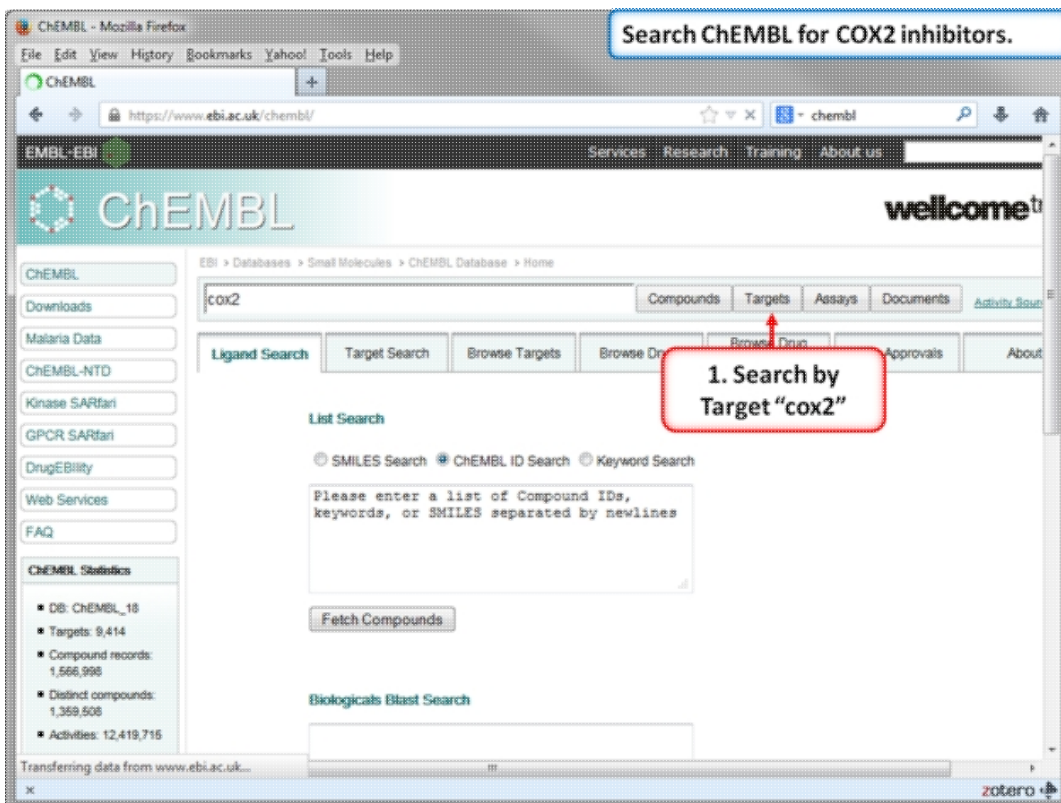

Step 10: Search for COX-2 in ChEMBL.

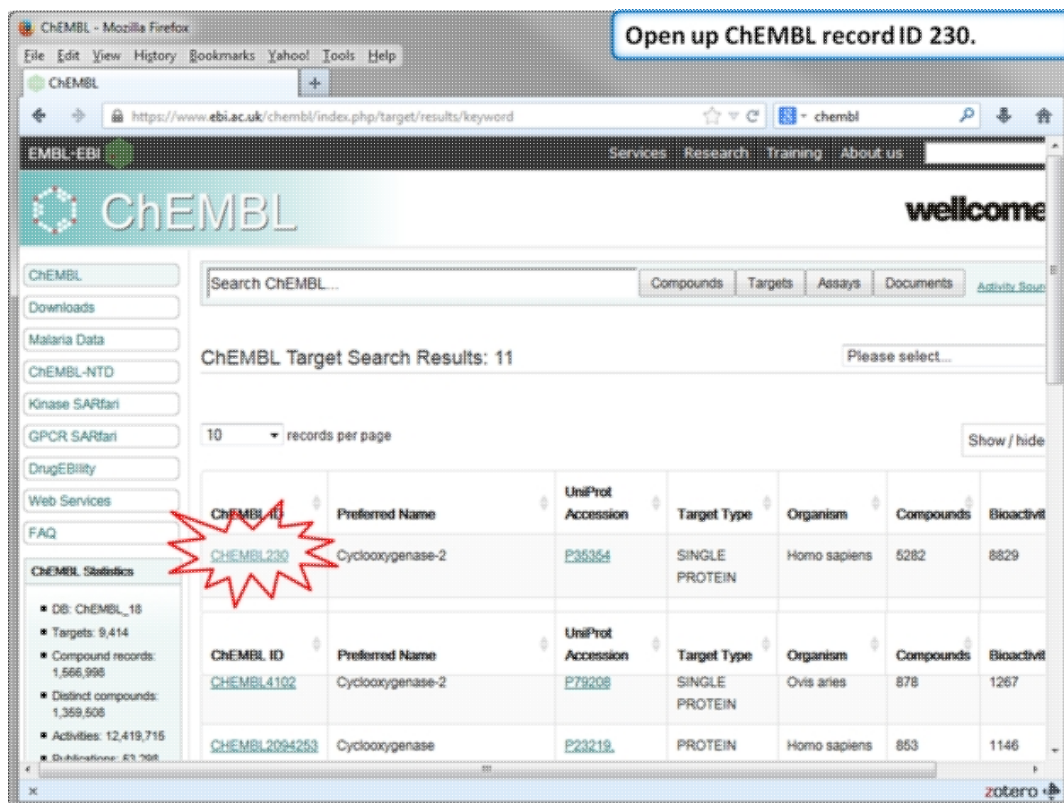

Step 11: Select Human COX-2 entry.

CHEMBL230 Target Report Card - Mozilla Firefox

File Edit View History Bookmarks Yahoo! Tools Help

CHEMBL230 Target Report Card

https://www.ebi.ac.uk/chembl/target/inspect/CHEMBL230

chembl

CHEMBL624	ETOUOLAC	Cyclooxygenase-2 inhibitor	PubMed
CHEMBL599	MELOXICAM	Cyclooxygenase-2 inhibitor	PubMed
CHEMBL1070	NABUMETONE	Cyclooxygenase-2 inhibitor	DailyMed
CHEMBL122	ROFECOXIB	Cyclooxygenase-2 inhibitor	EDA
CHEMBL865	VALDECOXIB	Cyclooxygenase-2 inhibitor	DailyMed

Target Associated Bioactivities

ChEMBL Activity Types for Target CHEMBL230

Total: 8829

Target Associated Assays

ChEMBL Assays for Target CHEMBL230

Transferring data from www.ebi.ac.uk...

Binding (626)

zotero

Open up the records containing IC50 data

Step 12: Select chemicals annotated with Ki values.

CHEMBL - Mozilla Firefox

File Edit View History Bookmarks Yahoo! Tools Help

ChEMBL

https://www.ebi.ac.uk/chembl/bioactivity/results/1/cmpd_chemblid/asc/tab/display

Services Research Training About us

wellcome trust

Compounds Targets Assays Documents Activity Source Filter

s: 878

Please select...
Please select...
Download All Bioactivity Data (Tab-delimited)
Download All Bioactivity Data (XLS)

Show / hide columns

Relation	Standard Value	Standard Units	Assay Type	Description	Assay Src Description	Assay Organism	Target Type	Target Name	Target Organism	Reference
			B	DRUGMATRIX: Cyclooxygenase COX-2 enzyme inhibition (substrate: Arachidonic acid)	DrugMatrix in vitro pharmacology assays		SINGLE PROTEIN	Cyclooxygenase-2	Homo sapiens	CHEMBL1909046
			B	DRUGMATRIX:	DrugMatrix in		SINGLE	Cyclooxygenase-2	Homo	CHEMBL1909046

zotero

Download the data in XLS format and then open in Excel and save in comma separated value form (.csv)

Step 13: Download in XLS format.

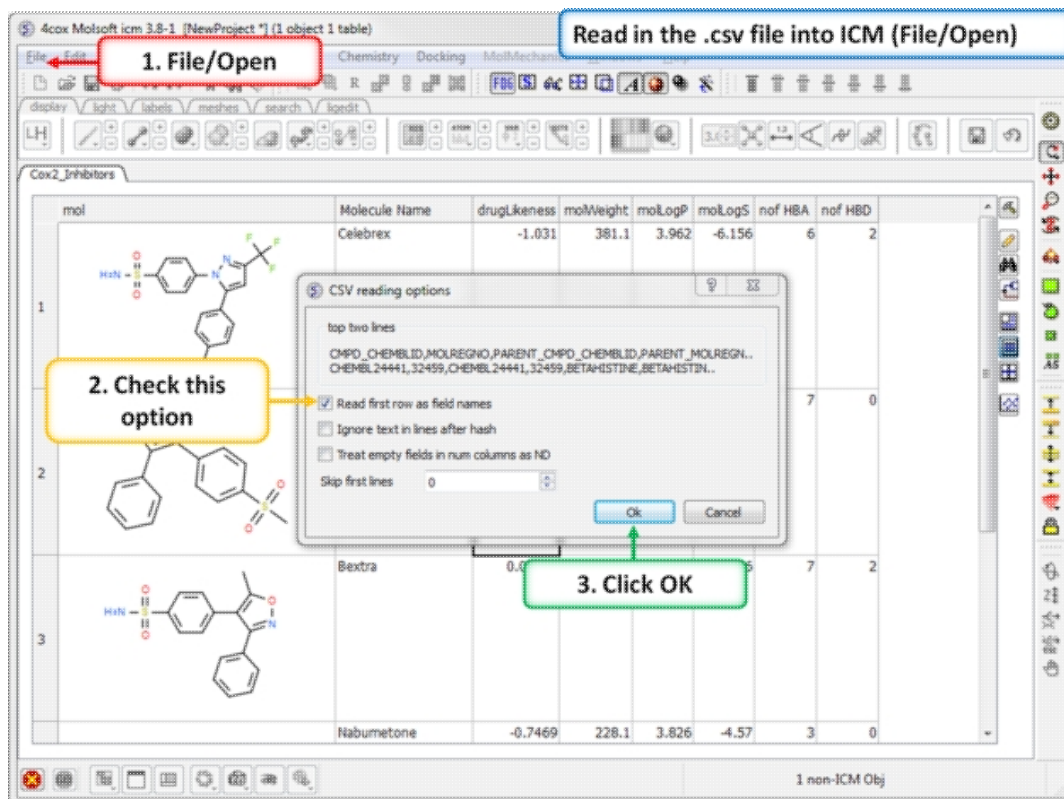

Step 14: Convert to csv format. Open the .xls file in Excel and save in comma separated value format (.csv). Read in the .csv file into ICM using File/Open. Rename the table Cox2_inhibitors - right click on table header tab and choose rename.

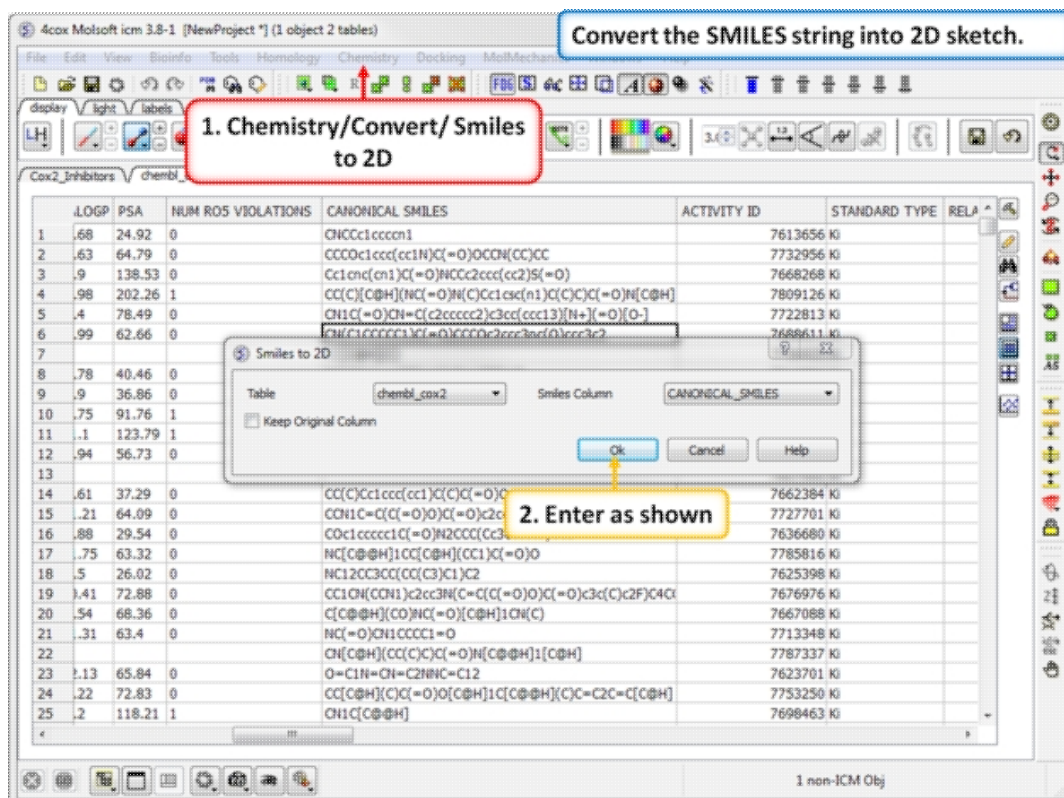

Step 15: SMILES to 2D. Convert the SMILES column into 2D. This may take a little bit of time because the table is quite large. We can use this

table in the following tutorial.

10.4.2 Chemical Searching

Background

This tutorial follows on from the previous tutorial where we made a database of COX-2 inhibitors (Cox2_Inhibitors) and read in a chemical spreadsheet containing IC50 data from ChEMBL (chembl_cox2). In this tutorial we will perform chemical spreadsheet comparison and explore some of the chemical search options inside ICM.

Tutorial

Let us compare our small spreadsheet of COX-2 drugs with the larger set of inhibitors from ChEMBL.

1. Chemistry/Compare two sets

Compare Two Sets

First Table: Cox2_inhibitors Second Table: chembl_cox2

exact similarity

Distance: 0.5

Select Matching Records Show Only Different Records

Hint: Double-click on the tab of the second table to see them side by side

OK Cancel Help

2. Enter as shown

CMPD CHEMBLID	mol	MOLREGNO	PARENT CMPD CHEMBLID	PARENT MOLREGNO	MOL PREI
CHEMBL56337	<chem>C1=CC=C(C=C1)C(=O)N</chem>	88882	CHEMBL56337	88882	EPALRES
CHEMBL175	<chem>C1=CC=C(C=C1)C(=O)N</chem>	317909	DEXBUPR		
CHEMBL86304	<chem>C1=CC=C(C=C1)C(=O)NCCN2CCOCC2</chem>	139099	CHEMBL86304	139099	MOCLOBE

Step 1: Similarity search - compare two spreadsheets. Here we can compare our two chemical spreadsheets using Chemistry/Compare two sets using a similarity search.

Let us make a new spreadsheet from the comparison hits. Selected compounds will be highlighted in blue.

1. Right click and choose Copy rows to ICM Table

2. Enter a new table name for the similar compounds

CMPD CHEMBLID	mol	MOLREGNO	PARENT CMPD CHEMBLID	PARENT MOLREGNO	MOL PRE
CHEMBL56337	<chem>Cc1nc2c(c1)ccc2C(=O)N</chem>	88882	CHEMBL56337	88882	EPALRES
CHEMBL175	<chem>CC(C)C(C)C1=CC=C(C=C1)C(=O)C</chem>	139099	CHEMBL86304	139099	MOOLOBE
CHEMBL86304	<chem>CC(C)C(C)C1=CC=C(C=C1)C(=O)C</chem>	139099	CHEMBL86304	139099	MOOLOBE

Step 2: Output the similar chemicals to a new spreadsheet. Similar compounds are selected (shaded blue) we can extract them to a new table using the right click menu.

Save the spreadsheets in SDF format and delete Cox2_Inhibitors and similar_0_5

1. Right click "Save As" .sdf.

mol	Molecule Name	drugLikeness	molWeight	molLogP	molLogS	nof HBA	nof HBD
1	<chem>Cc1nc2c(c1)ccc2C(=O)N</chem>	-1.031	381.1	3.962	-6.156	6	2
2	Vioxx	-0.7455	314.1	2.205	-4.957	7	0
3	Bextra	0.03301	314.1	3.066	-4.986	7	2
	Nabumetone	-0.7469	228.1	3.826	-4.57	3	0

Step 3: Save as SDF. You can save any chemical spreadsheet by right clicking on the table header tab.

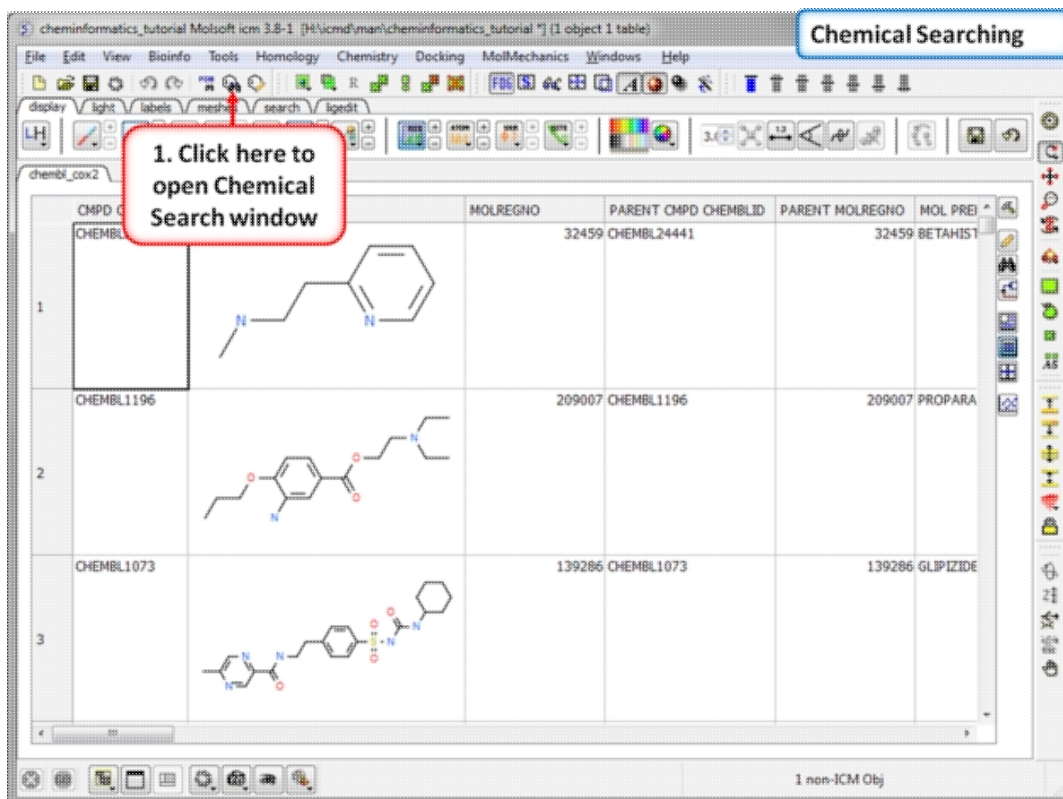

Step 4: Chemical Searching. Now let us explore the chemical search options.

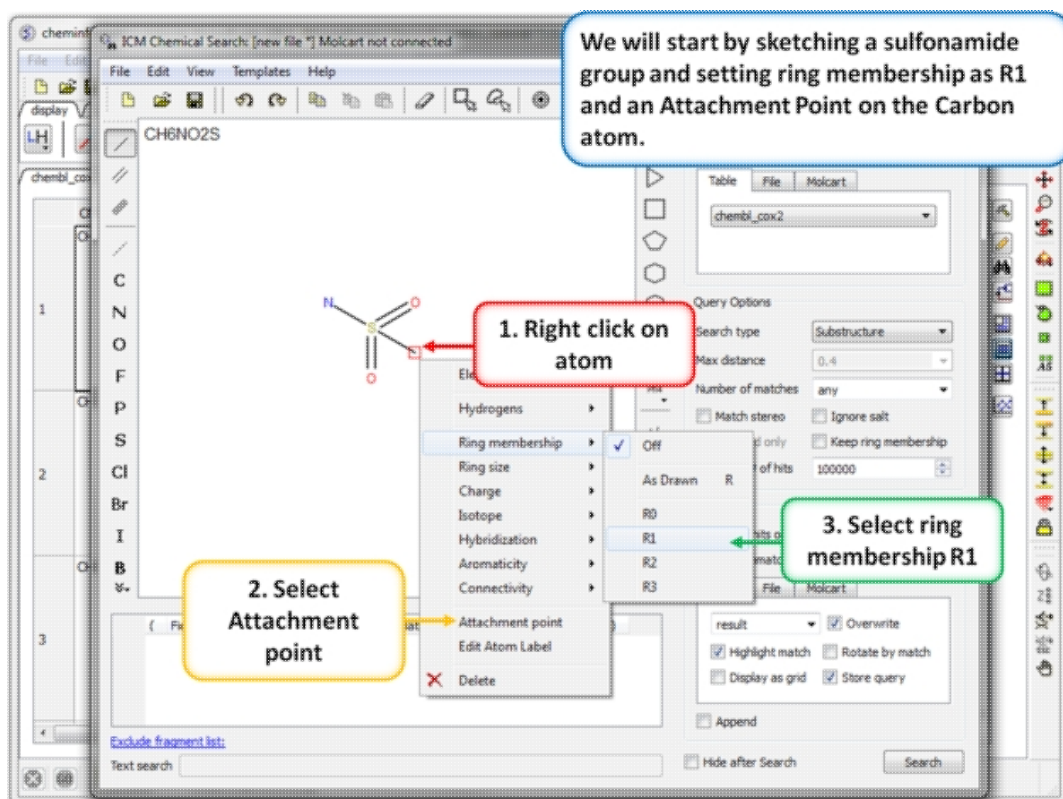

Step 5: Sketch search query. We will start by sketching a sulfonamide group and setting ring membership as R1 and an Attachment Point on the Carbon atom.

The screenshot shows the ICM Chemical Search interface. A chemical sketch of a sulfonamide group is in the center. The right-hand panel is configured as follows:

- Query Input:** A red callout points to the input field containing the sketch, labeled "1. Our query is the sketch".
- Data Source:** A yellow callout points to the dropdown menu set to "chembl_cox2", labeled "2. Table to be searched".
- Search Type:** A green callout points to the "Substructure" dropdown, labeled "3. Select substructure search".
- Results:** A purple callout points to the "result" dropdown in the results section, labeled "4. Results will return to a new table called 'result'".
- Action:** A blue callout points to the "Search" button, labeled "5. Click Search".

A blue callout at the top right says "Your query should look like this." pointing to the query input field.

Step 6: Chemical search window. Choose the options as shown in the screenshot and press search.

The screenshot shows the search results window. A table displays the following results:

CMPD	CHEMBLID	mol	MOLREGNO
1	CHEMBL21		
2	CHEMBL20		1125 CHEI
3	CHEMBL437		2095 CHEI

A blue callout box on the right says: "Results are shown with the query highlighted in green. We are finding chemicals with sulfonamide linked between two substituents e.g Phenyl-Sulfonamide-Thiazole shown - let us filter these out (next step)." A red starburst is drawn over the third result (CHEMBL437).

Step 7: Search query results. The results will be displayed in a table as shown.

By changing the connectivity of the Nitrogen we can find only terminal sulfonamide groups similar to the drug Celebrex.

1. Right click on the Nitrogen atom and choose Connectivity "As Drawn"

Step 8: Query filter - connectivity. By changing the connectivity of the Nitrogen we can find only terminal sulfonamide groups similar to the drug Celebrex.

By changing the connectivity of the Nitrogen we can find only terminal sulfonamide groups similar to the drug Celebrex.

CMPD	CHEMBLID	mol	MOLREGNO	PAR
	CHEMBL406		racemic	619 CHEI
	CHEMBL878		racemic	73548 CHEI
	CHEMBL118			18694 CHEI

Step 9: Query filter results By changing the connectivity of the Nitrogen we can find only terminal sulfonamide groups similar to the drug Celebrex.

1. Right click on the Nitrogen atom and choose Element/Custom and add "N,C"

Now let us expand the search a bit by including sulfonyl groups as well as sulfonamides – this will identify Vioxx like molecules as well.

Step 10: Query filter - Custom Element. Now let us expand the search a bit by including sulfonyl groups as well as sulfonamides - this will identify Vioxx like molecules as well.

Query results find Vioxx and Celebrex like chemicals.

CMPD CHEMBLID	mol	MOLREGNO	PAR
7			
CHEMBL122		21697	CHEI
8		67010	CHEI
CHEMBL1055		134333	CHEI

Step 11: Query filter results. By adding to the filters we can identify Vioxx-like chemicals containing sulfonyls and Celebrex-like chemicals containing sulfonamide groups.

10.4.3 Chemical Clustering

Background

This tutorial follows on from the previous tutorial where we made a database of COX-2 inhibitors (Cox2_Inhibitors) and read in a chemical spreadsheet containing IC50 data from ChEMBL (chembl_cox2). In this tutorial we will perform chemical clustering on the ChEMBL chemical spreadsheet.

Tutorial

Cluster the ChEMBL_Cox2 table by chemical substructure.

1. Click here to cluster

2. Choose options as shown

CPMPD	CHEMBLID	mol	MOLREGNO	MOL PREI
1	CHEMBL24441	<chem>N</chem>	32459	BETAHIST
2	CHEMBL1196	<chem>CCOC</chem>	209007	PROPARA
3	CHEMBL1073	<chem>C1=NC=NC=C1</chem>	139286	GLBPIZIDE

Step 1: Cluster Cluster the ChEMBL_Cox2 table by chemical substructure using the options shown in the screenshot.

The cluster is colored by branch and is fully interactive. Selections can be made in the tree or table. The cluster distance can be changed by dragging the bar as shown.

1. Drag to change distance

CMPD	CHEMBLID	mol	MOLREGNO	PA
1	CHEMBL24441	<chem>CNCCc1cccnc1</chem>	32459	CH
2	CHEMBL1201353	<chem>CN(C)C[C@@H](c1cccnc1)c2ccc(Cl)cc2</chem>	675304	CH
3	CHEMBL3	<chem>CN1CCc2ccncc21</chem>	115	CH

Step 2: Change the distance of the tree. The cluster is colored by branch and is fully interactive. Selections can be made in the tree or table. The cluster distance can be changed by dragging the bar as shown.

Use the right click selection tools to find clusters containing known COX-2 drugs.

1. Right click here for more clustering options

CMPD	CHEMBLID	mol	MOLREGNO	PA
573	CHEMBL443	<chem>Cc1cc(O)nc(NC(=O)c2ccc(N)cc2)c1</chem>	2247	CH
574	CHEMBL453	<chem>Cc1cc(O)nc(NC(=O)c2ccc(N)cc2)c1</chem>		
575	CHEMBL865	<chem>Cc1cc(O)nc(NC(=O)c2ccc(N)cc2)c1</chem>	67010	CH

Step 3: Cluster options. Use the right click selection tools to find clusters containing known COX-2 drugs. For example, right click and

choose select centers, explore other options in the right click menu.

10.4.4 Working with Large Chemical Space

10.4.4.1 Build and Visualize Chemical Space

1. File/Open > use Filter MDL Mol Format as SMILES

Building and Visualizing Chemical Space

	smiles	Molecule Name	nof RotB mol	ID	Name
1		C8H13N2O2	4	2000014	ethyl 3-hydrazinobenzoate hydrochloride
2		C8H12N2S	0	3000351	6-methyl-4,5,6,7-tetrahydro-1,3-benzothiazol
3		C10H12O3	3	3013808	(3,5-dimethylphenoxy)acetic acid

table: 250000 rows, 40 columns

Step 1: Read in a large SDF file. In this example we are reading in an SDF file containing >250K chemicals. This is too large for the memory of most desktop computers and so we read it in using the File/Open filter MDL Mol Format as SMILES.



Step 2: Add some chemical properties to the chemical spreadsheet.

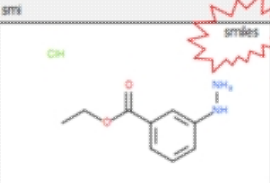
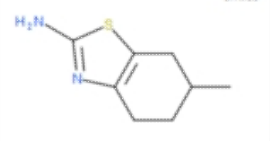
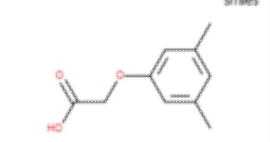
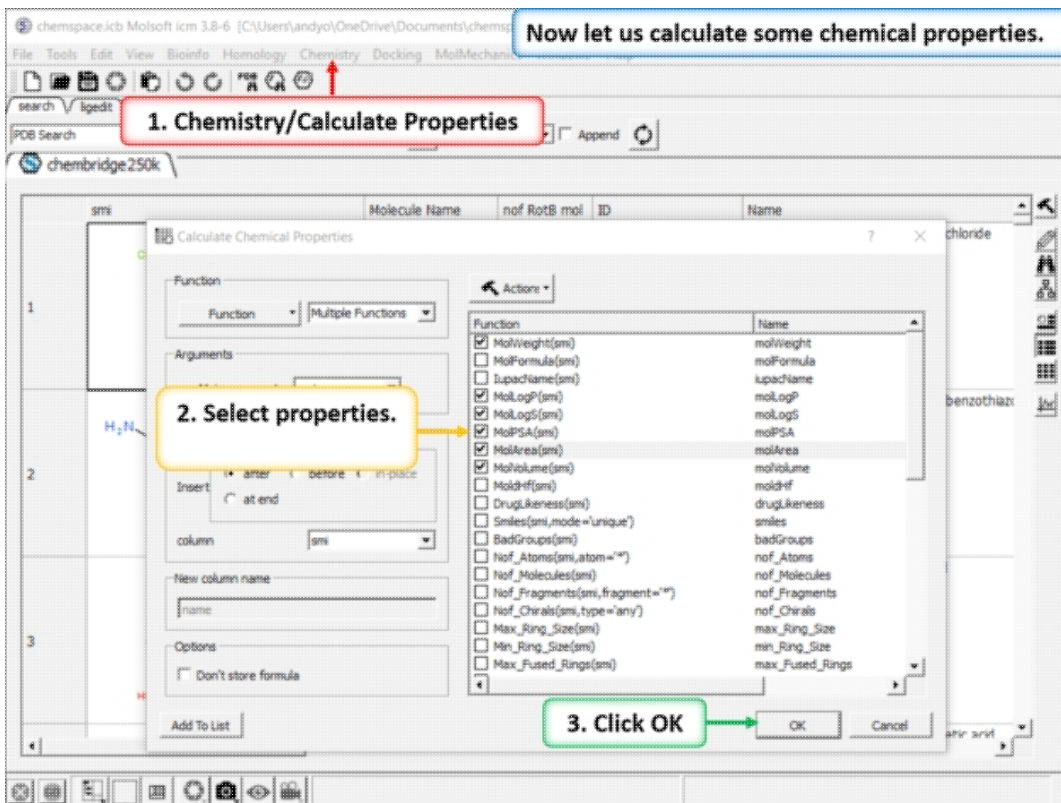
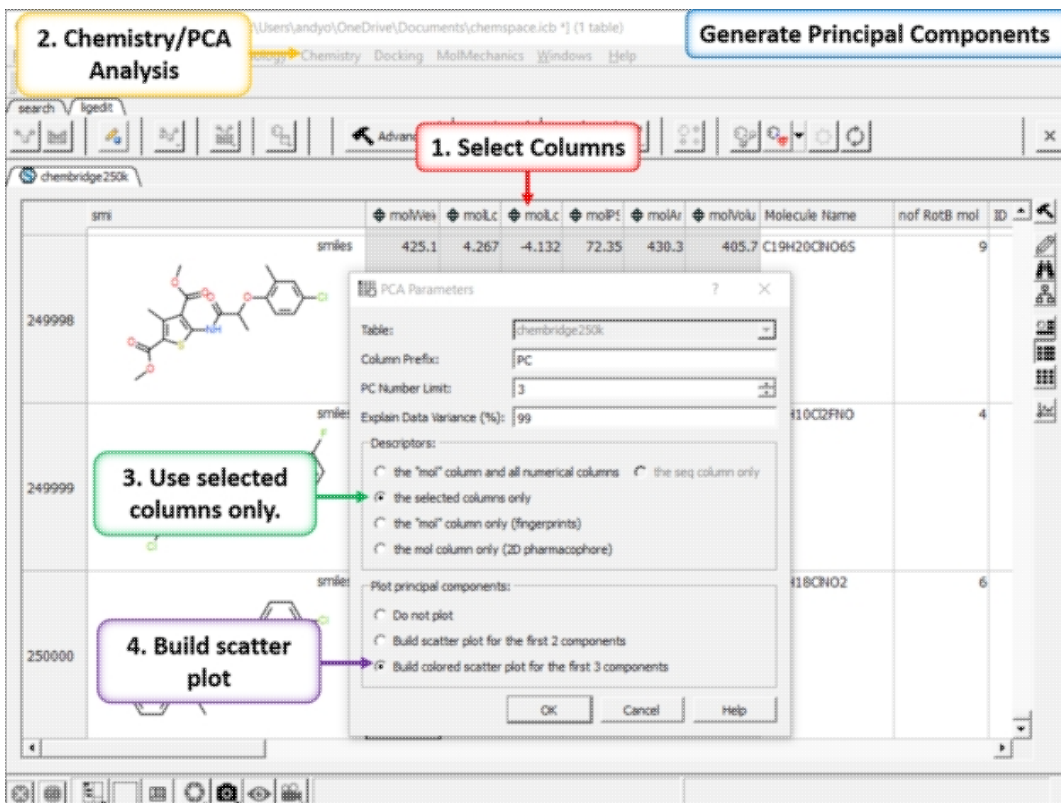

Step 3: PCA Select 6 of the new properties you added to the table. Generate Principal Components using the options in Chemistry/PCA Analysis.

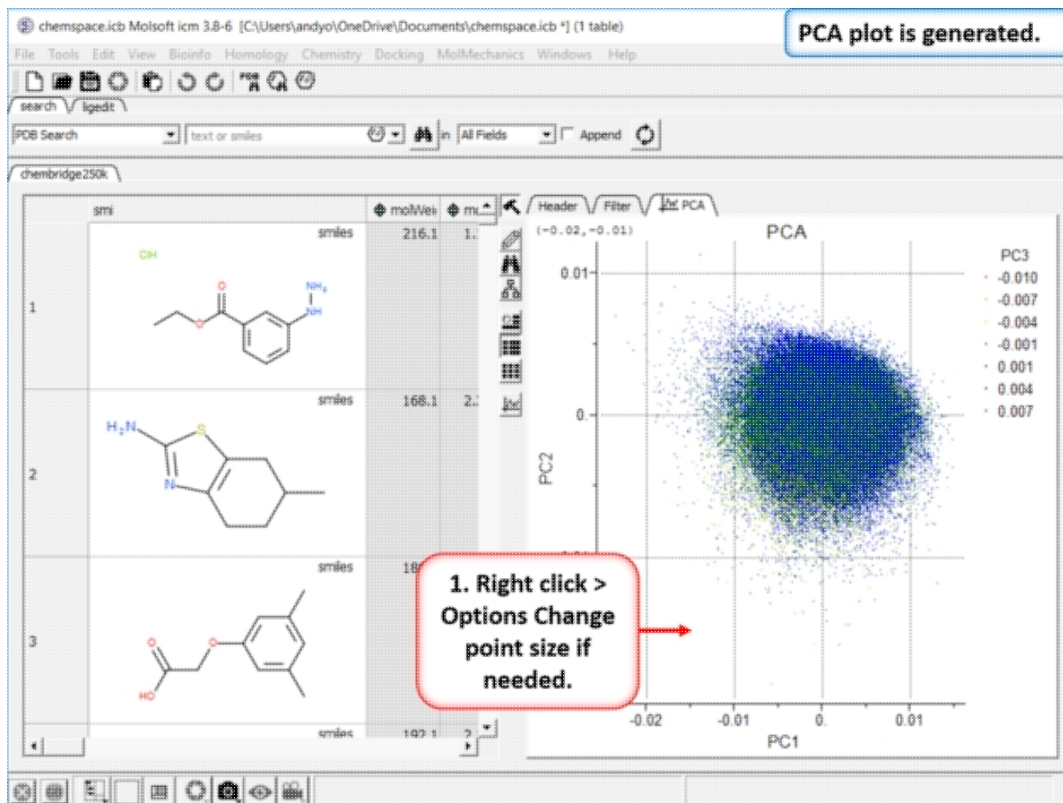

Step 4:PCA Analysis Plot is Generated. Right click on the plot and choose Options to change parameters such as point size.

10.4.4.2 Select Molecules in Chemical Space

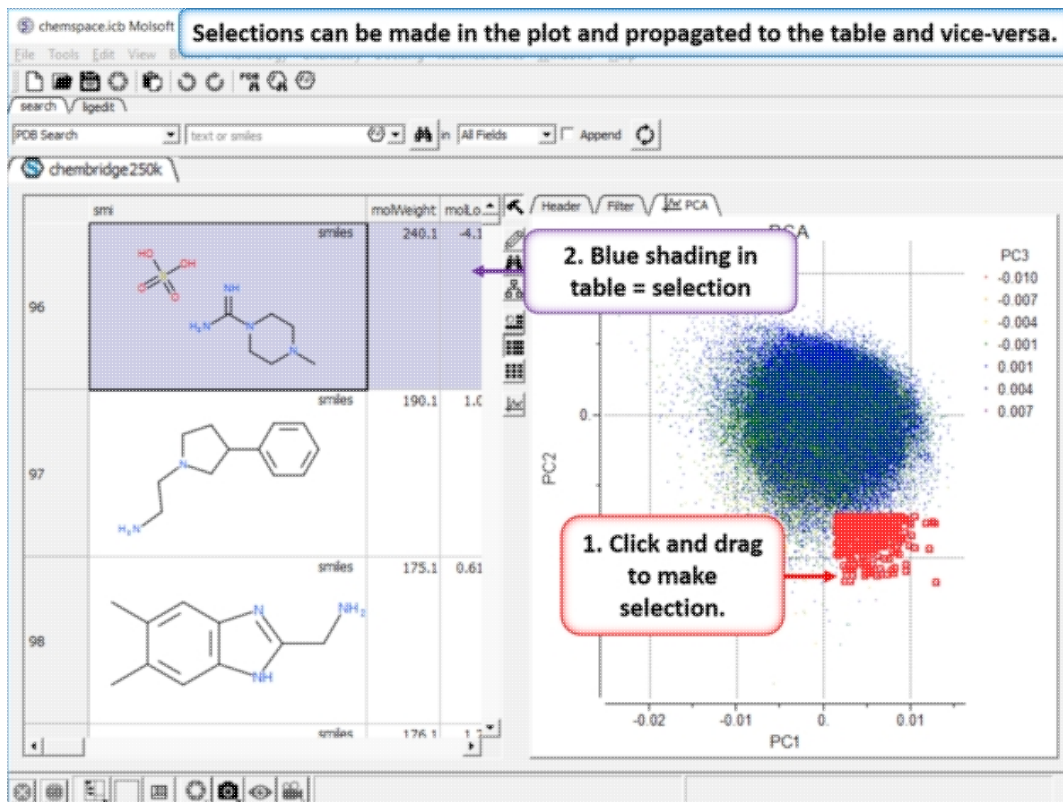

Step 5: Selections. Selections can be made in the plot and propagated to the table and vice-versa.

10.4.4.3 Delete Row

The screenshot displays the chemspace.icb software interface. On the left, a table lists molecules with columns for 'smiles', 'molWeight', and 'molLo'. Row 96 is selected and highlighted in blue. A red callout box with a white background and a red border points to the row header of row 96, containing the text: "1. Right click on a selected row header and choose delete row." Below the table, chemical structures are shown for rows 96 and 98. On the right, a PCA plot shows a scatter of points. A legend on the right side of the plot indicates PC3 values ranging from -0.010 to 0.007. A cluster of points is highlighted in red, corresponding to the selected row in the table. A button labeled "Remove selected molecules." is located in the top right corner of the interface.

Step 6: Delete Rows

10.4.4.4 Append to New Workspace (Spreadsheet)

chemspace.icb Molsoft icm 3.8-6 [C:\Users\andyo\...]

File Tools Edit View Bioinfo Homology Chem...

search | ligedit

PCB Search | text or smiles | in All Fields | Append

chembridge250k

Header Filter PCA

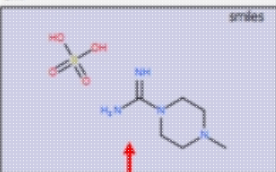
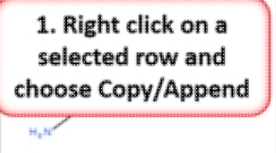
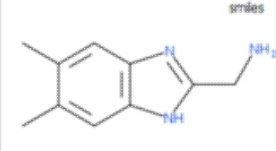
	smiles	molWeight	molLo...
96		240.1	-4.3
97		190.1	1.0
98		175.1	0.61

1. Right click on a selected row and choose Copy/Append

PCA

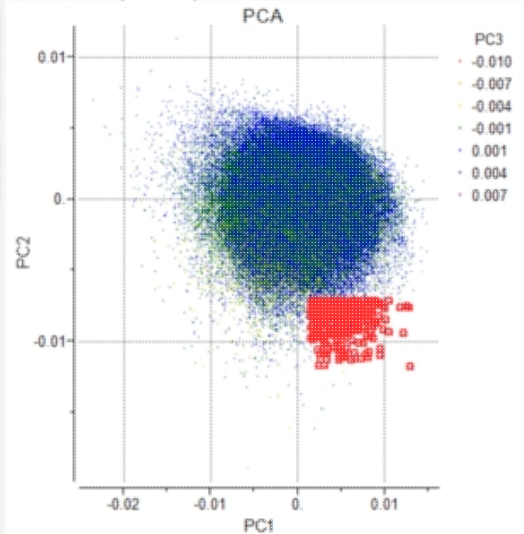

PC3

- 0.010
- 0.007
- 0.004
- 0.001
- 0.001
- 0.004
- 0.007

PC2

PC1

Step 7: Copy or append selected rows to a new chemical spreadsheet.

10.4.4.5 Export Chemical Space to SDF File Format

chemspace.icb Molsoft icm 3.8-6 [C:\Users\andyo\OneDrive\Documents\chemspace.icb *] (1 table)

File Tools Edit View Bioinfo Homology Chemistry Docking MolMechanics Windows Help

search | ligedit

PCB Search | text or smiles | in All Fields | Append

chembridge250k

Header Filter PCA

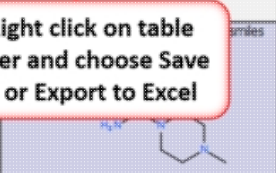
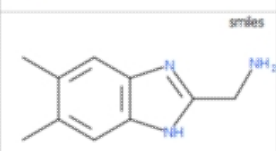
	smiles	molWeight	molLo...
96		240.1	-4.3
97		190.1	1.0
98		175.1	0.61

1. Right click on table header and choose Save as... or Export to Excel

PCA

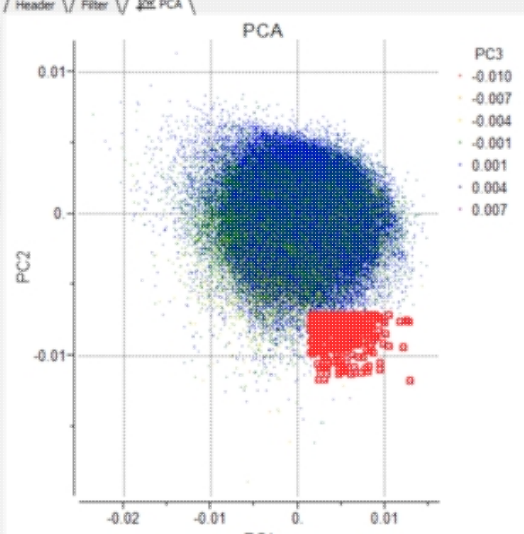

PC3

- 0.010
- 0.007
- 0.004
- 0.001
- 0.001
- 0.004
- 0.007

PC2

PC1

Step 8: Export as SDF, csv or Excel.

10.4.4.6 Project New Molecules in the Chemical Space

chemspace.icb Molsoft icm 3.8-6 [C:\Users\andy\OneDrive\Documents\chemspace.i

Project New Molecules into Chemical Space

2. Tools/Table/Append Row(s)

1. Read in new chemical table.

3. Choose source and target table.

4. Select new rows.

4. Click OK

Step 9: Project New Molecules into Chemical Space Use Tools/Table/Append Row(s).

chemspace

New chemicals are now added to the spreadsheet and selected in the table and plot.

Step 10: New chemicals are now added to the spreadsheet and selected in the table and plot.

10.4.4.7 Distinguish between different sets of molecules in Chemical Space

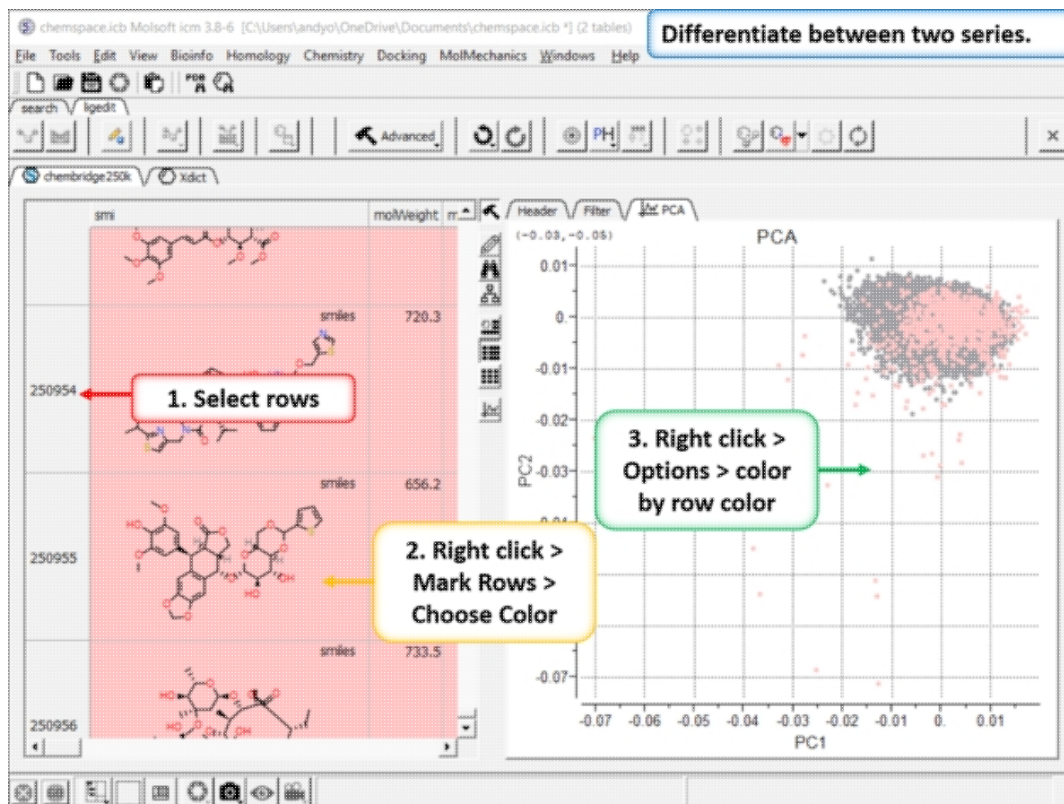

Step 11: Differentiate between two series. You can differentiate between two series by coloring rows and then propagating that row color to the plot.

10.4.4.8 Compare, Merge and Select Duplicates in Chemical Space

1. Chemistry Menu

Compare, Merge and Select Duplicates.

Chemistry Docking MolMechanics Windows

Calculate Properties
Standardize...
Annotate by Substructure...
Align By 2D Scaffold...
Set Formal Charges...
Convert
Generate 3D Conformers...
Generate Tautomers...
Generate Stereoisomers...
Generate Drug from Prodrug...
Generate Prodrug from Drug...
Enumerate Formal Charge States...
Ligand Energetics
Cluster Set
PCA Analysis
MCS Dendrogram
Compare Two Sets...
Merge Two Sets...
Select Duplicates...
MRO
Combinatorial Chemistry
SAR Analysis
Superposition
APF Tools
MolScreen Model
Build Prediction Model
Predict
Load Example Table

chembridge250k ✓ idict ✓ celebre

250954
250955
250956

PCA

Filter PCA

PCA

PC1

Step 12: Compare, Merge and Select Duplicates.

10.4.5 3D Pharmacophore Searching

Objective Undertake a 3D pharmacophore search of a table containing 3D coordinates.

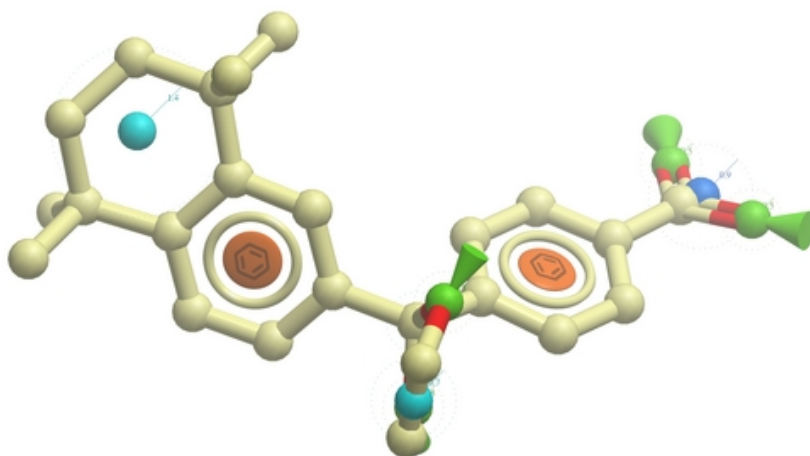

- File/Open **example_ph4.icb** (this file is provided in the ICM distribution and therefore can be found in \$ICMHOME or in Windows)

Program Files/MolSoft

- In this example the 3D pharmacophore has already been extracted from a ligand. To find out how to generate a 3D pharmacophore see the section entitled *Pharmacophore Draw 3D*.
- In this example a table containing 3D coordinates is already provided containing 3D coordinates. The table is called *t_3D*.
- To run 3D pharmacophore searching right click on the name of the pharmacophore object in the ICM Workspace and select **Search Pharmacophore**.
- Select the table *t_3D* from the drop down list and click OK.
- A table of search results will be displayed.

Right click here

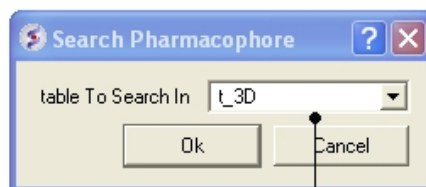
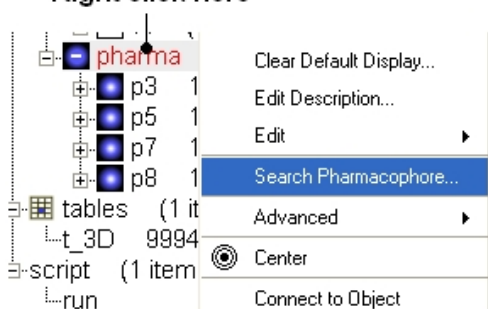

Enter name of table containing 3D coordinates

- You can browse the results by clicking on the table and the ligand will be displayed in the graphical display.
- Remember you can use the check boxes in column L to lock compounds and overlay them.

Browse and lock compound in 3D display

mol	NAME_	molid	confid	L	rmsd	score
chiral,3D->2D		822	189664	<input checked="" type="checkbox"/>	0.00469	100
chiral,3D->2D		824	190194	<input type="checkbox"/>	0.007595	100

Double click to view in 3D

Manual References (Web Links)

3D Pharmacophore Search

10.4.6 2D Pharmacophore Searching

Objective Undertake a 2D pharmacophore search of a chemical spreadsheet.

- File/Open **example_ph4.icb** (this file is provided in the ICM distribution and therefore can be found in \$ICMHOME or in Windows Program Files/MolSoft)
- Chemistry/Chemical Search
- Draw the query as shown below using the

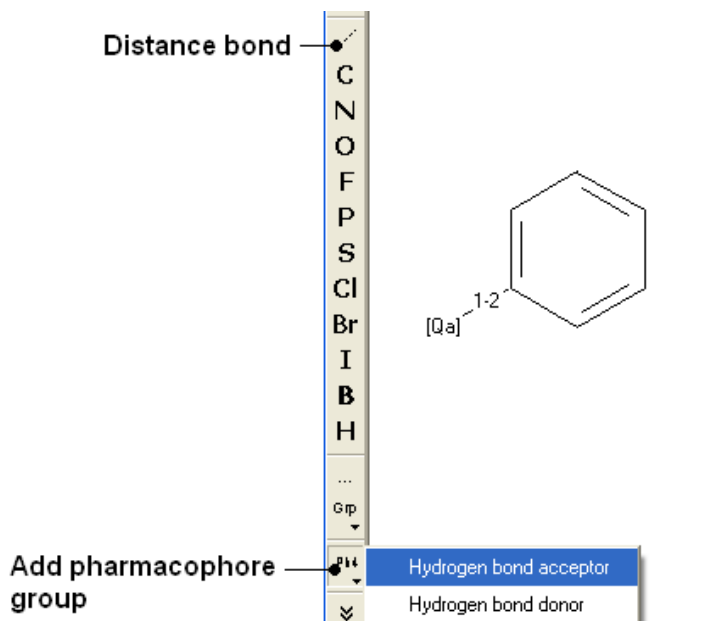

- Fill in the query and results option as shown below.

Data Source

Local Tables MolCart

Query Options

Database

Table t_3D

Search Type Substructure

Maximal # of Hits 1000

Max Distance 0.4

Number of Matches any

Match stereo Ignore Salt

By Selection # Of Hits Only

Result

sult_new Auto Append

New Table Select in Source

Add to DB

Highlight Match Rotate by Match

Display as Grid

Search

Manual References (Web Links)

2D Pharmacophore Search

10.4.7 How to create a Markush structure.

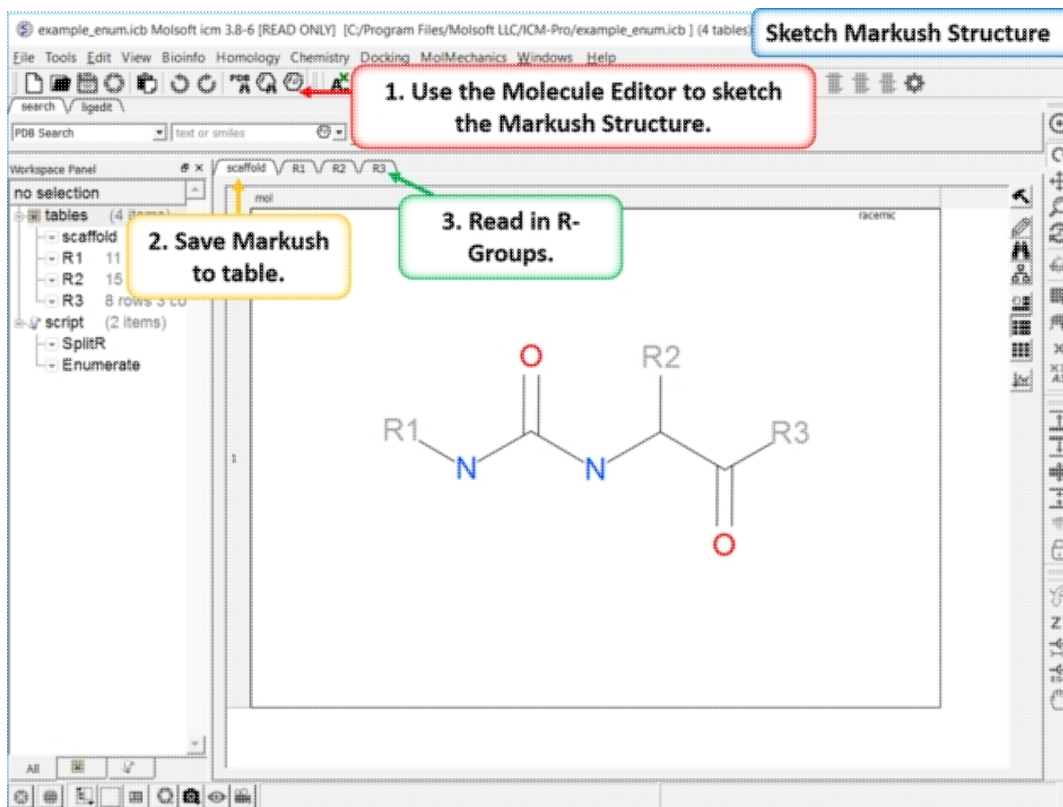

Setup A pre-prepared example is available in File/Open Examples > example_enum.icb. The markush structure has already been drawn and the R-groups have been read into ICM. The Markush structure is ready to be created.

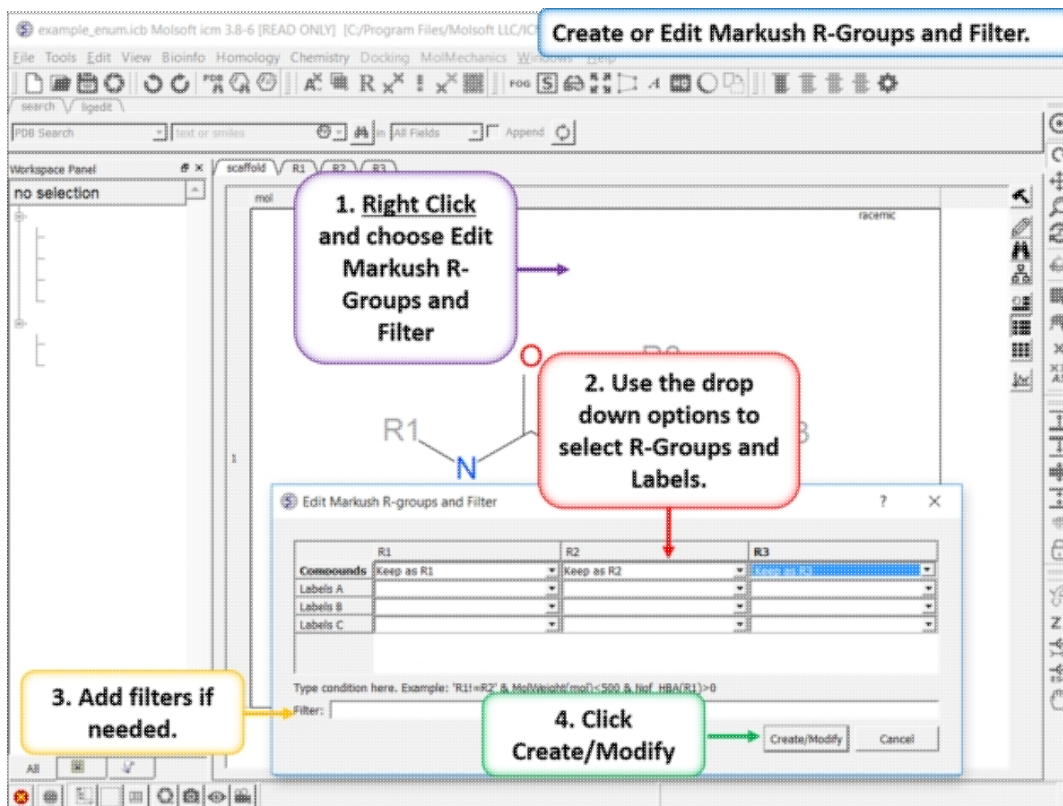

Create or Edit Markush R-Groups and Filter. Right Click and choose Edit Markush R-Groups and Filter. Add the R-groups, labels and filters and then click on Create/Modify.

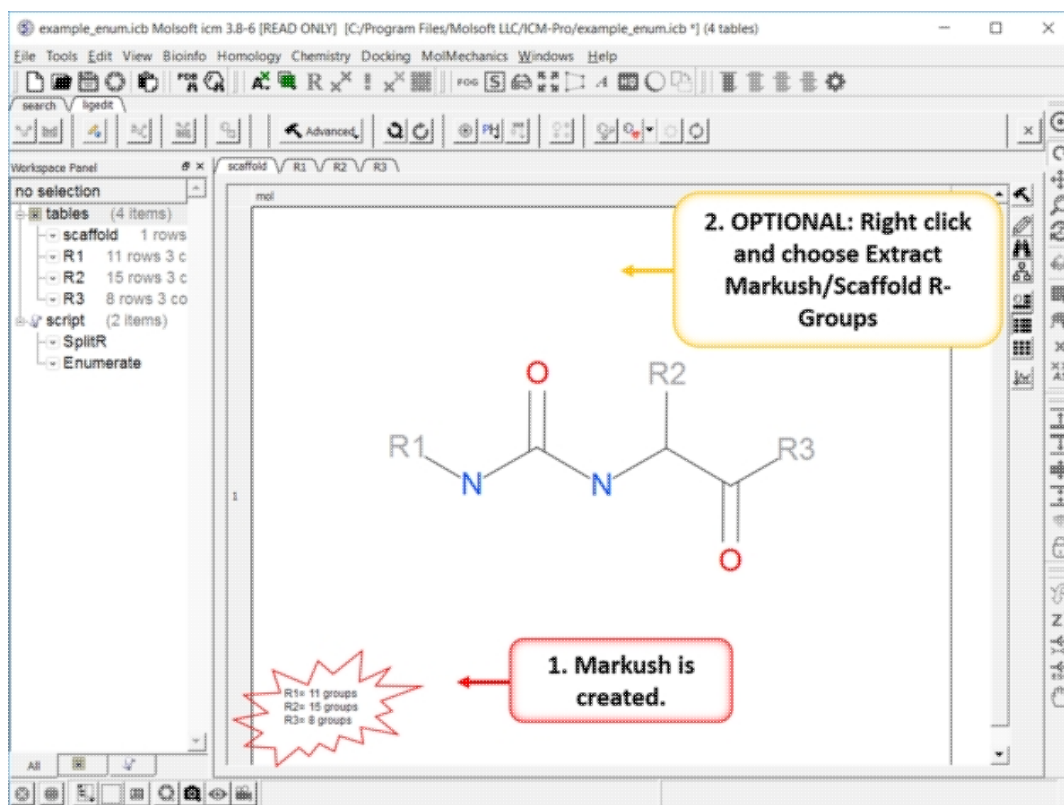

The Markush Structure is Created. If you want to see the R-Groups in a separate table you can extract them by right clicking on the Markush and choose Extract Markush/Scaffold R-Groups.

10.4.8 How to enumerate a Markush library.

| Documentation |

Sketch Markush Structure for Enumeration.

1. Use the Molecule Editor to sketch the Markush Structure.

2. Save Markush to table.

3. Read in R-Groups.

The screenshot shows the Molsoft ICM interface with a central workspace containing a Markush structure: R1NC(=O)N(R2)C(=O)R3. The workspace panel on the left shows a table with columns for scaffold, R1, R2, and R3. The top menu bar includes File, Tools, Edit, View, Bioinfo, Homology, Chemistry, Docking, MolMechanics, and Windows.

Enumeration Setup A pre-prepared example is available in File/Open Examples > example_enum.icb. The markush structure has already been drawn and the R-groups have been read into ICM. The Markush structure is prepared for enumeration.

Chemistry/Combinatorial Chemistry/ Enumerate by Scaffold/Markush.

1. Chemistry/Combinatorial Chemistry/ Enumerate by Scaffold/Markush.

2. Table containing Markush.

3. Row number.

4. Click OK.

The screenshot shows the 'Enumerate by Scaffold/Markush' dialog box open over the same Markush structure. The dialog has a 'Choose Table With Scaffold' checkbox and a dropdown menu showing 'scaffold'. The 'Index' field is set to '1'. The 'Ok' button is highlighted. The workspace panel on the left shows the table with 11 rows for R1, 15 rows for R2, and 8 rows for R3.

Enumerate Library - Step 1: Choose the menu option Chemistry/Combinatorial Chemistry/ Enumerate by Scaffold/Markush.

Select the R-Groups

1. Use the drop down options to select R-Groups and Labels.

2. Add filters if needed.

3. Click Enumerate

	R1	R2	R3
Compounds	R1.mol	R2.mol	R3.mol
Labels A	R1.ID1	R2.ID1	R3.ID1
Labels B			
Labels C			

Type condition here. Example: 'R1=R2' & MolWeight(mol)<500 & Nof_HBA(R1)>0
 Filter: IsAliphatic(R1) & IsAromatic(R2)

Enumerate Cancel

Enumerate Library - Step 2: Select R-groups, labels and filters.

Enumerated library will be returned in a new chemical table.

1. Enumerated result table.

	mol	R1 ID1	R2 ID1	ID1
1		ID9	ID1	ID1
2		ID9	ID2	ID1
3		ID9	ID14	ID1
4		ID9	ID1	ID2

Results Table The enumerated library will be displayed in a new chemical table.

10.4.9 How to decompose a library based on a Markush structure.

The screenshot shows the Molsoft ICM interface. The 'File' menu is open, and '1. File/Open sdf' is highlighted. A blue button in the top right corner says 'Read in Chemicals to Decompose'. Below the menu is a search bar with 'PCB Search' and 'text or smiles' options. The main window displays a table with the following data:

mol	Molecule Name	ACTIVITY	SET	Min dist	Avg dist
1	13-10	7.48	1	999.9	999.9
2	13-6a	4	3	0.22	0.56
3	13-7a	7.12	2	0.08	0.55
	13-7c	6.89	1	999.9	999.9

Read in the SDF File to be decomposed. A prepared ICM file containing COX-2 inhibitors with a common scaffold and activity data can be downloaded from here: <ftp://ftp.molsoft.com/pub/workshop/> (1. cut and paste the address into a web browser. 2. Right click on COX2_Decomposition_Example.icb and choose "Save Link As". 3. Open the .icb in ICM File/Open).

COX2_Decomposition_Example.icb Molsoft icm 3.8-6 [H:\icmd\mani\COX2_Decomposition_Example.icb] (1 table)

File Tools Edit View Bioinfo Homology Chemistry Help

search ligedit

POB Search text or smiles in All Fields Append

1. Open the Molecular Editor

Sketch the Markush Structure

ICM Molecule Editor [new file *] C3H4N2X2

File Edit View Templates Help

C3H4N2X2

mol

1

2

3

C N O F P S

R1 R2

2. Use the bonds and atoms to sketch.

3. Right click on an atom and choose Element R1, R2..

Name	Value
1 Formula	C3H4N2X2
2 Smiles	*[C]1[R 1][R 2]
3 Name/IUPAC	
4 InChI	
5 InChIKey	
6 MolWeight	66.0218
7 HBA	1
8 HBD	0
9 RotB	0
10	
11	
12	
13	
14 MolLogP	-0.0819572
15 MolLogS	-1.1377
16 MolPSA	14.4978
17 Volume	86.1443
18 Chem Alerts	
19 Groups	Pyrazole

13-7c 6.89 1 999.9 999.9

Sketch the Markush Structure. Sketch the Markush structure using the Molecule Editor.

COX2_Decomposition_Example.icb Molsoft icm 3.8-6 [H:\icmd\mani\COX2_Decomposition_Example.icb] (1 table)

File Tools Edit View Bioinfo Homology Chemistry Docking MolMechanics Windows

search ligedit

POB Search text or smiles in All Fields Append

Add Markush Structure to New Table.

COX2_Decomposition Scaffold

mol

1

R1

ICM Molecule Editor [new file *] C3H4N2X2

File Edit View Templates Help

C3H4N2X2

C N O F P S Cl Br I

R1 R2

1. Add Markush structure to chemical table

Name	Value
1 Formula	C3H4N2X2
2 Smiles	*[C]1[R 1][R 2]
3 Name/IUPAC	
4 InChI	
5 InChIKey	
6 MolWeight	66.0218
7 HBA	1
8 HBD	0
9 RotB	0
10 DrugLikeness	1.29746
11 MolArea	83.3782
12 MolDrf	55.5541
13 MolHalfLife	1.13819
14 MolLogP	-0.0819572
15 MolLogS	-1.1377
16 MolPSA	14.4978
17 Volume	86.1443
18 Chem Alerts	
19 Groups	Pyrazole

Create Markush Structure Table Save the Markush structure to a new chemical table.

COX2_Decomposition_Example.icb Molsoft icm 3.8-6 [H:\icmd\yman\COX2_De...]

Chemistry/SAR Analysis/R-Group Decomposition

File Tools Edit View Bioinfo Homology Chemistry Docking MolMechan...

search | ligedit

PCB Search

1. Chemistry/SAR Analysis/
R-Group Decomposition.

mol

Molecule Name

C3H2N2X2

1

R1

R2

2. Scaffold table

R-Group Decomposition

Choose Table With Scaffold Draw New Scaffold

Scaffold

Index

1

Table For Decomposition

COX2_Decomposition_Example

Structure Column

mol

Generate Single SAR Table

Auto Add Missing R-Groups

Add Original Compounds

3. Table for decomposition.

4. Click OK.

Ok Cancel Help

Chemistry/SAR Analysis/ R-Group Decomposition.

COX2_Decomposition_Example.icb Molsoft icm 3.8-6 [H:\icmd\yman\COX2_Decomposition_Exam...]

R-Group Decomposition Results Table.

File Tools Edit View Bioinfo Homology Chemistry Docking MolMechanics Windows

search | ligedit

PCB Search

text or smiles

All Fields

Append

COX2_Decomposition... Scaffold T_sar

	R1	R2	R3	R4	mol	Molecule Name	ACTIVITY	SET
1	H → *					13-6a	4	3
2						13-7c	6.89	1
3						13-10	7.48	1
4						13-7a	7.12	2

Results Table. The decomposition data will be displayed in a new table. You can sort the columns by Activity or R-Group. The R-group decomposition can also be used to build more complex SAR tables as described here.

10.4.10 How to enumerate a chemical library by reaction.







example_react1.icb Molsoft Chem3D 3.6.1g [C:\Program Files\Molsoft LLC\DM-Pro\example_react1_4\1\1 tables]

How to enumerate a chemical library by reaction. (2)

Hantzsch Dihydropyridine (Pyridine) Synthesis

This reaction allows the preparation of dihydropyridine derivatives by condensation of an aldehyde with two equivalents of a β -keto ester in the presence of ammonia. Subsequent oxidation (or dehydrogenation) gives pyridine-1,5-dicarboxylates, which may also be decarboxylated to yield the corresponding pyridines.

Click here to try a reaction.

mol	Molwt	mol	ID	vendor
8796	136		D1	apollonchem 2039 mol 50000171 amaa 37017 01-0
8798	118		D2	amaa
8823	156		D3	amaa 3629495
8826	132		D4	mol 50001189
8795	156		D5	mol 50001263
4821	142.1		D6	mol 50001467

1. Read in a table of your reactants

```
lscm/de> undisplay window
lscm/de> _m_maxentProject = ""
lscm/de> openFile "C:\Program Files\Molsoft LLC\DM-Pro\example_react1.icb" 1 yes no no no ""
Info: 6 zball objects read (skipped 3) from C:\Program Files\Molsoft LLC\DM-Pro\example_react1.icb
lscm/de> |
```

example_react1.icb Molsoft Chem3D 3.6.1g [C:\Program Files\Molsoft LLC\DM-Pro\example_react1_4\1\1 tables]

How to enumerate a chemical library by reaction. (1)

Hantzsch Dihydropyridine (Pyridine) Syn

This reaction allows the preparation of dihydropyridine derivatives by condensation of an aldehyde with two equivalents of a β -keto ester in the presence of ammonia. Subsequent oxidation (or dehydrogenation) gives pyridine-1,5-dicarboxylates, which may also be decarboxylated to yield the corresponding pyridines.

Click here to try a reaction.

1. Sketch reactants and products in the molecule editor



```
lscm/de> undisplay window
lscm/de> _m_maxentProject = ""
lscm/de> openFile "C:\Program Files\Molsoft LLC\DM-Pro\example_react1.icb" 1 yes no no no ""
Info: 6 zball objects read (skipped 3) from C:\Program Files\Molsoft LLC\DM-Pro\example_react1.icb
lscm/de> |
```

example_reactant.tbl Molsoft Chem3d 3.6.1g [C:\Program Files\Molsoft\LCDCM-Pro\example_reactant.tbl] table1

How to enumerate a chemical library by reaction. (3)

1. Chemistry/Enumerate by Reaction

2. Enter the name of the table and the row number containing your reaction sketch (Reaction)

chem/dest> molcopy window
 chem/dest> _m_react_results = **
 chem/dest> openfile "C:\Program Files\Molsoft\LCDCM-Pro\example_reactant.tbl" 1 yes no no **
 info: 6 shell objects read (skipped 3) Error C:\Program Files\Molsoft\LCDCM-Pro\example_reactant.tbl
 chem/dest> _

example_reactant.tbl Molsoft Chem3d 3.6.1g [C:\Program Files\Molsoft\LCDCM-Pro\example_reactant.tbl] table1

How to enumerate a chemical library by reaction. (4)

1. Enter the names of the tables with your reactants and a new table called "react_results" will be displayed with your new library

chem/dest> openfile "C:\Program Files\Molsoft\LCDCM-Pro\example_reactant.tbl" 1 yes no no **
 info: 6 shell objects read (skipped 3) Error C:\Program Files\Molsoft\LCDCM-Pro\example_reactant.tbl
 chem/dest> molid = _chem_pyr.rxn[1]
 chem/dest> _m_rnz = Anq[molid, enumerate]

10.4.11 Detecting Activity Cliffs

There are two methods to detect activity cliffs Matched Pair and Structure--activity landscape index(SALI).

The Matched Pair Analysis performs Maximum Common Substructure search on various pairs to find one-point variations in R-group. It returns a chemical spreadsheet with the delta difference in Activity and a score which is a combination of delta activity and size of R-group therefore looking for smaller R-groups with bigger activity difference.

COX2_Decomposition_Example.icb **Load in example sdf file containing inhibitors and activity data from ChEMBL.**

File Tools Edit View Bio

1. File/Open SDF

	Molecule Name	ACTIVITY	SET	Min dist	Avg dist	
1	13-10		7.48	1	999.9	999.9
2	13-6a		4	3	0.22	0.56
3	13-7a		7.12	2	0.08	0.55
4	13-7c		6.89	1	999.9	999.9
	8-10a		4	3	0.19	0.55

Read in Activity Data A prepared ICM file containing COX-2 inhibitors with a common scaffold and activity data can be downloaded from here: <ftp://ftp.molsoft.com/pub/workshop/> (1. cut and paste the address into a web browser. 2. Right click on COX2_Decomposition_Example.icb and choose "Save Link As". 3. Open the .icb in ICM File/Open).

Run Matched Pair Analysis (MMP /MPA)

1. Chemistry/SAR Analysis/Matched Pair Analysis

2. Check the option Use Activity

3. Select activity column

4. Click OK

Run Matched Pair Analysis

- Chemistry/SAR Analysis/Matched Pair Analysis
- Enter the Input table name.
- Check the option "Use Activity".
- Click OK.

Matched Pair Analysis Results Table and Interactive Plot

Sortable table (e.g. sort by Score)

Fully interactive plot

*{Matched Pair Analysis Results} A table of the results will be displayed - you can sort by score. The plot is displayed activity 1 versus activity 2 colored and sized by score (red is better). The plot and the table are linked so a selection in one is propagated to the other.

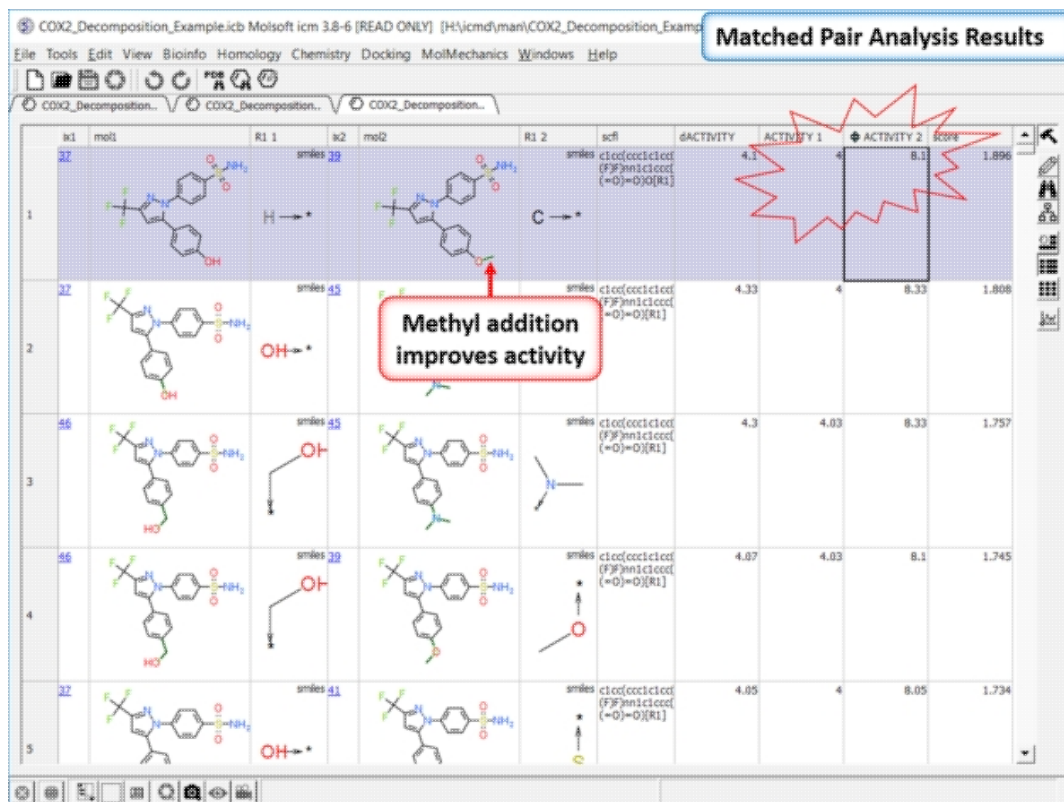

Results Analysis The top scoring comparison shows that the addition of a methyl group significantly improves activity. You can also add filtering e.g. R1_2 filter and select methyl groups - right click on column header and choose filter.

The SALI method developed by John Van Drie is calculated using chemical distances and activity and can identify different changes compared to MPA.

COX2_Decomposition_Example.icb Molsoft icm 3.8-6 [READ ONLY] [H:\icmd\man\COX2_D

File Tools Edit View Bioinfo Homology Chemistry Docking MolMechanics Windows

Structure--activity landscape index (SALI): identifying and quantifying activity cliffs.

1. Chemistry/SAR Analysis/SALI

mol

	SET	Min dist	Avg dist
1	7.48	1	999.9
2			
3			
4	13-7c	6.89	1
			999.9
			999.9
	9-10a	4	3
			0.19
			0.55

Generate SALI Table

Input Table: COX2_Decomposition_Example ActivityColumn: ACTIVITY

Use Log Activity

Distance Cutoff: 0.15

Hint: Generates table of compounds pairs and calculate SALI (Structure-activity landscape index). PMID: 18303878

2. Click OK

mol

Structure--activity landscape index (SALI): identifying and quantifying activity cliffs. Use the menu option Chemistry/SAR Analysis/SALI.

COX2_Decomposition_Example.icb Molsoft icm 3.8-6 [READ ONLY] [H:\icmd\man\COX2_Decomposition_Example.icb *] (2 tables)

MolMechanics Windows Help

Sortable table (e.g. sort by SALI)

ix1	mol1	ix2	mol2
11		32	
32		92	
12		18	
31		62	
32		28	

Header Filter ACTIVITY1...

(4.01, 4.49)

SALI

- 0
- 32
- 65
- 97
- 129
- 162
- 194

Fully interactive plot

ACTIVITY1

SALI Results A fully interactive table and plot is returned containing the SALI index.

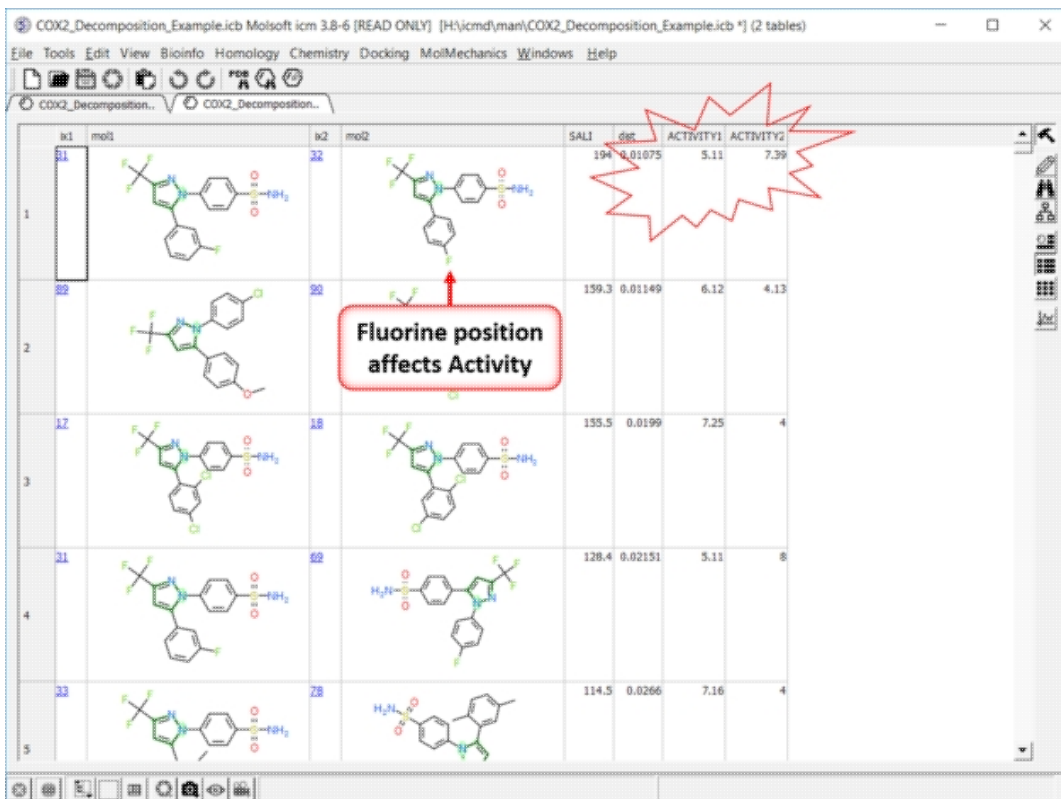

Results In this example the fluorine movement around the ring affects activity.

Index

- 2D, 5.8.8, 7.3.24, 7.3.28, 7.13, 7.16.1, 7.16.3
 - bioisostere, 7.8.1
 - from PDB, 7.1.1
 - to 3D, 7.16, 7.16.2
 - depiction, 7.16.1
- 3D, 5.6, 5.8.8, 7.1.3, 7.3.24, 7.3.28, 7.3.31, 7.16.1, 10.2
 - chemical, 7.4.16
 - interactive ligand editor, 2.6.5
 - object, 5.3.9
 - print, 5.7
 - printing, 5.7
 - stereo, 5.6
 - bioisostere, 7.8.2
 - predict local flexibility, 4.5.12
 - protein health, 4.5.11
 - tools identify ligand
 - binding pocket, 4.5.14
 - oda, 4.5.13
- 4D docking, 3.2.2
- ActiveICM, 2.5.1.12
- Atom Single Style, 3.7.3
- Baell, 7.4.9
- Beep, 3.7.11
- BlastDB Directory, 3.7.2
 - alphas, 5.8.3
- COLLADA, 2.5.1.7
- CPK, 2.6.1
- ChEMBL, 3.2.3, 7.1
- Chemical Cluster, 10.4.3
 - Search, 10.4.2
- Clash Threshold, 3.7.10
- DNA, 3.3
- Decomposition, 7.30.2
- Dock Directory, 3.7.2
- Drug Bank, 3.2.8
- Editor, 3.7.2
- FILTER.Z, 3.7.2
 - gz, 3.7.2
 - uue, 3.7.2
- FTP.createFile, 3.7.11
 - keep File, 3.7.11
 - proxy, 3.7.11
- Filter.zip, 3.7.2
- Force Auto Bond Typing, 3.7.11
- GIF, 2.5.1.15, 5.16, 5.16.2
- GRAPHIC.store Display, 3.7.3
 - NtoC Rainbow, 3.7.4
 - alignment Rainbow, 3.7.4
 - atomLabelShift, 3.7.7
 - ballStickRatio, 3.7.1
 - center Follows Clipping, 3.7.3
 - clash Style, 3.7.3
 - clashWidth, 3.7.3
 - clip Grobs, 3.7.3
 - Skin, 3.7.3
 - Static, 3.7.3
 - discrete Rainbow, 3.7.4
 - displayLineLabels, 3.7.7
 - displayMapBox, 3.7.3
 - distance Label Drag, 3.7.1
 - dnaBallRadius, 3.7.9
 - dnaRibbonRatio, 3.7.9
 - dnaRibbonWidth, 3.7.9
 - dnaRibbonWorm, 3.7.9
 - dnaStickRadius, 3.7.9
 - dnaWormRadius, 3.7.9
 - font Scale, 3.7.7
 - fontColor, 3.7.7
 - fontLineSpacing, 3.7.7
 - grobLineWidth, 3.7.3
 - hbond Ball Period, 3.7.1
 - Style, 3.7.1
 - hbondAngleSharpness, 3.7.1
 - hbondMinStrength, 3.7.1
 - hbondStyle, 3.7.1
 - hbondWidth, 3.7.1
 - hetatmZoom, 3.7.1
 - hydrogenDisplay, 3.7.1
 - light, 3.7.3
 - lightPosition, 3.7.3
 - mapLineWidth, 3.7.3
 - occupancy Radius Ratio, 3.7.3
 - occupancyDisplay, 3.7.3
 - quality, 3.7.3
 - rainbow Bar Style, 3.7.4
 - resLabelDrag, 3.7.7
 - resize Keep Scale, 3.7.3
 - ribbonRatio, 3.7.9
 - ribbonWidth, 3.7.9
 - ribbonWorm, 3.7.9
 - rocking, 3.7.4
 - Range, 3.7.4
 - Speed, 3.7.4
 - selectionStyle, 3.7.3
 - site Label Drag, 3.7.7

- siteArrow, 3.7.7
- stereoMode, 3.7.3
- stickRadius, 3.7.1
- surfaceDotDensity, 3.7.3
- surfaceDotSize, 3.7.3
- surfaceProbeRadius, 3.7.3
- transparency, 3.7.3
- wire Width, 3.7.1
- wormRadius, 3.7.9
- xstick Backbone Ratio, 3.7.1
 - Hydrogen Ratio, 3.7.1
 - Style, 3.7.1
 - Vw Ratio, 3.7.1
- GROB.arrowRadius, 3.7.3
 - atomSphereRadius, 3.7.3
 - contourSigmaIncrement, 3.7.3
 - relArrow Size, 3.7.3
 - relArrowHead, 3.7.3
- GUI.auto Save, 3.7.4
 - Interval, 3.7.4
 - enumeration Memory Limit, 3.7.11
 - max Nof Recent Files, 3.7.11
 - Sequence Length, 3.7.4
 - splash Screen Delay, 3.7.11
 - Image, 3.7.11
 - table Row Mark Colors, 3.7.4
 - workspace Folder Style, 3.7.4
 - workspaceTabStyle, 3.7.4
- HTTP.proxy, 3.7.11
 - support Cookies, 3.7.11
 - user Agent, 3.7.11
- How To Guide, 2
- Html, 3.2.1.6
- Http Read Style, 3.7.11
- Hydrogen.bond, 3.7.5
- ICM Browser How To, 2.1
 - Pro How To, 2.2
- IMAGE.bondLength2D, 3.7.6
 - color, 3.7.6
 - compress, 3.7.6
 - gammaCorrection, 3.7.6
 - generateAlpha, 3.7.6
 - lineWidth, 3.7.6
 - lineWidth2D, 3.7.6
 - orientation, 3.7.6
 - paper Size, 3.7.6
 - previewResolution, 3.7.6
 - previewer, 3.7.6
 - print, 3.7.6
 - printerDPI, 3.7.6
 - scale, 3.7.6
 - stereoAngle, 3.7.6
 - stereoBase, 3.7.6
 - stereoText, 3.7.6
- INCHI, 7.16.2
- Icm Prompt, 3.7.10
- InChi, 7.3.20, 7.4.12, 7.16.2
 - key, 7.3.20
 - Directory, 3.7.2
- JPEG, 2.5.1.15
- KMZ, 2.5.1.7
- Log Directory, 3.7.2
- LogP, 8.6
- LogS, 8.6
- MOL, 7.7.3.3, 7.3.24, 7.3.25, 7.3.26, 7.3.27, 8.2
- MOLT, 9.1
- MOVIE.frame Grab Mode, 3.7.4
- MPO, 7.28
- Map Atom Margin, 3.7.10
 - Sigma Level, 3.7.10
- Markush, 10.4.9
 - create, 10.4.7
 - File Size Mb, 3.7.11
- Max_Fused_Rings, 7.10
- Mnconf, 3.7.10
- MolPSA, 7.10
- MolVol, 7.10
- Molcart, 7.5.3
- MoldHf, 7.10
- Movie.fade Nof Frames, 3.7.4
 - quality, 3.7.4
 - Auto, 3.7.4
- Nof_Atoms, 7.10
- Nof_Chirals, 7.10
- Nof_HBA, 7.10
- Nof_HBD, 7.10
- Nof_Rings, 7.10
- Nof_RotBonds, 7.10
- Output Directory, 3.7.2
- PAINS, 7.4.9, 7.10.2
 - chemica, 7.4.9
- PCA, 10.4.4
 - analysis, 7.23
- PDB, 3.2.1.6, 4.1.2, 4.3.3, 7.1.1

- Style, 3.7.2
- link, 8.1.39
- Search, 2.5.2.12, 2.5.2.13, 2.5.2.14, 2.5.2.15, 2.5.2.16
 - Field, 2.5.2.13
 - Homology, 2.5.2.15
 - Identity, 2.5.2.14
 - Sequence, 2.5.2.16
- convert, 4.1.2
- PFAM, 2.5.1.7
- PLOT.Yratio, 3.7.8
 - color, 3.7.8
 - date, 3.7.8
 - draw Tics, 3.7.8
 - font, 3.7.8
 - fontSize, 3.7.8
 - labelFont, 3.7.8
 - lineWidth, 3.7.8
 - logo, 3.7.8
 - markSize, 3.7.8
 - orientation, 3.7.8
 - paper Size, 3.7.8
 - previewer, 3.7.8
 - rainbowStyle, 3.7.8
 - seriesLabels, 3.7.8
- PNG, 2.5.1.15, 3.1.14, 5.16, 5.16.2
- Projects Directory, 3.7.2
- Prosite Dat, 3.7.2
 - Viewer, 3.7.2
- Pub Chem, 3.2.9
- PubMed, 3.2.1.7
 - Reference, 8.1.39
- Pubchem, 3.2.9
- QSAR, 8.6
- R, 7.7, 7.30.1
- R-Group, 7.30.2
- RMSD, 4.4.2
- RNA, 3.3
- Ramachandran Plot, 4.5.9
- Real Format, 3.7.10
 - Label Shift, 3.7.7
 - Style, 3.7.7
- SALI, 7.30.4, 10.4.11
- SAR, 8.4.23, 8.6
 - table, 7.30.2, 10.4.9
- SDF, 7.7.3.24, 7.3.25, 7.3.26, 7.3.27, 8.2
- SEQUENCE.site Colors, 3.7.4
- SITE.label Style, 3.7.7
 - labelOffset, 3.7.7
 - wrap Comment, 3.7.7
- SLIDE.ignore Background Color, 3.7.4
 - Fog, 3.7.4
- SMILES, 7.1.2, 7.2.4, 7.4.12
- Select Min Grad, 3.7.10
- Show Res Code In Selection, 3.7.7
- SureChEMBL, 3.2.4
- Swissprot, 2.5.1.7
 - Dat, 3.7.2
 - link, 8.1.39
- Temp Directory, 3.7.2
- USER.email, 3.7.11
 - friends, 3.7.11
 - full Name, 3.7.11
 - organization, 3.7.11
 - phone, 3.7.11
- Uniprot, 8.1.39
- Van Drie, 7.30.4
 - Label Style, 3.7.7
- Water Radius, 3.7.10
- Wire Style, 3.7.1
- XPDB Directory, 3.7.2
- Xstick, 2.6.1
 - a-bright, 2.6.2
- acceptor, 7.4.9
- active, 6.7
- activeICM, 6.8
- activeicm, 6.7, 6.12, 6.14, 6.14.1
 - advanced, 6.14
 - background images, 6.15
 - control, 6.13
- activeicmjs, 6.16
- activity cliff, 7.30.4, 7.30.5, 10.4.11
 - tutorial, 10.4.11
- activityy, 8.6
- add database, 7.9.3
 - new data, 7.3.7
- adding fragment, 7.4.8
 - in editor, 7.4.8
- administration, 7.9.5
- album, 5.15.3
- alias, 7.4.5
- align, 3.1.11, 7.13
 - color 2D scaffold, 7.13
- alpha, 2.6.2
 - channel, 3.7.6

- amidinium, 7.14
- amino acid, 3.3
 - acids, 7.4.6
- anaglyph, 5.6
- analysis, 2.5.4
- angle, 4.5.7, 4.5.8, 5.8.5, 5.9, 5.12.6
- animate, 2.5.3.15, 5.10.7
 - view, 5.10.7
- animation, 5.10.7.1, 5.10.7.2, 5.10.7.3, 5.10.7.4
 - store, 5.10.7.4
- animations, 6
- annotate, 3.6.21, 7.12
 - by substructure, 7.12
 - plot, 8.4.22
- antialias, 2.5.1.15, 2.5.3.10
 - lines, 2.5.3.17
 - lines, 2.5.3.17
- apf, 4.4.6
- append, 8.1.43
 - table, 8.1.43
 - rows, 2.5.10.7
- area, 4.5.3, 4.5.13, 10.3.5
- aromatic, 7.3.28
- arrange, 3.1.13.1
 - window, 3.1.13.1
- as2_graph, 3.6.5
- assign, 5.1.3
 - 2D coordinates, 7.16.1
- atom, 3.7.5, 7.3.28
- atomLabelStyle, 3.7.7
- atomic property fields, 4.4.6
- attachment, 7.4.3, 7.5.1
 - point, 7.29.4
- author, 3.2.1.3
 - close tree, 7.22.5
 - play slide, 6.13
- ave, 8.7.1
- avi, 5.16, 5.16.2
- axes, 8.4.14
- axis, 8.4.10
 - options, 8.4.9
 - grid, 8.4.9
 - range, 8.4.9
 - title, 8.4.9
- b-factor, 4.5.12, 10.3.10
- backbone, 5.1.10
- background, 5.4.2, 5.4.3
 - images activeicm, 6.15
 - image, 5.4.3
- backup, 2.5.2.11
- bad, 7.10
 - groups, 7.4.9
- ball, 3.7.5
 - and stick, 2.6.1
- balloon, 8.4.24
- bases, 7.4.6
- basicsel, 3.6.2
- best, 7.3.34
- bicyclics, 7.4.6
- binding properties, 5.3.1
- bioinfo menu, 2.5.4
- bioisoester, 7.8
- bioisostere, 7.8, 7.8.1, 7.8.2
- biological, 4.3.3
- biomolecule, 2.5.5, 4.3.3, 10.3.8, 10.3.12
- blast, 3.2.5
 - search, 3.2.5
- bond, 4.2.3, 4.2.3.1, 4.2.3.2, 7.4.10
- bonding, 5.1.8
 - preferences, 3.7.1
- box, 3.7.7, 5.8.15
- browse, 7.3.31
 - mode, 7.3.31
 - molt, 9.2
- build, 5.10.7.1
- buttons, 6.14
- bye, 2.5.1.19
 - alpha, 5.1.10
 - trace, 5.1.10
- ca-trace, 5.1.10
- cache, 6.14.1
- calculate, 7.10
 - properties, 7.10
- carboxylic acid, 7.14
- cavities, 4.5
 - closed, 4.5.4
- cell, 4.3.2
- center, 2.5.3.20, 3.1.3, 5.12, 5.12.5, 8.1.39
 - and representative members, 8.7.2
- change height of all rows, 8.1.6
 - row height, 8.1.6
 - selection, 3.6.7
 - speed range, 5.10.7.2
- charge, 2.5.3.21, 5.8.2, 7.4.3, 7.5.1

- export excel, 7.2.3
- save, 7.2
 - 3D, 7.2.5
 - editor, 7.2.4
 - image, 7.2.6
 - table, 7.2.2
 - view, 7.3.28
- chembl, 3.2.3, 3.2.4
- chemical, 7, 7.3.28, 7.3.30, 7.3.31, 7.3.34, 7.3.35, 7.4.10, 7.7, 7.9.4, 7.10.2, 7.16.1, 7.18, 7.29.4, 7.29.5, 8.7.1, 10.4.4
 - clustering, 7.22, 7.22.6
 - dictionary, 7.4.4, 7.4.5, 7.4.6
 - draw, 10.4.1
 - spreadsheet tutorial, 10.4.1
 - edit buttons, 7.4.11
 - editor, 7.4, 7.4.8
 - fragments, 7.3.33
 - group, 7.4.5
 - groups, 7.4.5, 7.4.8
 - modifiers, 7.29.2
 - properties, 10.4.4
 - right click, 7.4.3
 - search, 7.5
 - filter, 7.5.2
 - text, 7.5.4
 - sketch, 10.4.1
 - space, 7.24
 - spreadsheet, 3.2.3, 7.1.3, 7.3.1, 7.4.14, 10.4.1
 - compare, 7.3.22
 - template, 7.3.2
 - spreadsheets, 7.3
 - substituent, 7.8
 - substructure, 3.2.1.1
 - table display, 7.3.3
 - tables, 8.2
 - toxicity, 7.10.2
 - append, 7.4.13
 - clustering, 7.22, 7.22.1
 - draw, 7.4.1
 - duplicates, 7.3.21
 - editor, 7.2, 7.2.2, 7.2.4, 7.2.5, 7.2.6
 - load, 7.1
 - merge, 7.26
 - new, 7.4.1
 - properties, 7.3.19
- query, 7.4.3, 7.5.1, 7.5.3
 - read, 7.1
 - save, 7.2, 7.2.2, 7.2.4, 7.2.5, 7.2.6, 7.4.13
 - search, 7.4.3, 7.5, 7.5.1, 7.5.3
 - similarity, 7.4.3, 7.5, 7.5.1, 7.5.3
 - spreadsheet, 7.2, 7.2.2, 7.2.4, 7.2.5, 7.2.6, 7.3
 - structure, 7.4.13
 - table, 7.3, 8.2
- cheminformatics, 7, 7.3
 - tutorials, 10.4
- chemistry, 7.18
 - convert, 7.16
 - pca, 7.23
 - smiles, 7.16.2
 - duplicates, 7.27
 - remove.redundant, 7.27
- chemspace append, 10.4.4.4
 - build visualize, 10.4.4.1
 - compare, 10.4.4.8
 - delete row, 10.4.4.3
 - distinguish, 10.4.4.7
 - export, 10.4.4.5
 - project, 10.4.4.6
 - select, 10.4.4.2
- chi, 5.8.5
- chiral, 7.19
- chirality, 7.19
- clash, 3.7.5, 5.8.14
- classes, 7.3.28
- clear display and planes, 2.5.3.2
 - selection, 3.6.6
 - planes, 2.5.3.2
- click, 3.1.12, 5.11, 5.12
- clip, 5.3.10, 5.13.1
- clipboard, 5.15.3, 8.7.3
- clipping planes, 5
 - tool, 5.13
 - tools, 5.13
- clone, 2.5.1.2
- close, 5.3.3, 5.3.4
 - downstream cluster, 7.22.5
 - cavities, 4.5.14
- cluster, 8.7.1
 - representative.center, 7.22.2
 - clustering, 8.7, 10.4.3
- cns, 7.28
- collada, 2.6.6, 5.3.7
- color, 4.5.11, 5.3.2, 5.3.3, 5.3.4, 5.3.9.4, 5.4, 5.4.1, 5.8.2, 5.8.3, 7.3.35, 7.13, 8.1.44, 8.7.4
 - background, 5.4.2
 - by, 5.4

- surface by proximity, 5.3.3
 - selection, 5.3.4
- table, 7.3.27
- 2D sketch, 7.5.5.5
- background, 2.5.3.18, 5.4.2
- distance, 5.8.10
- mesh, 5.3.9.3
 - table, 7.3.27
- coloring, 5.4.1
- coloumn, 8.1.24
- column, 8, 8.1.21, 8.1.38, 8.1.39, 8.4, 8.4.1
 - annotation, 8.1.40
 - order, 8.1.28
 - row width, 8.1.21
 - statistics, 8.1.31
 - visibility order, 8.1.27
- color, 8.1.9
 - hide, 7.3.8
 - show, 7.3.8
- combinatorial chemistry, 7.29
 - library, 10.4.8
- combine, 2.5.10.5
 - display style, 3.7.9
- compact tree, 7.22.5
- compare, 7.3.29, 7.25, 7.26
 - table, 7.3.22
 - tables, 7.25
- compatible, 2.5.1.10
- complex, 7.6
- compound, 3.2.1.3, 7.18, 8.2
- compress, 3.7.6
- conditions, 7.5.2
- conformational entropy, 7.21
- connect, 5.3.9.1, 5.12, 5.12.7
 - object, 5.12.7
- connectivity, 7.4.3, 7.5.1
- construct, 2.5.1.1, 5.10.7.1
 - molecule, 2.5.1.1
 - object, 2.5.1.1
- contact, 4.5, 4.5.3, 10.3.5
 - surface, 5.3.2
- contacts, 5.3.3, 5.3.4, 7.6
- contour, 4.3.6, 4.3.7
- convert, 4.1.2, 7.16.4
 - chemical, 7.3.24
 - 3D molecular editor, 7.4.16
 - local database, 2.5.1.6
 - pdb, 10.3.2
 - local.database, 2.5.1.6
 - smiles, 7.16, 7.16.2, 7.16.3
 - converting pdb, 4.1.2
 - coordinates, 7.1.3
 - copy, 7.3.25, 7.4.11, 7.4.17, 7.5.5.2, 8.1.34
 - cell, 8.1.35
 - chemical, 7.3.25
 - paste row, 8.1.34
 - row, 8.1.35
 - rows, 8.1.43
 - selection to table, 8.1.36
 - chemical, 7.3.16
- cpk, 5.1.5
- crash, 2.5.2.11
- creat, 6.6.1
- create, 8.1.1
 - markush, 7.29.3
 - new objects, 3.3
- cross section, 5.13
- crystal, 4.3.2
- crystallographic analysis, 4.3
 - biomolecule, 4.3.3
 - contour map, 4.3.6
 - convert2grid, 4.3.7
 - crystallographic cell, 4.3.2
 - load eds, 4.3.4
 - maps cell, 4.3.5
 - symmetry packing, 4.3.1
 - tools, 10.3.8
 - cell, 2.5.5
 - neighbor, 4.3.1
 - neighbors, 2.5.5
- crystallography, 4.3.4, 4.3.6, 4.3.7
- csv, 7.2.3, 8.1.2, 8.1.3, 8.1.20
- current.slide, 6.13
- curves, 8.4.5
- custom, 5.12, 7.3.3
 - actions, 8.1.39
 - fragments, 7.12
 - label, 5.8.8
 - rotation, 5.12.2
- cut, 8.1.34
- database, 7.9, 7.29.4, 9.1
- decompose.library, 10.4.9
- decomposition, 7.29.4, 7.30.1, 8.4.23
- default, 3.1.13

- all, 2.5.2.2
- column row, 8.1.37
- label, 5.8.9
- all, 2.5.2.2
- angle.label, 5.9.4
- column, 8.1.37
- distance.label, 5.9.4
- label, 5.8.9
- row, 8.1.37
- selection, 2.5.2.1
- dendrogram, 7.24.1
- density, 4.3.4, 4.3.6, 4.3.7
- depth, 5.3.12, 5.10.5
- dialog, 6.6.5
- diffuse, 2.6.2
- dihedral, 4.5.8, 5.8.5
 - angle, 4.5
- directories preferences, 3.7.2
- directory, 3.7
- display ligand receptor interaction, 7.6
- display, 3.1.4, 3.1.13.1, 3.7, 4.2.3, 4.2.3.1, 4.2.3.2, 5.8.14, 5.14, 7.19
 - delete distances, 5.9.4
 - dihedral, 5.9.3
 - distance restraints, 5.8.13
 - distance2, 5.9.1
 - angles, 5.9
 - formal charge, 5.1.9
 - gradient, 5.8.16
 - hydrogen, 5.1.7
 - mesh, 5.3.5
 - meshes, 5.3.8
 - planar angle, 5.9.2
 - tab, 2.6.1
 - tether, 5.8.12
 - toggle, 5.8.15
 - CPK, 5.1.5
 - angle, 5.9.2
 - chemical, 7.3.3
 - dihedral.angle, 5.9.3
 - distace, 5.8.10
 - distance, 5.8.13, 5.9.1
 - electrostatic, 2.5.3.21
 - energy.gradient, 5.8.16
 - hydrogen, 5.1.7
 - polar, 5.1.7
 - macroshape, 5.3.6
 - meshes, 5.3.5

- and
- display.macroshape, 2.6.6
 - molecule, 7.3.24
 - origin, 5.8.11
 - potential, 2.5.3.21
 - representations, 2.6.1
 - restraints, 5.8.13
 - ribbon, 5.1.3
 - skin, 5.1.4
 - surface, 5.1.6, 5.3.1
 - surfaces, 2.6.6
 - table, 7.3.3
 - tethers, 5.8.12
 - wire, 5.1.1
 - xstick, 5.1.2
- distance, 4.5, 4.5.6, 5.8.10, 5.9, 7.25
 - label, 3.7.7
- distances, 2.6.3
- diverse set, 8.7
- docking, 4.5.13
- document, 6.6.4, 6.6.5
 - navigation, 6.6.7
- documents, 5.15.3
- donator, 7.4.9
 - envelope, 2.6.1
 - surface, 3.7.5
- dotted line, 5.1.3
- double, 7.4.10
- doublet, 7.4.7
- drag, 3.1.11, 3.7.7, 5.8.3, 6.6.4
 - residue label, 2.5.3.16
- draganddrop, 3.1.11
- draw, 7.4.17, 7.29.5
 - chemical, 7.4.1
- drop, 3.1.11, 6.6.4
- drug, 7.10
 - bank, 3.2, 3.2.8, 7.1
- drugbank, 7.1
- druglikeness, 7.4.9
- dsPocket, 3.1.8
- easy rotate, 2.5.3.12
- edit, 4.2.3.1
 - chemical moledit, 7.3.26
 - ligand tools, 2.5.2.17
 - menu, 2.5.2
 - molecular document, 6.6.1
 - molecule, 7.4
 - molt, 9.3

- slide, 6.4.1
- table row, 8.1.23
- molecule, 7.3.26
- structure, 7.3.26
- editpdbsearch, 2.5.2.12
- eds, 4.3.4, 4.3.6, 4.3.7
- electron, 4.3.4, 4.3.6, 4.3.7
 - denisty map, 4.3.5
 - densitry map.contour, 2.5.5
 - map, 2.5.1.7, 2.5.5,
- 4.3.4, 4.3.6
- electrostatic potential, 2.5.3.21
 - surface, 5.3
- electrostatics, 5.3.1
- elegant sketch, 5.10.4
- element, 7.4.10
- embed browser, 6.11
 - powerpoint03, 6.8
 - powerpoint07, 6.9
 - powerpoint10, 6.10
 - activeicm, 6.13
- script, 6.13
- browser, 6.7, 6.11
- firefox, 6.7, 6.11
- internet.explorer, 6.7, 6.11
- microsoft, 6.7
- powerpoint, 6.7, 6.8, 6.9, 6.10
- energy, 4.5.11, 5.8.14, 7.21, 7.21.2
- entropy, 7.21.1
- enumerate formal charge states, 7.15
 - reaction, 10.4.10
- enumeration, 7.29.4
- eps, 7.2.6
- eraser, 7.4.11
- exact, 7.25
- excel, 7.2.3
- exclude fragment, 7.5.2
- exit, 2.5.1.19
- explicit, 7.3.28
- export, 4.5.10
- extra windows, 5.2
- extract, 3.4.2, 7.1.3
 - 2D, 7.1.1
 - 3d coordinates to
- spreadsheet, 7.1.3
 - icb, 2.5.1.5
 - object icb, 3.4.2
 - icb, 2.5.1.5
- pharmacophore, 7.5.5.4

- file, 2.5.1.3
 - close, 2.5.1.13
 - compatible, 2.5.1.10
 - export, 2.5.1.12
 - high quality image, 5.15.1
 - load, 2.5.1.7
 - menu, 2.5.1
 - password, 2.5.1.11
 - preferences, 2.5.1.16
 - quick image, 2.5.1.14
- icb, 3.1.10
 - recent, 2.5.1.17
 - bak, 2.5.2.11
- filter, 9.2
 - selection, 3.6.8
- find chemical, 7.3.32
- fit, 7.3.34
- fitting, 8.4.15
- flexibility, 4.5.12
- fog, 2.5.3.5, 5, 5.10.1
- font, 3.7, 3.7.7, 4.2.3.1, 5.8.2, 5.8.3, 7.3.28, 8.1.39, 8.7.4
 - preferences, 3.7.7
- form view, 8.1.5
- formal charge, 5.1.9, 7.14, 7.15
- format, 8.1.2, 8.1.39
- formula, 7.4.9, 7.10
- fragment, 7.3.35, 7.30.1
- fragments, 7.7
- free radical, 7.4.7
- freeze column, 8.1.29
 - row, 8.1.30
- frequency, 7.3.35
- front, 5.3.10, 5.13.1
- full scene antialias, 2.5.3.10
 - screen, 2.5.3.8
- function, 8.1.25, 8.1.31
- functional.groups, 7.12
- general preferences, 3.7.5
- generalselecttools, 3.6.1
- generator, 4.3.3
- getting started, 3
- glasses, 5.6
- google, 2.5.1.7
 - objects, 5.3.7
 - 3D, 2.6.6, 5.3.7
- graphical display tutorial, 10.1
 - 2D3D labels,
- 10.1.4

- color representation, 10.1.1.1
- labels, 10.1.3
- graphics, 3.1
 - controls, 5
 - effects, 5.10
 - panel, 5.2
 - preferences, 3.7.3
 - shadow, 2.5.3.13, 5.10.2
- grid, 7.3.3
- grob, 3.7.5, 4.3.4, 4.3.6, 4.3.7, 5.3
- group, 7.30.1
 - column, 8.1.45
- groups, 7.7, 7.10, 7.11
- guanidinium, 7.14
- gui, 3.1.1, 3.7.4
 - menus, 2.5
 - preferences, 3.7.4
 - tabs, 2.6
- h-bond, 4.2.3, 4.2.3.1, 4.2.3.2
- halogen, 7.10.1
- hardware stereo, 2.5.3.7
- hbond, 4.2, 10.3.6
- header, 3.2.1.6, 8.4.8
- health, 4.5.11
- heatmap, 8.4.6
 - example, 8.4.6.1
- help, 1
 - videos, 1
- hetero, 7.3.28
- hide, 8.1.38
 - column, 8.1.27
- high, 2.5.1.15
 - quality, 2.5.3.11
- highlight new data, 7.3.7.1
- histogram, 8.4, 8.4.1, 8.4.8, 8.4.10, 8.4.12, 8.4.13, 8.4.14, 8.4.15, 8.4.16, 8.4.17, 8.4.19, 8.4.21
 - bins, 8.4.3
 - options, 8.4.2
 - bin.size, 8.4.2
 - bins, 8.4.3
 - color, 8.4.2
 - source, 8.4.2
 - style, 8.4.2
 - title, 8.4.2
- homology, 3.2.1.2, 3.2.5
- hover, 8.4.24
 - add columns, 7.3.4

- color 2D by ph4, 7.5.5.5
- copy 2D, 7.3.16
 - paste, 7.3.6
- decompose, 10.4.9
- duplicate chemicals, 7.3.21
- edit table, 7.3.17
 - tree, 7.22.4
- excel, 7.3.10
- extract 3D ph4, 7.5.5.4
- filter, 7.3.12
- find replace, 7.3.13
- mark row, 7.3.14
- markush, 10.4.8
 - structure, 10.4.7
- merge tables, 7.3.23
- properties, 7.3.19
- reactions, 10.4.10
- reorder, 7.22.3
- sdf, 7.3.9
- show hide, 7.3.8
- sort column, 7.3.5
- standardize, 7.3.18
- table hyperlinks, 7.3.15
 - print, 7.3.11
 - activeicm, 2.3
 - create molecular documents, 2.3.3
 - slides, 2.3.2
 - getting started, 2.3.1
 - ppt, 2.3.4
 - web, 2.3.5
 - chemical clusering, 7.22.1
 - icm browser convert display
- pocket, 2.1.4
 - distances angles, 2.1.9
 - get started, 2.1.1
- graphical display, 2.1.2
 - effects, 2.1.5
 - images, 2.1.7
 - labels
 - annotation, 2.1.6
 - pro
 - crystallographic tools, 2.2.6
 - get started, 2.2.1
 - graphics, 2.2.2
 - plots, 2.2.8
 - sequence
 - analysis, 2.2.7
 - structure
 - analysis, 2.2.3
 - superimpose, 2.2.5
 - surfaces, 2.2.4

cluster center, 7.22.2

selections, 2.1.3

- search, 3.2
 - use gui, 3.1
- html, 2.5.1.12, 3.3, 6.6.1, 6.6.7
- hybridization, 7.4.3, 7.5.1
- hydrogen, 4.2.3, 4.2.3.1, 4.2.3.2, 5.1.8, 7.4.3, 7.5.1, 10.3.6
 - bond, 4.2, 5.1.8, 7.6, 10.3.6
 - label edit, 4.2.3.1
 - move, 4.2.3.2
 - bonds, 4.2.4
 - bond, 7.4.9
- hydrogens, 7.3.28
 - remove, 7.3.18
- hyperlink, 6.6.1, 6.6.2, 8.1.39
- iSee, 2.5.1.5, 2.5.1.12, 3.1.10, 5.15.3, 10.2
- icb, 3.4.2, 3.5
 - chemist howto chemical search, 2.4.3
 - cluster, 2.4.5
 - combi library, 2.4.7
 - ph4, 2.4.4
 - plots, 2.4.8
 - sketch, 2.4.1
 - spreadsheets, 2.4.2
 - stereoisomers
- tautomers, 2.4.6
 - tutorials, 2.4
 - object, 4.1, 10.3.2
 - script, 8.1.39
- icmPocketFinder, 4.5.14
- icmjs, 6.16
- icmpocketfinder, 10.3.7
- id, 8.1.26
- identity, 3.2.1.2
- image, 3.1.14, 3.7, 3.7.5, 5.15.3, 6.6.3, 7.2, 7.2.6, 8.4.20
 - advanced, 5.15.3
 - preferences, 3.7.6
 - multiple, 2.5.1.7
 - quality, 2.5.3.11
 - quick, 2.5.1.14, 5.15.2
- images, 5.15
- inchi, 7.16.2
- increment, 8.1.26
 - id, 8.1.26
- insert, 6.6.4
 - column, 8.1.25
 - image, 6.6.3, 8.1.33
 - table, 8.1.33
 - row, 8.1.32
 - script, 6.6.4
- install, 7.9.1
- interaction, 4.5.3, 7.6
- interactive, 10.2
- interrupt, 5.10.7.3
 - animation, 5.10.7.3
- invert selection, 8.1.22
- isee, 6.6.5
- isis, 7.4.17
- isotope, 7.4.3, 7.5.1
- iupac, 7.2.7, 7.3.20
- javascript, 6.16
- join, 7.26
- jpg, 5.15
 - means, 8.7.1
- key chemical, 7.4.10
- keyboard mouse, 5.11
- keystrokes in chem-edit, 7.4.10
- kmz, 2.6.6, 5.3.7
- label, 3.7.7, 8.7.4
 - atoms, 5.8.2
 - color, 5.8.7
 - move, 5.8.4
 - residues, 5.8.3
 - sites, 5.8.6
 - variables, 5.8.5
- 2D, 2.6.3
- 3D, 2.6.3, 5.8.1
 - atom, 5.8.1
 - atoms, 5.8.2
 - color, 5.8.7
 - custom, 5.8.8
- delete, 5.8.1, 5.8.9
- distance, 5.8.10
- drag, 2.5.3.16
- move, 2.5.3.16, 5.8.4
- residue, 5.8.1
- residues, 5.8.3
 - site, 5.8.1
 - sites, 5.8.6
 - variable, 5.8.1
 - variables, 5.8.5
- labeling, 5.8.1
- labels, 5.8, 7.3.28
 - distances, 5.8.10
 - tab, 2.6.3
- landscape, 3.7.6
- large chemical space, 10.4.4

- layer, 5.14
- layers, 5.14
- learn, 7.17, 8.6
- least.squares, 8.4.15
- library, 7.29.4
 - reaction, 10.4.10
- ligand, 4.2.2, 7.6, 7.21, 7.21.1, 7.21.2
 - code, 3.2.1.3, 3.2.7
 - editor preferences, 2.5.2.18
 - energetics, 7.21
 - conformational
- entropy, 7.21.1
 - strain, 7.21.2
 - pocket, 4.2.4
 - receptor display, 4.2
 - interaction, 7.6
 - surface, 4.2.2
 - pocket, 3.1.8
 - receptor.contact, 4.5.3
- ligand_pocket_interactions, 4.2.4
- ligedit tab, 2.6.5
- light, 2.6.2
 - tab, 2.6.2
- lighting, 5.3.9.4, 5.5
- likeness, 7.10
- line, 3.7.5, 8.7.4
- lineWidth, 3.7.3
- links, 3.6.20
- linux, 7.9.1
- lipinski rule, 7.28
- list, 3.6.18
- load, 2.5.1.3, 2.5.1.17, 4.3.4, 4.3.6, 4.3.7
 - nmr model, 3.2.1.4
 - protein structure, 4.1.1
- local databases, 9
 - database.browse, 9.2
 - edit, 9.3
 - query, 9.4
 - row, 9.3
- lock, 5.3.10, 5.13.1, 7.3.31
- log, 8.4.10
- logP, 7.4.9, 7.10
- logS, 7.4.9, 7.10
- logarithmic, 8.4.10
- logout, 2.5.1.19
- mac, 7.9.1
- macros, 6.14
- macroshape, 2.5.3.22, 5.3, 5.3.6
- make, 5.10.7.1, 8.1.1
 - animation, 5.10.7.1
 - molecular document, 6.6
 - molt, 9.1
 - selection, 3.6
 - molecule, 2.5.1.1
 - object, 2.5.1.1
- making molecular slides, 6.1
 - html, 6.6
 - color, 8.4.13
- map, 3.7.7, 4.3.4, 4.3.6, 4.3.7
 - cel, 4.3.5
- mark, 8.1.44
 - row, 8.1.44
 - shape, 8.4.12
 - size, 8.4.12
- markush, 7.22.7, 7.29.1, 7.29.3, 7.30.1
 - library, 10.4.8
- matched pair, 7.30.5, 10.4.11
 - analysis, 7.30.5
- materials, 2.6.6
- max, 8.7.1
- maxColorPotential, 3.7.10
- maximum common substructure, 7.22.6, 7.24, 7.24.1
 - dendrogram, 7.24.1
- mcs, 7.22.6, 7.24.1
 - rgroup decomposition, 7.22.7
- memory, 7.1.2
- menu, 6.6.5
 - chemistry, 2.5.14
 - docking, 2.5.15
 - homology, 2.5.13
 - molmechanics, 2.5.16
 - tools chemical search, 2.5.11
 - molecular editor, 2.5.12
 - windows, 2.5.17
- merge, 7.26
 - two sets, 7.26
- mesh, 4.2.1, 4.2.2, 4.3.4, 4.3.6, 4.3.7, 5.3, 5.3.9.1, 5.3.9.2, 5.3.9.4, 5.3.10, 5.3.11, 5.3.12, 5.13.1
 - clip, 5.3.10
 - color lighting, 5.3.9.4
 - options, 5.3.9
 - representation, 5.3.9.3
 - save, 5.3.11
 - options, 5.3.9
- meshes, 5.3.2, 5.10.5
 - surfaces grobs, 5.3

- min, 8.7.1
- mmff, 7.4.16
 - type, 5.8.2
- mmp, 10.4.11
- mnSolutions, 3.7.10
- mol, 7.2, 7.2.2, 7.2.4, 7.2.5, 7.2.6, 7.4.13
- mol2, 7.2, 7.2.2, 7.2.4, 7.2.5, 7.2.6
- molcart, 7.9, 7.9.1, 7.9.2, 7.9.3, 7.9.4, 7.9.5, 9
 - add database, 7.9.3
 - administration, 7.9.5
 - installation, 7.9.1
 - search, 7.9.4
 - start, 7.9.2
- molecular, 7.3.30, 7.3.31, 7.3.34, 7.3.35
 - animations slides, 6
 - documents, 10.2
 - graphics, 5
 - matched pairs, 10.4.11
 - table, 7.16.1
 - weight, 7.4.9
 - editor, 7.4
- moledit, 7.4.8
- molskin, 5.3.2
- molt, 9, 9.4
- monochrome, 7.3.28
- mouse, 3.1.3, 5.11, 5.12
- mov, 5.16, 5.16.2
- move, 2.5.3.19, 3.1.11, 3.1.13, 4.2.3.2, 5.3.9.1, 5.3.9.2, 5.12, 5.12.7
 - column, 8.1.27
 - mesh, 5.3.9.2
 - slide, 6.4.2
 - structure, 5.12
 - tools, 5
 - rotate, 5.11
 - slab, 5.11
 - translate, 5.11
 - z-rotation, 5.11
 - zoom, 5.11
- movie, 5.16.1
 - making, 5.16, 5.16.2
 - open, 5.16, 5.16.2
- mpa, 10.4.11
- mpeg, 5.16, 5.16.1, 5.16.2
- mpg, 5.16, 5.16.2
- mpo, 7.28
- multi panel, 5.2
 - parameter optimization, 7.28
- windows, 5.2
- multiple receptor, 3.2.2
- navigate workspace, 3.6.10
- new icm session, 2.5.1.2
 - table, 8.1.1
- table, 8.1.1
- nmr model, 3.2.1.4
- nof, 7.10.1
 - chemical, 7.10.1
- non-contiguous selection, 3.6.18
- number of sp³, 7.10.1
- numbers, 7.3.28
- object, 3.1.11, 3.5, 10.3
- objects, 4.1.2
 - in table, 8.3
 - in.table, 8.3
- occlusion, 5.3.12, 5.10.5
 - shading, 5.3.12
 - effect, 5.10.5
- occupancy, 5.1.3, 10.3.10
 - display, 3.2.1.5
- oda, 4.5.13
- older version, 2.5.1.10
- omega, 5.8.5
- open, 2.5.1.3, 3.4, 8.1.2
 - file, 3.4
 - password, 3.4.1
- with password, 2.5.1.4
- movie, 5.16, 5.16.2
 - password, 2.5.1.4, 3.4.1
- optimal, 4.5.13
- orange, 3.6.5
 - selection, 3.6.5
- origin, 5.8.11
- other selection, 3.6.19
- overlay, 10.3.3
- package.activeicm, 6.13
- packing, 4.3.1
- password, 7.9.5
- paste, 7.4.11, 7.4.17, 8.1.34
- pca, 8.5
- pdb, 2.5.1.7, 3.2, 3.2.1.1, 3.2.7, 3.5, 10.3
 - html, 3.2.1.6
 - preparation, 10.3.11
 - search, 3.2.1, 3.2.1.2, 3.2.1.3, 10.3.1
 - recent, 2.5.1.18
 - search, 2.6.4, 3.1.2

pdbsearchhomology, 2.5.2.15
 pdbsearchidentity, 2.5.2.14
 pdbsearchsequence, 2.5.2.16
 peptide, 3.3
 perspective, 2.5.3.9, 5.10.6

 ph4, 7.5.5
 draw 2d, 7.5.5.1
 3d, 7.5.5.2
 search, 7.5.5.3
 pharmacophore, 7.3.35, 7.5.5.5
 2D, 10.4.6
 3D, 10.4.5
 clone, 7.5.5.2
 draw2D, 7.5.5.1
 draw3D, 7.5.5.2
 edit, 7.5.5.1, 7.5.5.2
 move, 7.5.5.2
 new, 7.5.5.2
 search, 7.5.5, 7.5.5.3,
 10.4.5, 10.4.6
 phi, 5.8.5
 picking, 5
 picture, 2.5.1.14, 3.1.14,
 5.15.2, 6.6.3
 tips, 3.1.14
 chart, 8.4.7
 pka, 7.14
 planar, 4.5.7, 5.8.5
 angle, 4.5
 angle, 5.9.2
 plane, 5.3.10, 5.13, 5.13.1,
 5.14
 plot, 3.7, 3.7.8, 8.4, 8.4.1,
 8.4.4, 8.4.8, 8.4.10, 8.4.12,
 8.4.13, 8.4.14, 8.4.15, 8.4.16,
 8.4.17, 8.4.19, 8.4.20, 8.4.21
 R group sar, 7.30.3
 axis, 8.4.10
 color, 8.4.13
 function, 2.5.9, 2.5.9.1
 grid, 8.4.14
 header, 8.4.8
 inline, 8.4.21
 logarithmic, 8.4.11
 mark, 8.4.12
 point label, 8.4.18
 preferences, 3.7.8
 groups, 8.4.23
 regression, 8.4.15
 selection, 8.4.17
 zoom translate, 8.4.16
 axis, 8.4.14
 display, 8.4.14
 grid, 8.4.14
 inline, 8.4.21
 logarithmic, 8.4.11
 pls, 7.17, 8.6
 png, 2.5.1.14, 5.15, 5.15.2,
 6.6.3, 7.2, 7.2.6
 pocket, 3.1.8, 4.2, 4.2.1,
 4.2.2, 4.5.14, 10.3.7
 surface, 4.2.1
 peptide, 3.1.8
 properties, 3.1.8
 pocketome, 3.2, 3.2.2
 point label, 8.4.18
 portait, 3.7.6
 postscript, 3.7.6
 powerpoint, 10.2
 ppt, 6.12, 6.14
 predict, 7.17, 8.6
 preferences, 3.7
 presentatio, 6.6.5

 presentation, 6.7, 6.12
 presentations, 6
 press-and-hold to rotate, 7.4.8
 primary aliphatic amines, 7.14
 principal component analysis,
 8.5
 print, 5.7, 8.4.19, 8.7.3
 plot, 8.4.19
 printer.resolution, 3.7.6
 pro-drug, 7.20
 prodrug, 7.20

 project, 2.5.1.5, 10.4.4.6

 close, 2.5.1.13
 rename, 2.5.1.9
 properties, 5.8.2, 7.10
 property, 7.4.9
 monitor, 7.4.9
 protect, 6.6.8
 protein, 4.4.6
 health, 4.5.11
 structure, 4
 analysis, 4.5
 closed cavities,
 4.5.4
 contact areas,
 4.5.3
 distance, 4.5.6
 find related
 chains, 4.5.1
 finding dihedral
 angle, 4.5.8
 planar
 angle, 4.5.7
 rama export,
 4.5.10
 ramachandran
 plot, 4.5.9

- surface area,
- 4.5.5
 - tutorials, 10.3
 - analysis, 10.3.4
 - contact area,
- 10.3.5
 - convert, 10.3.2
 - hydrogen bond,
- 10.3.6
 - icmpocketfinder,
- 10.3.7
 - search, 10.3.1
 - superimpose,
- 10.3.3
 - superposition, 4.4
 - select, 4.4.1
 - sites by apf, 4.4.6
 - superimpose 3D, 4.4.3
 - grid, 4.4.5
 - multiple
 - proteins, 4.4.4
 - protein-protein, 4.5.13
 - proximity, 5.3.3, 5.3.4
 - psa, 7.4.9
 - psi, 5.8.5
 - pubchem, 7.1
 - publication quality images, 5.3.2
 - pubmed, 3.2.1.7
 - purple box, 2.5.3.23
 - qs hydrogen bond, 4.2.3
 - qsar, 7.17
 - predict, 7.17
 - quality, 2.5.1.15, 3.7.5
 - query molt, 9.4
 - processing, 7.5.3
 - setup, 7.5.1
 - quick, 3.1.14
 - image, 5.15.2
 - start move structure, 3.1.3
 - read pdb, 3.1.2
 - representation, 3.1.6
 - selection, 3.1.5
 - level, 3.6.3
 - what is selected,
- 3.6.4
 - display.distance, 5.9.1
 - start color, 3.1.7
- quit, 2.5.1.19
 - group, 7.22.7, 7.29.4
 - table, 7.29.2
 - groups, 7.29.2
- r-group, 7.22.7, 7.29.2
 - decomposition, 7.22.7
 - enumeration, 7.22.7
- r-groups, 8.4.23
- racemic, 7.3.28, 7.16.4
- rainbow, 3.7.5, 5.8.15, 7.3.35
- ramachandran plot, 4.5, 4.5.10
- range, 5.10.7.2
- ratio.selection, 3.7.5
- reactions, 7.7, 7.29.5
- reactivity, 7.10.2
- read, 2.5.1.3, 2.5.1.17, 3.4, 7.3.1
 - chemical, 7.1
 - spreadsheet, 7.3.1
 - table, 8.1.2
 - pdb, 3.1.2
 - table, 8
- reagent, 7.29.5
- rear, 5.3.10, 5.13.1
- recent files, 2.5.1.17
 - pdb codes, 2.5.1.18
- receptor, 4.2.1, 4.2.2, 7.6
- recover, 2.5.2.11
- redo, 2.5.2.10, 7.4.11
- regression, 8.4.15
- relationship, 8.6
- remove.explicit.hydrogens, 7.11
 - salt, 7.11
- rename, 8.1.24
 - column, 8.1.24
 - project, 2.5.1.9
- reorder column, 8.1.28
- replace chemical, 7.3.32
- representation, 2.5.3.19
- residue, 3.7.7
 - alternative orientaiton, 10.3.11
 - range, 3.6.18
 - content, 2.5.4
- residues, 4.2.1, 4.2.2
- resize, 5.3.9.1, 5.15.3
 - mesh, 5.3.9.1
- resolution, 3.2.1.3
- restore, 2.5.2.11, 5.3.10, 5.13.1
 - recent backup, 2.5.2.11
- rgroup, 7.29.4
- ribbon, 2.6.1, 3.7.9, 5.1.3
 - preferences, 3.7.9
 - style, 3.7.9
 - breaks, 5.1.3
 - cyinders, 5.1.3

- worm, 5.1.3
- ribbonColorStyle, 3.7.9
- right, 3.1.12
 - click, 3.1.12
- ring, 7.4.3, 7.4.6, 7.5.1
- rings, 7.3.28
- rmsd, 4.5, 4.5.2
- rock, 2.5.3.15, 5.10.7, 5.10.7.1, 6
 - speed, 5.10.7.2
- root mean square deviation, 4.5.2
- rotate, 2.5.3.15, 3.1.3, 5, 5.10.7, 5.10.7.1, 5.12, 5.12.1, 5.12.2, 6, 7.3.34
 - chemical, 7.3.34
 - when pasting, 7.4.8
 - easy, 2.5.3.12
 - speed, 5.10.7.2
- rotating fragment in editor, 7.4.8
- rotation, 5.12.1
- row, 8, 8.1.21, 8.1.34, 8.1.44
 - flag, 8.1.12
 - height, 8.1.6
 - mark, 8.1.12
 - hide, 7.3.8
 - show, 7.3.8
- ruler, 5.8.15
- rxn, 7.4.13
- sali, 7.30.4
 - bridge, 10.3.6
- salts, 7.3.18
- sar, 7.22.7, 7.30, 8.4.23
 - analysis, 7.30
 - table, 7.30.2
- save, 3.5, 5.3.11, 5.10.7.4, 7.2.3, 8.4.20, 8.7.3
 - SMILES, 7.4.15
 - chemical mol, 7.4.13
 - spreadsheet workspace, 7.2.1
 - to chemical spreadsheet, 7.4.14
 - file, 3.5
 - image plot, 8.4.20
 - object, 3.1.9
 - pdb, 3.5
 - project icb, 3.1.10
 - slide, 6.4
 - smiles string, 7.4.15
 - table, 8.1.20
 - tree, 8.7.3
 - sdf, 7.4.14
 - image, 2.5.1.15, 3.1.14
 - object, 3.1.9
 - password, 2.5.1.11
 - picture, 2.5.1.15
 - project, 2.5.1.8, 2.5.1.9, 2.5.1.10, 3.1.10
 - table.view, 8.1.7
 - saving, 2.5.1.8
 - project, 2.5.1.8
 - scaffold, 7.13
 - scale, 3.7.5
 - screenshot, 5.16, 5.16.2
 - movie, 5.16.2
 - script, 3.3, 6.6.4, 6.6.5
 - sdf, 7.2, 7.2.2, 7.2.4, 7.2.5, 7.2.6, 7.3.35, 7.9, 7.9.3, 9.1
 - search, 7.9, 7.9.4, 9.2
 - chembl, 3.2.3
 - drugbank, 3.2.8
 - filter, 7.5.2
 - in workspace, 2.5.2.4
 - pdb, 3.2.1
 - chemical, 3.2.1
 - ligand code, 3.2.7
 - pocketome, 3.2.2
 - pubchem, 3.2.9
 - surechembl, 3.2.4
 - tab field, 3.2.1.3
 - pdb chemical, 3.2.1.1
 - sequence, 3.2.1.2
 - tautomer, 7.5.3
 - uniprot, 3.2.6
 - in workspace, 2.5.2.4
 - secondary aliphatic amines, 7.14
 - structure, 2.5.4, 5.1.3
 - select, 3.6.12, 3.6.13, 8, 8.1.44
 - a tree branch, 8.7.2
 - all, 3.6.14
 - amino acid, 3.6.13
 - duplicates, 7.27
 - molecule, 3.6.12
 - neighbors, 3.6.15
 - graphic, 3.6.16
 - object, 3.6.11
 - residue, 3.6.13, 3.6.18
 - by number, 3.6.18
 - number, 3.6.18
 - tree, 8.7.2
 - atom, 3.1.5, 3.6.3
 - graphical, 3.1.5, 3.6.3

- purple.box, 2.5.3.23
- residue, 3.1.5, 3.6.3
- workspace, 3.1.5, 3.6.3
- selectall, 2.5.2.3
- selecting.neighbors, 3.6.16
- selection, 3.6.4, 3.6.5, 3.6.21, 5.3.4, 7.4.11, 8.4.17, 8.7.2, 8.7.4
 - clear, 2.5.2.7
 - neighbors, 2.5.2.8
 - alignment, 3.6.19
 - all, 2.5.2.3
 - alter, 3.6.7
 - atom, 2.5.2.5
 - basic, 3.6.2
 - change, 3.6.7
 - clear, 2.5.2.7
 - column, 8.1.22
 - filter, 2.5.2.5, 3.6.8
 - graphical, 3.6.16
 - invert, 2.5.2.6, 8.1.22
 - level, 2.5.3.3
 - mode, 2.5.3.4
 - near atoms, 2.5.2.8
 - neighbors, 2.5.2.5, 2.5.2.8, 3.6.15, 3.6.17
 - object, 3.6.11
 - other, 3.6.19
 - properties, 2.5.2.5
 - range, 8.1.22
 - residue, 2.5.2.5
 - row, 8.1.22
 - sphere, 3.6.15
 - spherical, 2.5.2.8
 - superposition, 4.4.1
 - table, 3.6.19, 8.1.22
 - elements, 8.1.22
 - tools, 3.6.1, 3.6.2, 3.6.7, 3.6.8
 - whole, 3.6.11
 - workspace, 3.6.9, 3.6.17
- selectioninvert, 2.5.2.6
- selections, 3.6
- selectneighbors workspace, 3.6.17
 - organized network, 7.24
- sequence, 2.5.4, 3.2, 3.2.1.2, 3.2.5, 3.2.6, 3.3, 10.3
 - pattern, 3.2.1.2
- set, 7.3.31
 - formal charges, 7.14
- shading, 5.3.12
- shadow, 5.10.2
- shell preferences, 3.7.10
- shift, 5.8.3
- shine, 2.6.2, 3.7.5
- shineStyle, 3.7.3
- show, 6.3.1, 8.1.38
 - hide column, 8.1.38
- side, 7.3.29
 - by side, 7.3.29
 - stereo, 2.5.3.6
- sigmaLevel, 4.3.6, 4.3.7
- similarity, 7.25
- single, 7.4.10
- singlet, 7.4.7
- sites, 4.4.6
- size, 4.2.3.1
- sketch accents, 5.10.3
 - markush, 7.29.1
 - smiles, 7.4.12
 - accents, 2.5.3.14, 5.10.3
- skin, 2.6.1, 5.1.4
- slab, 5.3.10, 5.13.1
- slice, 5.13
- slide, 5.10.7.4, 6.2, 6.3.1, 6.6.1
 - effects, 6.5
 - movie, 5.16.1
 - file, 6.2
 - navigation, 6.3.2
 - show, 6.3
 - blend, 6.5
 - edit, 6.4.1
 - effect, 6.5
 - smooth, 6.5
 - transition, 6.5
- slides, 5.16.1, 6, 6.1, 6.3
- smiles, 7.4.9, 7.10, 7.16, 7.16.2, 7.16.3
- smooth, 5.3.9.3
- solid, 5.3.9.3
- sort table, 2.5.10.4
- sorting compounds, 8.7
- sp3, 7.10.1
- spec, 2.6.2
- speed, 5.10.7.2
- split, 7.30.1
- spreadsheet, 7.16.1
- standard table, 8.1
- standardize, 7.11
 - table, 7.11

- stereo, 3.7.6, 5.6, 7.3.28, 7.4.2
 - bond, 7.4.2
 - hardware, 2.5.3.7
 - side-by-side, 2.5.3.6
- stereoisomer, 7.16.4
- stereoisomers, 7.19
- stick, 3.7.5
- stl, 5.7
- stop, 5.10.7.3
- store, 2.5.3.19, 5.10.7.4
 - current view, 2.5.3.19
- strain, 4.5.11, 7.21, 7.21.2
- structure, 4.3.3, 8.6, 10.3
 - analysis, 10.3.4
 - representation, 5.1
 - smiles, 7.16.3
- structures, 7, 7.1
- style, 3.7.5
- substituent, 7.8.1, 7.8.2, 7.29.2
- substructure, 7.9.4, 7.12
 - alerts, 7.12
- superimpose, 2.5.8, 4.4.2, 4.4.6, 10.3.3
 - 3D, 4.4.3
 - Calpha, 4.4.3
 - arrange.grid, 4.4.5
 - backbone, 4.4.3
 - heavy atoms, 4.4.3
 - multiple, 4.4.4
- superposition, 10.3.3
- surface, 2.6.1, 3.7.5, 4.2.1, 4.2.2, 5.1.6, 5.3, 5.3.3, 5.3.4
 - area, 4.5
 - area, 4.5.5
- surfaces, 4.2, 5.3.1, 5.3.2, 5.10.5
- symmetry, 4.3.1, 4.3.3, 10.3.8, 10.3.9
- system preferences, 3.7.11
- tab, 8.1.2, 8.1.20
 - pdb, 2.6.4
- table, 3.3, 7.1.3, 7.3.24, 7.3.25, 7.3.28, 7.3.30, 7.3.31, 7.3.34, 7.3.35, 7.16.1, 8, 8.1.34, 8.1.39, 8.1.44, 8.4, 8.4.1, 8.4.4, 8.4.8, 8.4.10, 8.4.12, 8.4.13, 8.4.14, 8.4.15, 8.4.16, 8.4.17, 8.4.19, 8.7.1
 - alignment, 8.1.11
 - clone, 8.1.15
 - color, 8.1.9
 - column format, 8.1.39
 - copy, 8.1.35, 8.1.36
 - delete, 8.1.16
 - edit, 8.1.23
 - filter, 8.1.42
 - find, 8.1.8
 - replace, 7.3.32
- font, 8.1.10
- grid, 8.1.5
- histogram, 8.4.1
- insert, 8.1.25
- layout, 8.1.5
- learning, 8.6
- mark, 8.1.12
 - row, 8.1.12
- mouse, 8.1.46
- navigation, 8.1.4
- new column, 8.1.25
- plot, 8.4
- print, 8.1.18
- rename, 8.1.14
- rightclick, 8.1.13
- save, 8.1.3
 - selection, 8.1.3
- search, 8.1.8
- select, 8.1.22
- setup, 8.1.17
- sort, 8.1.41
- split fragments, 7.3.33
- view, 8.1.5
 - save, 8.1.7
- zoom translate, 7.3.30
- action, 8.1.46
- alignment, 8.1.11
- append, 8.1.42
- clone, 8.1.15
- color, 8.1.9
- column, 7.3.4, 8.1.25, 8.1.31, 8.1.38
- columns, 7.3.8
- compare, 7.3.22
- copy, 7.3.6
- cursor, 8.1.46
- delete, 8.1.13, 8.1.16
- double.click, 8.1.46
- edit, 7.3.17
- excel, 7.3.10, 8.1.19
- filter, 7.3.12, 8.1.42
- find-replace, 7.3.13
 - to screen, 8.1.4
- font, 8.1.10
- grid lines, 8.1.4
- hide, 8.1.38
- hyperlink, 7.3.15

- join, 2.5.10.5
- label, 7.3.14
- landscape, 8.1.17
- mark, 7.3.14
- merge, 2.5.10.5, 7.3.23, 7.26
 - mouse, 8.1.46
 - name, 8.1.14
 - new, 8.1.1
 - options, 8.1.13
 - orientation, 8.1.17
 - portrait, 8.1.17
 - print, 7.3.11, 8.1.4, 8.1.18
 - read, 8.1.2
 - rename, 8.1.14
 - right click, 8.1.13
 - row, 8.1.32
 - rows, 2.5.10.7
 - save, 7.3.9, 8.1.3, 8.1.4, 8.1.20
 - scale, 8.1.17
 - scroll, 8.1.4
 - sdf, 7.3.9
 - select, 8.1.22
 - setup, 8.1.17
 - sort, 2.5.10.4, 7.3.5, 8.1.41
 - standard, 8.1
 - view, 7.3.29
 - width, 8.1.4
- tables, 7.25, 8
- tag, 3.6.21, 8.1.45
- tags, 3.6.21
- tautomer, 7.18
- tautomers, 7.18
- temperature, 4.5.12
- template, 7.4.6
- templates, 7.4.6
- terminal, 7.3.28
- text, 3.7.7, 6.6, 6.6.1, 6.6.7, 7.3.28, 7.9.4, 8.4.22
 - search, 7.5.4
- texture, 2.6.6
- three, 7.3.24
- threshold, 3.7.5
- tier, 3.1.13
 - racemic, 7.16
- tools 3D, 2.5.6
 - analysis, 2.5.7
 - append rows, 2.5.10.7
 - extras, 2.5.9
 - plot function, 2.5.9.1
 - superimpose, 2.5.8
 - table, 2.5.10
 - Learn, 2.5.10.1
 - clustering, 2.5.10.3
 - merge, 2.5.10.5
 - predict, 2.5.10.2
- tooltip, 8.4.24
 - balloons, 8.4.24
- torsion, 5.12.6
 - angles, 5.12, 5.12.6
- toxscore, 7.10.2
- trace, 5.1.10
- transitions, 6
- translate, 3.1.3, 5, 5.12, 7.3.30
- translation, 5.12.3, 8.4.16
- transparent, 5.3.9.3
 - background, 5.15.3
- tree, 7.22.7, 8.7.2, 8.7.3, 8.7.4
 - distance, 7.22.3
 - edit, 7.22.4
 - reorder, 7.22.3
- triplet, 7.4.7
- tsv, 8.1.20
- tut analyze alternative orientations, 10.3.11
 - occupancy, 10.3.10
 - symmetry, 10.3.9
- tut3e, 10.3.12
- tutorial 2D pharmacophore, 10.4.6
 - 3D pharmacophore, 10.4.5
 - chemical clustering, 10.4.3
 - search, 10.4.2
 - molecular documents, 10.2
- tutorials, 10
- two, 7.3.24
- unclip, 5.3.10, 5.13.1
- undisplay, 3.1.4, 5.1.7
 - origin, 5.8.11
- undo, 2.5.2.9, 3.7, 7.4.11
- uniprot, 3.2.6
- unique, 7.3.28, 7.27
- unit, 4.3.3
- unusual peptide, 3.3
 - activeicm, 6.12
- user, 7.9.5
- user-defined groups, 7.4.5
- uundisplay-all, 2.5.3.1

- variable, 3.7.7
- very large sdf files, 7.1.2
- video, 1, 5.16, 5.16.1, 5.16.2
- view, 2.5.3.19, 6.3.1, 7.3.28
 - animate view, 2.5.3.15
 - center, 2.5.3.20
 - color background, 2.5.3.18
 - fog, 2.5.3.5
 - macroshape, 2.5.3.22
 - menu, 2.5.3
 - mesh clip, 5.13.1
 - perspective, 2.5.3.9
 - selection level, 2.5.3.3
 - mode, 2.5.3.4
 - shadow, 2.5.3.13
 - sketch accents, 2.5.3.14
 - slide show, 6.3.1
 - tools, 2.5.3
 - tree, 8.7.4
 - undisplay all, 2.5.3.1
- virus, 4.3.3
- visualize, 7.24
 - chemical space, 7.24
- volume, 7.4.9
- wavefront, 2.6.6, 5.3.11
- web, 10.2
 - browser, 2.5.1.12
- weight, 7.10
- weighted, 8.7.1
- width, 8.1.21
- window, 3.1.13
- windows, 3.1.13.1, 7.9.1
- wire, 2.6.1, 3.7.5, 5.1.1
- wireBondSeparation, 3.7.1
- workspace, 3.1.4
 - panel, 3.1.4
 - selection, 3.6.9
 - navigation, 3.6.10
- write, 3.1.14, 3.5, 8.4.20
 - excel, 7.2.3
 - image, 2.5.1.15
 - images, 5.15
 - pdb, 3.5
 - image, 2.5.1.15
 - object, 3.1.9
 - picture, 2.5.1.15
 - project, 2.5.1.8, 3.1.10
 - table, 8.1.3
 - ray, 2.5.5
 - xi, 5.8.5
 - xls, 7.2.3
 - xlsx, 7.2.3
 - xstick, 5.1.2
 - youtube, 1
 - zoom, 3.1.3, 5, 5.12, 5.12.4, 7.3.30, 8.4.16