





# Table of Contents

ICM–Chemist User Guide v.3.7–2a.....	1
<b>1 How To Guides and Videos.....</b>	<b>3</b>
1.1 ICM–Browser How To Guide.....	3
1.1.1 Download and Install ICM–Browser.....	3
1.1.2 How to use the Graphical Display.....	3
1.1.3 How to make Graphical Selections.....	5
1.1.4 How to Convert Proteins, Display Hydrogens and Ligand Binding Pocket.....	5
1.1.5 How to change Graphics Effects.....	5
1.1.6 How to add Labels and Annotations.....	6
1.1.7 How to Make High Quality Publication Images.....	6
1.1.8 How to Superimpose Protein Structures.....	6
1.1.9 How to Measure Distances and Angles.....	6
1.2 ICM–Browser–Pro How To Guide.....	7
1.2.1 Download and Install ICM–Browser–Pro.....	7
1.2.2 Graphics.....	7
1.2.3 Protein Structure Analysis.....	7
1.2.4 Surfaces.....	7
1.2.5 Superimpose Proteins.....	8
1.2.6 Crystallographic Tools.....	8
1.2.7 Sequence Analysis.....	8
1.2.8 Plotting Tools.....	8
1.3 ActiveICM How To Guide – Create 3D Molecular Documents for the Web and PowerPoint.....	9
Creating 3D Documents Is Straightforward.....	9
1.3.1 Getting Started.....	9
1.3.2 How to Create a Series of Fully–Interactive 3D Slides.....	9
1.3.3 How to Create Molecular Documents.....	9
1.3.4 How to Display Molecular Documents in PowerPoint.....	10
1.3.5 How to Display Molecular Documents on the Web.....	10
1.4 ICM–Chemist How To Guide.....	10
1.4.1 How to Import, Sketch, and Edit Chemicals.....	10
1.4.2 How to Work with Chemical Spreadsheets.....	11
1.4.3 How to Undertake a Chemical Search.....	12
1.4.4 How to Work with Pharmacophores.....	12
1.4.5 How to Perform Chemical Clustering.....	12
1.4.6 How to Generate Stereoisomers and Tautomers.....	13
1.4.7 How to Generate Combinatorial Libraries.....	13
1.4.8 How to Generate Plots and Histograms.....	13
<b>2 Getting Started.....</b>	<b>15</b>
2.1 How to Use the Graphical Display.....	15
2.1.1 How to load a PDB Structure.....	15
2.1.2 How to Move a Structure in the Graphical Display.....	16
2.1.3 How to use the Graphics window controls.....	17
2.1.4 How to Make Selections.....	17
2.1.5 How to Change the Selection Level and Mode.....	18
2.1.6 How to Check What is Selected.....	19
2.1.7 How to use the ICM Workspace Panel.....	20
2.1.8 How to Display a Molecule.....	21
2.1.9 How to Change Protein Representation.....	23
2.1.10 How to remove chain breaks (dotted lines).....	24
2.1.11 How to Color.....	24
2.1.12 How to Display a Binding Pocket Surface.....	25
2.1.13 How to Save an ICM Object.....	26
2.1.14 How to Save an ICM Project File.....	27
2.1.15 How to Drag and Drop.....	27
2.1.16 How to: Right Click Options.....	27
2.1.17 How to Move Windows.....	27
2.1.18 How to Arrange Windows.....	28
2.1.19 How to Make a Picture.....	29
2.2 Making Selections.....	29
2.2.1 Graphical Selections.....	30
2.2.2 Selection Tools.....	31
2.2.3 Basic Selections.....	31

# Table of Contents

## 2 Getting Started

2.2.4 Clear Selection.....	32
2.2.5 Altering a Selection.....	32
2.2.6 Filter Selection.....	33
2.2.7 Workspace Selections.....	36
2.2.8 Workspace Navigation.....	36
2.2.9 Selecting the Whole Object.....	37
2.2.10 Selecting Amino Acids.....	37
2.2.11 Selecting Neighbors.....	38
2.2.12 Selecting Neighbors: Graphical.....	39
2.2.13 Selecting Neighbors: Workspace.....	40
2.2.14 Alignment and Table Selections.....	41
2.2.15 Making Links.....	41
2.3 Menu Option Guide.....	42
2.3.1 File Menu.....	42
2.3.2 Edit Menu.....	69
2.3.3 View Menu.....	71
2.3.4 Bioinfo Menu.....	76
2.3.5 Tools Menu – Xray.....	76
2.3.6 Tools Menu – 3D Predict.....	77
2.3.7 Tools Menu – Analysis.....	78
2.3.8 Tools Menu – Superimpose.....	80
2.3.9 Tools Menu – Extras.....	80
2.3.10 Tools Menu – Table.....	80
2.3.11 Tools Menu – Chemical Search.....	82
2.3.12 Tools Menu – Molecular Editor.....	82
2.3.13 Homology Menu.....	82
2.3.14 Chemistry Menu.....	82
2.3.15 Docking Menu.....	83
2.3.16 MolMechanics Menu.....	83
2.3.17 Windows Menu.....	84
2.4 Tab Guide.....	85
2.4.1 Display Tab.....	85
2.4.2 Light Tab.....	85
2.4.3 Labels Tab.....	85
2.4.4 PDB Search Tab.....	86
2.4.5 Meshes Tab.....	86
2.4.6 Movie Tab.....	86

## 3 Working with Protein Structures.....89

3.1 Searching the PDB.....	89
3.1.1 Searching the PDB.....	89
3.1.2 Sensitive PDB Similarity Searches.....	91
3.1.3 PDB Search Results Table.....	91
3.1.4 Loading Your PDB File.....	92
3.1.5 Load and Display NMR Structures.....	92
3.1.6 Occupancy Display.....	92
3.1.7 Hyperlinks to PDB Website and UniProt.....	92
3.1.8 Display PDB Header.....	93
3.1.9 Direct link to PubMed.....	93
3.2 Converting PDB Files Into ICM Objects.....	93
3.3 How to Display the Ligand Binding Pocket Surface and Neighboring Residues.....	94
3.4 How to Display Hydrogen Bonds.....	95

## 4 Molecular Graphics.....99

4.1 Molecule Representation.....	99
4.1.1 Structure Representation.....	99
4.1.2 Wire Representation.....	101
4.1.3 Stick and Ball (Xstick) Representation.....	101
4.1.4 Ribbon Representation.....	103
4.1.5 Skin Representation.....	104
4.1.6 CPK Representation.....	104
4.1.7 Surface Representation.....	105
4.1.8 Display and Undisplay Hydrogens.....	105
4.1.9 Display Hydrogen Bond.....	106

# Table of Contents

## 4 Molecular Graphics

4.1.10 Display Formal Charges.....	108
4.2 Meshes – Surface – Grobs.....	108
4.2.1 Surfaces .....	109
4.2.2 Meshes .....	110
4.2.3 Macroshape.....	111
4.2.4 Google 3D Objects (Sketchup).....	111
4.2.5 Display or Undisplay Meshes or Surfaces.....	111
4.2.6 Mesh Options.....	112
4.2.7 Move and Resize Mesh.....	112
4.2.8 Color and Mesh Display.....	113
4.2.9 Mesh Clipping.....	114
4.2.10 Save Mesh.....	115
4.2.11 Occlusion Shading.....	115
4.3 Coloring .....	115
4.3.1 Coloring .....	116
4.3.2 Color Background.....	116
4.3.3 Background Image.....	117
4.4 Lighting .....	118
4.5 Labeling and Annotation.....	118
4.5.1 Labeling .....	119
4.5.2 Labeling Atoms.....	119
4.5.3 Labeling Residues.....	119
4.5.4 Move Residue Label.....	120
4.5.5 Label Variables.....	120
4.5.6 Labeling Sites.....	121
4.5.7 Annotation .....	122
4.5.8 Changing Label Colors.....	123
4.5.9 Customized Label 2D or 3D.....	123
4.5.10 Undisplay Customized Label.....	124
4.5.11 Labeling Distances.....	124
4.5.12 (Un)display Origin.....	125
4.5.13 Displaying Tethers.....	126
4.5.14 Displaying Distance Restraints.....	126
4.5.15 Display Clash.....	126
4.5.16 Display Rainbow, Box, Ruler.....	127
4.5.17 Display Gradient.....	127
4.6 Display Distances and Angles.....	127
4.6.1 Display Distance Between Two Atoms – the quick way.....	127
4.6.2 Display Planar Angle.....	127
4.6.3 Display Dihedral Angle.....	128
4.6.4 Delete Label.....	128
4.7 Graphics Effects.....	128
4.7.1 Fog .....	128
4.7.2 Shadows .....	128
4.7.3 Sketch Accents.....	129
4.7.4 Elegant Ribbon Ligand Sketch.....	129
4.7.5 Perspective .....	129
4.7.6 Animate View.....	129
4.8 Graphics Shortcuts.....	129
4.9 Molecule Move Buttons.....	130
4.9.1 Rotation .....	130
4.9.2 Custom Rotation.....	130
4.9.3 Translation .....	131
4.9.4 Zoom.....	132
4.9.5 Center .....	132
4.9.6 Torsion Angles.....	132
4.9.7 Connect (Move).....	133
4.10 Clipping Tools.....	133
4.10.1 Mesh Clipping.....	134
4.11 Graphic Layers.....	134
4.12 Make High Quality Publication Images.....	135
4.12.1 Write Image.....	135
4.12.2 How to Save an Image to the Clipboard.....	135
4.12.3 Advanced Image Options.....	136

# Table of Contents

<b>4 Molecular Graphics</b>	
4.12.4 Add Image to Album.....	137
<b>5 Molecular Animations, Slides, and Documents.....</b>	<b>139</b>
5.1 Molecular Animations and Transitions.....	139
5.1.1 Make Animation.....	140
5.1.2 Change Speed, Range and Cycle Length of Animation.....	140
5.1.3 Interrupt Animation.....	140
5.1.4 Saving an Animation.....	141
5.2 Making Molecular Slides.....	141
5.3 How to View and Navigate Slides.....	145
5.3.1 View Slide Show.....	145
5.3.2 Slide Navigation.....	146
5.4 How to Edit Slides.....	147
5.4.1 Edit Slide.....	147
5.4.2 Move Slide.....	148
5.5 How to Add Smooth Blending and Transition Effects Between Slides.....	149
5.6 How to Make Molecular Documents – Link HTML Text to Slides.....	149
5.6.1 How to Add Text or Edit a Molecular Document.....	150
5.6.2 How to Make a Hyperlink Between Text and a Slide.....	152
5.6.3 Insert Image.....	153
5.6.4 Insert Script.....	154
5.6.5 Insert a Dialog Box.....	155
5.6.6 Document Navigation.....	156
5.6.7 Protect Shell Objects From Deletion.....	157
<b>6 ActiveICM.....</b>	<b>159</b>
6.1 How to Embed in Microsoft PowerPoint 2003.....	159
6.2 How to Embed in Microsoft PowerPoint 2007.....	160
6.3 Embed in Web Browser.....	161
6.4 How to Use ActiveICM in PowerPoint.....	162
6.5 How to Change ActiveICM Component Properties.....	163
6.6 Advanced use of activeICM: Macros to direct visualisation changes.....	165
6.6.1 PowerPoint Cache Errors.....	167
<b>7 Movie Making.....</b>	<b>169</b>
7.1 Movie Making Options.....	169
7.2 Screen-grabbing Movie.....	170
7.3 View-Defined Movie Making.....	171
7.3.1 Movie Files and Resolution Setup.....	172
7.3.2 Defining a Movie Scene.....	172
7.3.3 Still.....	173
7.3.4 Tween.....	173
7.3.5 Rotate.....	174
7.3.6 Rock.....	175
7.3.7 Edit a Movie.....	176
7.3.8 Preview and Export.....	177
<b>8 Protein Structure Analysis.....</b>	<b>179</b>
8.1 Find Related Chains.....	179
8.2 Calculate RMSD.....	180
8.3 Contact Areas.....	180
8.4 Identify Closed Cavities.....	181
8.5 Surface Area.....	182
8.6 Measure Distances.....	182
8.7 Planar Angle.....	184
8.8 Dihedral Angle.....	184
8.9 Ramachandran Plot Interactive.....	185
8.10 Export Ramachandran Plot.....	185
<b>9 Proteins Superposition.....</b>	<b>189</b>
9.1 Select Proteins for Superposition.....	189
9.2 Superimpose Button.....	190
9.3 Superimpose by 3D.....	191
9.4 Superimpose Multiple Proteins.....	191

# Table of Contents

<b>9 Proteins Superposition</b>	
9.5 Arrange as Grid.....	192
<b>10 Crystallographic Analysis.....</b>	<b>195</b>
10.1 Crystallographic Neighbor.....	195
10.2 Crystallographic Cell.....	196
10.3 Biomolecule Generator.....	197
10.4 Get Electron Density Map.....	198
10.5 Map's Original Cell.....	200
10.6 Contour Electron Density Map.....	200
10.7 Convert Xray Density to Grid.....	201
<b>11 3D Predict.....</b>	<b>203</b>
11.1 Assign Helices and Strands.....	203
11.2 Protein Health.....	203
11.3 Local Flexibility.....	205
11.4 Protein-Protein Interface Prediction.....	205
11.5 Identify Ligand Pockets.....	206
<b>12 Cheminformatics .....</b>	<b>211</b>
12.1 Reading Chemical Structures.....	214
12.1.1 Loading Chemical Structures.....	214
12.1.2 Chemical Smiles.....	214
12.2 Working with Chemical Spreadsheets.....	215
12.2.1 Molecular Table Display.....	215
12.2.2 How to add columns into a chemical spreadsheet.....	218
12.2.3 How to sort a column(s) in a chemical spreadsheet.....	219
12.2.4 How to change the view of a chemical spreadsheet – form, table and grid.....	220
12.2.5 How to copy, cut and paste columns and rows in a chemical spreadsheet.....	220
12.2.6 How to show and hide columns and rows in a chemical spreadsheet.....	221
12.2.7 How to save a chemical spreadsheet in sdf format.....	222
12.2.8 How to export your chemical spreadsheet into Excel.....	222
12.2.9 How to print a chemical spreadsheet.....	223
12.2.10 How to filter columns in a chemical spreadsheet.....	223
12.2.11 How to use find and replace in a chemical spreadsheet.....	224
12.2.12 How to mark and label rows in a chemical spreadsheet.....	225
12.2.13 How to insert hyperlinks to the PDB, PubMed, and Uniprot.....	225
12.2.14 How to copy and paste 2D chemicals.....	226
12.2.15 How to edit data inside a chemical spreadsheet.....	226
12.2.16 How to remove salts, explicit hydrogens and standardize chemical groups.....	227
12.2.17 How to calculate chemical properties in a chemical spreadsheet.....	227
12.2.18 How to identify duplicate chemicals in a chemical spreadsheet.....	228
12.2.19 How to compare two chemical spreadsheets.....	228
12.2.20 How to merge two chemical spreadsheets.....	229
12.2.21 Display and Convert Molecule.....	229
12.2.22 Copy Molecule.....	229
12.2.23 Edit Molecule.....	230
12.2.24 Color Table Column.....	230
12.2.25 Chemical Display.....	230
12.2.26 Chemical View Options.....	231
12.2.27 Chemical Table Side-by-Side View.....	232
12.2.28 Zoom, Translate and Z-rotate a Chemical in a table.....	233
12.2.29 Set Chemical Table 3D Browse Mode.....	233
12.2.30 Chemical Find and Replace.....	234
12.2.31 Split Chemical(s) into Fragments.....	236
12.2.32 Rotate Chemical for Best-Fit.....	237
12.2.33 Color Chemical Structure.....	237
12.3 Molecular Editor.....	238
12.3.1 Drawing a New Chemical Structure.....	239
12.3.2 Right Click Options.....	242
12.3.3 A dictionary of chemical groups.....	243
12.3.4 Adding and rotating a fragment in molecular editor by clicking-holding-and-dragging.....	243
12.3.5 Property Monitor.....	243
12.3.6 Editing structure using keyboard.....	244

# Table of Contents

## 12 Cheminformatics

12.3.7 Save and Append Chemical Structures.....	244
12.3.8 Editing a Chemical Structure.....	246
12.3.9 Molecular Editor Selections.....	249
12.3.10 Copy, Cut and Paste.....	250
12.3.11 How to use SMILES strings to sketch a chemical.....	250
12.3.12 Undo and Redo.....	251
12.3.13 Isis Draw Copy and Paste.....	252
12.4 How to extract a 2D sketch of a ligand in complex with a PDB structure.....	252
12.5 Saving Chemical Structures and Images.....	252
12.5.1 Saving from a chemical table.....	252
12.5.2 Saving Chemicals in the Molecular Editor.....	254
12.5.3 Saving Chemicals in the ICM Workspace.....	254
12.5.4 Saving Chemical Images.....	254
12.6 Export to Excel.....	254
12.7 IUPAC Chemical Nomenclature.....	255
12.8 Chemical Search.....	255
12.8.1 Query Setup.....	256
12.8.2 Filter Search.....	265
12.8.3 Query Processing.....	266
Data Source.....	266
Query Options.....	267
Results.....	267
Search.....	267
12.8.4 Search a Database by Text.....	267
12.9 Pharmacophore Drawing and Searching.....	268
12.9.1 Pharmacophore Draw 2D.....	269
12.9.2 Pharmacophore Draw 3D.....	270
12.9.3 Pharmacophore Search.....	272
12.9.4 How to extract a 3D pharmacophore from a ligand.....	273
12.9.5 How to color a 2D chemical sketch by pharmacophore feature.....	274
12.10 Find and Replace.....	274
12.11 Generating Chemical Fragments.....	276
12.12 Molcart.....	277
12.12.1 Molcart Installation.....	278
12.12.2 Molcart Getting Started.....	279
12.12.3 Molcart Search.....	279
12.12.4 Molcart Administration.....	283

## 13 Chemistry Menu.....287

13.1 Calculate Properties.....	287
13.2 Standardize Table.....	288
13.3 Annotate By Substructure.....	289
13.4 Align/Color by 2D Scaffold.....	289
13.5 Set Formal Charges.....	290
13.6 Convert.....	290
13.6.1 3D to 2D Depiction.....	290
13.6.2 Convert Smiles to 2D.....	291
13.6.3 Convert Structure to Smiles.....	291
13.6.4 Convert to Racemic.....	291
13.7 Predict.....	292
13.8 Generate Tautomers.....	292
13.9 Generate Stereoisomers.....	293
13.10 Cluster Set.....	296
13.10.1 How to perform chemical clustering.....	296
13.10.2 How to select representative centers from a tree.....	297
13.10.3 How to reorder branches and change the distance of trees.....	298
13.10.4 How to edit the tree – labels, spacing and coloring.....	298
13.11 PCA Analysis.....	299
13.12 Compare Two Sets.....	299
13.13 Merge Two Sets.....	299
13.14 Select Duplicates.....	300
13.15 Combinatorial Chemistry.....	301
13.15.1 Create/Modify Markush.....	301
13.15.2 How to create a Markush structure.....	303



# Table of Contents

## 13 Chemistry Menu

13.15.3 Enumerate by Scaffold.....	306
13.15.4 How to enumerate a Markush library.....	308
13.15.5 R-Group Decomposition.....	310
13.15.6 How to decompose a library based on a Markush structure.....	312
13.15.7 Enumerate by Reaction.....	313
13.15.8 How to enumerate a chemical library by reaction.....	316

## 14 Working with Tables.....321

14.1 Standard ICM Tables.....	321
14.1.1 Generate New Table.....	321
14.1.2 Reading a Table.....	322
14.1.3 Saving a table.....	322
14.1.4 Basic Table Navigation.....	323
14.1.5 Table View (Grid Layout).....	323
14.1.6 Table View Save.....	323
14.1.7 Table Search.....	324
14.1.8 Table Color.....	324
14.1.9 Table Font.....	324
14.1.10 Table Alignment.....	324
14.1.11 Mark a Row.....	325
14.1.12 Table right click options.....	325
14.1.13 Rename a Table.....	325
14.1.14 Clone a Table.....	326
14.1.15 Delete a Table.....	326
14.1.16 Page Setup.....	326
14.1.17 Print a Table.....	326
14.1.18 Export to Excel.....	326
14.1.19 Save a Table.....	326
14.1.20 Change Column and Row Width.....	326
14.1.21 Making Table Selections.....	326
14.1.22 Editing a Table.....	329
14.1.23 Inserting Columns.....	329
14.1.24 Column Statistics.....	330
14.1.25 Inserting Rows.....	330
14.1.26 Copy Cut and Paste Row.....	331
14.1.27 Copy Cell.....	331
14.1.28 Copy Selection to an ICM Table.....	331
14.1.29 Deleting Columns and Rows.....	332
14.1.30 Hide and Show Columns.....	332
14.1.31 Change Column Format.....	333
14.1.32 Table Sorting.....	334
14.1.33 Table Filtering and Appending.....	334
14.1.34 Mark and Select Rows.....	336
14.1.35 Mouse and Cursor Actions on a Table.....	337
14.2 Molecular Tables.....	337
14.3 Plotting Table Data.....	338
14.3.1 Column Histogram.....	339
14.3.2 Histogram Options.....	340
14.3.3 Histogram Bins.....	341
14.3.4 Plotting two columns.....	341
14.3.5 Add a title to a plot.....	342
14.3.6 Axis Options.....	342
14.3.7 Change Axis Data.....	343
14.3.8 Logarithmic Plots.....	343
14.3.9 Change Mark Shape or Size.....	343
14.3.10 Change Mark Color.....	343
14.3.11 Grid and Axis Display.....	344
14.3.12 Least Squares Fitting.....	344
14.3.13 Zoom, Translate and Center.....	345
14.3.14 Plot Selection.....	346
14.3.15 Print Plot.....	347
14.3.16 Saving a Plot Image.....	347
14.3.17 Table Inline Plots.....	347
14.4 Principal Component Analysis.....	348

# Table of Contents

<b>14 Working with Tables</b>	
14.5 Learn and Predict.....	349
14.5.1 Learn .....	350
14.5.2 Predict .....	350
14.5.3 A little theory on learning.....	351
14.5.4 Data Clustering.....	351
14.6 Cluster .....	351
14.6.1 Tree Selection.....	353
14.6.2 Save and Print Tree.....	354
14.6.3 Tree View.....	354
<b>15 Working with Local Databases.....</b>	<b>361</b>
15.1 How to make a local database.....	361
15.2 Browse Database.....	362
15.3 Edit Database.....	364
15.4 Query Local Database.....	366
<b>16 Tutorials .....</b>	<b>369</b>
16.1 Graphical Display Tutorial: Molecule Representation, Coloring, Labeling and Annotation.....	369
16.1.1 Change Molecule Representation and Color.....	369
16.1.2 Annotation .....	371
16.1.3 Labels .....	372
16.1.4 2D and 3D Labels.....	374
16.2 Graphical Selections Tutorial.....	376
16.2.1 Making Basic Selections.....	377
16.2.2 Making Sequence Selections in the ICM Workspace.....	381
16.2.3 Making a Spherical Selection.....	381
16.2.4 Filtering a Selection.....	382
16.2.5 Propagating a selection to all atoms in a residue.....	383
16.3 Generating Fully Interactive Slides for PowerPoint and the Web Tutorial.....	383
16.4 Working with the Molecular Editor.....	388
16.4.1 Draw Chemical.....	388
16.4.2 Edit Chemical.....	390
16.5 Chemical Searching.....	390
16.5.1 Chemical Similarity Searching.....	390
16.5.2 Advanced Chemical Similarity Searching.....	392
16.5.3 3D Pharmacophore Searching.....	393
16.5.4 2D Pharmacophore Searching.....	395
16.6 How to Generate Plots and Histograms.....	396
16.6.1 How to make a histogram.....	396
16.6.2 How to make an X-Y scatter plot.....	397
<b>Index.....</b>	<b>399</b>

# ICM–Chemist User Guide v.3.7–2a

by Ruben Abagyan, Andrew Orry, Eugene Raush, and Maxim Totrov  
Copyright © 2010

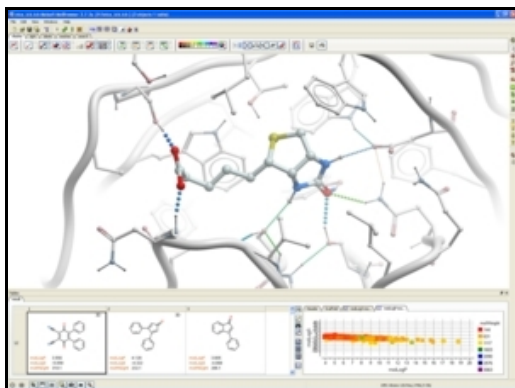

Jan 11 2011  
Feedback.



# 1 How To Guides and Videos

**Note:** Click **Next** (top right hand corner) to navigate through this chapter or use the links below. Headings are listed on the left hand side (web version) or by clicking the **Contents** button on the left-hand-side of the help window in the graphical user interface.

ICM-Browser How To Guide

ICM-Browser-Pro How To Guide

ActiveICM How To Guide - Create 3D Molecular Documents for the Web and PowerPoint

ICM-Chemist How To Guide

ICM-Chemist-Pro How To Guide

## 1.1 ICM-Browser How To Guide

For instructions on how to use ICM-Browser to make fully-interactive 3D slides and publish them in PowerPoint and the web please see the [ActiveICM User Guide](#). ActiveICM is a free plugin for Windows PowerPoint and web browsers. Other related tutorials include:

- Graphical Display: Molecule Representation, Coloring, Labeling and Annotation
- Graphical Selections Tutorial
- Generating Fully Interactive Slides for PowerPoint and the Web Tutorial

### 1.1.1 Download and Install ICM-Browser

<b>Getting Started:</b> Download and Install ICM-Browser and ActiveICM.		
Download ICM-Browser Distribution.	Download	video
Install ICM-Browser Instructions.	Windows Linux Mac	
Download ActiveICM Distribution.	Download	video
Install ActiveICM.	Windows Linux Mac	

### 1.1.2 How to use the Graphical Display

```
}; winRef.document.write(str); }
```

<b>How to use the Graphical Display</b>		
How to search the PDB.	HTML GUI Manual	video
How to Move a Structure in the Graphical Display.	HTML GUI Manual	video

How to use the Graphics window controls.	HTML GUI Manual	
How to use the ICM Workspace Panel	HTML GUI Manual	video
How to Display a Molecule.	HTML GUI Manual	video
How to Change Protein Representation.	HTML GUI Manual	video
How to Change Ribbon Representation.	HTML GUI Manual	video
How to color wire or xstick carbon atoms.	HTML GUI Manual	video
How to Display the Residues Surrounding the Ligand Binding Pocket.	HTML GUI Manual	video
How to remove chain breaks (dotted lines).	HTML GUI Manual	video
How to Color.	HTML GUI Manual	video
How to Change the Color of Molecule Representations.	HTML GUI Manual	video
How to Change the Background Color.	HTML GUI Manual	video
How to Display a Binding Pocket Surface	HTML GUI Manual	video
How to (Un)Display Hydrogens.	HTML GUI Manual	video
How to Save an ICM Object.	HTML GUI Manual	video
How to Save an ICM Project File.	HTML GUI Manual	video
How to Drag and Drop.	HTML GUI Manual	
How to: Right Click Options.	HTML GUI Manual	
How to Move Windows.	HTML GUI Manual	video
How to Arrange Windows	HTML GUI Manual	video

### 1.1.3 How to make Graphical Selections

<b>How to Make Selections.</b>	HTML GUI Manual	
How to Select an Object	HTML GUI Manual	video
How to Select a Molecule	HTML GUI Manual	video
How to Select Residues	HTML GUI Manual	video
How to Select Atoms	HTML GUI Manual	video
How to Make a Spherical Selection.	HTML GUI Manual	video
How to Invert a Selection.	HTML GUI Manual	video
How to Remove a Selection.	HTML GUI Manual	video
How to Change the Selection Level and Mode.	HTML GUI Manual	video
How to Check What is Selected.	HTML GUI Manual	

### 1.1.4 How to Convert Proteins, Display Hydrogens and Ligand Binding Pocket.

<b>Convert Protein, Display Hydrogens and Ligand Binding Pocket.</b>		
How to Convert a PDB Structure into an ICM Object.	HTML GUI Manual	video
How to Display Ligand Binding Pocket.	HTML GUI Manual	video
How to Display Hydrogen Bonds.	HTML GUI Manual	video

### 1.1.5 How to change Graphics Effects

<b>How to change Graphics Effects</b>		
How to display the FOG effect.	HTML GUI Manual	video
How to display side-by-side stereo.	HTML GUI Manual	
How to toggle full screen mode.	HTML GUI Manual	video
How to adjust perspective.	HTML GUI Manual	
How to change the lighting.	HTML GUI Manual	video
How to display sketch accents.	HTML GUI Manual	video
How to display elegant ribbon and ligand sketch.	HTML GUI Manual	video

## 1.1.6 How to add Labels and Annotations

<b>How to add Labels and Annotations</b>		
How to Label Residues.	HTML GUI Manual	video
How to Label Atoms.	HTML GUI Manual	video
How to Label Variables.	HTML GUI Manual	video
How to Display and Undisplay Sites.	HTML GUI Manual	
How to Make and Display Annotations.	HTML GUI Manual	
How to Make and Display 2D and 3D Labels.	HTML GUI Manual	video

## 1.1.7 How to Make High Quality Publication Images

<b>How to Make High Quality Publication Images</b>		
How to Toggle High Quality Display	HTML GUI Manual	video
How to Toggle Antialiasing.	HTML GUI Manual	video
How to Copy Image to ClipBoard	HTML GUI Manual	video
How to Write an Image.	HTML GUI Manual	video
How to Use the Advanced Write Image Options.	HTML GUI Manual	video
How to Add an Image to the ICM Photo Album.	HTML GUI Manual	video

## 1.1.8 How to Superimpose Protein Structures.

<b>How to Superimpose Protein Structures.</b>		
How to Superimpose Two or More Protein Structures.	HTML GUI Manual	video

## 1.1.9 How to Measure Distances and Angles.

<b>How to Measure Distances and Angles.</b>		
How to Measure Distances Between Two Atoms.	HTML GUI Manual	video
How to Measure Distances From One Atom to Many.	HTML GUI Manual	video
How to Show Corresponding Distances in Two Objects.	HTML GUI Manual	video
How to Display the Ruler Bar.	HTML GUI Manual	video



## 1.2 ICM–Browser–Pro How To Guide

**NOTE:** ICM–Browser–Pro contains all the features in ICM–Browser. [Click here](#) for the ICM–Browser How To Guide.

### 1.2.1 Download and Install ICM–Browser–Pro

<b>Getting Started:</b> Download and Install ICM–Browser–Pro	
Download ICM–Browser–Pro Distribution.	Download
Install ICM–Browser–Pro.	Windows Linux Mac

### 1.2.2 Graphics

<b>Graphics and Movie Making</b>	
How to generate the shadow effect.	HTML GUI Manual
How to make a screenshot movie	HTML GUI Manual
How to make a view–defined movie	HTML GUI Manual
How to move a molecule independently of the other display objects (Connect).	HTML GUI Manual

### 1.2.3 Protein Structure Analysis

<b>Protein Structure Analysis</b>	
How to calculate contact areas between molecules.	HTML GUI Manual
How to identify closed cavities.	HTML GUI Manual
How to calculate surface area.	HTML GUI Manual
How to generate interactive Ramachandran plots.	HTML GUI Manual

### 1.2.4 Surfaces

<b>Surfaces</b>	
How to generate electrostatic and binding property surfaces.	HTML GUI Manual
How to connect and rotate/translate surface (mesh).	HTML GUI Manual
How to crop a mesh/surface.	HTML GUI Manual
How to save a mesh/surface.	HTML GUI Manual

## 1.2.5 Superimpose Proteins

Superimpose Proteins	
How to superimpose proteins based on 3D by visible atoms, C-alpha, backbone or heavy atoms.	HTML GUI Manual
How to superimpose multiple proteins based on aligned residues..	HTML GUI Manual
How to superimpose by specific interatomic pairs.	HTML GUI Manual

## 1.2.6 Crystallographic Tools

Crystallographic Tools	
How to contour electron density.	HTML GUI Manual
How to display crystallographic cell.	HTML GUI Manual
How to display crystallographic symmetry.	HTML GUI Manual
How to convert x-ray density to a grid.	HTML GUI Manual

## 1.2.7 Sequence Analysis

Sequence Analysis	
How to annotate an alignment – box and shade.	HTML GUI Manual
How to annotate an alignment with text.	HTML GUI Manual
How to display secondary structure in an alignment.	HTML GUI Manual
How to extract sequences from pdb files.	HTML GUI Manual
How to assign secondary structure.	HTML GUI Manual
How to link sequence, alignments, and structures.	HTML GUI Manual
How to save as image, print, and delete sequences and alignments.	HTML GUI Manual

## 1.2.8 Plotting Tools

Plotting Tools	
Make fully interactive colorful X-Y plots and histograms with up to 4 dimensions.	HTML GUI Manual
Save plot and histogram as image.	HTML GUI Manual

## 1.3 ActiveICM How To Guide – Create 3D Molecular Documents for the Web and PowerPoint

This guide is focused on how to make fully interactive 3D documents for Windows PowerPoint and the Web. For more information on the other features in ICM–Browser please see the ICM–Browser User Guide.

### Creating 3D Documents Is Straightforward

Creating fully interactive 3D documents for PowerPoint, the web, and standalone browser is straightforward.

1. Download ICM–Browser and the ActiveICM plugin. They are completely free! [video]
2. Open the ICM–Browser and make a series of animated fully–interactive slides showing different colored and rendered views of your molecules. [video]
3. Add hyperlinked HTML text to annotate and link to your slides. [video]
4. Save your file in ICM–Browser and then insert into PowerPoint or the web using the ActiveICM plugin. You can also share your documents in the standalone ICM–Browser. [video – powerpoint] [video –web browser]

```
}; winRef.document.write(str); }
```

#### 1.3.1 Getting Started

<b>Getting Started:</b> Download and Install ICM–Browser and ActiveICM.		
Download ICM–Browser Distribution.	Download	video
Install ICM–Browser Instructions.	Windows Linux Mac	
Download ActiveICM Distribution.	Download	video
Install ActiveICM.	Windows Linux Mac	

#### 1.3.2 How to Create a Series of Fully–Interactive 3D Slides.

<b>Creating Slides</b> How to Create a Series of Fully–Interactive 3D Slides.	video
How to Make Fully Interactive 3D Slides	HTML GUI Manual
How to Animate Slides	HTML GUI Manual
How to View and Navigate Slides in the ICM–Browser.	HTML GUI Manual
How to Edit Slides.	HTML GUI Manual
How to Add Smooth Blending and Transition Effects Between Slides.	HTML GUI Manual

#### 1.3.3 How to Create Molecular Documents

<b>How to Create Molecular Documents:</b> Linking Slides to HTML Text.	video
--	-------

How to Create an HTML Document.	HTML GUI Manual
How to Edit an HTML Document.	HTML GUI Manual
How to Make a Hyperlink Between HTML Text and a Slide.	HTML GUI Manual

### 1.3.4 How to Display Molecular Documents in PowerPoint

<b>How to Display Molecular Documents in PowerPoint</b>	video
How to Embed in Microsoft PowerPoint 2003	HTML GUI Manual
How to Embed in Microsoft PowerPoint 2007	HTML GUI Manual
How to Use ActiveICM in PowerPoint	HTML GUI Manual
How to Change ActiveICM Component Properties in PowerPoint	HTML GUI Manual
Advanced use of ActiveICM: Macros to direct visualisation changes.	HTML GUI Manual

### 1.3.5 How to Display Molecular Documents on the Web

<b>How to Display Molecular Documents in Web Browsers</b>	video
How to Display Molecular Documents in Web Browsers	HTML GUI Manual

## 1.4 ICM–Chemist How To Guide

### 1.4.1 How to Import, Sketch, and Edit Chemicals

<b>How to Import, Sketch, and Edit Chemicals</b>		
How to access the ICM Molecular Editor.	HTML GUI Manual	video
How to sketch chemicals in the ICM Molecular Editor.	HTML GUI Manual	video
How to save a 2D sketch into a chemical spreadsheet.	HTML GUI Manual	video
How to save a 2D sketch in mol format.	HTML GUI Manual	video
How to use SMILES strings to sketch a chemical.	HTML GUI Manual	video
How to load a mol, sdf or mol2 file.	HTML GUI Manual	video
How to extract a 2D sketch of a ligand in complex with a PDB structure.	HTML GUI Manual	video

## 1.4.2 How to Work with Chemical Spreadsheets

Working with Chemical Spreadsheets		
How to add columns into a chemical spreadsheet.	HTML GUI Manual	video
How to sort a column(s) in a chemical spreadsheet.	HTML GUI Manual	video
How to change the view of a chemical spreadsheet – form, table and grid.	HTML GUI Manual	video
How to copy, cut and paste columns and rows in a chemical spreadsheet.	HTML GUI Manual	video
How to show and hide columns and rows in a chemical spreadsheet.	HTML GUI Manual	video
How to save a chemical spreadsheet in sdf format.	HTML GUI Manual	video
How to export your chemical spreadsheet into Excel.	HTML GUI Manual	video
How to print a chemical spreadsheet.	HTML GUI Manual	video
How to filter columns in a chemical spreadsheet.	HTML GUI Manual	video
How to use find and replace in a chemical spreadsheet.	HTML GUI Manual	video
How to mark and label rows in a chemical spreadsheet.	HTML GUI Manual	video
How to insert hyperlinks to the PDB, PubMed, and Uniprot.	HTML GUI Manual	video
How to copy and paste 2D chemicals.	HTML GUI Manual	video
How to edit data inside a chemical spreadsheet.	HTML GUI Manual	video
How to remove salts, explicit hydrogens and standardize chemical groups.	HTML GUI Manual	video
How to calculate chemical properties in a chemical spreadsheet.	HTML GUI Manual	video
How to identify duplicate chemicals in a chemical spreadsheet.	HTML GUI Manual	video
How to compare two chemical spreadsheets.	HTML GUI Manual	video

How to merge two chemical spreadsheets.	HTML GUI Manual	video
---	-----------------	-------

### 1.4.3 How to Undertake a Chemical Search

<b>How to Perform Chemical Searching</b>		
How to setup a chemical search.	HTML GUI Manual	video
How to draw a chemical search query.	HTML GUI Manual	video
How to add conditions to your chemical search.	HTML GUI Manual	video
How to search chemical spreadsheets, local databases and MolCart.	HTML GUI Manual	video
How to send a chemical search query.	HTML GUI Manual	video

### 1.4.4 How to Work with Pharmacophores

<b>How to Work with Pharmacophores</b>		
How to draw 2D pharmacophore.	HTML GUI Manual	video
How to search a 2D pharmacophore.	HTML GUI Manual	video
How to draw 3D pharmacophore.	HTML GUI Manual	video
How to extract a 3D pharmacophore from a ligand.	HTML GUI Manual	video
How to edit a 3D pharmacophore.	HTML GUI Manual	video
How to send a 3D pharmacophore search query.	HTML GUI Manual	video
How to color a 2D chemical sketch by pharmacophore feature.	HTML GUI Manual	video

### 1.4.5 How to Perform Chemical Clustering

<b>How to Perform Chemical Clustering</b>		
How to perform chemical clustering.	HTML GUI Manual	video
How to select representative centers from a tree.	HTML GUI Manual	video
How to reorder branches and change the distance of trees.	HTML GUI Manual	video
How to edit the tree – labels, spacing and coloring.	HTML GUI Manual	video

## 1.4.6 How to Generate Stereoisomers and Tautomers

How to Generate Stereoisomers and Tautomers		
How to generate stereoisomers.	HTML GUI Manual	video
How to generate tautomers.	HTML GUI Manual	video

## 1.4.7 How to Generate Combinatorial Libraries

How to Generate Combinatorial Libraries		
How to enumerate a Markush library.	HTML GUI Manual	video
How to decompose a library based on a Markush structure.	HTML GUI Manual	video
How to create a Markush structure.	HTML GUI Manual	video
How to enumerate a chemical library by reaction.	HTML GUI Manual	video

## 1.4.8 How to Generate Plots and Histograms

How to Generate Plots and Histograms		
How to make a histogram.	HTML GUI Manual	video
How to make an X–Y scatter plot.	HTML GUI Manual	video





## 2 Getting Started

**Note:** Click **Next** (top right hand corner) to navigate through this chapter. Headings are listed on the left hand side (web version) or by clicking the **Contents** button on the left-hand-side of the help window in the graphical user interface.

The **Graphical User Interface** (GUI) has many components. When you first use the GUI the default window layout is displayed as shown below.

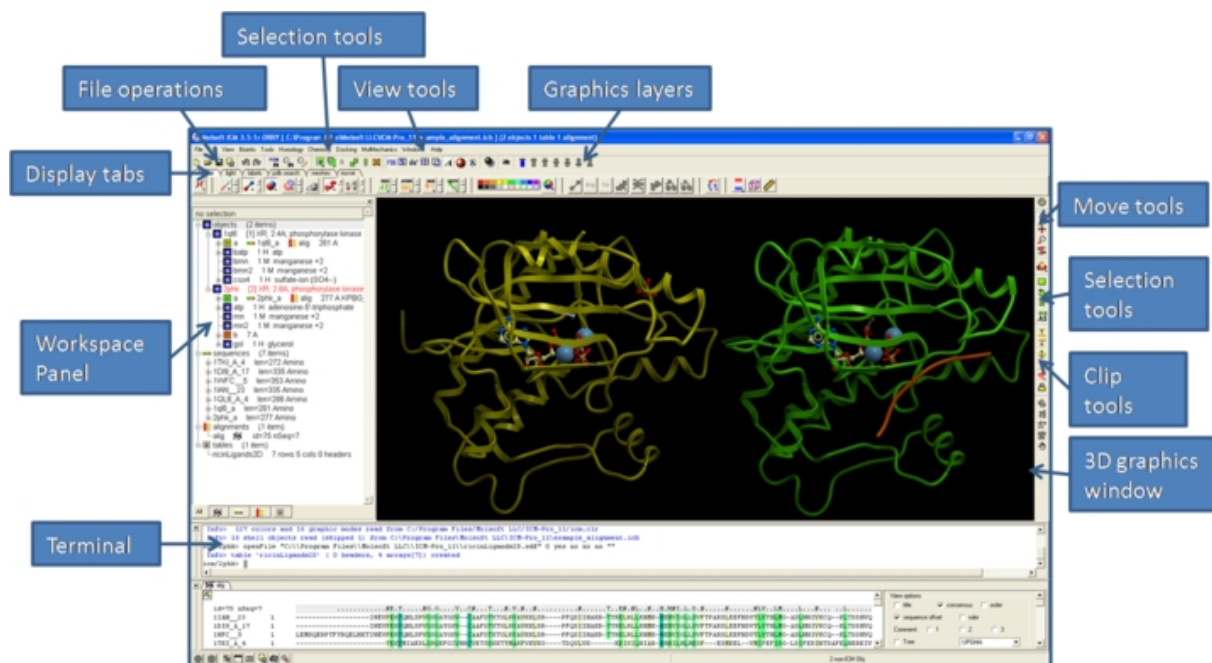

### 2.1 How to Use the Graphical Display

#### 2.1.1 How to load a PDB Structure

There are three main ways to read in a PDB file.

1. Using the command line.
2. Using File/Open button
3. Using the PDB Search tab

Other PDB search options are described in more detail in the PDB Search section of this manual.

Opens a dialog to locate a PDB file on a local filesystem

Enter PDB code or a PDB Search String

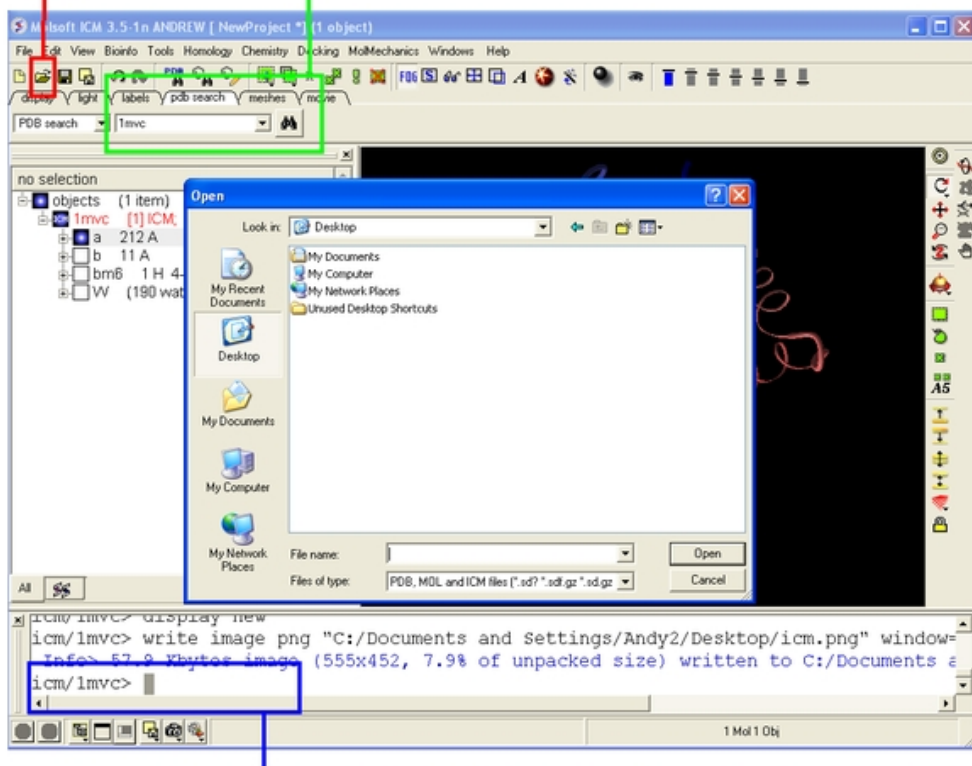

Simply type the command - read pdb "PDB\_Code" and ICM will fetch the structure from the PDB website

## 2.1.2 How to Move a Structure in the Graphical Display

Available buttons and options for moving molecules around the graphical display window. This is described in more detail in the section entitled Move Buttons.

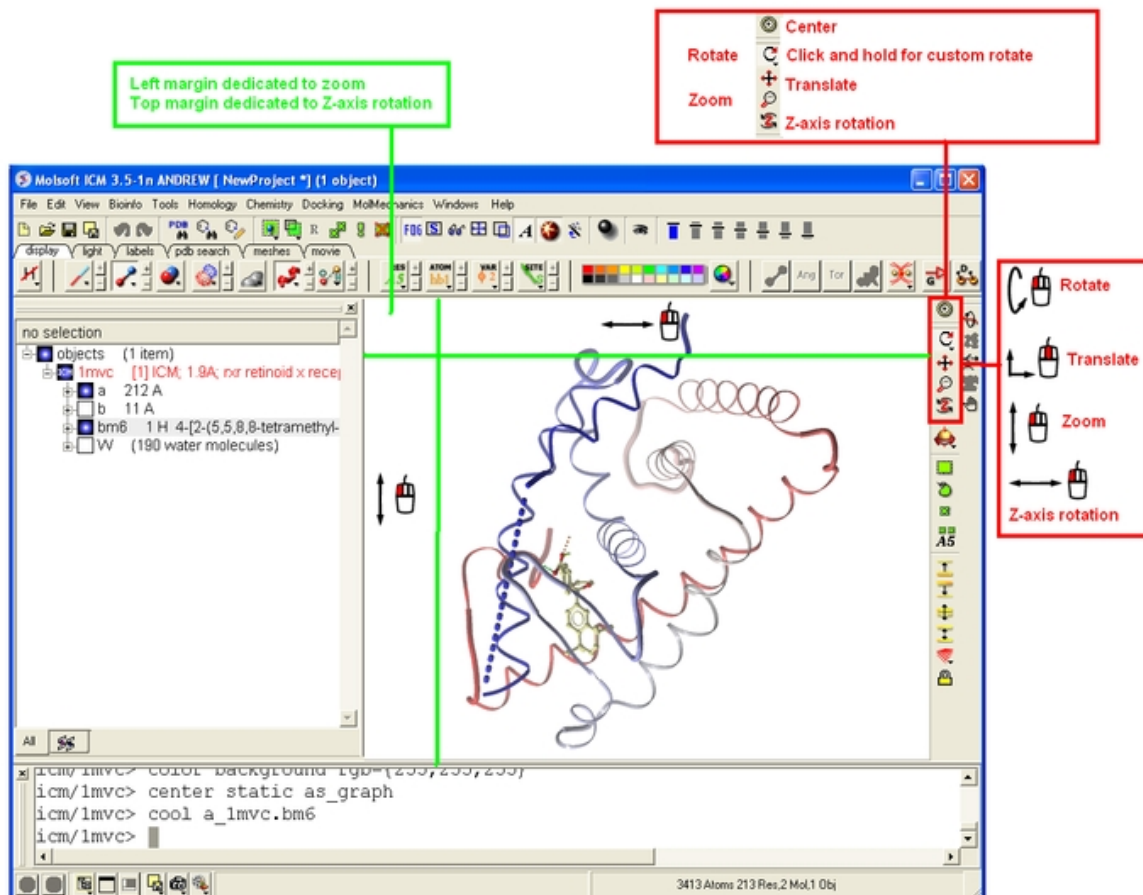

## 2.1.3 How to use the Graphics window controls

In the graphics window you can use various tools described elsewhere but it is helpful to know the following things:

- **Picking a tool:** the left mouse button will function according to the selected tool
- **Popup menus:** right click on an atom gives a pop-up menu
- **Selecting in the rotation mode:** the right mouse button will select atoms
- **Translating in the rotation mode:** the middle mouse button will translate the scene
- **Zooming and moving clipping planes in the rotation mode:** the left, top and right margins of the graphics window are reserved for other actions, zoom, z-rotation, and clipping planes, respectively. That means that even if you are picking atoms, by pressing control you can still rotate your molecule with the left-mouse-button.
- **Rotating in any non-rotation mode:** if you press **Control** in any mouse mode, e.g. zoom, pick etc., it will temporarily switch to **rotation**
- **Escaping from the connect and continuous movement modes:** pressing **Escape** helps to get out of certain modes, such as Full Screen, Continuous rotation or rocking, the Connect mode.
- **Global rotation in the Connected mode:** pressing **Shift** will temporarily switch to the global rotation/translation mode.

## 2.1.4 How to Make Selections

Making selections in ICM is an important skill to master (e.g. you may want to select a binding pocket for docking or a region of a molecule for coloring). The four levels of selection are:

1. Atoms
2. Residues
3. Molecules
4. Objects (multiple molecules comprising a PDB entry)

There are several ways of making selection in ICM. The simplest is to interact directly with the graphics window – **right-click, hold and drag** around the area of the screen you want to select. Alternatively, in the workspace window, expand the tree of molecules and chains until the relevant protein sequences are displayed. Then left click and drag to mark residues to form a selection.

See the chapter entitled Making Selections for more information.

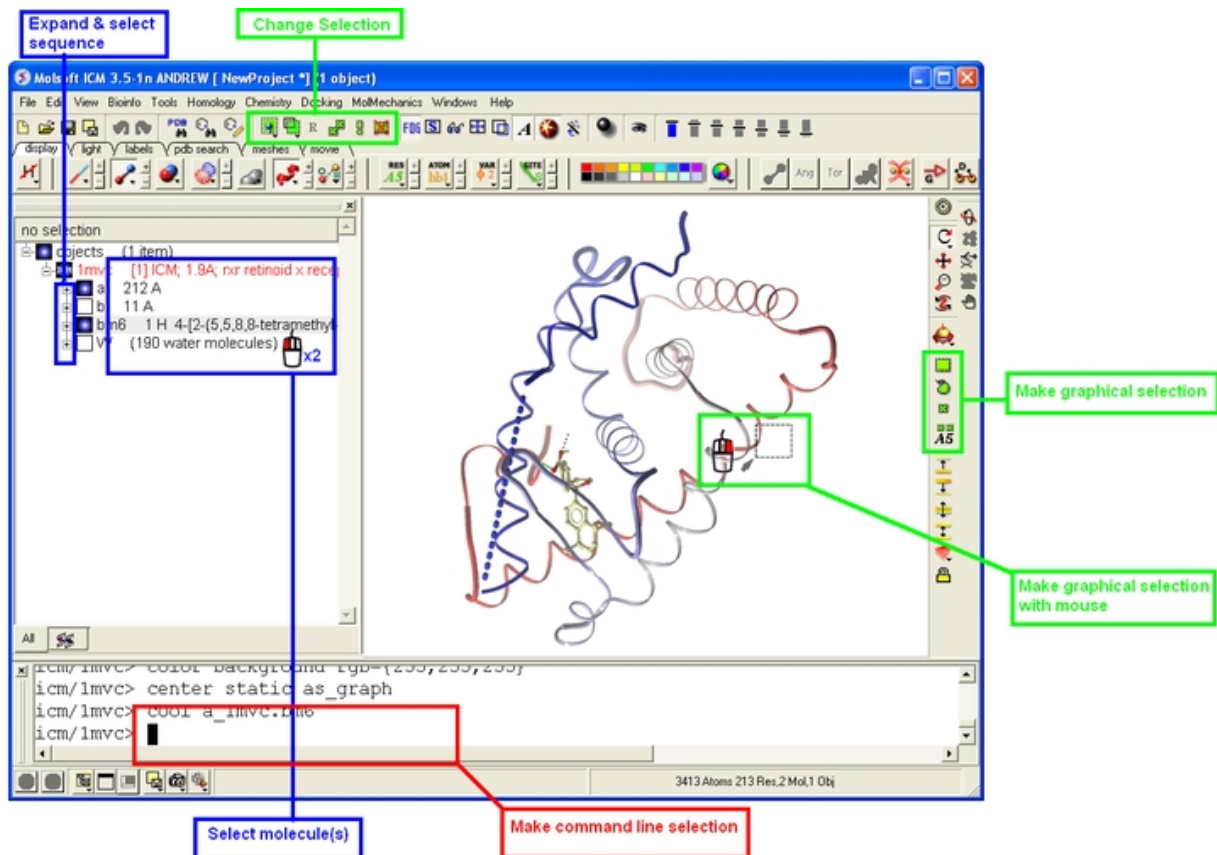

## 2.1.5 How to Change the Selection Level and Mode

It is possible to change the level of selection before or during the building of a selection. The selection level drop-down button can be used to do this (see image below).

For example, a C-alpha of a residue is selected but one would like to select all atoms in the residue. You can change the level to **Residues**. This selection can then be changed into all atoms of the residue by then selecting the **Atoms** level again. Or you can use the **Propagate Selection to all Atoms** button (see image below).

It is also important to observe the selection mode that is being used. There are four modes:

- **New:** new selection replaces everything selected before
- **Add:** new selection is added to previous selection(s), if any
- **Remove:** previously selection (part or whole of it), if included in the new selection will be unselected.
- **Toggle:** within the new selection, everything that has been selected is unselected and everything that hasn't been selected, will be selected

See the chapter entitled Making Selections for more information.

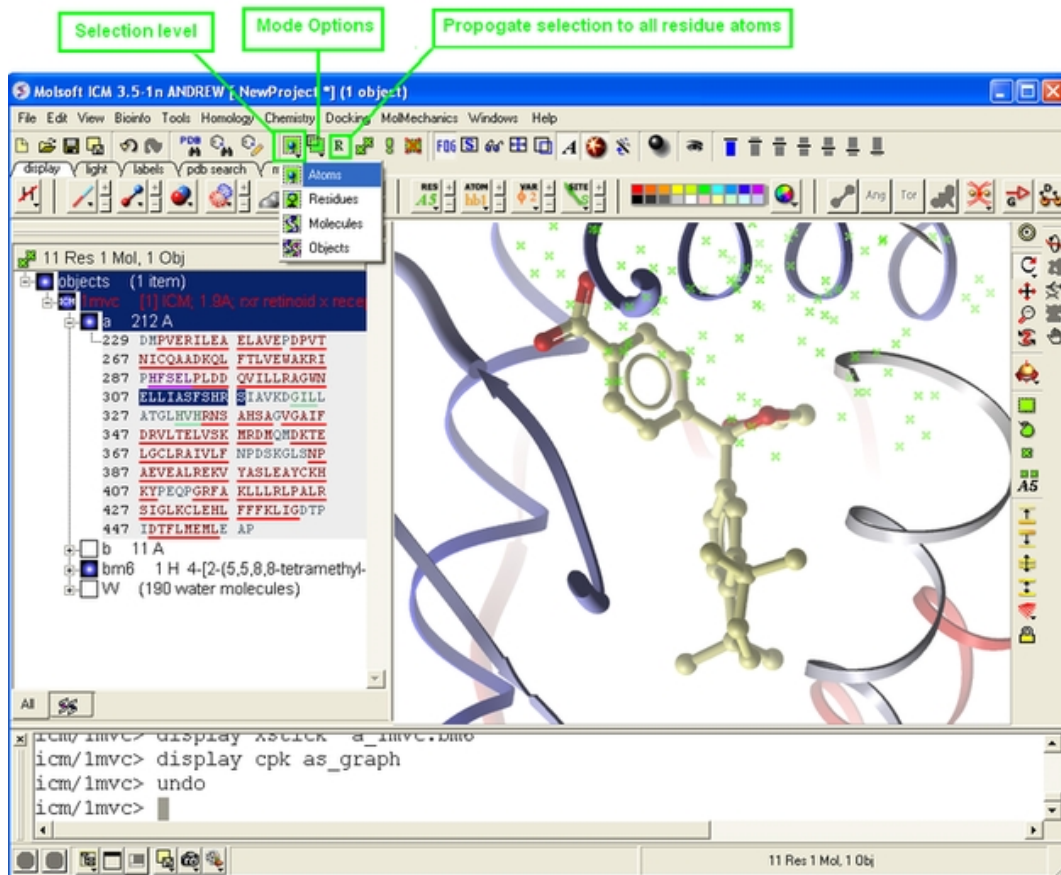

## 2.1.6 How to Check What is Selected

Once you have made your selection – how can you be sure you have made it and what exactly have you selected. See the chapter entitled Making Selections for more information.

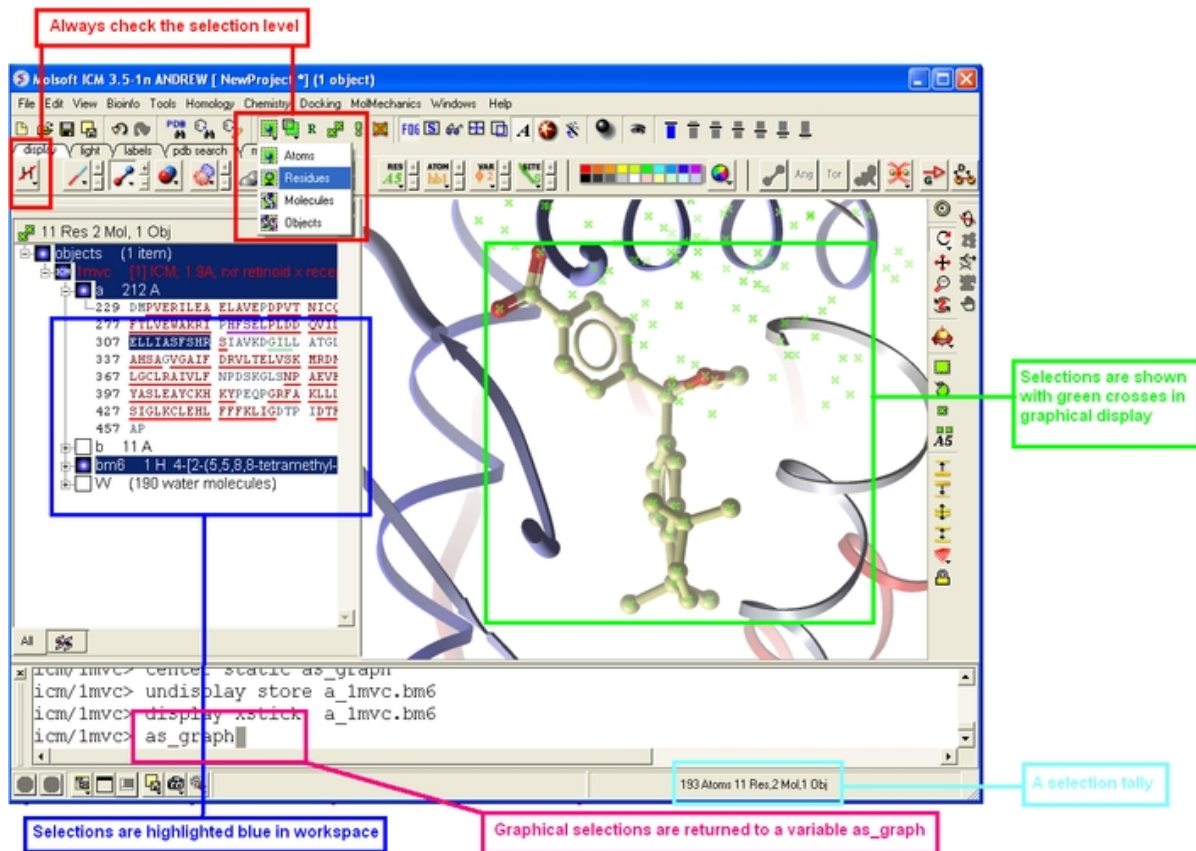

## 2.1.7 How to use the ICM Workspace Panel

The workspace panel (located on the left hand side panel of the gui) is an important place within the graphical user interface because it displays which sequences, structures, objects, tables and alignments are currently loaded into ICM. Also, from this panel you can make graphical selections and drag and drop objects and sequences to other locations within the GUI. More details about how to use the ICM Workspace Panel for displaying structures can be found here .

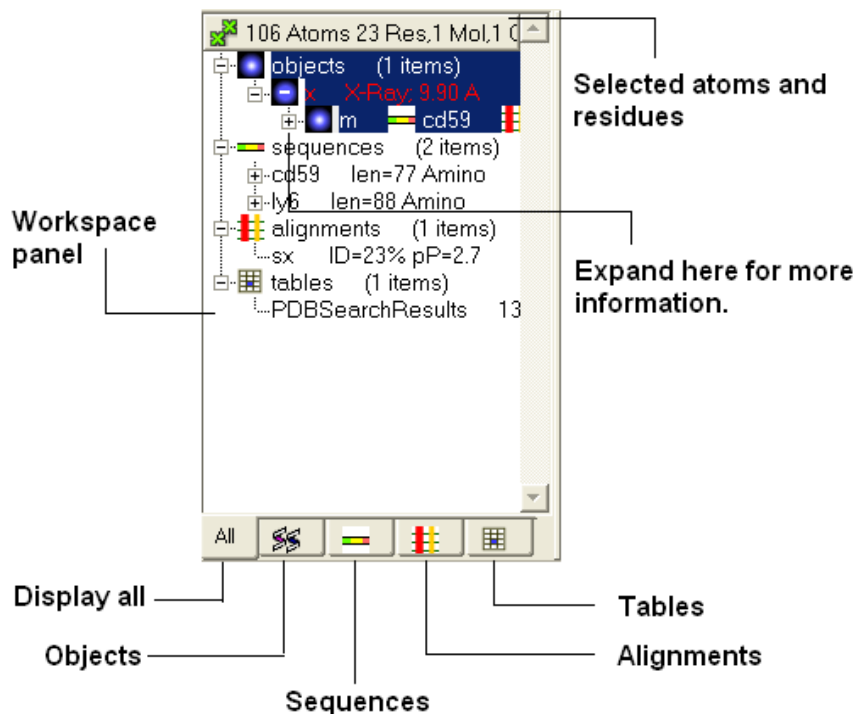

## 2.1.8 How to Display a Molecule

Once a structure has been loaded into ICM the individual components of that structure (i.e. amino acids, metal ions, binding sites etc) are listed in the ICM workspace.

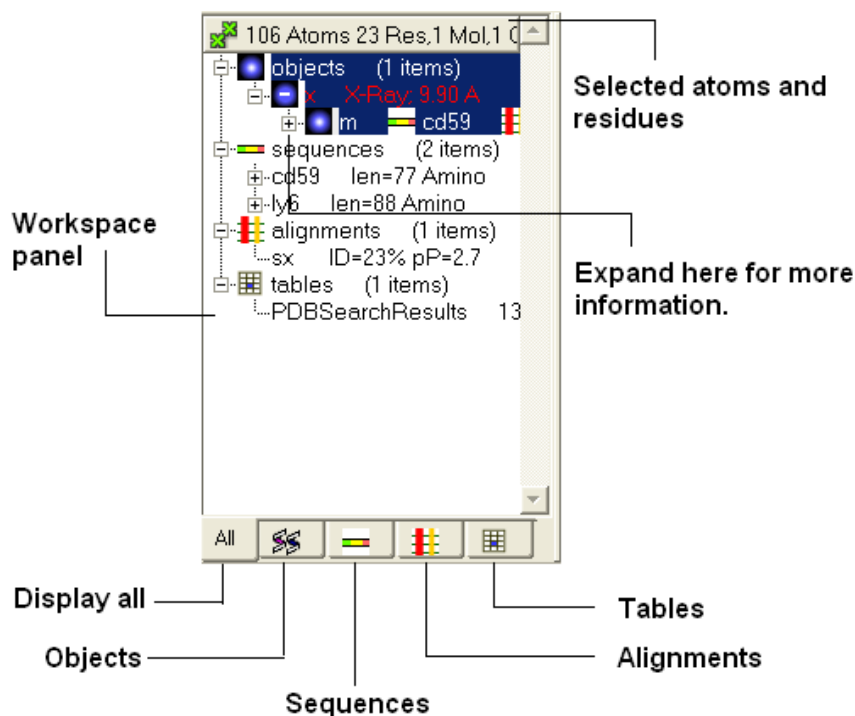

To display every component of the object except for binding sites and water atoms:

- Click on the white box next to the word object at the top of the ICM workspace. This box will be colored blue once the structure is displayed

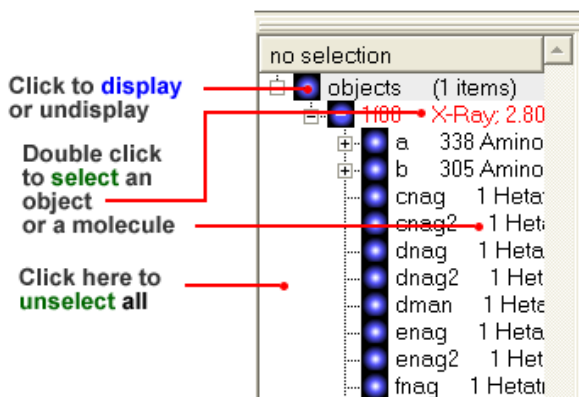

To display the whole structure in wire, ribbon, cpk, skin, surface and xstick representations:

- Right click on the blue box next to the word object. A menu will be displayed.

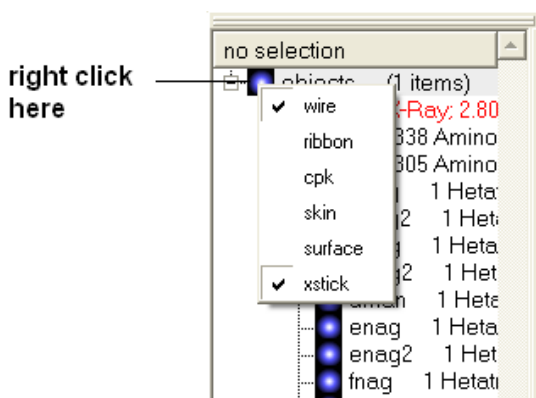

- Select which representation you desire for your structure by clicking on the appropriate word. A check mark indicates the representation currently displayed. To un-display a particular representation click on the word again.

In order to clear your graphical display:

- Select **View/Undisplay All**

If you only wish to display part of the structure then click in the boxes further down the tree in the ICM workspace.

To display the selected regions of the structure in wire, ribbon, cpk, skin, surface and xstick representations:

- Right click on the appropriate box in the **ICM** workspace. A menu will be displayed.
- Select which representation you desire for your structure by clicking on the appropriate word. A check mark indicates the representation currently displayed. To un-display a particular representation click on the word again.



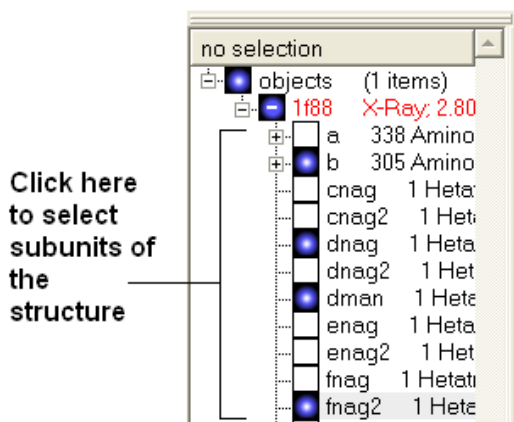

## 2.1.9 How to Change Protein Representation

To change the representation of the protein, make a make-selection{selection} and then use the tools in the display tab.

There are 6 main types of representation:

- **Wire:** Wires connecting covalently bound atoms of a molecule. This representation has no defined thickness as such will not make shadows. Useful for showing the chemical structure of a small molecule.
- **Xstick:** Covalent bonds are represented as cylinders whilst atoms are represented as small spheres.
- **CPK:** Atoms are represented as spheres with their respective van der Waals radius and coloured according to a standard defined by Corey, Pauling and Kuntz.
- **Surface:** Solvent accessible surface. This is the center of water sphere as a water probe rolls over the molecule.
- **Skin:** A Connolly molecular surface over the selection. This is a smooth envelope touching the van der Waals surface of atoms as a water probe rolls over the molecule.
- **Ribbons:** Cartoon representation of protein and DNA secondary structure. Protein residues marked as alpha-helices ('H') are shown as a flat, helical ribbon, those marked as beta-sheets ('E') are shown as a flat ribbon with an arrow-head, and the rest are shown as a cylindrical "worm". If secondary elements are not defined everything will be shown as a cylindrical worm. ICM can automatically assign secondary structure: Tools/3D predict /Assign Helices and Strands

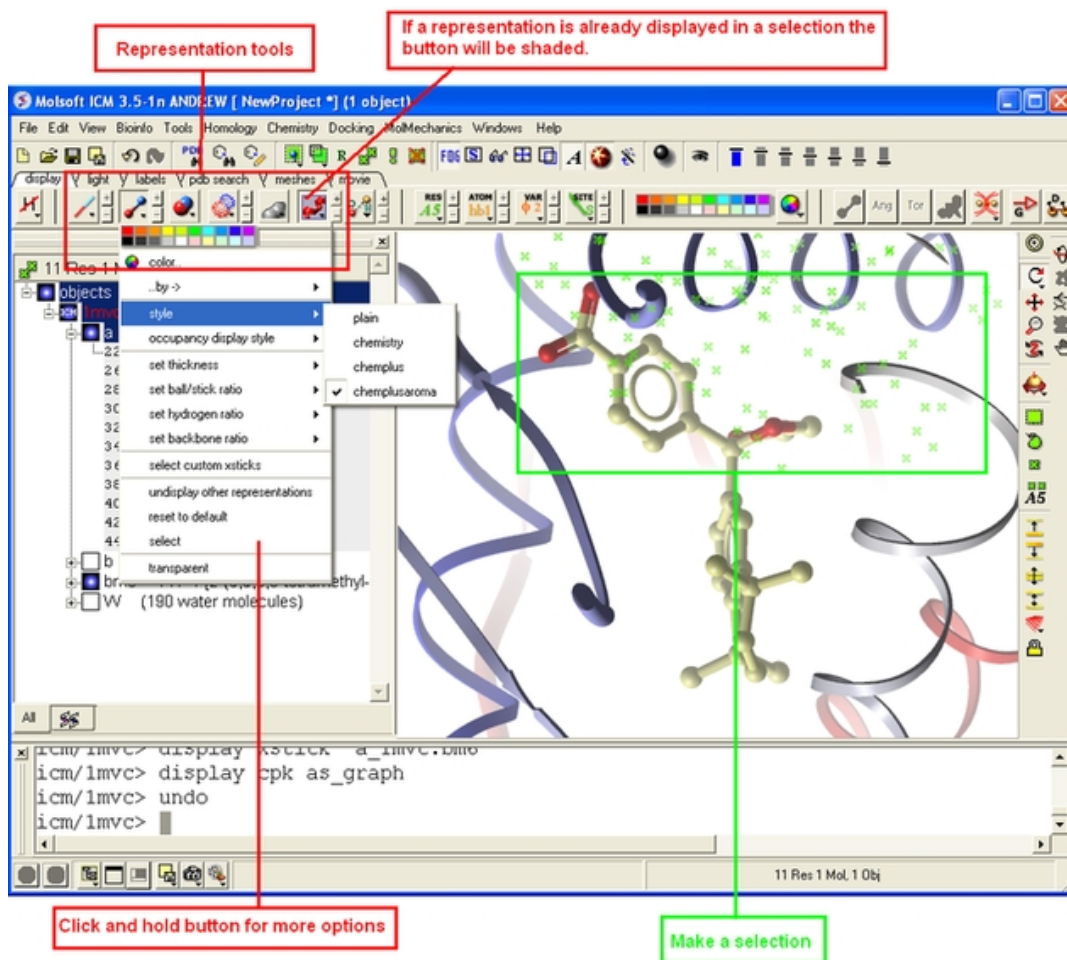

## 2.1.10 How to remove chain breaks (dotted lines)

Chain breaks in a protein structure are represented by dotted lines. To remove them use

```
GRAPHICS.chainBreakStyle =1
```

e.g.

```
read pdb "1xbb"
cool a_
GRAPHICS.chainBreakStyle = 1 # this removes the dotted lines between chain breaks
```

In version 3.6–1a and above you can use the options in the display tab. Click and hold on the ribbon button and then select **Display Chain Breaks/ None**.

## 2.1.11 How to Color

To change the color of the representation you need to use the buttons in the display tab.

Changing the colour of a representation works in much the same way as displaying the representation itself. The selection rationale is the same followed by clicking on a colour in the palette. It is also possible to colour different representations of the same selection independently (e.g. when displaying a loop (selection series of residues), represented as ribbon and xsticks; colour the ribbons of that selection in cyan and the xsticks in red).

To change the color of any representation - click and hold. The color will apply to the selection and the chosen representation only. If nothing is selected then everything displayed in chosen representation will be colored

Left click will change selected foreground color and right click will change the background.

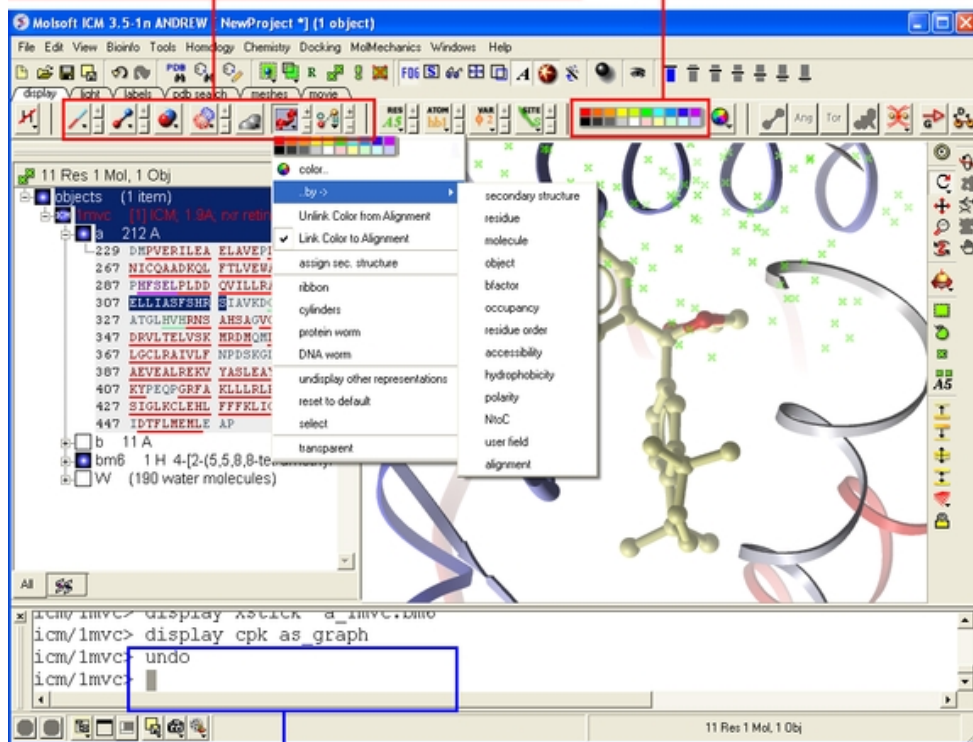

ICM command language can make coloring easier

## 2.1.12 How to Display a Binding Pocket Surface

To display the surface of a small molecule ligand or peptide binding pocket:

- Load the PDB of interest.
- Convert PDB to ICM object. If you do not convert you will not get the properties of the pocket displayed on the surface.
- Right click on the small molecule or peptide in the ICM Workspace and select **Ligand Pocket**.

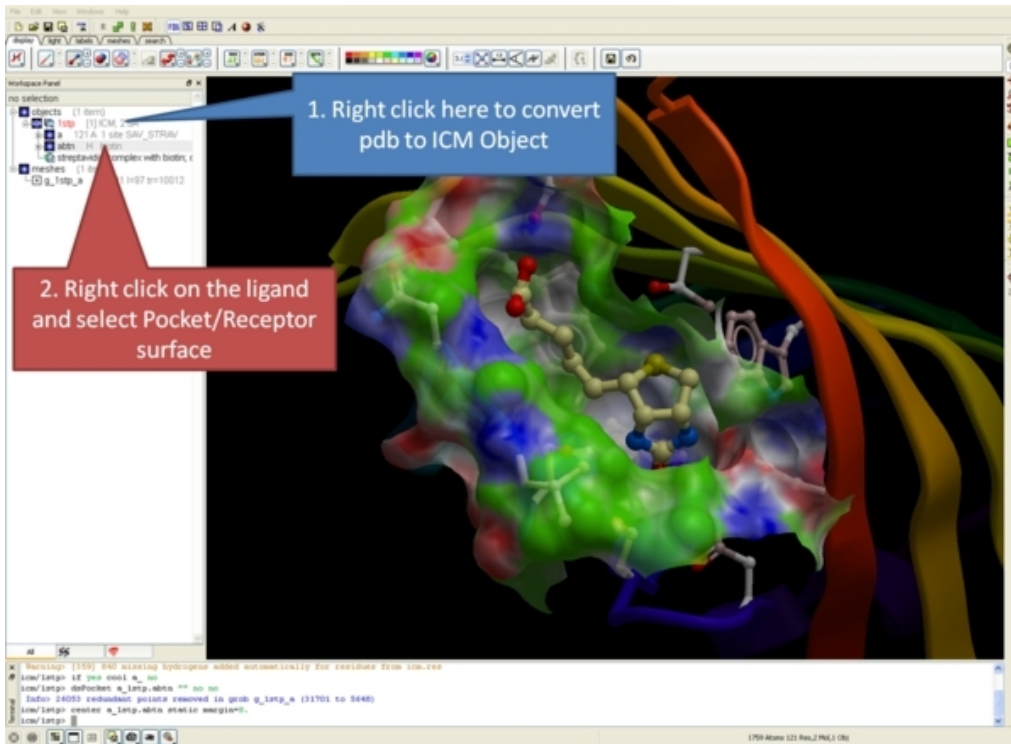

## 2.1.13 How to Save an ICM Object

Any ICM object such as a structure, sequence, or alignment, can be saved for use at a later time.

To save an object:

- Right click on the object name in the ICM workspace or ICM alignment editor and a menu will be displayed.
- Click on the **Save As...** option.
- Enter the unique name you wish to call your object in the box labeled **File name:**
- Choose which folder or directory you wish to save your object by clicking scrolling down in the box labeled **Save in:**
- Choose which file type you would like to save your object as by scrolling down in the box labeled **Save as type** . ICM structure objects should have the file ending yourfilename.ob and alignments yourfilename.ali
- Once the appropriate information has been entered click on the **Save** button in the bottom right hand section of the window.
- The object is now saved.

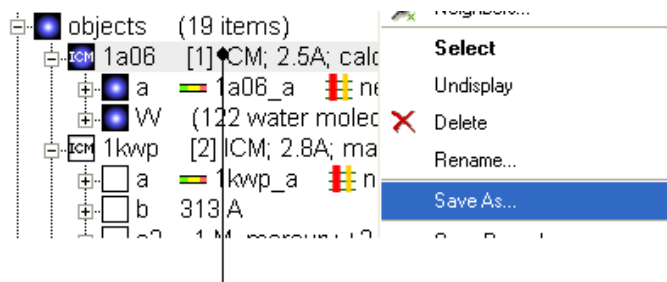

To save an ICM object or PDB file right click and select **SaveAs..**

## 2.1.14 How to Save an ICM Project File

All objects contained within an ICM session can be saved in a single file with the extension .icb. The file can then be read into ICM and the exact layout of the file will be preserved. To save a project file go to the **File** menu and select **Save Project**.

## 2.1.15 How to Drag and Drop

**NOTE:** "Drag and Drop" is a useful way of moving objects and sequences around the graphical user interface.

Sequences and objects can be moved around the graphical user interface by dragging and dropping them. All loaded sequences and objects are always displayed in the workspace panel. Select the desired object or sequence from the workspace panel by clicking and holding, move the selection to the desired location and release.

This is a useful application in the graphical user interface. For example, you may have an alignment displayed and you wish to add another sequence to the alignment. This can simply be accomplished by dragging a loaded sequence from the workspace panel into the alignment display panel. Or, you can quickly view an object by dragging and dropping it from the workspace panel into the 3D graphics window.

## 2.1.16 How to: Right Click Options

**NOTE:** If you right click on any object you will see a new menu of options related to that object.

The right click mouse option can be used throughout the graphical user interface. It is a very useful means of opening up a whole new world of menus and options. Most of these options are described in this book. However, when using the graphical user interface it is always a good idea to try right clicking the mouse on an object and seeing which extra options that are available for you to use.

## 2.1.17 How to Move Windows

It is possible to move some windows around the graphical user interface to make viewing easier.

Click here to drag the window to another location within the graphical user interface.

Click here to close window

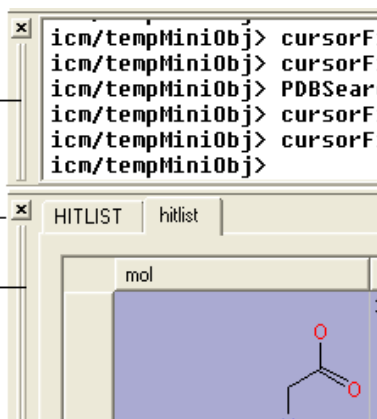

It is also possible to separate menus from the GUI.

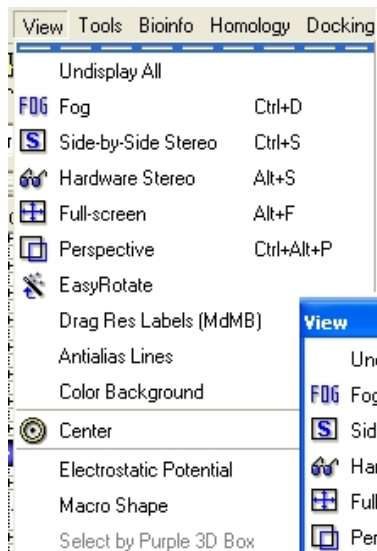

Click here to tile menu

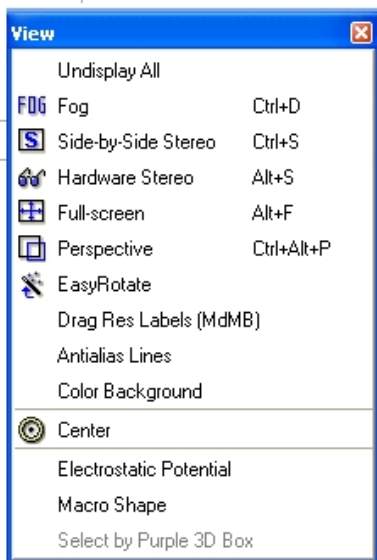

Menu becomes a separate window for easy viewing and access.

**NOTE:** To return to the default display option select the 'Default layout' option in the windows menu.

OR

Click the default layout icon.

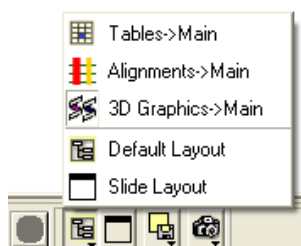

Some options can be accessed at the bottom of the GUI.

OR

Double click on the window header.

## 2.1.18 How to Arrange Windows

Sometimes when using ICM you may have many items displayed such as structures, alignments and tables. As a default the graphical display is the largest and centered in the middle of the ICM graphical user interface. However if you wish to work on an alignment or table you can place the alignment or table as the main display by clicking on the buttons shown below. The larger display generally makes it easier to manipulate the alignment or table. There are ofcourse other ways to alter the layout such as tier the windows but this option is just a simple click and can sometimes come in useful.

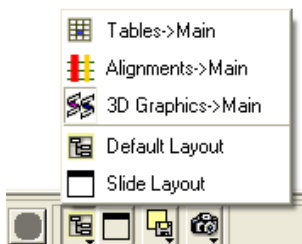

## 2.1.19 How to Make a Picture

There are several ways of taking a picture of the contents of the 3D graphical display window see the [write image](#) section. However the easiest way is to simply click on the button in the view tools panel (see image below).

**Simply click here for a QUICK high quality image**

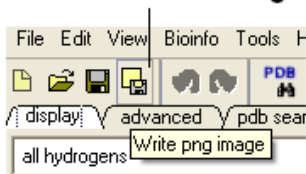

Or select /File/Quick Image

The picture will be automatically saved as a PNG file in the directory from which you loaded ICM. The default picture name is icm[n].png, where n is the number of pictures taken in one ICM session. To save in other picture formats and to change the file name see the [write image](#) section.

## 2.2 Making Selections

**Note:** Click **Next** (top right hand corner) to navigate through this chapter. Headings are listed on the left hand side (web version) or by clicking the **Contents** button on the left-hand-side of the help window in the graphical user interface.

There will be many occasions when you will have to make selections. For example, if you want to display a particular region or molecule contained within your protein structure or if you want to select residues around a binding pocket. If you have a molecule displayed in the graphics window, then selections will be displayed as green crosses. The selection you have made is also displayed at the top of the ICM Workspace. It is always a good idea to keep an eye on what is selected and what isn't.

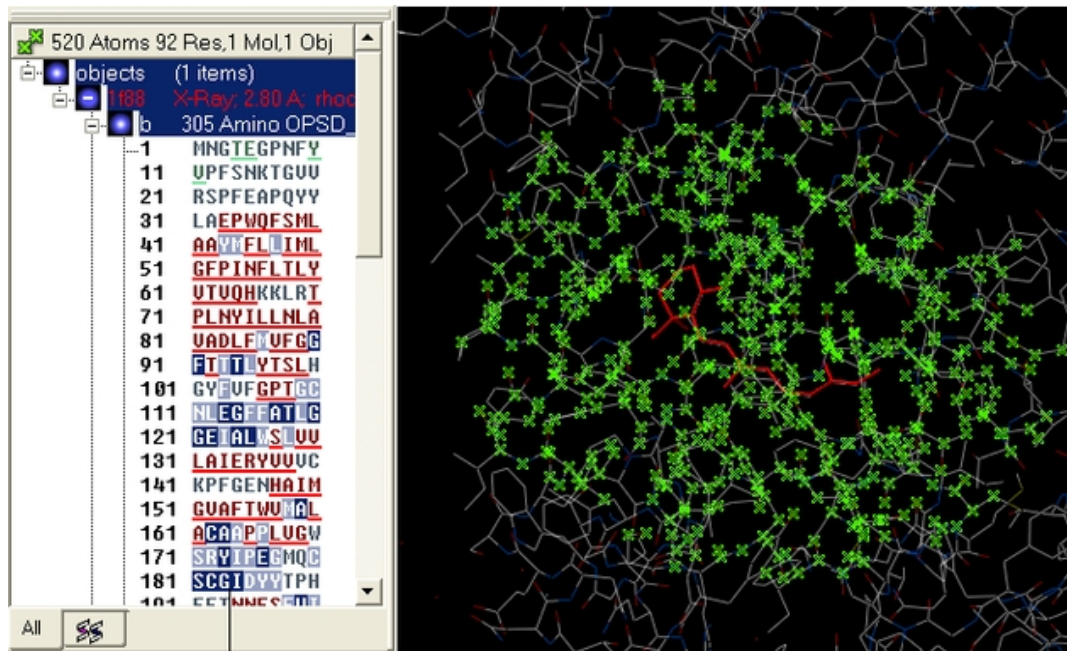

Workspace and graphical selections

There are four basic levels of selection

1. Object (eg a PDB structure or ICM object)
2. Molecule
3. Residue
4. Atom

You can make selections in:

- The Graphics Display
- The ICM Workspace (Selections are highlighted in blue)
- Tables
- Sequences
- Plots
- Alignments

## 2.2.1 Graphical Selections

In this section you will learn how to select parts and certain regions of molecules from the 3D graphical display. Graphical and molecule selections are required for many operations within ICM. For example, if you wanted to display graphically part of a molecule or if you wanted to perform a minimization of residues within a sphere of an important atom.



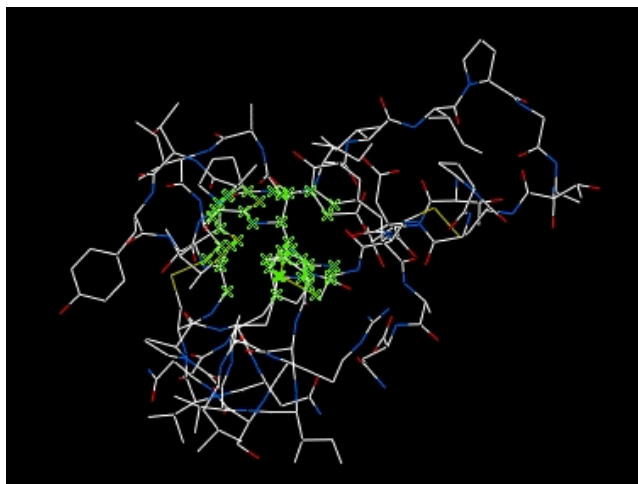

Selection shown in green.

## 2.2.2 Selection Tools

The following buttons can be used to make a selection once a structure is displayed.

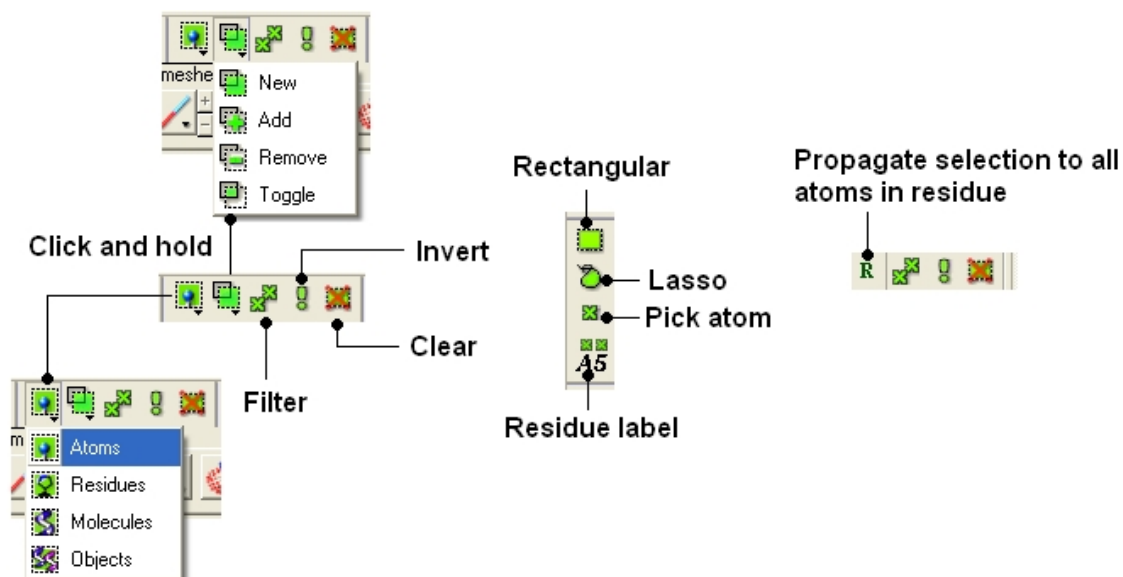

**NOTE:** All selection tool buttons are colored green. Graphical selections are represented as green crosses.

## 2.2.3 Basic Selections

To make a basic selection (ie nothing too complicated!) the following buttons can be used.

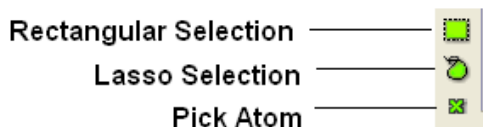

*To select parts of your structure:*

- Click on the **Rectangular selection icon** and click and drag around the part of the structure you wish to select.

OR

- Click on the **Lasso selection icon** and click and drag your mouse around the area of the structure you wish to select, forming a lasso around it.

*To pick individual atoms:*

- Click on the 'pick atom' button

*You can also change the level of a selection using the button shown below. Click and hold the button to choose the level of selection. For example, if you have selected atoms you can convert the selection to all atoms at the residue level by choosing the Residues option.*

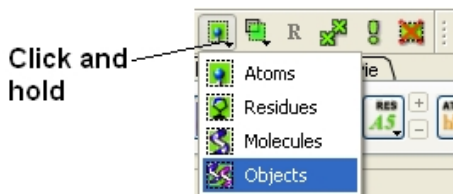

- Click on the **Select objects**, **Select molecules**, **Select residues**, or **Select atoms** icon, depending on which part of the structure you wish to be highlighted.

**NOTE:** The selection you have made is always recorded at the top of the ICM workplace. If you are familiar with using the ICM terminal (See language manual) the atoms, residues, molecules or objects selected interactively in the graphics window are automatically stored in the `as_graph` variable.

## 2.2.4 Clear Selection

*To unselect everything you have previously selected:*

- Simply click on the **Clear Selection** button on the selection toolbar.

OR

- Right click and drag away from the displayed structure.

## 2.2.5 Altering a Selection

Once you have made a selection you may wish to add or remove parts of the selection. The buttons shown below allow you to accomplish this.

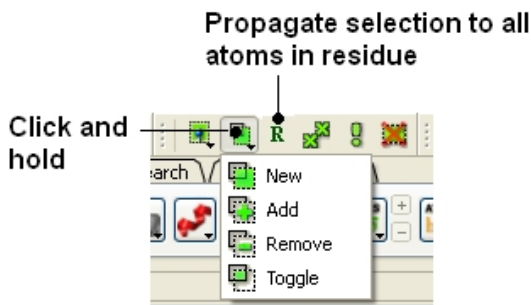

*To add or remove from your current selection:*

- Click on the **Selection mode: add** or **Selection mode: remove** icon on the toolbar.
- Click and drag around the part of your structure you wish to add or remove.

*You may also wish to invert your selection in a specific part of the structure.*

The parts that are currently selected will become unselected, and the unselected parts will become selected.

In order to invert a selection:

- Click on the **Invert** icon on the toolbar.

If you wish to select and unselect certain regions of a selection the toggle selection button is very useful.

- Click on the Toggle selection button.
- Right click around the selections you wish to select or unselect.

**NOTE:** The selection you have made is recorded at the top of the ICM workplace. Any selection is stored in the variable as\_graph.

## 2.2.6 Filter Selection

You may want to be very specific about a selection you want to make. For example you may only want to select protein backbone atoms.

The button shown below enables you to filter your selection:



Or

Right click on a selection and a menu as shown below will be displayed.

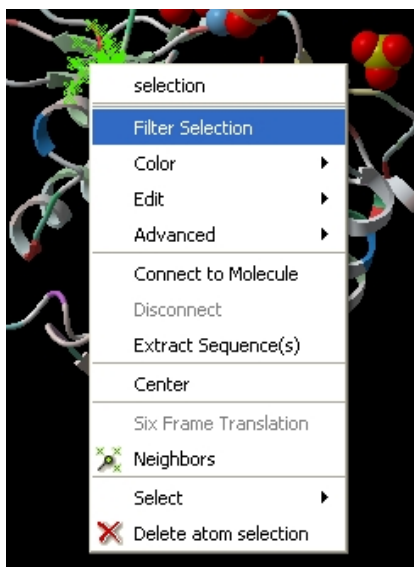

- Select the Filter Selection option.

*If you wish to filter and select by residue or atom type:*



- Click on the Filter graphical selection icon on the toolbar and a data entry box as shown below will be displayed.



*To select just the protein or just the hetatoms as well:*

- Click on the Mol tab.
- Check the appropriate boxes depending on your desired selection.

*To filter by residue type or secondary structure:*

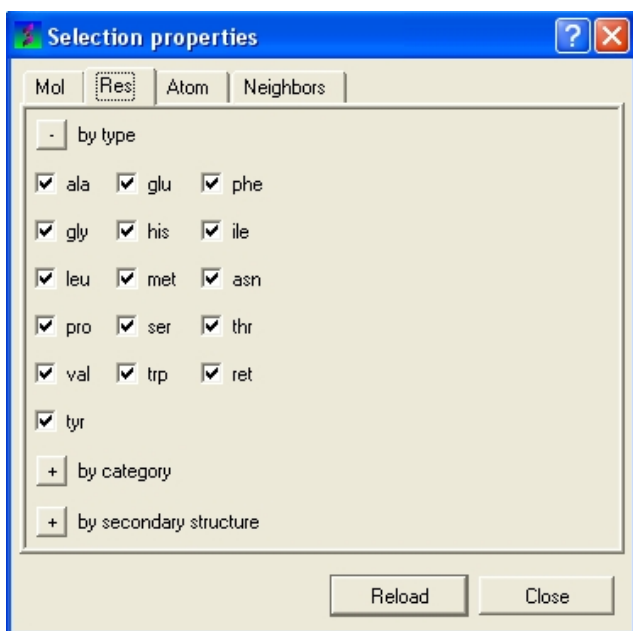

- Click on the Res tab.
- Check the appropriate boxes.

**NOTE:** You may need to click on the button marked with a '+' symbol to expand the options.

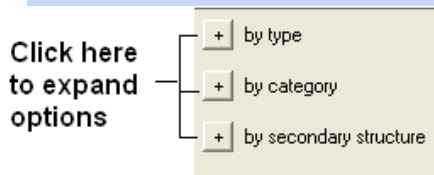

*To filter by atom type.*

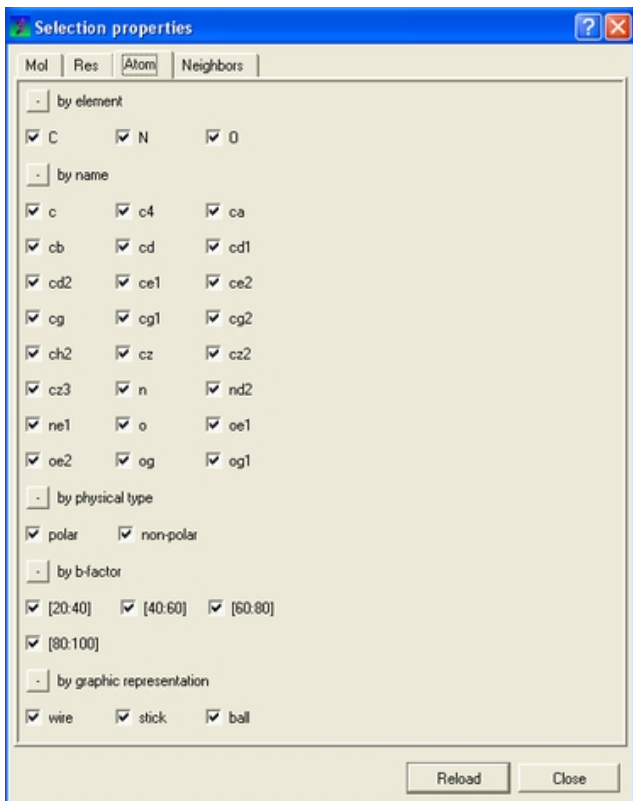

- Click on the Atom tab.
- Check the appropriate boxes.

**NOTE:** You may need to click on the button marked with a '+' symbol to expand the options.

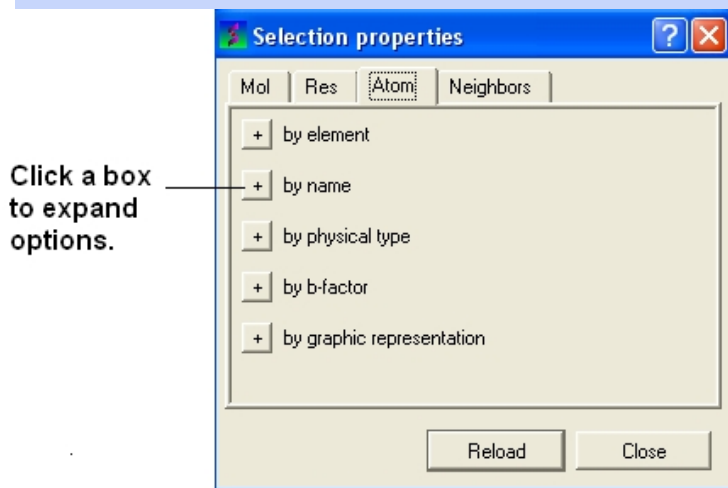

**To select neighbors to a particular selection.**

- See the `select neighbours` section for detailed instructions.

**NOTE:** The selection you have made is always recorded at the top of the ICM workplace. If you are familiar with using the ICM terminal (See language manual) the atoms, residues, molecules or objects selected interactively in the graphics window are automatically s

## 2.2.7 Workspace Selections

In the default GUI layout the workspace panel is located to the left of the 3D graphics display. It is a great tool for keeping track of all your sequences, pdb structures, objects, tables and alignments. As you will see in this section it also provides a way of making selections.

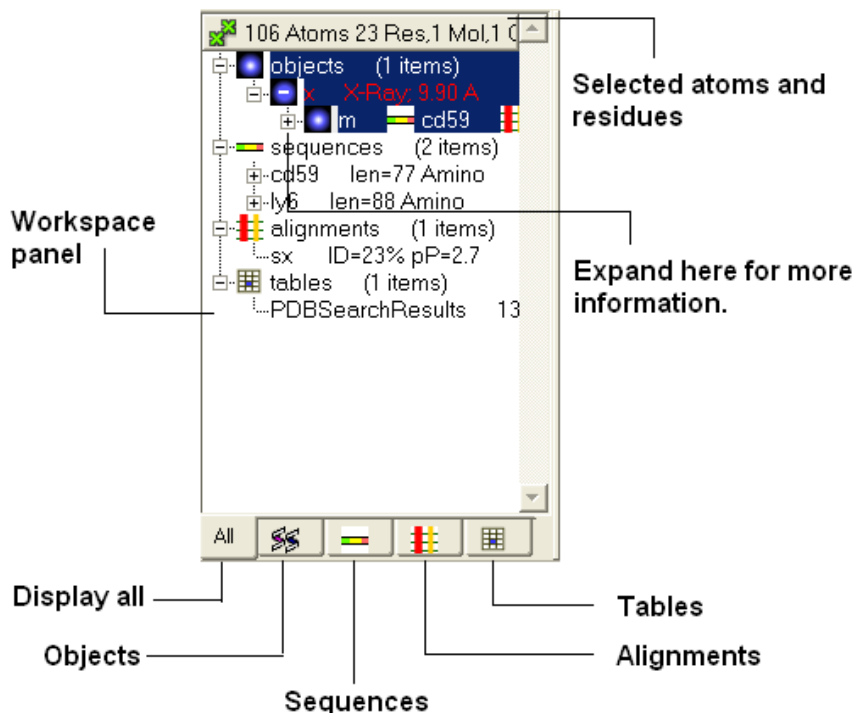

## 2.2.8 Workspace Navigation

Once you have mastered how to navigate the ICM workspace making a selection will become easier. Each object is divided into 3 levels:

1. Object Level – Shown in red if it is the current object. Holds details about the structure – name, X-ray, NMR, resolution etc. Importantly it will state whether the structure is an ICM object or a structure straight from the PDB. To learn how to convert a PDB into an ICM object go to the section on converting a PDB.
2. Molecular Level – Shows the individual subunits, ligands and hetatoms of a molecule.
3. Residue Level – Shows the sequence.

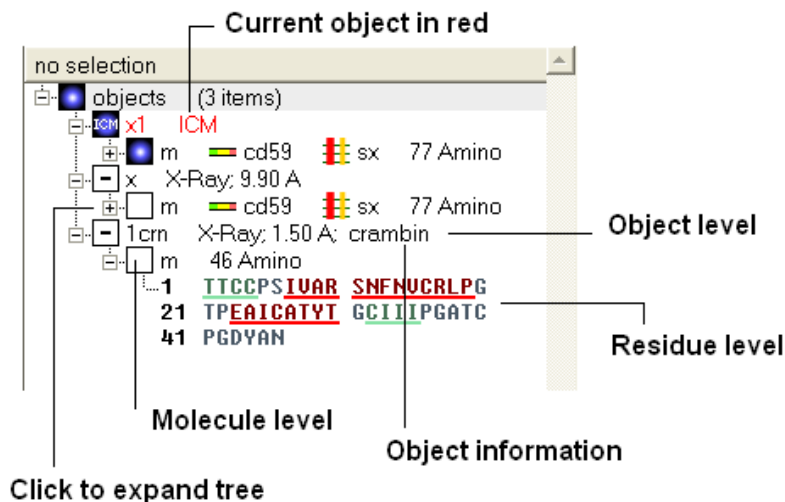

**NOTE:** You can expand each level of the ICM workspace by clicking the "+" button as shown above.

## 2.2.9 Selecting the Whole Object

*To select the whole object:*

- Double click on the object level.

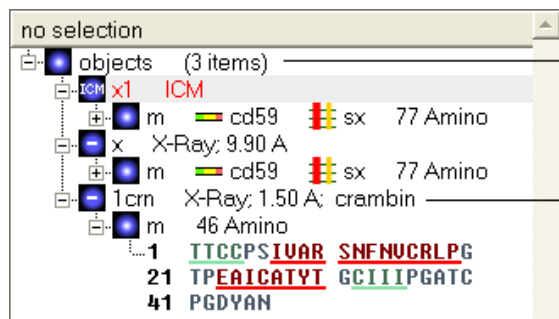

Double click here to select ALL currently loaded objects.

Double click here at the object level to select the whole object

## 2.2.10 Selecting Amino Acids

There are three options to select individual amino acid residues:

### OPTION 1:

- Click and drag over the residues you wish to select in the ICM workspace. Selected residues will be highlighted in dark blue in the workspace and with green crosses in the graphical display.

Selection information is recorded here

184 Atoms 35 Res.1 Mol.1 Obj

objects (1 items)

- 1crn X-Ray: 2.88 A: rhodopsin
  - a 338 Amino OPSD\_BOVIN
    - 1 MNGTEGPNFY UPFSNKTGVU
    - 21 RSPFEAPQVY LAEPVQFSML
    - 41 RAYMELLIML GFPINFLTLY
    - 61 UTUQHKKLRV PLNYILLNLA
    - 81 VADLFHVFEGG FTTTLYTSLH
    - 101 VYFVFGPTGC NLEGFATLIG
    - 121 GEIALWLSLV LAIERYVUUC
    - 141 KPMSNFRFGE NHAINGUAFT
    - 161 WUHALACAAP PLUGWSRYIP
    - 181 EGTQSCGID YYTPHEETNN
    - 201 ESFUIYMFUV HFIPLIUIF
    - 221 FCYGLQVFTV KEAASATTQ
    - 241 KAEKEUTRMV IIMVIAFLIC
    - 261 WLPYAGUAFY IFTHQGSDFG
    - 281 PIENTIPAFF ARTSAUVNPU
    - 301 IYIMNKKQFR NCHUTTLCCG
    - 321 KNPSTTUSKT ETSQVAPA

Click here to expand tree to show amino acid residues.

Click and drag over residues you wish to select.

Selected residues will be highlighted in the workspace and graphics window

Any selection is highlighted in the workspace as well as in the 3D graphics window if the structure is displayed.

### OPTION 2:

- Click on the **rectangular selection** icon or **lasso selection** icon on the toolbar.
- Click and drag around the residues you wish to select. Selected residues will be displayed by green crosses on the graphical display and blue in the ICM workspace.
- Click on the Pick Atom button.

### OPTION 3:

- Right click on the selected residue in the graphical display and a menu as shown here will be displayed.

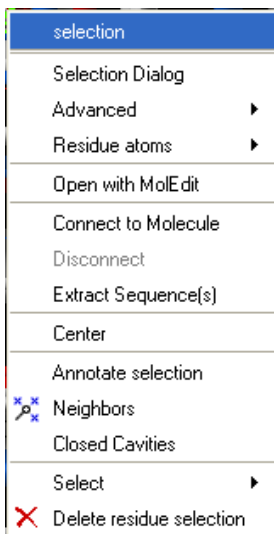

- Click on **Select** and a further menu will be displayed.
- Click on **Residue, Molecule** or **Object**.

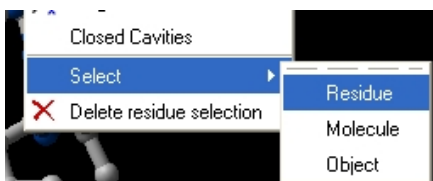

**NOTE:** Ctrl + A will select everything in the ICM workspace, and Ctrl + Shift + A will unselect your objects.

**NOTE:** The selection you have made is always recorded at the top of the ICM workplace. If you are familiar with using the ICM terminal (See language manual) the atoms, residues, molecules or objects selected interactively in the graphics window are automatically s

## 2.2.11 Selecting Neighbors

In some instances you may only want to display or select only a subset of a structure. For example you may only wish to display the residues surrounding a ligand (as shown below (ligand red; graphical selection green crosses)). The "Selecting Neighbors" option selects the residues within a sphere of a defined radius.

There are two ways of selecting neighbours to a particular atom or residue in ICM. Either by right clicking on the atom or residue in the graphical display or by right clicking in the ICM workspace.



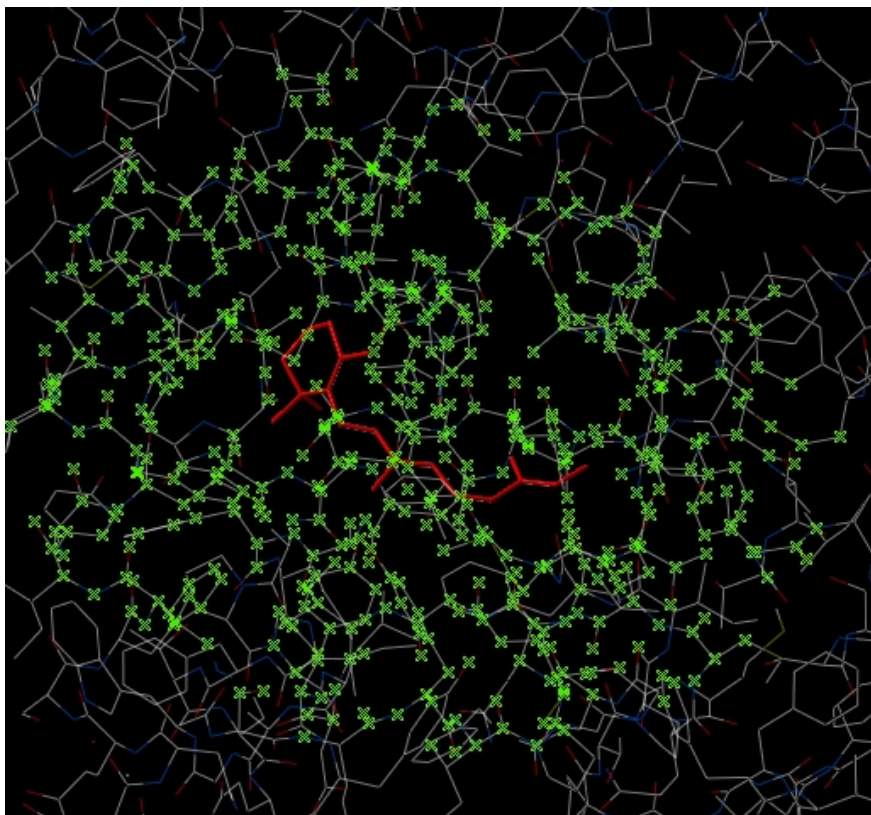

## 2.2.12 Selecting Neighbors: Graphical

*To select neighboring atoms or residues around a sphere of a certain radius:*

- First select the residue(s) or atom(s) around which you wish to select neighbors. (See the Selection Toolbar Section)
- Right click on the selection and a menu as shown below will be displayed or choose Tools/Geometry/Neighbors.

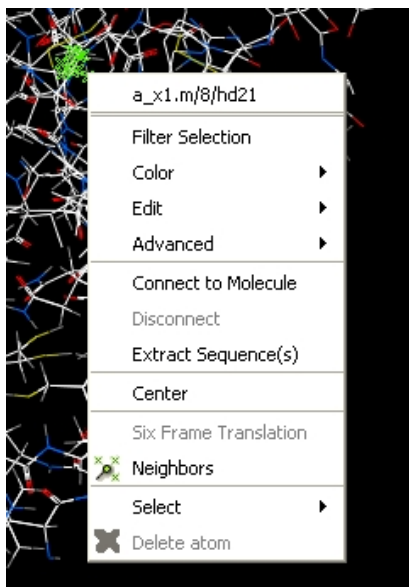

- Select the Neighbors option and a data entry box as shown below will be displayed.

This option will allow you to make a spherical selection.

The window will open as displayed as below:



- Select the molecule you wish to select neighbors around. For example you can select a ligand in the ICM workspace and then choose the **Graphical Selection** option in the "Select Neighbors For" dialog entry box. Or alternatively you can select the object by clicking on the drop down button next to the "Select Neighbors For" dialog entry box.
- Enter the radius in Angstroms for the neighbor selection. e.g. 5.
- **Type** – this option is **important**. This option relates to what is going to be selected. For example if you leave this option as **visible** and you only have ribbon representation displayed for your receptor (e.g. when selecting neighbors for a ligand) then only backbone atoms will be selected.

Selection **Type** option includes:

- **visible** – will select all atoms displayed within the radius selected.
- **visible sidechains** will select all visible side-chains – not backbone atoms.
- **same\_object\_other\_chains** will select all atoms in other chains in the same object as the original selection.
- **other objects** will select atoms in objects other than the original selection.
- **same object** will select atoms in the same object as the original selection.
- **all\_objects** will select atoms in all objects
- **choose\_from\_list** will allow you to select the object you wish to include in the neighbors selection.
  
- **exclude source** if checked will not include your original selection in the spherical selection.
- **unselect water** if checked will not select water molecules
- **Undisplay Beyond Selection** will only display the atoms selected.

**NOTE:** The selection you have made is always recorded at the top of the ICM workplace. If you are familiar with using the ICM terminal (See language manual) the atoms, residues, molecules or objects selected interactively in the graphics window are automatically saved in the variable as `_graph`. Graphical selections are shown in green (crosses) or highlighted in blue in the ICM Workspace.

## 2.2.13 Selecting Neighbors: Workspace

*To select neighboring atoms or residues around a sphere of a certain radius from a residue in the ICM workspace:*

- First select the residue in the ICM workspace around which you wish to select neighbors. (See the Residue Selection)
- Right click on the selection and a menu as shown below will be displayed.

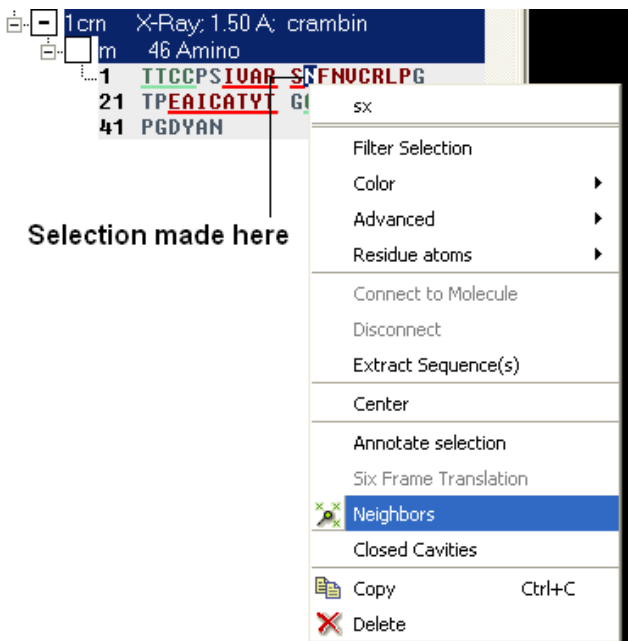

- Select the Neighbors option and a data entry box as shown below will be displayed.
- Follow the instructions in the previous section.

**NOTE:** The selection you have made is always recorded at the top of the ICM workplace. If you are familiar with using the ICM terminal (See language manual) the atoms, residues, molecules or objects selected interactively in the graphics window are automatically s

## 2.2.14 Alignment and Table Selections

Descriptions on how to make selections in Alignments and Tables are in the sections entitled Making Selections in Alignments and Making Table Selections.

## 2.2.15 Making Links

It is sometimes necessary to make links between sequences objects and alignments. A link enables you to make selections in one environment such as an alignment and then these selections are transferred to the object such as the PDB structure displayed.

If a link is made then a symbol will be displayed next to the object in the ICM workspace. In the example shown below subunit\_a of the X-ray structure 1ql6 is linked to the sequence 1ql6\_a and the alignment called 'alig'.

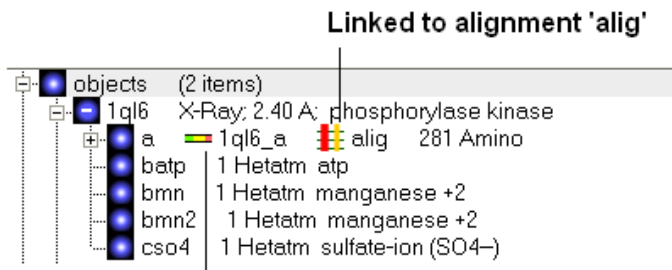

### Linked to sequence 1ql6\_a

If an object is linked to an alignment a symbol as shown below will be displayed.

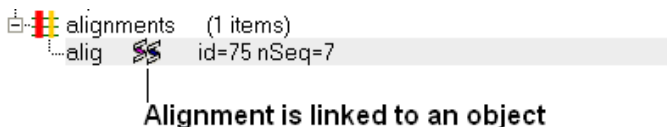

To link a sequence from an object – extract the sequence from the object.

- Right click on the object in the ICM workspace.
- Select extract sequence.

To link a sequence and object to an alignment.

Use the extracted sequence as described above to build your alignment.

In addition a link can be made between a structure and alignment by:

- Bioinfo/Link to Structure.
- Enter alignment name.
- OK

## 2.3 Menu Option Guide

**Note:** Click **Next** (top right hand corner) to navigate through this chapter. Headings are listed on the left hand side (web version) or by clicking the **Contents** button on the left-hand-side of the help window in the graphical user interface.

Here we describe all the options in the drop down graphical user interface menus.



### 2.3.1 File Menu

## File Menu

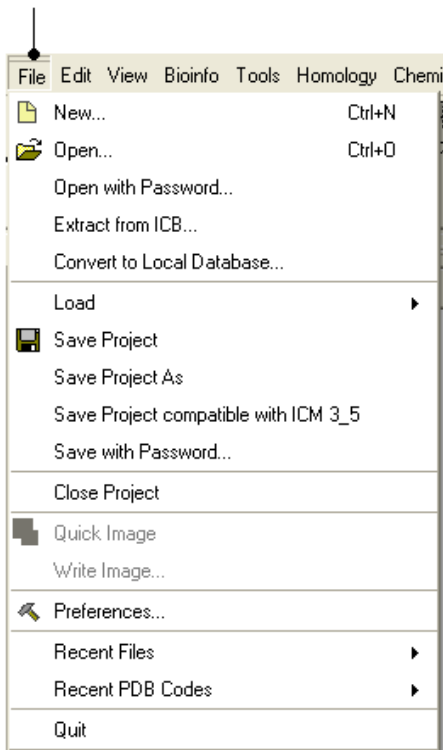

### 2.3.1.1 New

ICM can read as well as create several different entities. This dialog box helps you to create new entities from scratch:

All the processes in this section can be found under **File/New**, in the **New molecule/sequence/grob window**

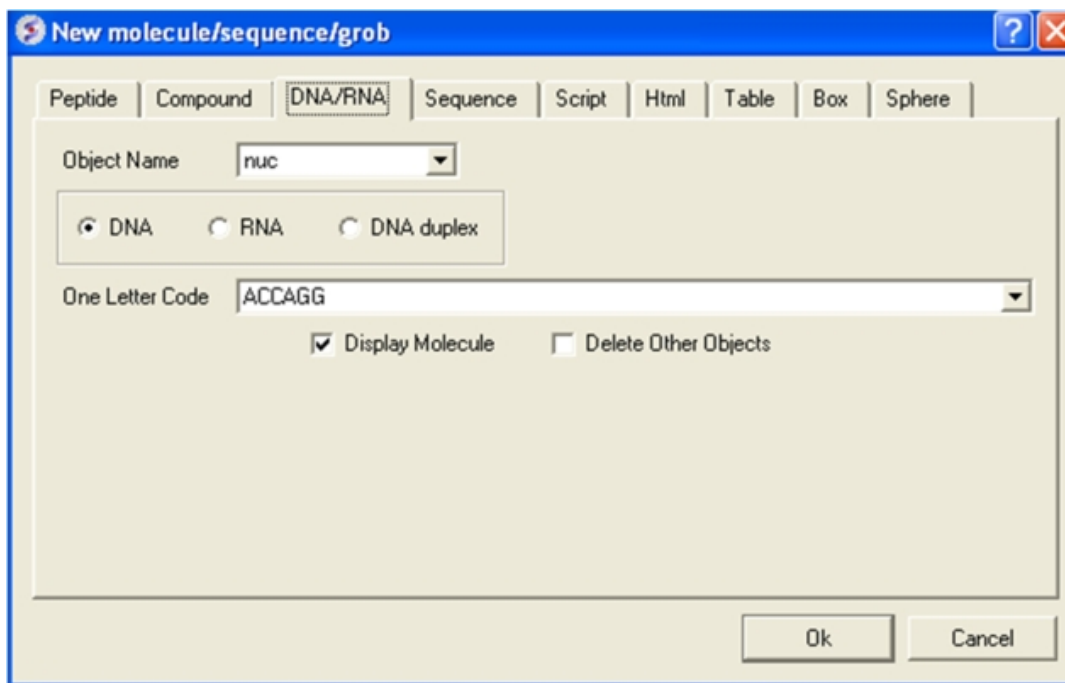

### 2.3.1.1.1 Constructing a New Peptide

Creates a peptide as a new ICM Object, named after the string entered in the 'Object name' field. The residue composition of the new peptide is the string entered in the 'One Letter Code' field. The chemical property of the peptide ends will be created according to the type of terminus chosen from the 'N-terminus' and 'C-terminus' drop-down list.

The peptide can be displayed immediately after creation (check the 'Display molecule' option). The new peptide can be folded as an alfa-helix ( $\phi = -62$  deg.;  $\psi = -41$  deg.), instead of a linear stretch of residues ( $\phi, \psi = 180$  deg.) (check the 'Assign A-helix' option).

Please note that the created peptide will not be in its most favorable energetic conformation.

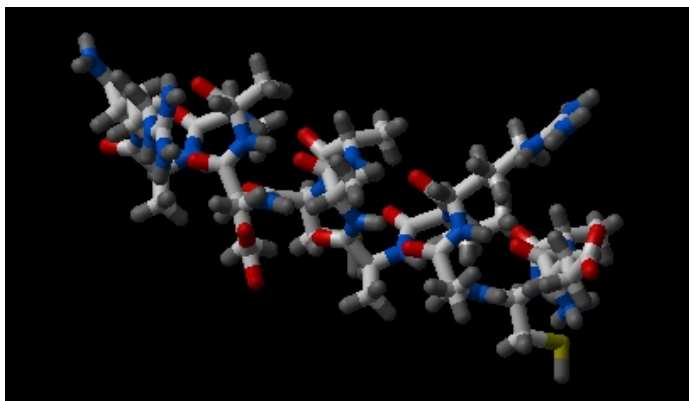

#### *To construct a new peptide:*

- Select **File/New** and the **New molecule/sequence/grob window** will appear.
- Type the peptide sequence into the One letter code data entry box. Remember to delete the previous entry if it is in the box.

NOTE: If the peptide you wish to make has been made previously then it will be in the drop down menu in the One letter code box.

- Select the appropriate N-terminal and C-terminal from the drop down menu.
- Check the boxes **Display Molecule** or **Assign A-Helix** according to your particular preference.
- Click the **OK** button.

### 2.3.1.1.2 Constructing a New Compound

Creates a compound/ small chemical molecule, based on the SMILES – Simplified Molecular Input Line Entry Specification – string supplied. The name of the compound can be specified on the 'Object name' field. For further information on SMILES syntax  
<http://www.daylight.com/dayhtml/smiles>.

The new compound can be displayed immediately after creation (check the 'Display molecule' option). All other objects can be deleted before the creation of the new object (check the 'Delete other objects' option).

Please note that the created compound will not be in its most favorable energetic conformation.

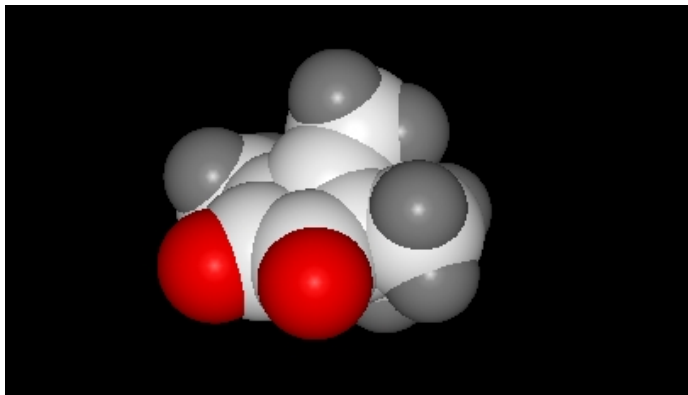

*To construct a new compound:*

- Select **File/New** and the New molecule/sequence/grob window will appear.
- Click the **Compound** tab at the top of the window.

**OPTION 1:**

- Type in the Smiles String in the Smiles String data entry box. Remember to delete the previous string. If a string has been entered previously it will be available by clicking on the drop-down button.
- Check the boxes **Display Molecule** or **Delete Other Objects** according to your preference.
- Click the **OK** button.

**OPTION 2:**

- Click the Launch Molecule Editor button.

Please refer to the `Molecule Editor` section of this manual for instructions.

### 2.3.1.1.3 Constructing New DNA or RNA

Creates a nucleic acid chain object – either DNA or RNA, according to the selection and the nucleotide sequence. The sequence should be supplied in one-letter code (ATCG) format, starting from 5' end. The name of the DNA/ RNA object can be specified on the 'Object name' field.

If the 'DNA duplex' option is selected, the complementary strand will be created automatically as a separate molecule in the same object.

The new DNA/ RNA can be displayed immediately after creation (check the 'Display molecule' option). All other objects can be deleted before the creation of the new object (check the 'Delete other objects' option).

Please note that the DNA/ RNA will be created as adopting the canonical B-DNA conformation.

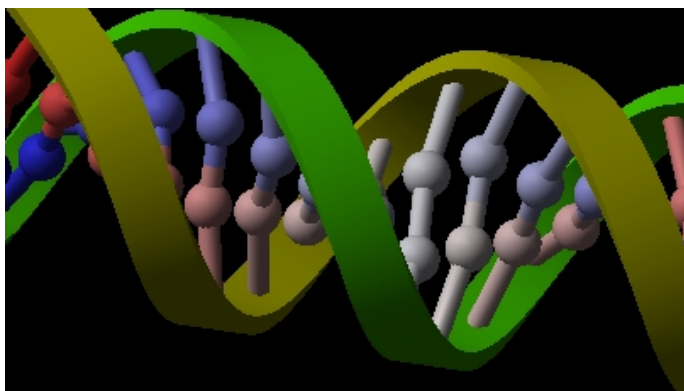

*To construct new strand of DNA or RNA:*

- Select **File/New** and the **New molecule/sequence/grob** window will appear.

- Click the **Nucleotide** tab at the top of the window.
- Check the appropriate box for the nucleotide you are constructing, either DNA RNA or DNA Duplex
- Enter the nucleotide sequence into the **One Letter Code** data entry box. Remember to delete the previous nucleotide sequence. If a sequence has been entered previously it will be available by clicking on the drop-down button.
- Check the boxes **Display Molecule** or **Delete Other Objects** according to your preference.
- Click the **OK** button.

#### 2.3.1.1.4 Constructing New Protein and Nucleic Acid Sequences

Creates a new Sequence using the information supplied by the user in FASTA format. The sequence type can be defined as protein or nucleic acid by the user, or automatically detected by ICM. Simply choose one of the options on the dialog box. The sequence name can be specified in the 'Sequence name'.

*To construct a new protein and nucleic acid sequence:*

- Select **File/New** and the **New molecule/sequence/grob** window will appear.
- Click the **Sequence** tab at the top of the window.
- Copy and paste a Fasta-format sequence into the Sequence data entry box.
- ICM will automatically determine what kind of sequence you have constructed but if you wish to specify then you can check either the protein or nucleic acid box.
- Click the **OK** button.

#### 2.3.1.1.5 Writing a Script in GUI.

Creates a clickable link on the workspace that launches scripts written using ICM language. The link is named after the 'Script Name'.

There are two ways of defining the script to be associated with the link. The first is to input the ICM script directly into the 'IcmCode' field. Alternatively, a file containing an ICM macro can also be associated with the link.

*To write a script in the graphical user interface:*

- Select **File/New** and the **New molecule/sequence/grob** window will be displayed.
- Click the **Script** tab at the top of the window.
- Write your ICM script in the text box provided (see below) and click OK.

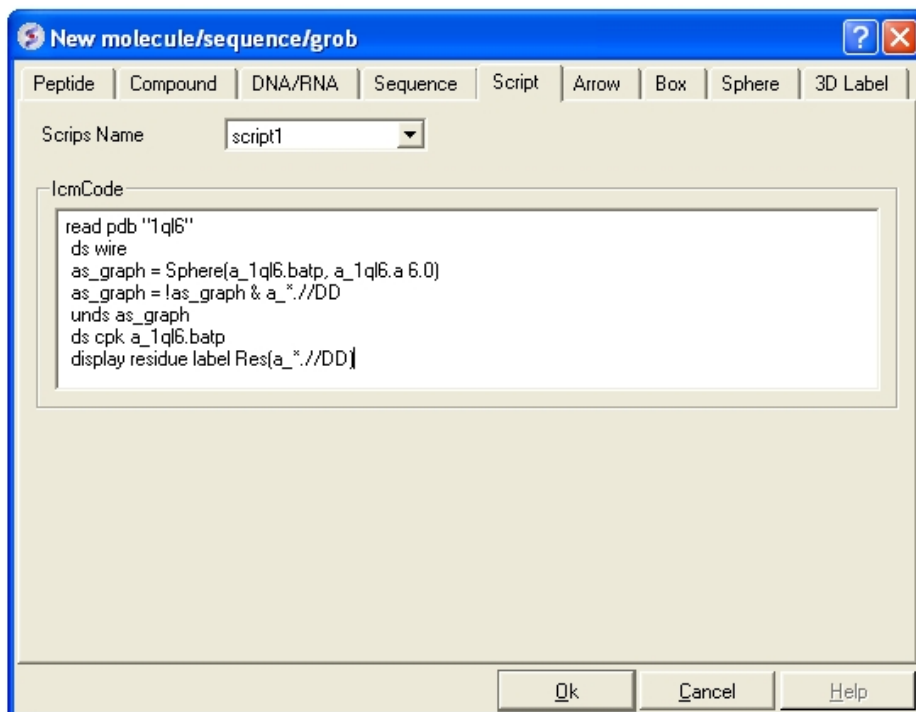



### *To run or edit your script:*

- Right click on the script name in the ICM workspace.

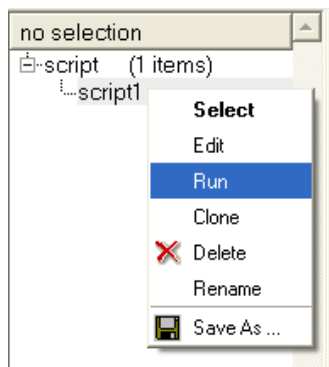

**NOTE:** For more details regarding the ICM scripting language please see the separate ICM language manual.

#### 2.3.1.1.6 HTML

- File/New HTML tab provides a window to enter HTML code. This window is a good starting point for generating new molecular documents.

#### 2.3.1.1.7 New Table

##### *To generate a new empty table:*

- File/New and select the **Table** tab and a window as shown below will be displayed.
- Enter the number of rows and columns you wish to include in your table and whether you wish to add a column with chemical data.

#### 2.3.1.1.8 arrow

Creates a 3D arrow as a new graphical object ('grob' or 'mesh'). This arrow can be generated both as a solid object or as a simpler line representation. The name of the object can be defined in the 'Arrow Name' field.

The start (StartXYZ) and end (End XYZ) points of the arrow are defined in cartesian coordinates (X, Y, Z). The quality of the arrow can be adjusted (the higher the value, the smoother the arrow will be). Color can be assigned by simply clicking on the desired one or using rgb scale (eg. for red:  $\text{rgb}=\{1. 0. 0.\}$ ).

The Arrow Radius is defined in Angstroms. The size of the head, shown as a solid cone is defined as a fraction of the whole length of the arrow. Thus 0.1 means that the height of the head will take 10% of the total size of the arrow, while 1.0 means that the head will take the whole arrow (resulting in a shaftless arrow). The width of the head refers to the diameter of the head cone and it is defined as a multiplier of the Arrow Radius.

Tip: the arrow can be moved independently using 'connect'

#### 2.3.1.1.9 Box

Creates a 3D box as a new graphical object ('grob' or 'mesh'). This box can be generated both as a solid object or as a simpler wire representation. The name of the box can be defined in the 'BoxName' field.

Dimensions of the box (X, Y, Z) are given in Angstroms and the angles connecting the sides are given in degrees. Color can be assigned by simply clicking on the desired one or using rgb scale (eg. for red:  $\text{rgb}=\{1. 0. 0.\}$ ).

Tip: the box can be moved independently using 'connect'

### 2.3.1.1.10 sphere

Creates a 3D sphere as a new graphical object ('grob' or 'mesh'). This sphere can be generated both as a solid object or as a simpler wire representation. The name of the sphere can be defined in the 'BoxName' field.

Dimensions of the sphere (X, Y, Z) are given in Angstroms and the angles connecting the sides are given in degrees. Color can be assigned by simply clicking on the desired one or using rgb scale (eg. for red: `rgb={1. 0. 0.}`).

Tip: the arrow can be moved independently using 'connect'

### 2.3.1.2 Open

Any file that ICM can understand can be opened by:

- Selecting File/Open.

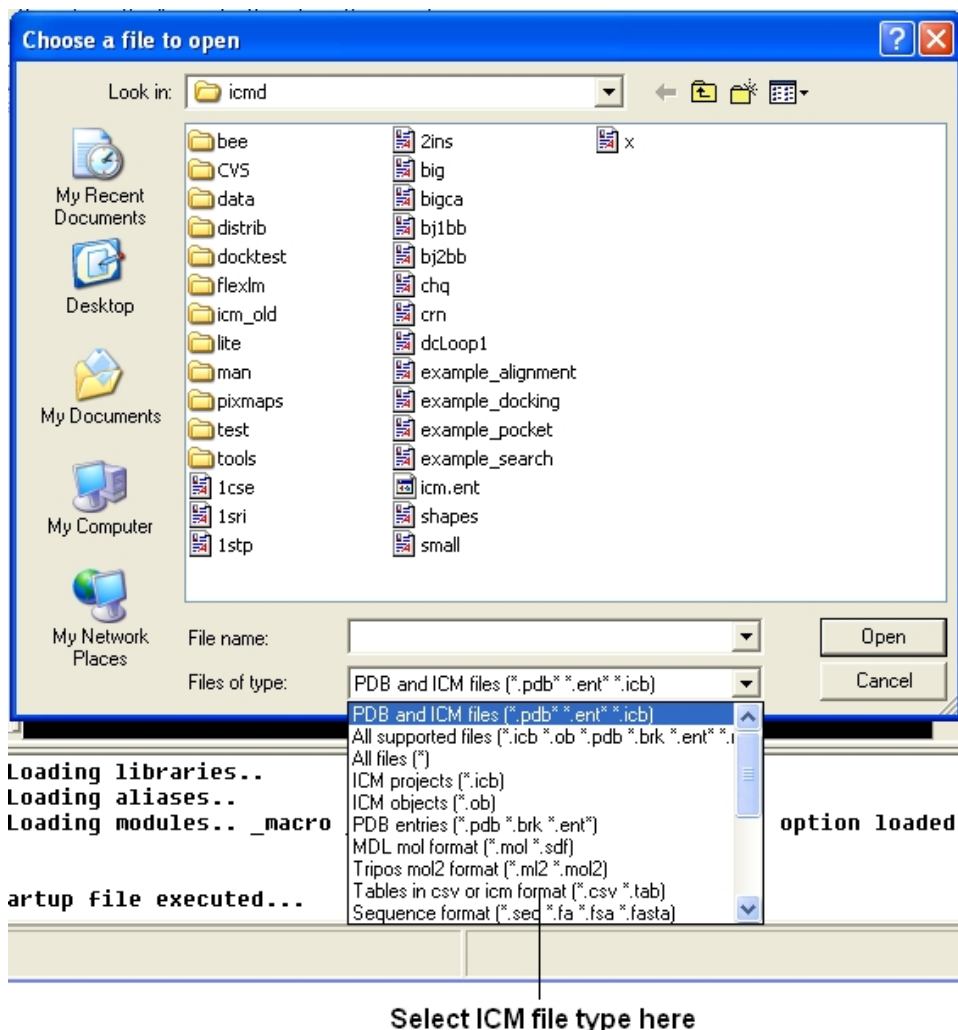

### 2.3.1.3 Open with Password

To open a file that is password protected:

- File/Open with Password

### 2.3.1.4 Extract from ICB

An **icb** file is an `icm project` file and this option allows you to view a tabulated list of what the `icb` file contains.

- File/ Extract from ICB
- Locate the saved `icb` file.
- A table as shown below will be displayed
- Double-click on any of the entry to extract that item from ICB

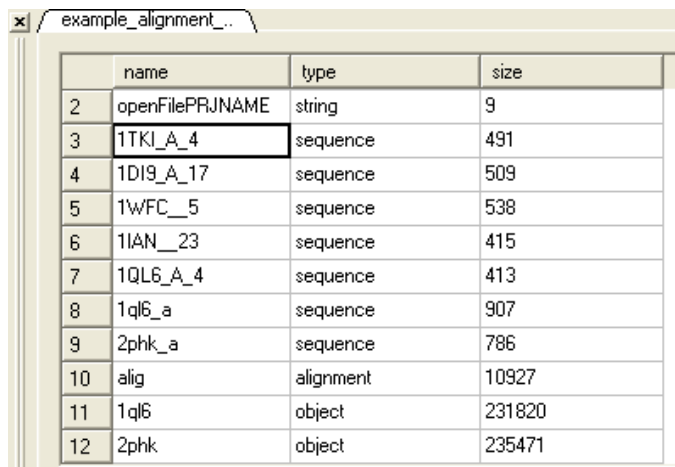

	name	type	size
2	openFilePRJNAME	string	9
3	1TKL_A_4	sequence	491
4	1DI9_A_17	sequence	509
5	1WFC_5	sequence	538
6	1IAN_23	sequence	415
7	1QL6_A_4	sequence	413
8	1ql6_a	sequence	907
9	2phk_a	sequence	786
10	alig	alignment	10927
11	1ql6	object	231820
12	2phk	object	235471

### 2.3.1.5 Convert to Local Database

Please see the `Local Databases` chapter for more information about this option.

### 2.3.1.6 Load

*Options* contained within the menu `File/Load`

**PDB** – read PDB from FTP, http, and local PDB

**From Multiple Object File** – A multiple object file will have a file extension `*.ob` and you can select which member of the multiple object is displayed.

**PFam Alignment** – PFam is a collection of multiple sequence alignments – enter FASTA ID

**SwissProt** – Download SwissProt sequence.

**All Images from Dir** – Read into ICM multiple image files `png` or `jpg`.

**Electron Density Map** – Download electron density map from Uppsala electron density server <http://eds.bmc.uu.se/eds/>

**3D Mesh in KMZ or COLLADA Format from Google** – see <http://sketchup.google.com/3dwarehouse/> to download KMZ or COLLADA.

### 2.3.1.7 Save Project

Saving a project will allow you to quit from ICM and then return to the exact set-up and display at which you left off at a later date. The projects are saved in files with the extension `*.icb`

*To save a project:*

- Select **File/Save Project** and a data entry window will be displayed. This window will only appear if this is the first time you have saved a project.
- Enter the unique name you wish to call your project in the box labeled **File name:**

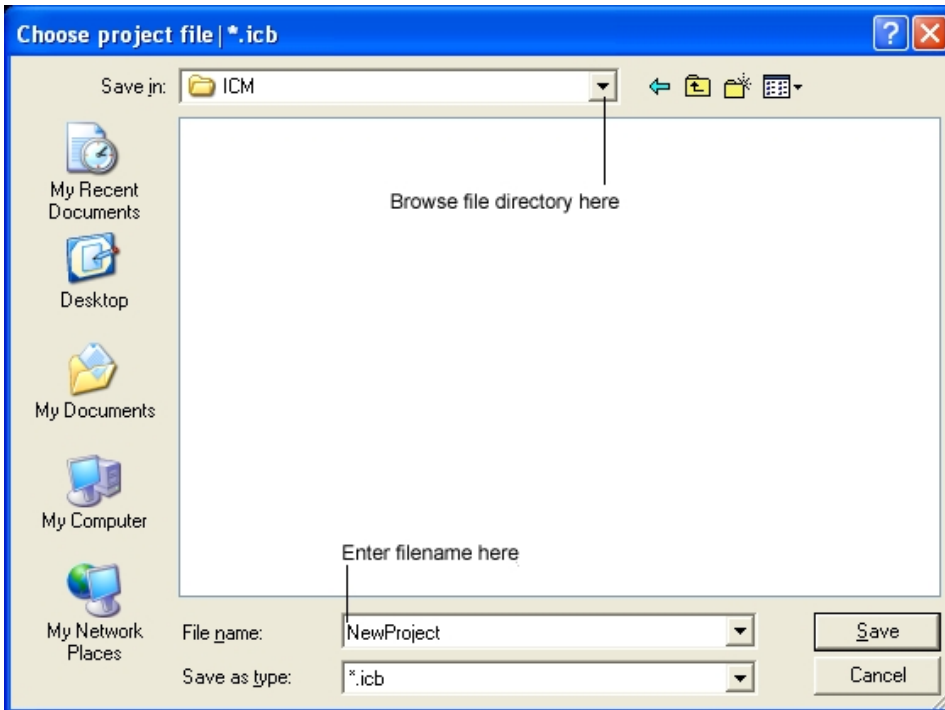

- Choose which folder or directory you wish to save your project in by scrolling down in the box labeled **Save in:**
- Once the appropriate information has been entered click on the **Save** button in the bottom right hand section of the window.
- The project is now saved as yourfilename.icb.

**NOTE:** An alternative way to save a project is to click on the save icon on the toolbar.



### 2.3.1.8 Save Project As

If you wish to re-name the project or save different versions of the same project use the **Save Project As** option.

To rename a project:

- Click on the **File/Save Project** option and a data entry window will be displayed. This window will only appear if this is the first time you have saved a project.
- Enter the unique name you wish to call your project in the box labeled **File name:**
- Choose which folder or directory you wish to save your project by scrolling down in the box labeled **Save in:**
- Once the appropriate information has been entered click on the **Save** button in the bottom right hand section of the window.
- The project is now saved as yourfilename.icb.

#### 2.3.1.8.1 Reloading a Saved ICM Object when ICM is Running

Once an ICM object has been saved you can re-read it by:

- Click on **File/Open** and a data entry window will be displayed (below).
- Locate your saved ICM Object by clicking on the **Browse** button in the bottom right hand section of the window.

**NOTE:** To make your search easier you can limit the number of files you search through by scrolling down in the Open as section and selecting the appropriate file ending.

- Click on the **OK** button when the file has been located and your saved ICM Object will load.

**NOTE:** If the file you wish to load has been viewed recently then it will be in the drop down menu in the Open box.

#### 2.3.1.8.2 Reloading a Saved ICM Object in Windows when ICM is not Running

To reload a saved project in Windows simply find the file in the "My Computer" file store and double-click on the icon.

#### 2.3.1.9 Save Project Compatible with ICM 3\_5

##### File/Save Project Compatible with ICM 3\_5

Use this option to save a version of your ICM project compatible with an older version of ICM. Version 3.5 or older. If you have an ICM license you can update your version of ICM by visiting our support site at [www.molsft.com/support](http://www.molsft.com/support)

#### 2.3.1.10 Save with Password

To save a project which is protected by a password:

- File/Save with Password
- Enter a file name or browse for a previously saved project.
- Enter a password
- Determine whether you want the file to be **Fully Protected, read only** or **Read Only and Allow Comments**.

#### 2.3.1.11 Export as ActiveICM Html

To embed in a web browser.

1. Download ActiveICM from here  
[http://www.molsoft.com/getbrowser.cgi?product=activeicm\(it is free!\)](http://www.molsoft.com/getbrowser.cgi?product=activeicm(it is free!)).
2. Create an HTML page in ICM (File/New/Html).
3. Add a series of slides.
4. File/Export As ActiveICM Html..

#### 2.3.1.12 Close Project

To close a project:

##### File/Close Project

#### 2.3.1.13 Quick Image

A quick image can be saved using this option. The image will be saved as `icm1.png` in the current directory in which you are working. Each subsequent image produced will be incrementally numbered.

This option is also available via a button as shown below:

### Quick image button

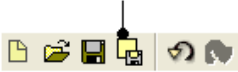

### 2.3.1.14 Write Image

Before saving an image it is best to improve the quality of the image using the "High Quality Image" and antialias buttons shown below.

#### antialias



#### high quality image

To save and write an image:

- Select **File/Write Image** and the following window will be displayed:

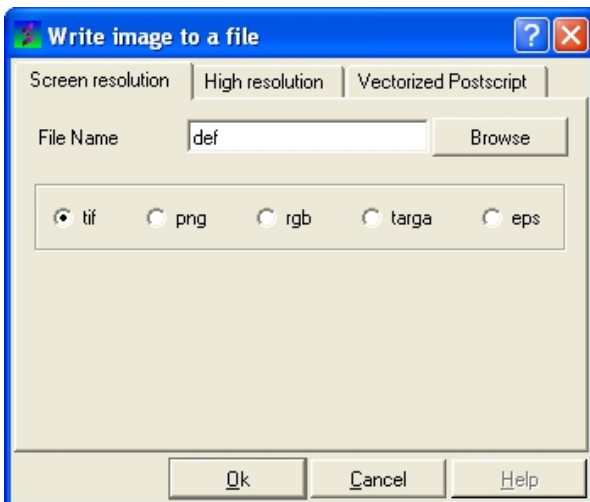

- Enter the name for the picture in the **File name** data entry box.
- Select which file format you would like to save the picture in by clicking in the circular selection button next to the file types. The options are .tif; .png; .rgb; .targa .eps.
- To specify which resolution you wish the picture to be saved click on the **High resolution** button at the top of the panel.
- Click the drop down arrow in the **Resolution Increase** data entry box and select which resolution you require the picture to be. Alternatively you can type the resolution you require into this box.

**NOTE:** A quick way to save an image is to use the Quick Capture Graphics button on the toolbar which is described in the *Picture Tips* section of this manual.

### 2.3.1.15 Preferences

*Your ICM preferences can be changed by:*

- Select File/Preferences.

**NOTE:** There is a "Reset to Default" button in case you make any changes you are not happy with.

### 2.3.1.15.1 Bonds Preferences

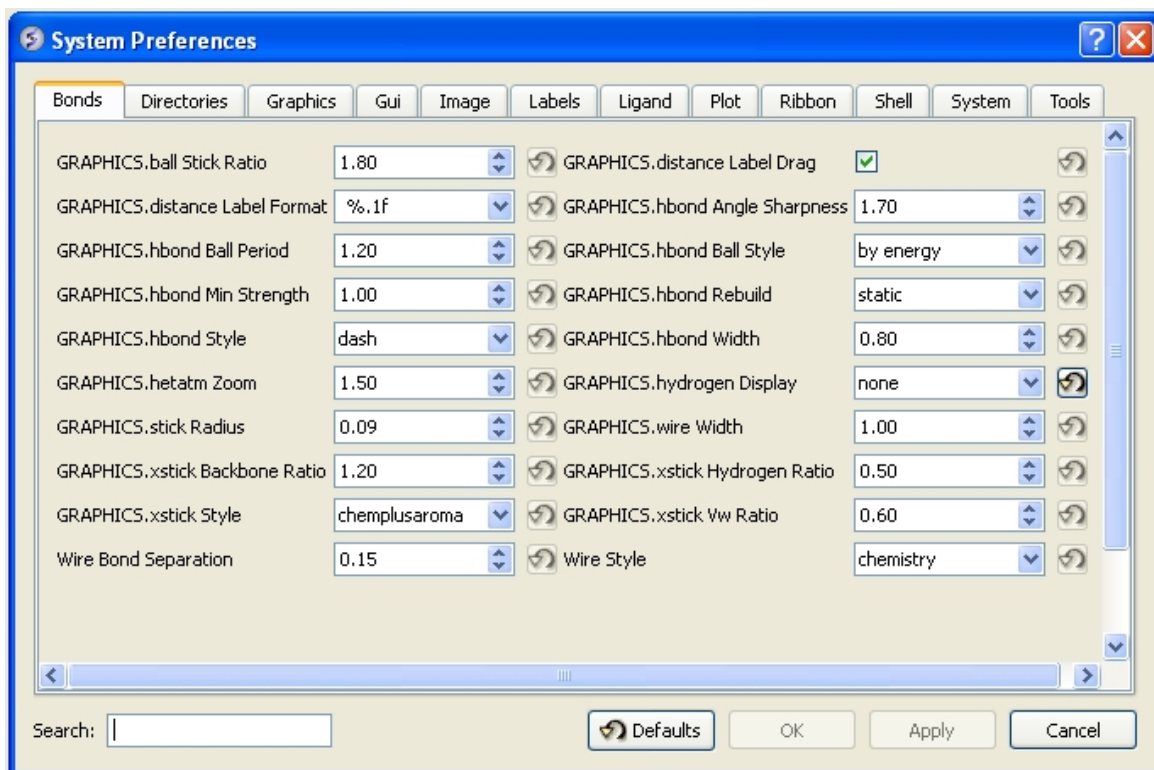

**GRAPHICS.ballStickRatio** – A default ratio of ball and stick radii. This ratio is applied when the styles are switched from the GUI xstick toolbar. Default (1.4)

**GRAPHICS.hbond Ball Period** – Default (3)

**GRAPHICS.hbondMinStrength** – parameter determines the hbond strength threshold for hbond display. The strength value is between 0. and 2. By changing 1. to 0.2 you will see more weak hydrogen bonds. Default: (1).

**GRAPHICS.hbondStyle** – determines the style in which hydrogen bonds are displayed. Here hbond–Donor, Hydrogen, and hbond–Acceptor atoms will be referred to as D, H and A, respectively,

**GRAPHICS.hetatmZoom** – The default ball and stick radii of a ligand can be different by the GRAPHICS.hetatmZoom factor. This makes a better ligand view since the ligand stands out from the surrounding protein atoms.

**GRAPHICS.stickRadius** – radius (in Angstroms) of a cylinder displayed as a part of stick or xstick graphical representation of a molecule. Individual (residue–wide) control of stick radii.

**GRAPHICS.xstick Backbone Ratio** – Default (1.2)

**GRAPHICS.xstick Style** – xstick style

**wireBondSeparation** the distance between two parallel lines representing a chemical double bond if wireStyle = "chemistry". Default (0.2 Angstroms).

**GRAPHICS.distance Label Drag** – enable distance label dragging

**GRAPHICS.hbondAngleSharpness** determines how the strength depends on the D–H...A(lone pair) angle. The preference can be found the general Preferences menu Default (1.7)

**GRAPHICS.hbond Ball Style** even, by atom size, by energy or telescopic

**GRAPHICS.hbond Rebuild**

**GRAPHICS.hbondWidth** relative width of a displayed hbond .

**GRAPHICS.hydrogenDisplay** determines the default hydrogen display mode for the display command.

```
GRAPHICS.hydrogenDisplay = "polar"  
1 = "all" # all hydrogens are shown  
2 = "polar" <-- current choice # polar displayed, the non-polar hidden  
3 = "none" # no hydrogens are displayed
```

**GRAPHICS.wire Width** – relative width of wire Default (1)

**GRAPHICS.xstick Hydrogen Ratio** – Default (0.5)

**GRAPHICS.xstick Vw Ratio** – Default (0.6)

**Wire Style** – change the default wire style

```
GRAPHICS.hbondStyle = "dash"  
1 = "wire" # Just a line  
2 = "chemistry" # shows different types of chemical bonds.  
3 = "tree" # shows a directed graph of the ICM-molecular tree  
4 = "aromatic" #
```

### 2.3.1.15.2 Directories Preferences

**DIRECTORIES TAB:**



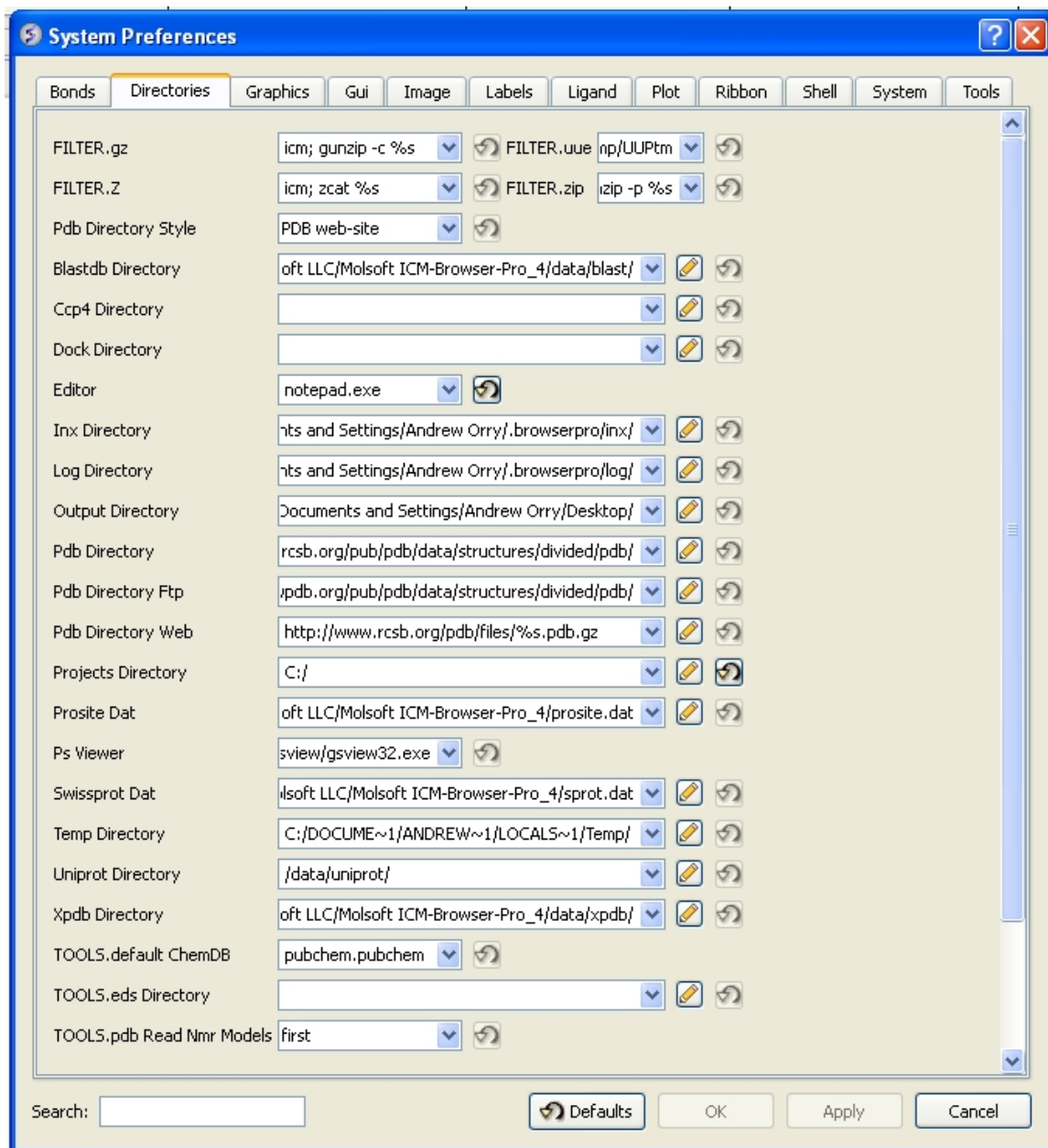

Within this tab you can select the default directories for:

***FILTER.gz***, ***FILTER.uue***, ***FILTER.Z***, ***Filter.zip*** allows you to read compressed files .gz, .uue, .Z, and .zip files automatically leaving the compressed file intact.

***PDB Directory Style*** – The style of your Protein Data Bank directory/directories. ICM will understand all of the listed styles, including distributions with compressed \*.gz, \*.bz2 and \*.Z files

***BlastDB Directory*** – return directory with Blast-formatted sequence files for ICM sequence searches. You can download Blast formatted databases from here <ftp://ftp.ncbi.nih.gov/blast/db/>

***Dock Directory*** – Default directory for storing docking files.

***CCP4 Directory***

***Editor*** – Select a default text editor

***Inx Directory*** – location of stored index (\*.inx) files.

**Log Directory** – when you quit an icm-session, a `_seslog.icm` file is automatically stored. If the `s_logDir` variable is empty, it is stored to the `s_userDir + "/log/"` directory. However one can redirect it to the current working directory ( `"."` ) or any other directory.

**Output Directory** –

**PDB Directory** – directory containing the PDB database of 3D structures. These files can also be easily downloaded directly from the PDB site if the variables are set as in the example below. PDB distributions can exist in several styles (all files in the same directory, or divided etc.).

**PDB Directory FTP**

**PDB Directory Web**

**Projects Directory** – Select the default location for storing ICM projects. Save your data in an ICM project. It is a convenient way of keeping all your structures, alignments, tables, docking results etc... in one place. A description on how to save an ICM project is described in the `GUI Basics` section of this manual.

**Prosite Dat** – location of the `prosite.dat` file a dictionary of protein sites and patterns, (Copyright by Amos Bairoch, Medical Biochemistry Department, University of Geneva, Switzerland).

**Ps Viewer** – Select a postscript viewer

**Swissprot Dat** – location of `swissprot.dat` file

**Temp Directory** – scratch directory for temporary files ( some montecarlo files will be saved there ).

**Uniprot Dat** – location of `uniprot.dat` file

**XPDB Directory** – Path to the ICM XPDB database of compact binary ICM objects which are annotated with the site information. The advantage of the XPDB database is the speed of reading and smaller size than PDB. XPDB entries are read about 80 times faster!

**TOOLS.default ChemDB**

**TOOLS.eds Directory**

**TOOLS.pdb Read Nmr Models**

1. = "first" : reads only one model from a multi-model (e.g. NMR) pdb file
2. = "all" : reads all models from a multi-model (e.g. NMR) pdb file and creates a separate
3. = "all stack" : creates one object and loads all other models as a stored cartesian stack

### 2.3.1.15.3 Graphics Preferences

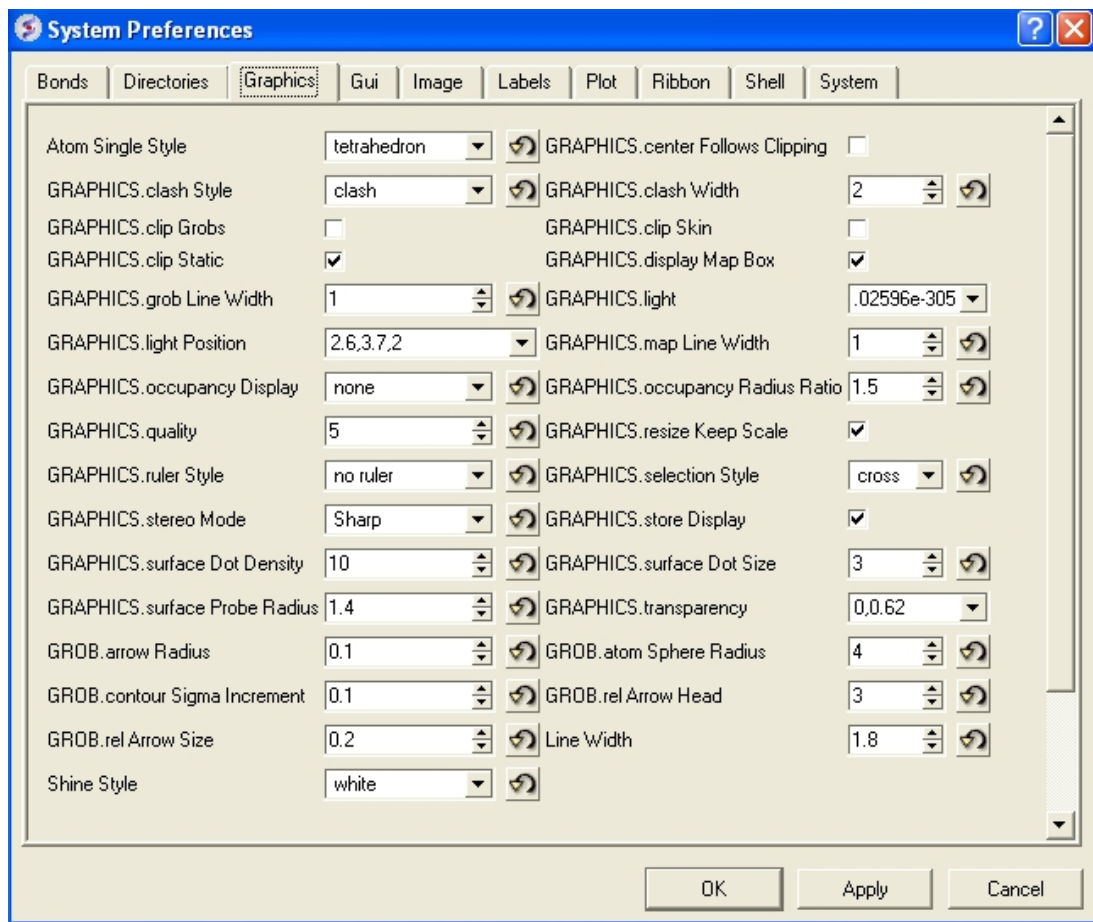

**Atom Single Style** – display style of isolated atoms in the wire mode.

1. "tetrahedron"
2. "cross"
3. "dot"

**GRAPHICS.clash Style** – choose clash length, strain or length.

**GRAPHICS.clip Grobs** – enable grob clipping.

**GRAPHICS.clip Static** –

**GRAPHICS.grobLineWidth** – relative width of displayed lines of 3D meshes ( grobs ). Also affects the interatomic distance display.

**GRAPHICS.lightPosition** – X ,Y and Z position of the light source in the graphics window. The X and Y coordinates are usually slightly beyond the [-1. 1] range where [-1.,1.] is the size of the window, and the Z position is perpendicular to the screen and is set to 2. (do not make it negative).

**GRAPHICS.occupancyDisplay** preference controlling if and how the partial or zero atom occupancies are displayed. The abnormal occupancies are shown as circles around atoms. These following values are allowed.

1. = "none" # nothing is displayed
2. = "circle" # a circle is displayed
3. = "label" # a circle and a label with the value (zero values are not shown)

**GRAPHICS.quality** – integer parameter controlling quality (density of graphical elements) of such representations as cpk, ball, stick, ribbon . Do not make it larger than about 20 or smaller than 1.

**GRAPHICS.ruler Style** – change ruler from center to side

**GRAPHICS.stereoMode** – 1. "up-and-down", 2. "line interleaved" 3. "in-a-window"

\*a simple hardware stereo mode for workstations with a horizontal frame splitter. \*In the "up-and-down" mode a longer frame with two stereo images on top of each other is generated and the two halves are then superimposed with the splitter. This mode does not require anything from a graphics card, but does require a frame splitter. A frame splitter box was connected between a monitor and a graphics card output. This mode has an unpleasant side effect, the rest of the screen (beyond the OpenGL window) becomes stretched and the lower part of the screen is superimposed on the top half. \*The "line interleaved" mode can be used with a new type of frame splitter at the line level. In this case the odd lines from one stereo-image are interleaved with the even lines of another. The side-effect of this mode is that the intensity is reduced in half since at each moment one sees only one half of the lines. The splitter device for this mode can be purchased from Virex ([www.virex.com](http://www.virex.com)). This mode produces a dark stereo image but is easily available (requires stereo goggles, e.g. from Virex). \*The "in-a-window" mode is used in SGI workstations and in a Linux workstation with an advanced graphics card supporting a quad graphics buffer. In this mode the hardware stereo regime applies only to an OpenGL window. This is the best mode but it requires an expensive graphics card (plus the stereo goggles).

**GRAPHICS.surfaceDotDensity** – Determines the number of dots per square Angstrom on the graphical solvent accessible surface.

**GRAPHICS.surfaceProbeRadius** – An increment to the van der Waals radii of atoms at which the dotted atomic surface is calculated. It is used by the display surface command to display dotted van der Waals surface. If the GRAPHICS.surfaceProbeRadius is set to 1.4 the surface becomes equivalent to the solvent accessible surface with a probe of 1.4A

**GROB.arrowRadius** – a real arrow radius in Angstroms used by the Grob( "ARROW", R\_ ) function. Default: 0.5.

**GROB.contourSigmaIncrement** – a real increment in the sigma level used to re-contour an electron density map using the make grob m\_edds add r\_increment command. This parameter is used in the GUI when plus and minus are pressed.

**GROB.relArrow Size** – a real ratio of the arrow head radius to the arrow radius. This parameter is used by the Grob( "ARROW", R\_ ) function. Default: 3.0.

**shineStyle** – defines how solid surfaces of cpk , skin and grobs reflect light. Possibilities:

1. "white" <- default
2. "color"

The first option gives a more shiny and greasy look.

**GRAPHICS.center Follows Clipping** – determine the function of center button.

**GRAPHICS.clashWidth** – relative width of a displayed clash .

**GRAPHICS.clip Skin** – enable skin clipping.

**GRAPHICS.displayMapBox** – controls if the bounding box of a map is displayed

**GRAPHICS.light** – a rarray of 13 elements between 0. and 1. which controls the main properties of lighting model in GL.

**GRAPHICS.mapLineWidth** – relative width of lines and dots of a displayed map.

**GRAPHICS.occupancy Radius Ratio** – preference controlling the radius of the partial or zero atom occupancies

**GRAPHICS.resize Keep Scale**

**GRAPHICS.selectionStyle** – preference for the style in which the graphical selection is shown. The preference may have the following values.

**GRAPHIC.store Display** – maintains representation and coloring for an object.

**GRAPHICS.surfaceDotSize** – Determines the size of the dot on the solvent accessible graphical surface.

**GRAPHICS.transparency** – Two parameters regulating the transparency of grobs.

**GROB.atomSphereRadius** – default radius (in Angstroms) which is used to select a patch on the surface of a grob.

**GROB.relArrowHead** – a real ratio of the arrow head radius to the arrow radius.

**lineWidth** – the real width of lines used to display the wire representation of chemical bonds.

#### 2.3.1.15.4 GUI Preferences

##### GUI TAB:

The options contained within the Preferences/Gui tab are described below.

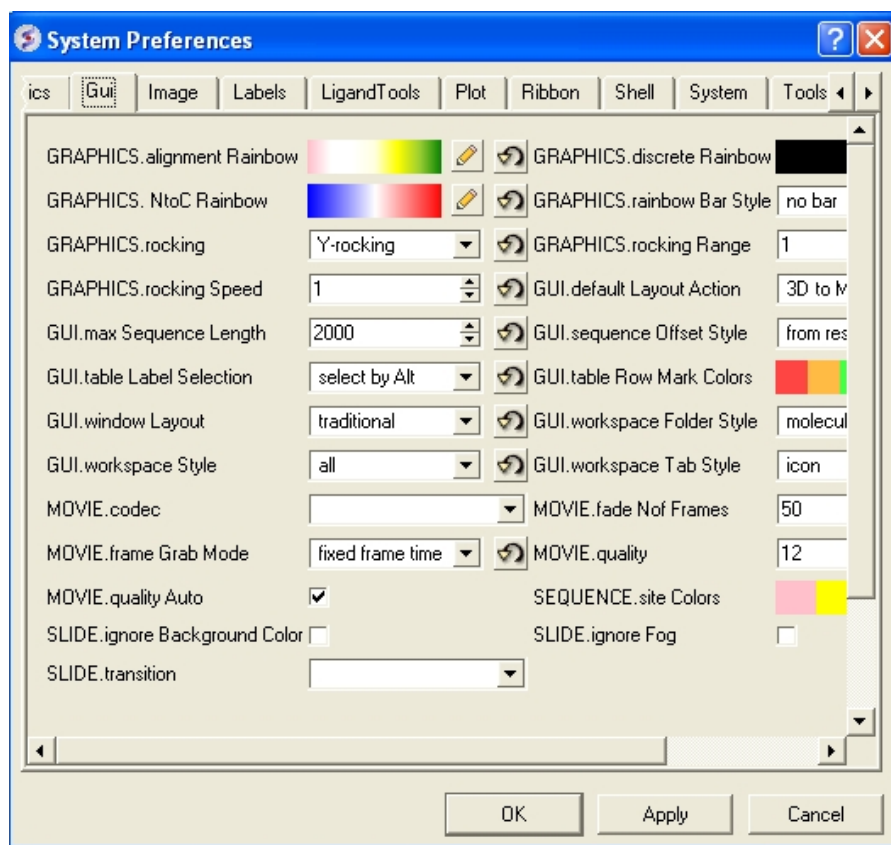

**GRAPHICS.alignment Rainbow** – This option controls how alignments are colored by default.

**GRAPHICS.NtoC Rainbow** – Controls the coloring of structural representation from the N-terminal to the C-terminal

**GRAPHICS.rocking** – Controls default rocking motion.

**GRAPHICS.rocking Speed** – Controls rocking or rotation speed.

**GUI.auto Save Interval** – Controls auto save period (minutes)

**GUI.table Row Mark Colors** – Controls colors used for marking tables.

**GUI.workspaceTabStyle** – Controls the style of ICM-object tabs created in the workspace panel of ICM GUI.

**Movie.fade Nof Frames** – Controls number of frames for the fade out option in screenshot movie making.

**Movie.quality** – Controls the resolution of the movie

*SEQUENCE.site Colors* – Controls coloring of sequence sites.

*SLIDE.ignore Fog* – Fog representations can be ignored in slide preparation if desired.

*GRAPHICS.discrete Rainbow* –

*GRAPHICS.rainbow Bar Style* – determines if and where the color bar will appear after a molecule is colored by an array.

*GRAPHICS.rocking Range* – real value of rocking range.

*GUI.auto Save* – auto save on or off

*GUI.max Sequence Length* – maximum sequence length displayed in ICM

*GUI.workspace Folder Style* – Workspace folder style.

*MOVIE.frame Grab Mode* – with screenshot movie making you can choose either fixed frame time or real time.

*Movie.quality Auto* – with screenshot movie making you can allow ICM to control the movie resolution.

*SLIDE.ignore Background Color* – Ignore background color when you are making a slide.

#### **2.3.1.15.5 General Preferences**

##### ***DISPLAY/GENERAL TAB:***

Here is a summary of the important options in the DISPLAY/GENERAL Preferences Tab.

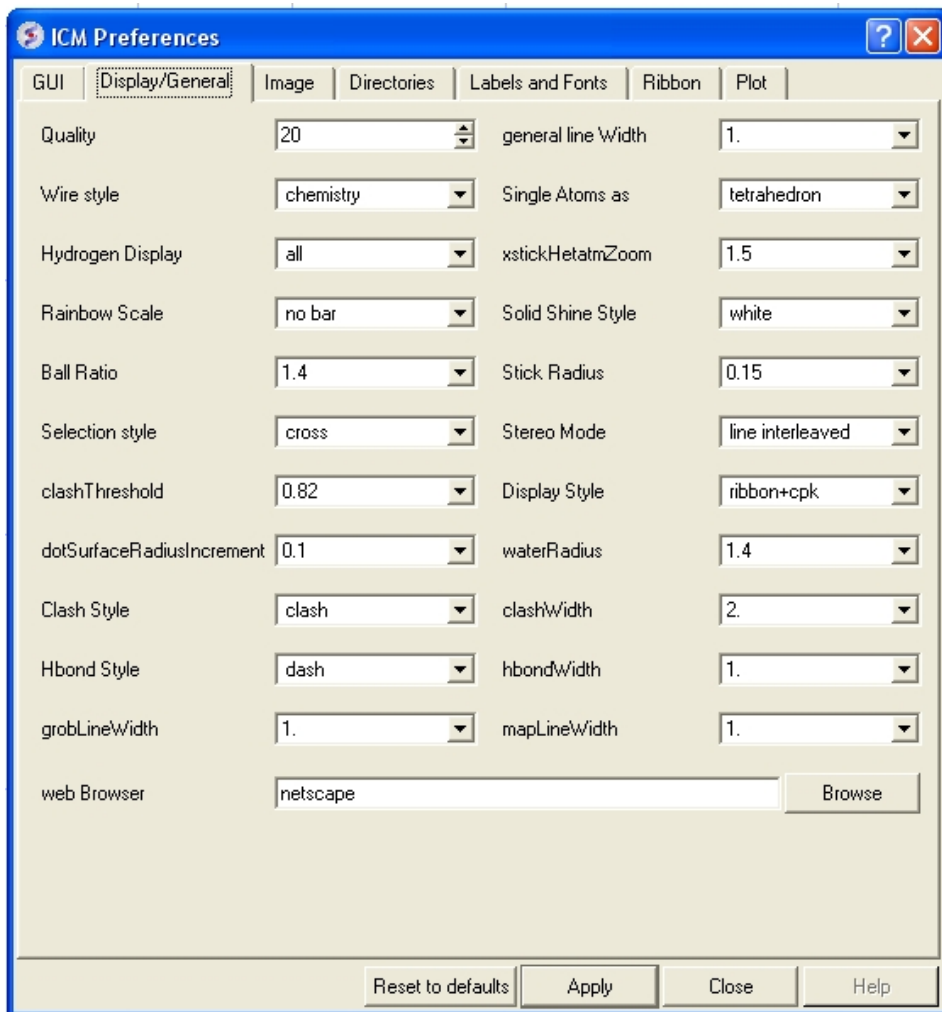

**Quality** – controls the quality (density of graphical elements) of such representations as cpk, ball, stick, ribbon. Do not make it larger than about 20 or smaller than 1. We recommend to make this parameter at least 15 if you want to make a high quality image. You can also increase the number of image resolution by making the image window 2,3,4 times larger (in the example below it is 2 times larger) than the displayed window.

**Wire Style** – Four different wire styles are available.

**Hydrogen Display** – Select whether you always want all hydrogens displayed or just-polar hydrogens or no hydrogens at all.

**Rainbow Scale** – determines if and where the color bar will appear after a molecule is colored by an array. Coloring by an array is one of the options of the display and color commands.

1. = "left" <- default choice
2. = "right"
3. = "no text"
4. = "no bar"

**Ball Ratio** – The ratio of ball and stick radii. This ratio is applied when the styles are switched to xstick from the GUI xstick toolbar.

**Selection Style** – Change the graphical display of your selections. Default is a green cross.

**Clash Threshold** – a clash is defined as an interatomic distance less than a sum of van der Waals radii of two atoms of interest multiplied by the clashThreshold parameter. For hydrogen bonded atoms, the distance threshold is additionally reduced by 20%. Default = 0.82

**DotSurfaceRadiusIncrement** – radius of a probe sphere used to display a dotted surface of a molecule. All van der Waals radii are expanded by this value. `vwExpand=0` corresponds to the CPK surface, `vwExpand=1.4` corresponds to the water-accessible surface. Be aware of the difference between the `waterRadius` and `vwExpand` parameters: `waterRadius` is used in

- show energy "sf"
- show [area|volume] skin
- display skin while `vwExpand` is used in
- show [area|volume] surface
- display surface

Default (1.4).

**H Bond Style** – How do you wish your H-Bonds to be displayed by default? Dashes, Bond Length, Bond Length and Angle.

**grobLineWidth** – relative width of displayed lines of 3D meshes ( grobs ). Also affects the interatomic distance display.

**general line with** – the real width of lines used to display the wire representation of chemical bonds. See also `IMAGE.lineWidth` parameter which controls line thickness in molecular images generated by the `write` postscript command, and the `PLOT.lineWidth` which controls the width for the `plot` command. Default (1.0)

**single atom as** – display style of isolated atoms in the wire mode.

1. "tetrahedron"
2. "cross"
3. "dot"

The size of the first two representation is controlled by the `GRAPHICS.ballRadius` parameter and

**xstickhetatomzZoom** – The default ball and stick radii of a ligand can be different. This makes a better ligand view since the ligand stands out from the surrounding protein atoms.

**solid shine style** – choose either white or color

**Stick Radius** – radius (in Angstroms) of a cylinder displayed as a part of stick or `xstick` graphical representation of a molecule. Individual (residue-wide) control of stick radii.

**Stereo Mode** – Select a default stereo mode

**Display Style** – A default display style can be chosen using a combination of styles.

**Water Radius** – radius of water sphere which is used to calculate an analytical molecular surface (referred to as skin) as well as the solvent-accessible surface (centers of water spheres).

**clashWidth** – relative width of a displayed clash.

**hbondWidth** – relative width of hydrogen bond display

**mapLineWidth** – relative width of lines and dots of a displayed map.

### 2.3.1.15.6 Image Preferences

#### **IMAGE TAB:**

Here is a summary of the important options in the IMAGE Preferences Tab.



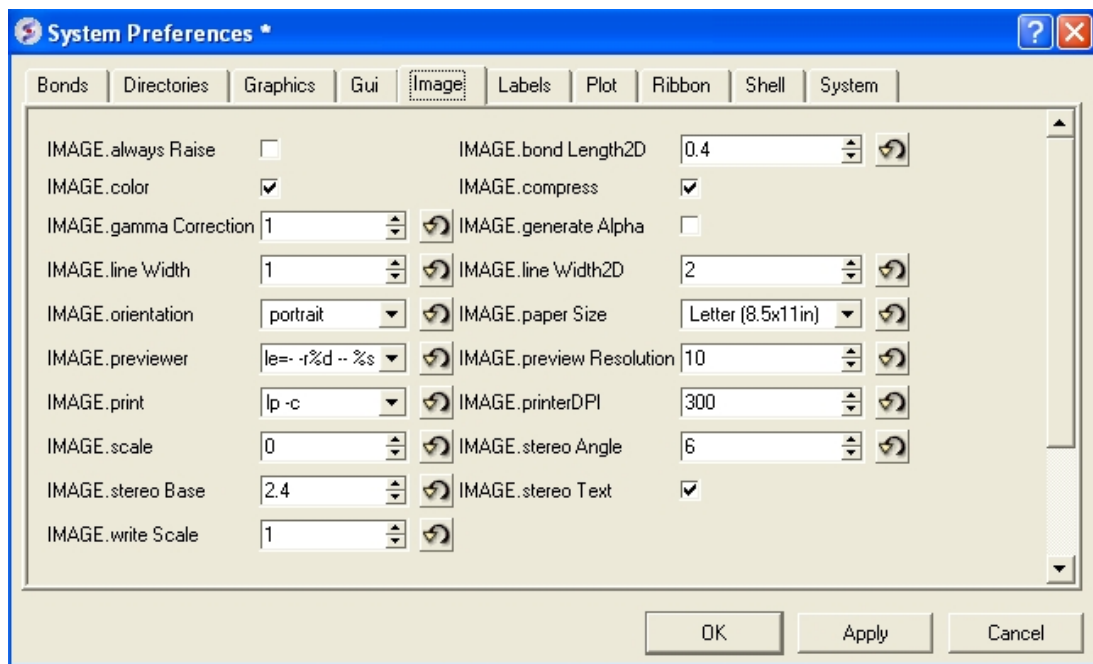

**IMAGE.color** – logical to save color or black\_and\_white ('bw') images.

**IMAGE.gammaCorrection** – real variable to to lighten or darken the image by changing the gamma parameter. A gamma value that is greater than 1.0 will lighten the printed picture, while a gamma value that is less than 1.0 will darken it.

**IMAGE.lineWidth** – this real parameter specifies the default line width for the postscript lines.

**IMAGE.orientation** – image orientation.

**IMAGE.previewer** – a string parameter to specify the external filter which creates a rough binary (pixmap) postscript preview and adds it to the header of the ICM-generated high resolution bitmap or vectorized postscript files saved by the write image postscript, and write postscript, respectively.

**IMAGE.print** – unix command for printer.

**IMAGE.scale** – real variable. If non zero, controls the image scale with respect to the screen image size.

**IMAGE.stereoBase** – real variable to define the stereo base (separation between two stereo panels) in the write image postscript and write postscript command.

**IMAGE.writeScale** – an integer parameter used to increase the image resolution in the Quick Image Write tool.

**IMAGE.bondLength2D** – real length of a chemical bond (in inches) in chemical 2D drawings upon the Copy Image command.

**IMAGE.compress** – logical to toggle simple lossless compression, standard for .tif files. This compression is required to be implemented in all TIFF-reading programs.

**IMAGE.generateAlpha** – logical to toggle generation of the alpha (opacity) channel for the SGI rgb, tif and png image files to make the pixels of the background color transparent.

**IMAGE.lineWidth2D** – integer thickness of bonds in chemical 2D drawing upon the Copy Image command. This is useful for cutting and pasting from ICM to external documents.

**IMAGE.paper Size** – specify paper size.

**IMAGE.previewResolution** – integer resolution of the rough bitmap preview added to the vectorized postscript file in lines per inch.

**IMAGE.printerDPI** – this integer parameter the printer resolution in Dot Per Inch (DPI). Important for the write image postscript command.

**IMAGE.stereoAngle** – real variable to define stereo angle (relative rotation of two stereo images) in the write image postscript and write postscript command.

**IMAGE.stereoText** – logical to make text labels for only one panel or both panels of the stereo diagram.

### 2.3.1.15.7 Font Preferences

#### LABEL FONT TAB:

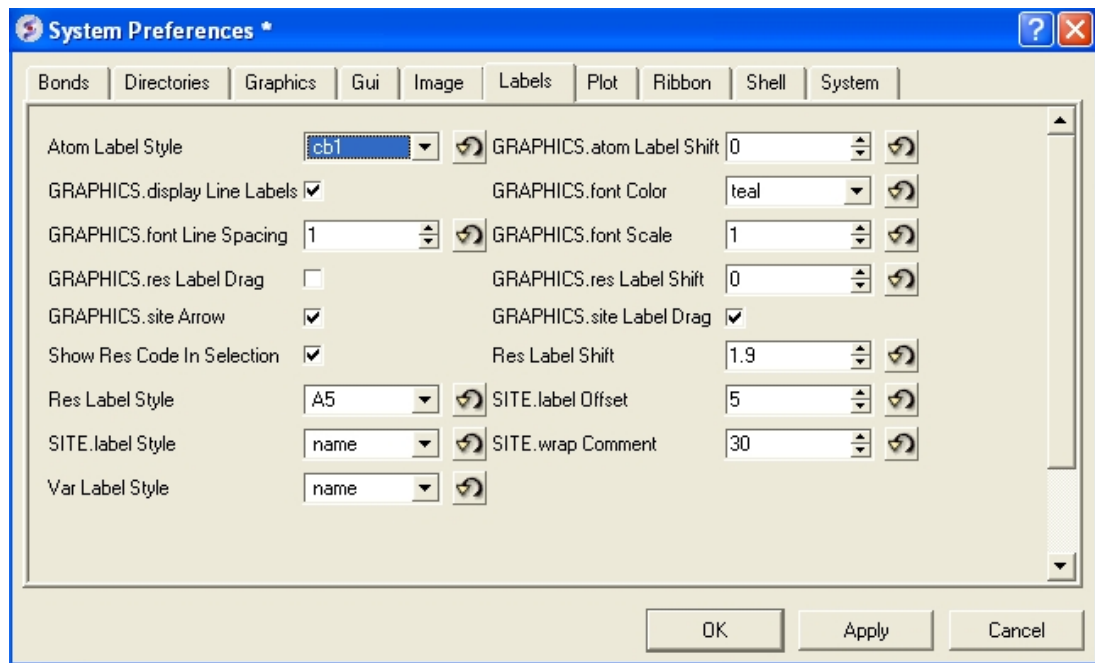

**atomLabelStyle** style of atom labels invoked by clicking on an the atom label button.

**GRAPHICS.displayLineLabels** – enables/disables the display of edge lengths (inter–point distances) of a grob generated with the Grob( "distance" .. ) function.

**GRAPHICS.font Line Spacing** – Change the spacing between lines in labels.

**GRAPHICS.resLabelDrag** – if yes, enables dragging of the displayed residue labels with the middle mouse button.

**GRAPHICS. site Arrow** – Highlight sites with an arrow yes or no.

**Show Res Code In Selection** – When you make a selection the icm selection language will be displayed when you right click on the selection.

**Res Label Style** – Default residue label style.

**SITE.label Style** – Default label sites style.

**Var Label Style** – Default label variable style.

**GRAPHICS.atomLabelShift** – a non–negative integer number of spaces preceding an atom label. This parameter is useful for displaying labels next to a solid representation,

**GRAPHICS.fontColor** – set font color

**GRAPHICS.font Scale** – set font size

**GRAPHICS.site Label Shift** – GRAPHICS.resLabelShift a non-negative integer number of spaces preceding a site label.

**GRAPHICS.site Label Drag** – if yes, enables dragging of the displayed site labels with the middle mouse button.

**Res Label Shift** – a non-negative integer number of spaces preceding a residue label. This parameter is useful for displaying residue labels next to a solid

**SITE.labelOffset** – (default 5. A) the real offset of the site label with respect to the residue label atom.

**SITE.wrap Comment** – Number of characters per comment line.

### 2.3.1.15.8 Plot Preferences

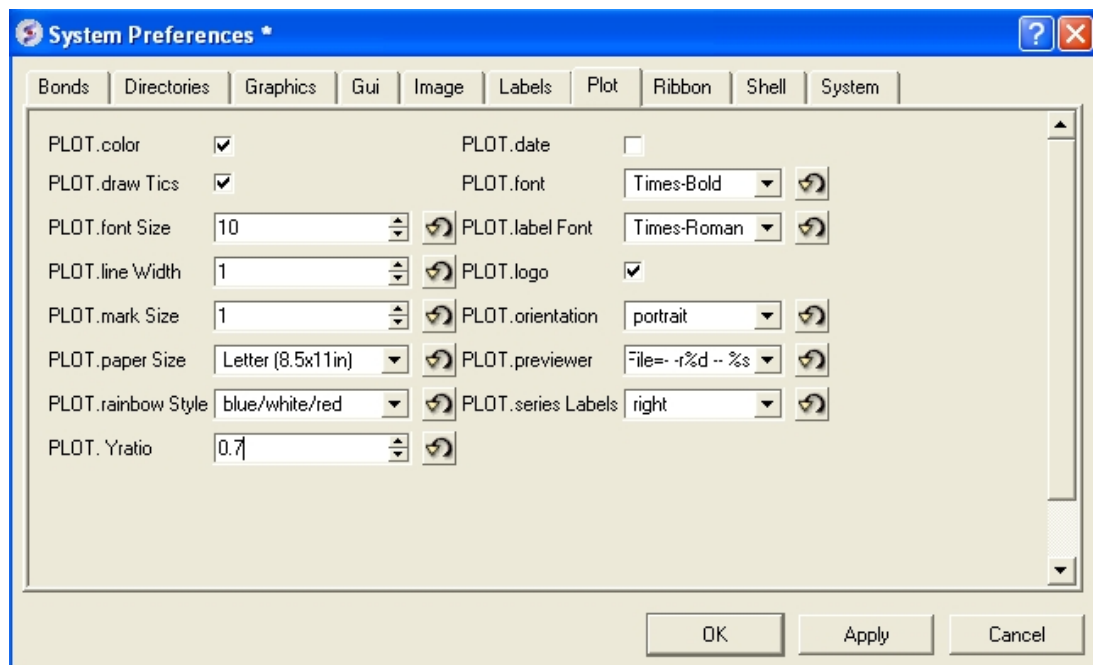

**PLOT.color** – logical to generate a color plot. Usually it does not make sense to switch it off because your b/w printer will interpret the color postscript just fine anyway.

**PLOT.draw Tics** logical yes or no

**PLOT.fontSize** real font size. Any reasonable number from 3. (1 mm, use a magnifying glass then) to 96.

**PLOT.lineWidth** – real line width for graphs (not the frame and tics)

**PLOT.markSize** – real mark size in points. Allowed mark types: line, cross, square, triangle, diamond, circle, star, dstar, bar, dot, SQUARE, TRIANGLE, DIAMOND, CIRCLE, STAR, DSTAR, BAR. Uppercase words indicate filled marks.

**PLOT.paper Size** – preference to specify plot paper size

**PLOT.rainbowStyle** – preference defining the color spectrum used by the plot area command.

**PLOT.Yratio** – real aspect ratio of the ICM plot frame. Using link option of the plot command is equivalent to setting this variable to 1.0. If PLOT.Yratio is set to 0. , the ratio will be set automatically to fill out the available box optimally.

**[PLOT.date}** – display date on plot

**PLOT.font** – preference for the title/legend font.

**PLOT.labelFont** – preference for the data point label font.

**PLOT.logo** – logical switch for the ICM–logo on the plot.

**PLOT.orientation** – preference for the plot orientation.

**PLOT.previewer** – command to local ps viewer

**PLOT.seriesLabels** – preference to indicate position of a series/color legend inside the plot frame.

### 2.3.1.15.9 Ribbon Preferences

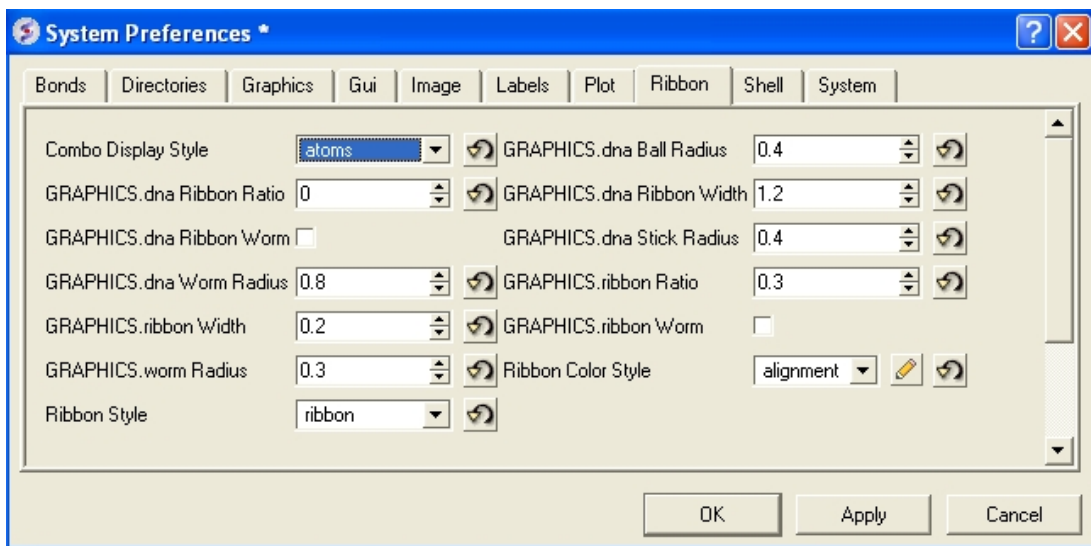

**Combo Display Style** – select ribbon–cpk, atoms, ribbon–ligand, chemical

**GRAPHICS.dnaRibbonRatio** – real ratio of depth to width for the DNA ribbon .

**GRAPHICS.dnaRibbonWorm** – logical which, if yes, makes the DNA backbone ribbon round, rather than rectangular. Default: no

**GRAPHICS.dnaWormRadius** – real radius of the worm representing bases in DNA ribbon .

**GRAPHICS.ribbonWidth** – real width of the protein ribbon .

**GRAPHICS.wormRadius** – radius of coiled segments (i.e. those where the secondary structure is marked as "\_") of a polypeptide chain in ribbon representation. Default (0.3).

**Ribbon Style** – specifies default style when ribbon is displayed.

**GRAPHICS.dnaBallRadius** – DNA bases in ribbon representation are shown as balls controlled by this real parameter.

**GRAPHICS.dnaRibbonWidth** – real width (in Angstroms) of the DNA ribbon .

**GRAPHICS.dnaStickRadius** – real radius of the sticks representing bases in DNA ribbon .

**GRAPHICS.ribbonRatio** – real ratio of depth to width for the protein ribbon .

**GRAPHICS.ribbonWorm** – logical parameter, if yes, makes the ribbon round, rather than rectangular.

**ribbonColorStyle** –

– sets the ribbon coloring scheme.

1 = "type" default. colors by secondary structure type or explicit color

2 = "NtoC" colors each chain gradually blue-to-red from N- to C- (or from 5' to 3' for DN

3 = "alignment" if there is an alignment linked to a protein, color gapped backbone regions gr

4 = "reliability" 3D gaussian averaging with selectSphereRadius of alignment strength in

If ribbonColorStyle equals to 4, the conserved areas will be colored blue, while the most dive

### 2.3.1.15.10 Shell Preferences

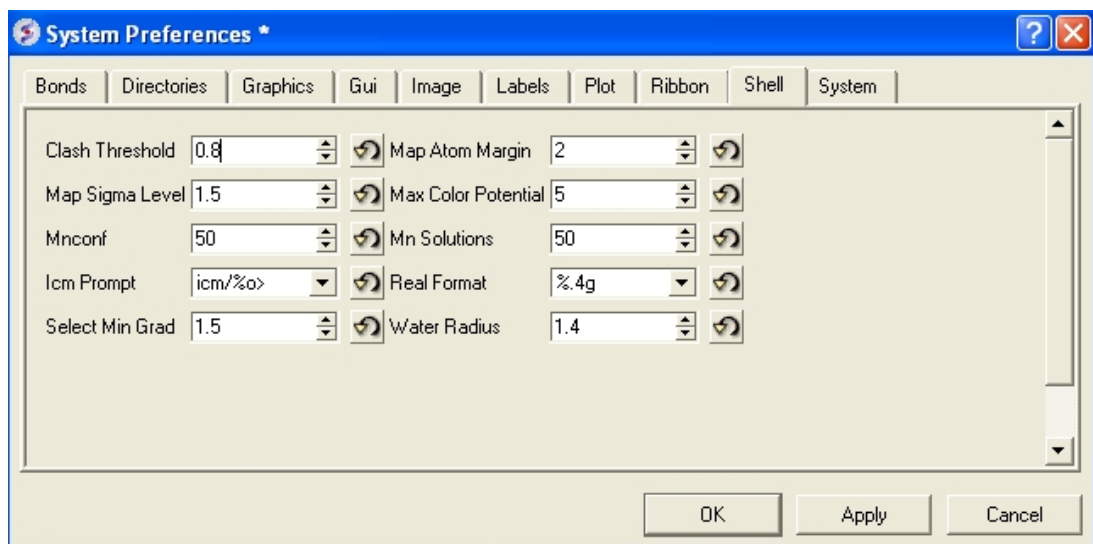

**Clash Threshold** – a clash is defined as an interatomic distance less than a sum of van der Waals radii of two atoms of interest multiplied by the clashThreshold parameter.

**Map Sigma Level** – (in Rmsd values over the mean value). Margin value used for making graphical objects contouring the 3D density map .

**Mnconf** – maximal number of conformations in the conformational stack . The stack stops growing after this number is achieved and starts replacing representative conformations with higher energy values by new conformations with superior energies, if the latter are found.

**Icm Prompt** – defines the ICM–prompt string.

**Select Min Grad** – default minimal gradient vector length for gradient atom selection ( a\_//G). This parameter is also used by the montecarlo fast command, which requires a value of 2. to 10. for optimal performance.

**Map Atom Margin** – Margin in Angstroms around selected atoms. The margin is added to the positional boundaries to define a submap index box in the Map ( map\_source , as\_ ) function.

**maxColorPotential** – local electrostatic potential in kcal/e.u.charge units at which the surface element is colored by extreme red or extreme blue. All higher values will have the same color. This absolute scaling is convenient to develop a feeling of electrostatic properties of molecular surfaces.

**mnSolutions** – this parameter limits the number of hits retained by the program after a search.

**Real Format** – format of real numbers

**Water Radius** – radius of water sphere which is used to calculate an analytical molecular surface

```
system-preferences{FTP.createFile, FTP.proxy, GUI.max Nof Recent Files, GUI.splash Screen Image,
HTTP.support Cookies, HTTP.user Agent, Beep, Max File Size Mb, USER.friends, USER.organization,
FTP.keep File, GUL.enumeration Memory Limit, GUI.splash Screen Delay, HTTP.proxy, Http Read
Style, Force Auto Bond Typing, USER.email, USER.full Name, USER.phone} h4— System Preferences
{System Preferences}
```

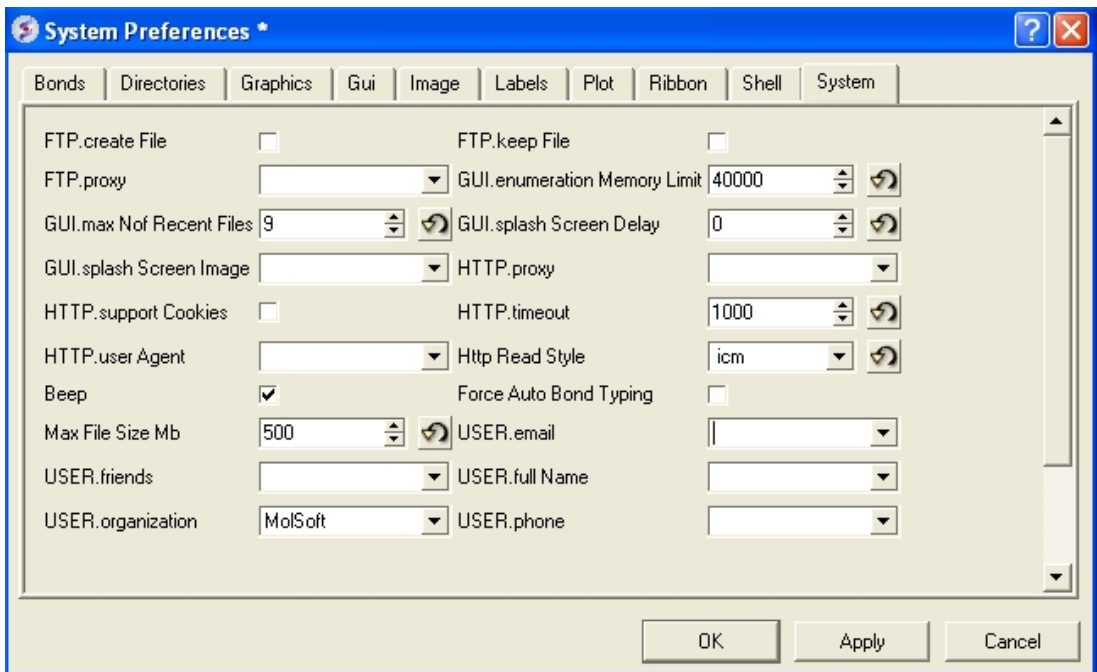

***FTP.createFile*** –

***FTP.proxy*** – string path to the proxy server for connections through firewall. Default: "" (empty string).

***GUI.max Nof Recent Files*** – maximum number of recent files stored.

***GUI.splash Screen Image*** – path to splash image displayed on startup

***HTTP.support Cookies*** – http support cookies yes or no

***HTTP.user Agent*** – client application used within a particular network protocol for www

***Beep*** – warning beep yes or no

***Max File Size Mb*** – Maximu file size in MegaBytes that can be loaded into ICM.

***USER.friends***

***USER.organization***

***FTP.keep File*** – (default no ). If yes, the temporary file is kept in the s\_tempDir directory. Otherwise the file is deleted.

***GUI.enumeration Memory Limit*** – memory limit for enumeration operations.

***GUI.splash Screen Delay***

***HTTP.proxy*** – string for HTTP server for connection through firewall

***HTTP.timeout*** – timeout in seconds

***Http Read Style*** icm or lynx

***Force Auto Bond Typing*** – yes/no

***USER.email, USER.full Name, USER.phone***

### 2.3.1.16 Recent Files

Recently viewed projects and files can be easily downloaded from the "Recent Files" option. To access this:

- Select File/Recent Files.
- Select the desired project by clicking on it once.

### 2.3.1.17 Recent PDB Codes

Quickly retrieve and display PDB structures that have recently been viewed.

- Select File/Recent PDB Codes
- Select desired PDB code by clicking on it once and it will be loaded into the graphical display.

### 2.3.1.18 Quit

Need to close down ICM – no problem. You do one of the following:

1. Select **File/Quit**. ICM will quit without saving files.
2. Save and Click **X** at the upper right corner of the ICM window.
3. Type `quit` in the terminal window.

**NOTE:** You may want to save the icm session as an ICM Project file before quitting.

## 2.3.2 Edit Menu

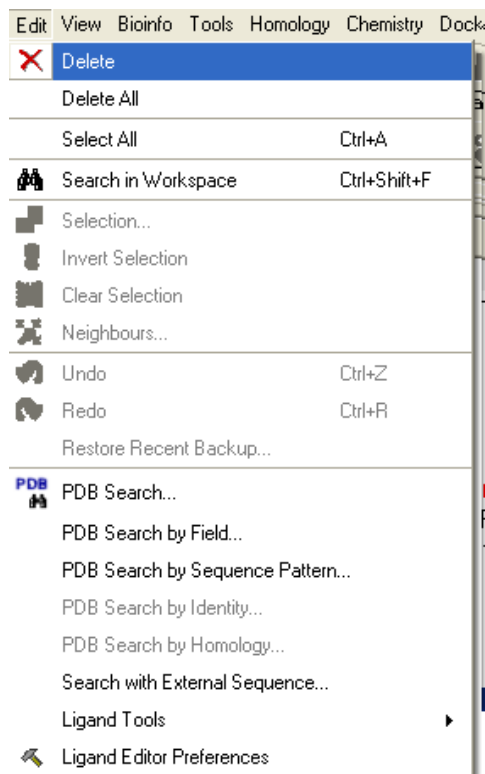

### 2.3.2.1 Delete

This option will delete anything that is selected.

### **2.3.2.2 Delete All**

This option will delete everything e.g. sequences, structures, tables ... Use with care!

### **2.3.2.3 Select All**

This option will select everything e.g. sequences, structures, tables...

### **2.3.2.4 Search in Workspace**

This option allow you to search for a particular text in the workspace

### **2.3.2.5 Selection**

This option allows you to make a precise selection either by neighbors or specifying a particular atom or neighbor. Click on the tabs to jump between selection levels.

### **2.3.2.6 Invert Selection**

This option will select everything that is not currently selected.

### **2.3.2.7 Clear Selection**

This option will remove all selections. For more information on selections see the [Making Selections Chapter](#).

### **2.3.2.8 Neighbor Selection**

This option will allow you to select neighboring atoms. For more information see the [Select Neighbors](#) section in the [Selections Chapter](#).

### **2.3.2.9 Undo**

Due to the complexities of working in an internal coordinates environment not everything can be undone or redone. Certain things like coloring and representations can be undone or redone.

### **2.3.2.10 Redo**

Due to the complexities of working in an internal coordinates environment not everything can be undone or redone. Certain things like coloring and representations can be undone or redone.

### **2.3.2.11 Restore Recent Backup**

ICM periodically makes a backup of your ICM project. If for whatever reason you lose an ICM session and you want to load the backup for the file use:

#### **Edit/Restore Recent Backup**

### **2.3.2.12 PDB Search**

See [PDB Search Tab](#)

### **2.3.2.13 PDB Search by Field**

See [PDB Search Tab](#)



### 2.3.2.14 PDB Search by Identity

See PDB Search Tab

### 2.3.2.15 PDB Search by Homology

See PDB Search Tab

### 2.3.2.16 PDB Search with External Sequence

See PDB Search Tab

### 2.3.2.17 Ligand Tools

See the ligand editor section of the manual.

### 2.3.2.18 Ligand Editor Preferences

See the ligand editor section of the manual.

## 2.3.3 View Menu

### View Menu

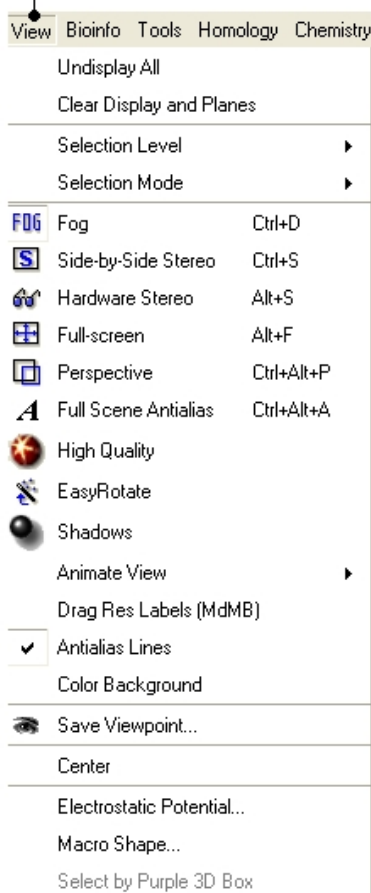

### View Buttons

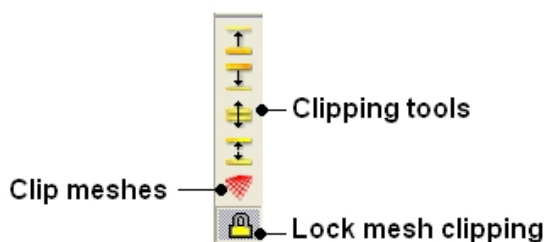
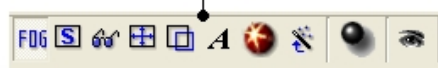

### 2.3.3.1 Undisplay All

*To undisplay everything currently displayed in the graphical display*

- View/Undisplay All

**Note** For more details on displaying structures please see the GUI Overview chapter.

### 2.3.3.2 Clear Display Planes

*To clear the display and planes*

- View/Clear Display and Planes

**NOTE:** For more details on planes please see the sections on clipping tools and mesh clipping.

### 2.3.3.3 Selection Level

There are four levels of selection – atom, residue, molecule and object. For more details on selections please see the Making Selections section.

### 2.3.3.4 Selection Mode

There are four different ways to make selections – new, add, remove and toggle. For more details on selections please see the Making Selections section.

### 2.3.3.5 Fog

**Fog Toggle**(Ctrl + D) : this feature creates a fog-like environment for your object, so that the part of your structure that is closer appears clear and the distant parts are faded as if they are in fog. The clipping planes control the point at which the fog begins.

- View/Fog

### 2.3.3.6 Side-by-Side Stereo

**Side-by-side stereo toggle**(Ctrl + S) : this feature allows you to view your structure in 3D form without any 3D goggles.

- View/Side-by-Side Stereo

### 2.3.3.7 Hardware Stereo

**Hardware stereo toggle**(Alt + S) – if you have 3D goggles and you wish to view your structure in 3D form, this feature will allow you to do so.

- View/Hardware Stereo

### 2.3.3.8 Full Screen

**Full screen toggle**Alt\_F – this makes your graphical display fill the entire screen. If you wish to exit this mode, press escape.

- View/Full Screen

### 2.3.3.9 Perspective

**Toggle perspective Ctrl\_P** this will add perspective to your structure, enhancing depth in the graphical display.

- View/Perspective

### 2.3.3.10 Full Scene Antialias

Anti-aliasing is the technique of minimizing the distortion artifacts known as aliasing when representing a high-resolution signal at a lower resolution. Always use this option before making high resolution images.

- View/Full Scene Antialias

### 2.3.3.11 High Quality

**Toggle High Quality:** this option will give your ICM object better resolution and higher quality. The change in quality is most visible at a high magnification. However, if your object is very large, this feature could slow down your program.

Always use this option before making high resolution images.

- View/High Quality

### 2.3.3.12 Easy Rotate

**Toggle easy rotation:** this feature is necessary if your structure is very large or perhaps your computer cannot quickly rotate it. It will prevent your structure from fully loading each time you rotate it, therefore speeding up the process.

- View/Easy Rotate

### 2.3.3.13 Shadows

- View/Shadows

OR

select the shadow button shown below.

Toggle shadow

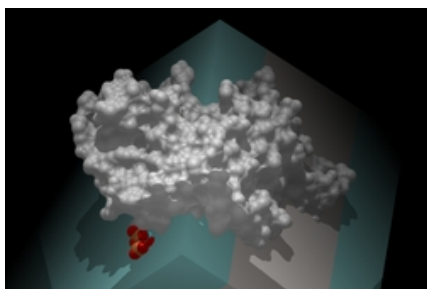

### 2.3.3.14 Sketch Accents

*To make images as shown below use:*

- View/Sketch Accents

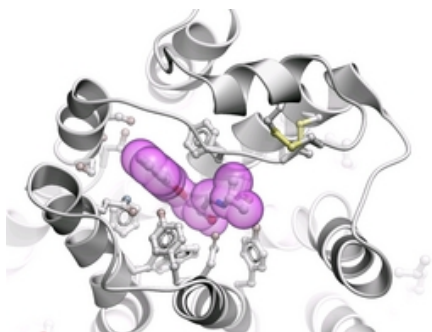

### 2.3.3.15 Animate View

This tool is described in more detail in the [Molecular Animations and Transitions](#) section.

### 2.3.3.16 Drag Res Labels

*To change the location of your residue label:*

- Select View/Drag res labels.
- If your mouse has a middle mouse button, then click on handle (as shown) of the label you wish to move, and drag it to your desired area.

Click on  
this area  
to drag  
your  
label.



- If your mouse has no middle mouse button, then click on the Translation icon on the toolbar, and click on the handle (as shown) of the label you wish to move, and drag it to your desired area.

The +/- buttons on the side of the Residue and Atom buttons will shift the label. There are also other **residue label move** options available when you click and hold the residue label button. These options include **Shift to Sidechain Tips**, **Shift to Calphas**, and **Restore Positions**

### 2.3.3.17 Antialias Lines

Use this option to activate antialias lines. It is recommended to leave this option selected.

- View/Antialias Lines

### 2.3.3.18 Color Background

*To change the background color*

- View/Color Background
- Select a color from the panel and press OK.

This option is also in the more convenient `display` tab.

### 2.3.3.19 Save Viewpoint

It is possible to store a current view using the button shown below.



Store Current View

Click on the button and the current view will be stored so that you can view it later. A data entry box will be displayed asking you to name the view. All stored views can be found in the ICM workspace as shown below.



- Double click on the view in the ICM Workspace to display it.

A number of view display options are available by right clicking on the view in the ICM workspace as shown below.

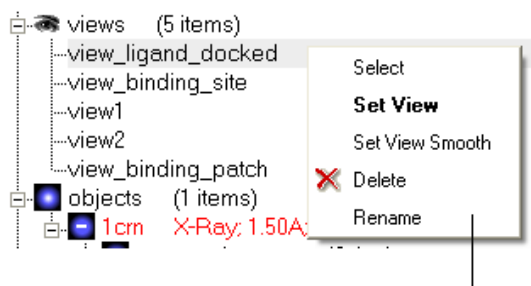

Store current view right click menu

The option in the right click menu called "set view smooth" returns to the view slowly showing the trajectory between the original view and the current one.

### 2.3.3.20 Center

*To center on an object displayed in the graphical display*

- Make a selection on the region on which you wish to center on.
- Tools/Center (or use the center button on the right hand-side of the graphical display).

### 2.3.3.21 Electrostatic potential

This option generates the skin representation of the molecular surface colored according to the electrostatic potential calculated by the REBEL method (hydrogen atoms are ignored). REBEL is a method to solve the Poisson equation for a molecule. REBEL is a powerful implementation of the boundary element method with analytical molecular surface as dielectric boundary. This method is fast (takes seconds for a protein) and accurate. REBEL stands for Rapid Exact-Boundary ELectrostatics. The energy calculated by this method consists of the Coulomb energy and the solvation energy

*In order to color the skin of your molecule by electrostatic potential:*

- Select **View/Electrostatic** potential.
- Enter the potential scale value. This is the local electrostatic potential in kcal/e.u.charge units at which the surface element is colored by extreme red or extreme blue. All higher values will have

the same color. This absolute scaling is convenient to develop a feeling of electrostatic properties of molecular surfaces.

- Areas colored blue represent positive areas and red represents negative areas.

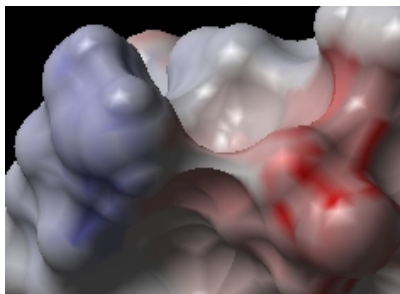

### 2.3.3.22 Macro Shape

A macroshape allows easy viewing and manipulation of a structure. A macroshape representation is ideal for large structures which allows the user to easily identify important regions of the structure and facilitate the return to the 'standard' view of a particular molecule. The level of detail displayed in the macroshape can be controlled by changing the number of harmonics, gridStep, and, contour level.

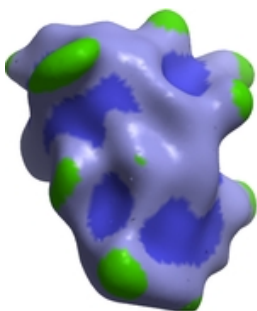

- View/Macro Shape

### 2.3.3.23 Select by Purple 3D Box

An alternative way to make a make-selection{selection} is to use the purple 3D box. To do this:

- Select the **display** tab and the purple box button
- View/ Select by Purple 3D Box
- The atoms contained within the purple box will be selected.

## 2.3.4 Bioinfo Menu

The tools in the Bioinfo Menu are described here

## 2.3.5 Tools Menu – Xray

**Note:** Click **Next** (top right hand corner) to navigate through this chapter. Headings are listed on the left hand side (web version) or by clicking the **Contents** button on the left-hand-side of the help window in the graphical user interface.

## Tools Menu / Xray

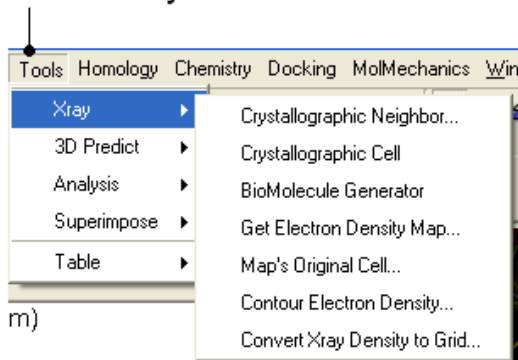

### 2.3.5.1 Crystallographic Neighbor

See Crystallographic Neighbor

### 2.3.5.2 Crystallographic Cell

See Crystallographic Cell

### 2.3.5.3 Biomolecule Generator

See Biomolecule

### 2.3.5.4 Get Electron Density Map

See Load Electron Density Map

### 2.3.5.5 Map's Original Cell

See Load Map's Original Cell

### 2.3.5.6 Contour Electron Density Map

See Contour Electron Density Map

### 2.3.5.7 Convert Xray Density to Grid

See Convert Xray Density to Grid

## 2.3.6 Tools Menu – 3D Predict

## Tools / 3D Predict

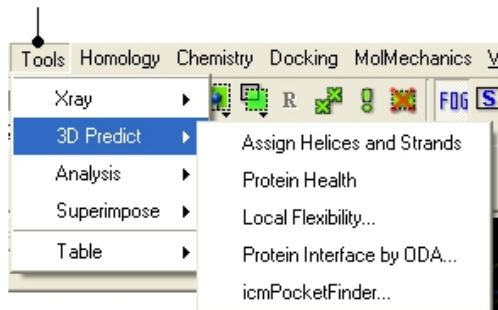

### 2.3.6.1 Assign Helices and Strands

See Assign Helices and Strands

### 2.3.6.2 Protein Health

See Protein Health

### 2.3.6.3 Local Flexibility

See Local Flexibility

### 2.3.6.4 Protein Interface by ODA

See Predict Protein-Protein Interfaces

### 2.3.6.5 icmPocketFinder

See Identify Ligand Binding Pockets

## 2.3.7 Tools Menu – Analysis

**Note:** Click **Next** (top right hand corner) to navigate through this chapter. Headings are listed on the left hand side (web version) or by clicking the **Contents** button on the left-hand-side of the help window in the graphical user interface.



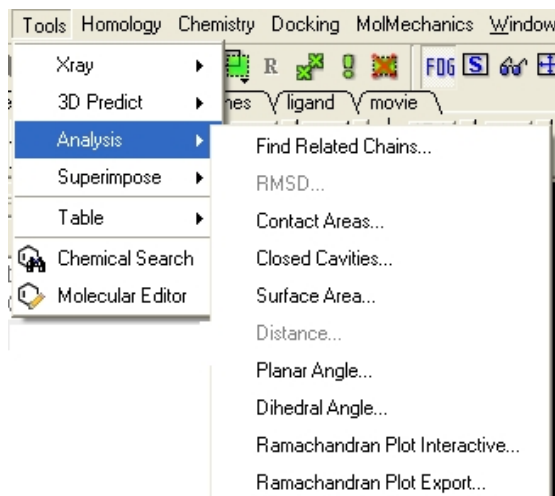

### 2.3.7.1 Find Related Chains

See Find Related Chains

### 2.3.7.2 RMSD

See Calculate RMSD

### 2.3.7.3 Contact Areas

See Calculate Contact Areas

### 2.3.7.4 Closed Cavities

See Closed Cavities

### 2.3.7.5 Surface Area

See Surface Area

### 2.3.7.6 Distance

See Measure Distances

### 2.3.7.7 Planar Angle

See Measure Planar Angle

### 2.3.7.8 Dihedral Angle

See Measure Dihedral Angle

h4 — Ramachandran Plot Interactive {Ramachandran Plot} \_\_REQUIRES(P)

See Ramachandran Plot

### 2.3.7.9 Export Ramachandran Plot

See Ramachandran Plot Export

## 2.3.8 Tools Menu – Superimpose

### Tools / Superimpose

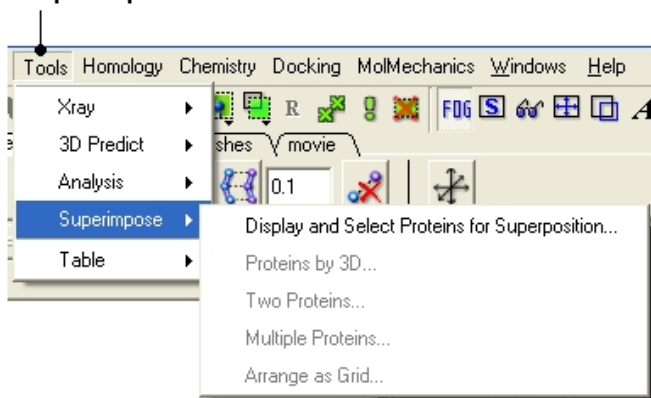

#### 2.3.8.1 Display and Select Proteins for Superposition

See Protein Superposition

#### 2.3.8.2 Proteins by 3D

See Superimpose Proteins by 3D

#### 2.3.8.3 Multiple Proteins

See Superimpose Proteins by 3D

#### 2.3.8.4 Arrange as Grid

See Superimpose Proteins by 3D

## 2.3.9 Tools Menu – Extras

### 2.3.9.1 Plot Function

*To plot a function:*

- Tools/Extras/Plot Function
- Enter the Function(x) eg Sin(x)
- Enter the starting value of x (From).
- Enter the end point of x (To).
- Enter the number of points (N points).
- Click OK and your plot will be displayed next to a table of values for your function.

## 2.3.10 Tools Menu – Table

### 2.3.10.1 Build Prediction Model

Learn and Predict tools are described here.

### 2.3.10.2 Predict

Learn and Predict tools are described here.

### 2.3.10.3 Cluster Set

This is described in the cluster section of the Working with Tables Chapter.

### 2.3.10.4 Sort Table

There are a couple of ways to sort a chemical table. You can right click on the a column header and select sort or you can use the option in the menu Chemistry/Sort Table.

- Read a chemical table into ICM.
- Select the columns by which you wish to sort by as shown below.
- Select **Ascending** or **Descending** and for each **sort by** option and then click OK

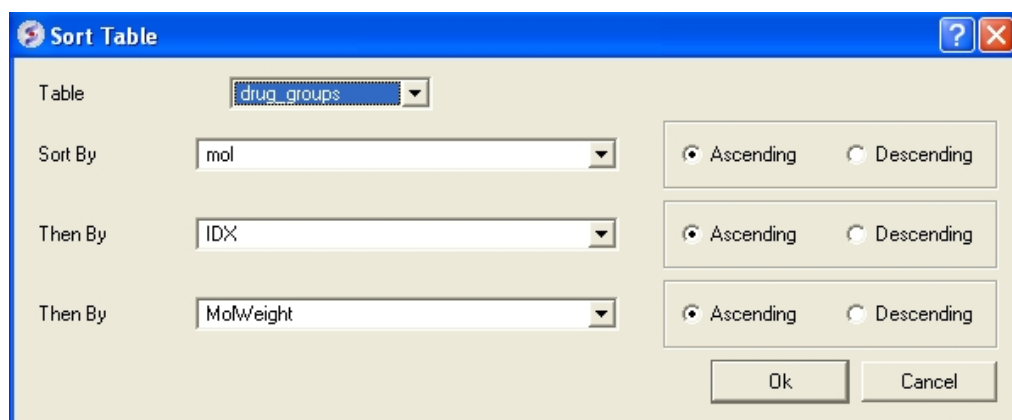

### 2.3.10.5 Merge Two Sets

*To merge two tables:*

- Read the two tables into ICM.
- Tools/Table/Merge Two Sets
- Select the first table from the drop down list (Table A) and the column you wish to use to merge the table by.
- Select merge method 1. **inner** – only molecules present in BOTH A and B tables are kept; or 2. **left** ALL rows of A are kept ; or 3. **right** ALL rows of B are kept.
- Select the second table from the drop down list (Table B) and the column you wish to use to merge the table by.
- Enter a name for the output table.
- Click OK and a new table will be displayed.

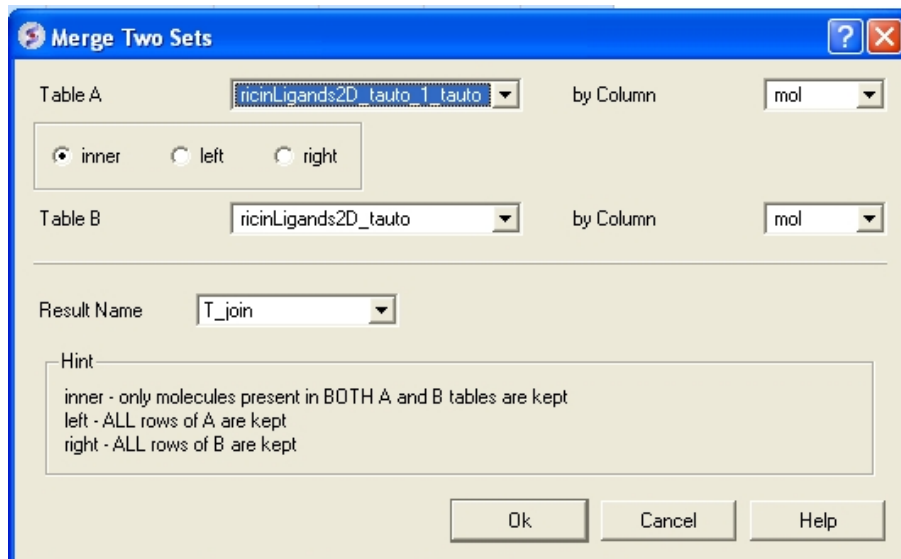

### 2.3.10.6 Add External Columns

*To add external columns to a table:*

- Read at least two tables into ICM – the table you want to add to and the table you want to add the column from.
- Tools/Table/Add External Columns
- Enter the target table name and the column you wish to match each table by.
- Enter the source of the new column (Other table and column name)
- Choose to add "all the columns" from the source or "overwrite matching columns" or select the columns you want to add by selecting the "choose column" option.

### 2.3.10.7 Append Rows

*To append rows from one table to another one:*

- Read at least two tables into ICM – the table you want to add to and the table you want to add the column from.
- Tools/Table/Append Rows
- Enter the name of the Target Table (where you will append).
- Enter the name of the Source Table (where you will append from).

## 2.3.11 Tools Menu – Chemical Search

Chemical searching is described in the Chemistry chapter here.

## 2.3.12 Tools Menu – Molecular Editor

The molecular editor is described in the Chemistry chapter here.

## 2.3.13 Homology Menu

The options in this menu are described in the Homology Modeling Chapter.

## 2.3.14 Chemistry Menu

The tools in the **Chemistry** menu are described here.

## 2.3.15 Docking Menu

The tools in the **Docking** menu are described in the Docking chapter.

## 2.3.16 MolMechanics Menu

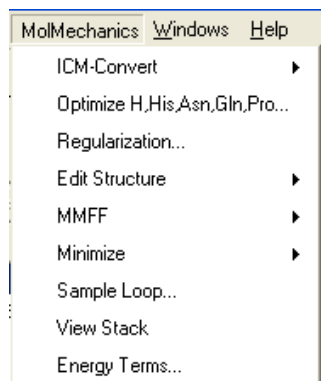

### 2.3.16.1 ICM Convert

See Molecular Mechanics Chapter.

### 2.3.16.2 Optimize H,His,Asn,Gln,Pro

See Molecular Mechanics Chapter.

### 2.3.16.3 Regularization

See Molecular Mechanics Chapter.

### 2.3.16.4 Impose Conformation

See Molecular Mechanics Chapter.

### 2.3.16.5 Edit Structure

See Molecular Mechanics Chapter.

### 2.3.16.6 MMFF

See Molecular Mechanics Chapter.

### 2.3.16.7 Minimize

See Molecular Mechanics Chapter.

### 2.3.16.8 Sample Loop

This option is described in the Loop Modeling section.

### 2.3.16.9 Generate Normal Mode Stack

See Molecular Mechanics Chapter.

### 2.3.16.10 Stack

See Molecular Mechanics Chapter.

### 2.3.16.11 GAMESS

See Molecular Mechanics Chapter.

### 2.3.16.12 Energy Terms

See Molecular Mechanics Chapter.

## 2.3.17 Windows Menu

This menu allows you to choose the windows you wish to display. The windows which open automatically when you first open GUI are shown in the Default GUI section. Other windows can be displayed by selecting the windows menu. For example, if you have loaded a table but cannot see it in the GUI it may be because the Tables option in the window menu hasnt been selected.

To add or remove windows from the GUI display select the 'window menu'. Other windows not included in the default display such as tables and alignments can be added.

**I have windows open everywhere - Please bring some order.**

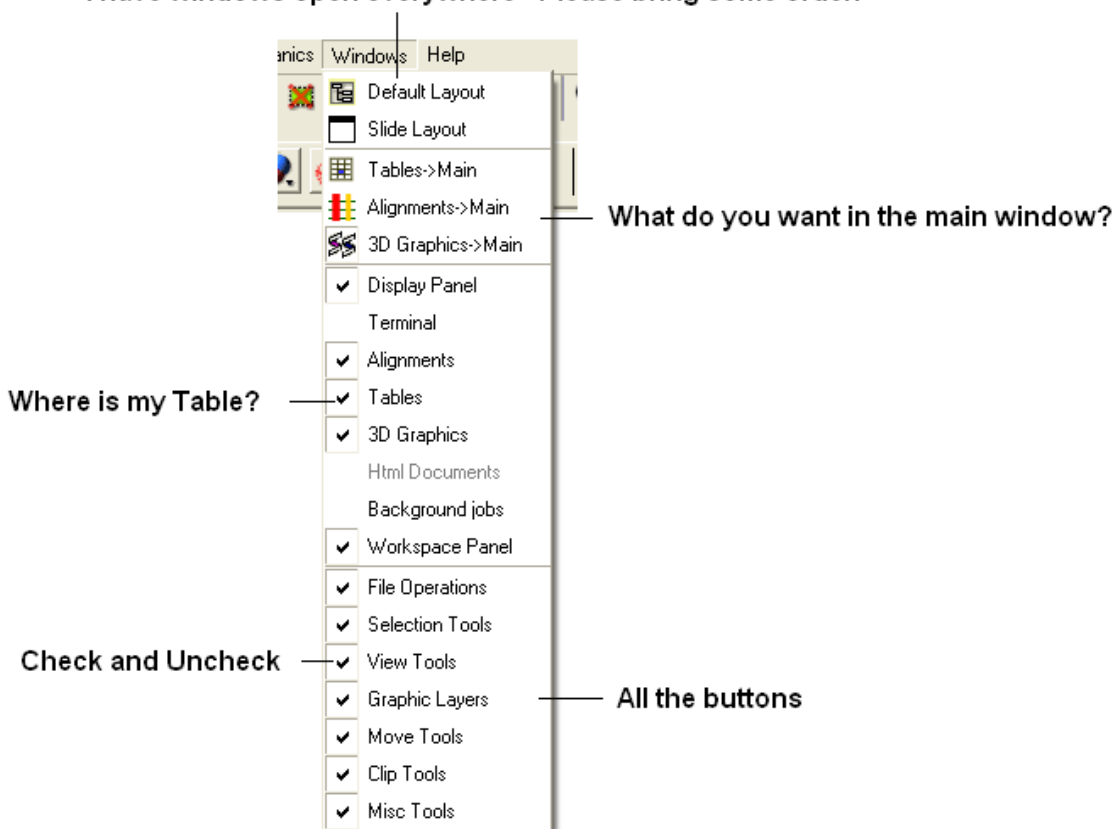

To return to the default display option select the 'Default layout' option in the windows menu.

OR

Click the default layout icon.

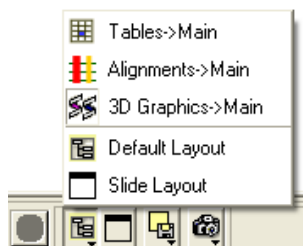

Some options can be accessed at the bottom of the GUI.

## 2.4 Tab Guide

In this section we describe the contents of the tabs in the graphical user interface.

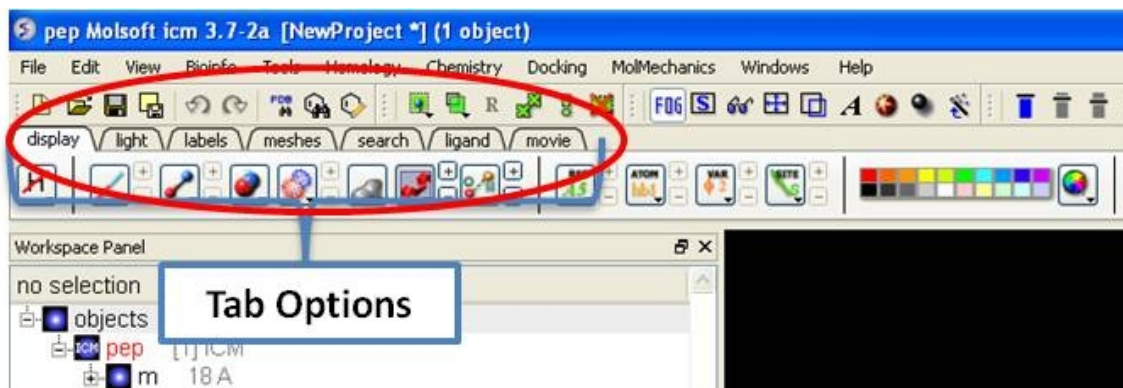

### 2.4.1 Display Tab

The display tab contains tools for a variety of functions including – structural representations, coloring, labeling and superposition. This tab is shown below.



### 2.4.2 Light Tab

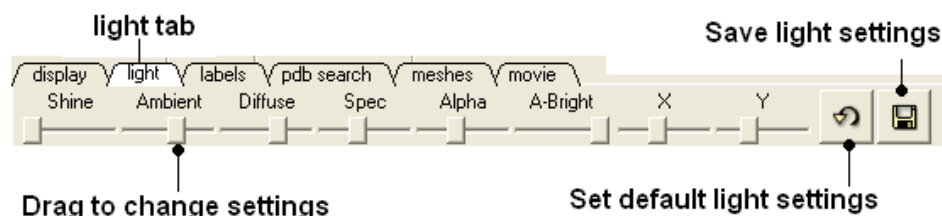

The options in this tab are described in the Lighting Section.

### 2.4.3 Labels Tab

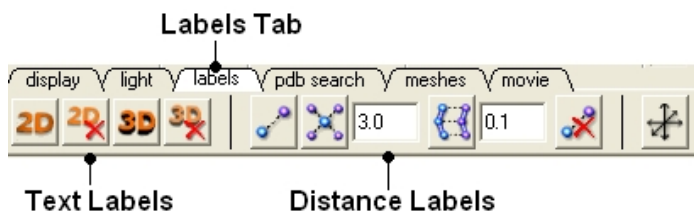

The options in this tab are described in the `labels` section of this manual.

## 2.4.4 PDB Search Tab

Instructions on how to use this tab can be found in the `Search PDB` section.

## 2.4.5 Meshes Tab

Click on the tab button entitled '**meshes**' and three different graphical display tools are available for you to use. The three displays are surface, meshes and macroshape and are collectively referred to as meshes.



The benefits and applications of each display are described in the `section`.

## 2.4.6 Movie Tab

The options in this tab are described in the `View Defined Movie Making` section of the `Movie Making` Chapter.







## 3 Working with Protein Structures

**Note:** Click **Next** (top right hand corner) to navigate through this chapter. Headings are listed on the left hand side (web version) or by clicking the **Contents** button on the left-hand-side of the help window in the graphical user interface.



In this chapter we describe how to work with protein structures. We describe how to read them into ICM and display key features of the structure such as the ligand binding pocket and hydrogen bonds. We also teach how to convert a PDB file into an ICM object which is a critical operation if you want to perform any energy related task such as docking, displaying h-bonds etc...

### 3.1 Searching the PDB

The **PDB search tab** provides easy access to the PDB database. You can use keyword searching or type in the PDB code you are interested in. An asterisk (\*) wildcard can be used to list all the pdb files currently available in the protein databank. Different fields can be searched by using the drop down arrow as shown below. More advanced PDB search tools and how to use the PDB search result table are described in the section entitled Searching the PDB.

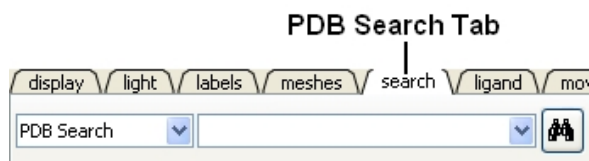

Once a search is complete a table of PDB files relating to your search query will be displayed. To view the PDB file in 3D in the graphical display double click on a row in the `PDBSearchResults` table.

**NOTE:** If you have a PDB structure already saved you can read it into ICM by going to the File Menu and selecting Open. PDB files that have been viewed previously can be loaded using File/ Recent PDB Codes.

#### 3.1.1 Searching the PDB

Protein structures solved by X-ray crystallography, NMR or other experimental methods are stored in the Protein Data Bank (PDB). These structures can be easily accessed, displayed and analyzed using ICM.

There are a number of different ways to find a structure from the PDB database and load it into ICM: You can query the PDB using the following options:

##### 3.1.1.1 Query PDB by Keyword or PDB Code

###### Query by Keyword of PDB Code

- Click on the PDB search tab.
- Enter the PDB code or search string.
- Click on the search button to run the search.
- A list of related PDB entries based on your search will be displayed in the `PDBSearchResults` table of the graphical user interface.

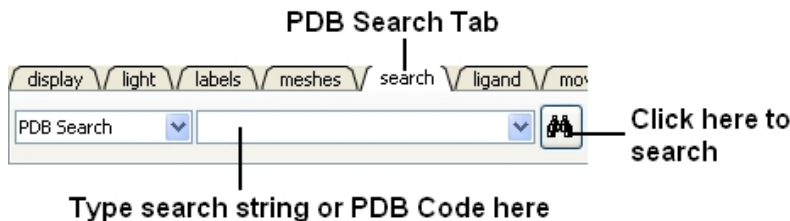

Or

- Select **Edit/PDB** search and the "Find PDB Entries by Keyword" data entry window will be displayed.
- Enter a keyword or PDB code into the Keywords data entry field.
- Click the **OK** button and a list of related PDB entries based on your search will be displayed in the `PDBSearchResults` table of the graphical user interface.

**NOTE:** If a keyword has been entered previously it will be available by clicking on the drop-down button.

### 3.1.1.2 Query PDB by Sequence

*To query the PDB by sequence:*

- Click on the PDB search tab.
- Select the drop down arrow and select one of the following options

**Seq Pattern**– Enter a protein sequence and this option will tell you whether a protein structure exists in the PDB for that sequence.

**Close Match**– Enter a protein sequence and this option will tell you which sequences are similar to your entered sequence.

**Homology**– Enter a protein sequence and homologous proteins in the PDB will be displayed in a table.

- Click the **Search** button and a list of related PDB entries based on your search will be displayed in the `PDBSearchResults` table of the graphical user interface.

### 3.1.1.3 Query PDB by Ligand Code

*To query the PDB by ligand code:*

- Click on the PDB search tab.
- Select the drop down arrow and select ligand code option from the list.
- Enter the ligand code and press the search button.
- Click the **Search** button and a list of related PDB entries based on your search will be displayed in the `PDBSearchResults` table of the graphical user interface.

### 3.1.1.4 Query PDB by PDB Field

**To query the PDB by field (Author, Compound, PDB Header, Experiment Type, Resolution or Ligand Code**

- Select **Edit/PDB** search by field.
- Enter the search string or value
- Click **OK** and a list of related PDB entries based on your search will be displayed in the `PDBSearchResults` table of the graphical user interface.

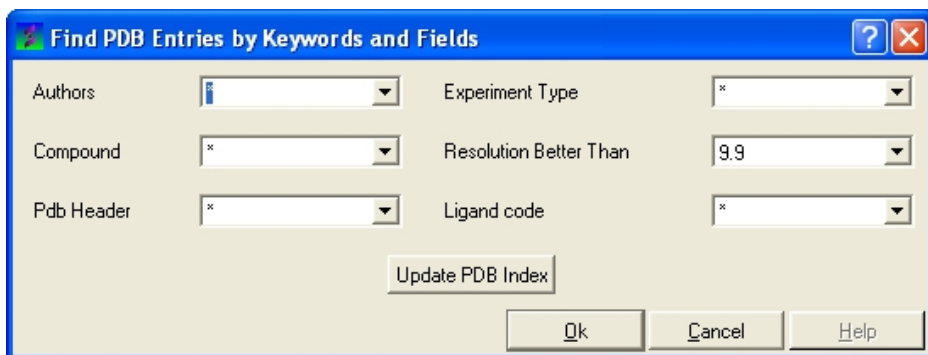

### 3.1.2 Sensitive PDB Similarity Searches

There are two ways to search a sequence against the PDB database.

#### OPTION 1:

If your sequence is already loaded into ICM:

- Select **Edit/PDB Search by sensitive similarity**
- Type the sequence name into the **Sequence name** field. Sequences which are already loaded into ICM can be seen by clicking the drop-down button
- Select the number of hits you wish to see by typing the number into the Limit field. A number can also be selected by clicking on the up and down arrows. (Default is 50)
- Select the sensitivity of your search by typing a value into the Expect field. This value is a database-size error estimate and the default value is 0.01.
- Choose whether you wish to display All entries or Entries with unique sequence by checking the appropriate button.
- If you wish to load the sequences leave the Load Sequences box checked.
- If you merely want to see the PDB codes which are similar to your sequence then un-check the Load Sequences box.
- Click the **OK** button.

#### OPTION 2:

If your PDB sequence is not loaded into ICM:

- Select **Edit/Search with external sequence**
- Cut and paste or type (shown below) your sequence into the **Sequence** data entry field.
- Select the number of hits you wish to see by typing the number into the **Limit** field. A number can also be selected by clicking on the up and down arrows. (Default is 50)
- Select the sensitivity of your search by typing a value into the **Expect** field. This value is a database-size error estimate and the default value is 0.01.
- Choose whether you wish to display **All entries** or **\*\* Entries with unique sequence \*\*** by checking the appropriate button.
- If you wish to load the sequences leave the **Load Sequences** box checked.

**NOTE:** If you merely want to see the PDB codes which are similar to your sequence then un-check the Load Sequences box.

- Click the **OK** button.

**NOTE:** You can also use the toolbar search option by homology if you wish.

### 3.1.3 PDB Search Results Table

Once you have searched for a PDB structure, a table with the search results will be displayed on the bottom of the ICM window. See the Tables section for more information on how to use ICM tables. See the next section loading your PDB file for information how to view the PDB file. More information about

working with tables can be found in the Tables Section of this manual.

- To load a pdb file double click on the search results table.
- Sort the table by right clicking on the column header. Other table manipulation options are described in the Working with Tables chapter.

Double click anywhere in the table to load the PDB file

ID	name	date	title	source	auth	exp
1	<a href="#">2kd2</a>	01/01/04	structure of hydroxyethyltransferase kinase protein from <i>Pyrococcus horikoshii</i>	PYROCOCCUS HORIKOSHII	Jayaraman, J., Takasu, T.H., REN, Shunxiang	XR
2	1ah	01/03/95	crystal structure of the tyrosine kinase domain of the human	HOMO SAPIENS	Hubbard, S.R., Wei, L., Ellis, L., Hendrickson, W.A.	XR
3	1gsh	01/03/02	crystal structure of mycobacterium tuberculosis mycolate	MYCOBACTERIUM TUBERCULOSIS	Unby, T., Weik, M., Florant, E., Delmas, M., Gohlker, M., SH	XR
4	1hcy	01/04/01	binding of nucleotides to ndp kinase	DICTYOSTELIUM DISCOIDEUM	Carroll, L., Lessou, I., Hu, Y., Goss, P., Moss, M., Marouani, M., SH	XR
5	2k9	01/04/05	human protein kinase c- $\delta$	HOMO SAPIENS	Walker, J.R., Little, D.R., Feeney, J., P.J., Macdonald, F.	XR
6	2hw2	01/04/08	morpholine pyridothiazine p38 alpha map kinase inhibitor	HOMO SAPIENS	Sack, J.S.	XR
7	2hw3	01/04/08	morpholine pyridothiazine p38 alpha map kinase inhibitor	HOMO SAPIENS	Sack, J.S.	XR
8	1agq	01/04/96	3-phosphoglycerate kinase, mutation r65g	SACCHAROMYCES CEREVISIAE	Moghil, T.M., Hsu, B.T., Sherman, M.A., Mes, M.T., Rees, J.	XR
9	1vqv	01/05/05	crystal structure of thiamine monophosphate kinase (tmk)	AQUIFERAEOLICUS	Evansmorrisby, S., Swaminathan, S., Surley, S.F., New York, XR	XR
10	1y9s	01/05/05	crystal structure of pyruvate kinase in complex with	OVIS ARIES	Tang, L., Li, M.-H., Cao, F., Wang, F., Chang, W.-R., Beck, S.	XR
11	1y9p	01/05/05	crystal structure of pyruvate kinase in complex with	OVIS ARIES	Tang, L., Li, M.-H., Cao, F., Wang, F., Chang, W.-R., Beck, S.	XR

Right click on column header for sort and other table options

**NOTE:** In the table there are blue hyperlinks directing you to the PDB and Uniprot websites.

### 3.1.4 Loading Your PDB File

- To load a pdb file double click on the search results table.
- Sort the table by right clicking on the column header. Other table manipulation options are described in the Working with Tables chapter.

### 3.1.5 Load and Display NMR Structures

Use the PDB Search tab to load NMR structures from the PDB. You can use the drop down button shown below to determine how you want to display your NMR structure. You can choose to display and download the first NMR model, all models in the PDB file or all models in the PDB in a stack.

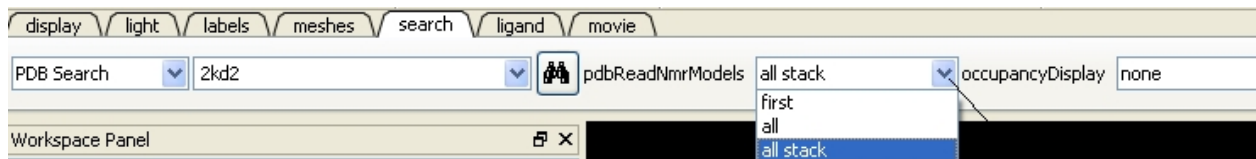

Click for drop down menu

### 3.1.6 Occupancy Display

You can use the options in the PDB Search tab to control if and how the partial or zero atom occupancies are displayed. You can choose to circle or label the poor occupancy atoms.



### 3.1.7 Hyperlinks to PDB Website and UniProt

In the PDB Search Results Table you will see blue hyperlinks that will take you directly to the PDB website or UniProt website.

### 3.1.8 Display PDB Header

To display the PDB Header for a PDB file.

- First load a PDB file into ICM (see Load PDB)
- Double click on the word header in the ICM Workspace.

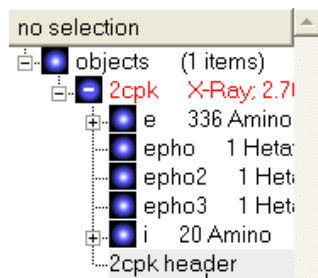

Double Click Here

- The PDB Header information will be displayed.
- Click on the blue hyperlinked text to link to external web pages for additional information if needed.

### 3.1.9 Direct link to PubMed

When you search for a PDB file and load it into ICM you will see an icon (shown below) next to your protein name in the ICM Workspace. Click the icon and you will be taken directly to the PubMed primary reference relating to the structure.

#### Direct access to PubMed

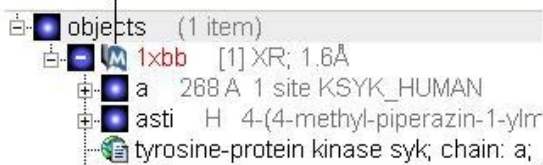

## 3.2 Converting PDB Files Into ICM Objects

If you are going to make any energy calculation in ICM (eg docking, display H-bonds, display electrostatic and binding property surfaces etc..) it is necessary to convert a protein or chemical into an ICM object.

*To convert a PDB structure into an ICM object follow the steps shown below:*

- Right click on the name of the protein you wish to convert in the ICM Workspace.
- A dialog box will be displayed. Check the boxes as desired. If you are performing important calculations then it is necessary to optimize all hydrogens and ASN, GLU, PRO, and CYS.

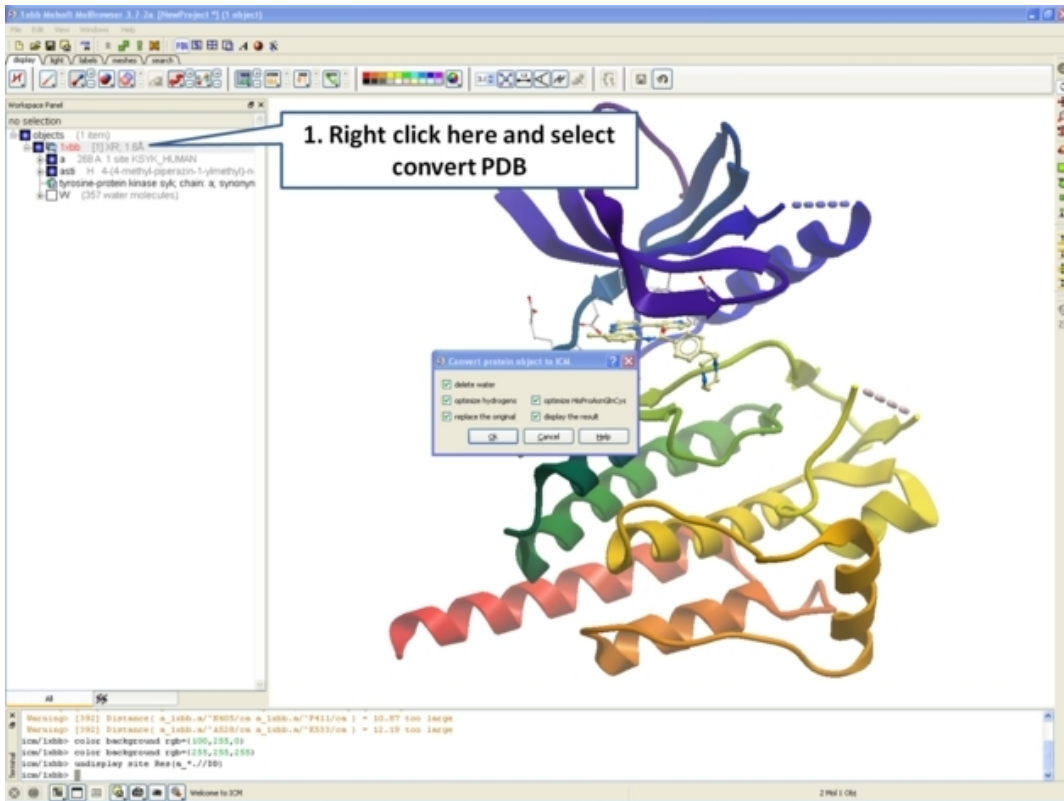

If your object is an ICM object it will tell you in the ICM Workspace:

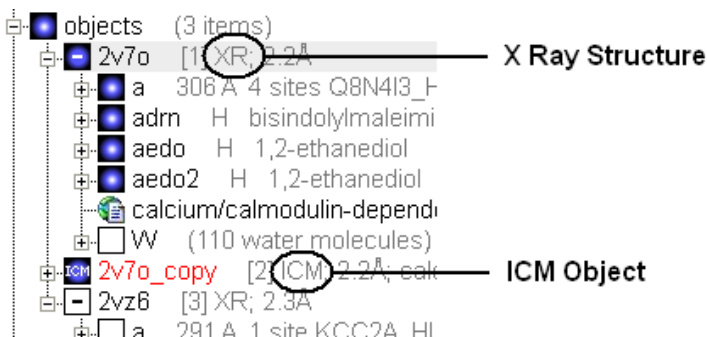

### 3.3 How to Display the Ligand Binding Pocket Surface and Neighboring Residues.

- As an example we will use the PDB structure 1STP. Type 1STP in the pdb search tab and press return.
- Convert the protein to an ICM object.
- Right click on the ligand "btn" and select "Ligand Pocket"
- To remove the ribbon display and display only the residues in the pocket. Select the "display" tab and click on the ribbon button which will undisplay the ribbon representation and leave only the residues surrounding the pocket.



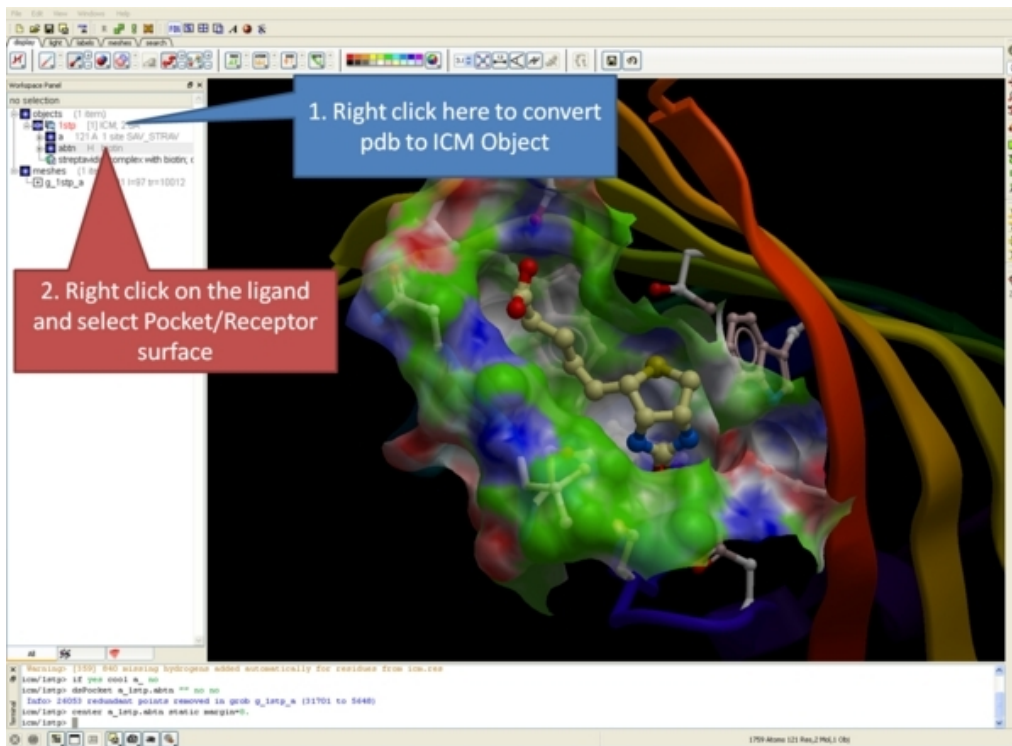

## 3.4 How to Display Hydrogen Bonds

**NOTE:** The method by which hydrogen bonds are calculated is described here in the command line manual. The GRAPHICS.hbondMinStrength parameter determines the hbond strength threshold for hbond display. The strength value is between 0. and 2. By changing 1. to 0.2 you will see more weak hydrogen bonds.

- As an example we will use the PDB structure 1STP. Type 1STP in the pdb search tab and press return.
- In order to display energy related properties we need to convert the PDB file into an ICM object. Convert 1STP into an ICM object. In this example, the option "Replace the Original" was selected.
- Display the receptor in wire format and the ligand in xstick.
- Right click on the ligand and select "Neighbors" – Enter 3 Angstroms and Type = Visible. Do not exclude source (the ligand) therefore remove tick from box entitled "exclude source".
- Select the display tab and then select the Display H–Bond button.

**2. Display all hydrogens and the residues/ligands**

**3. Click on the hydrogen button in the Display tab. Click and hold for more options**

**4. Left click = display/undisplay hbonds  
Right click = change hbond representation  
Click on + to see all hbond in list**

**1. Right click here and select convert PDB**

**Note: Right click on hbondpairs in ICM workspace to select residues making a hbond and also export to table**

```

icm/step: make hbond centers Resid_*_//SDI Resid_*_//SDI name="hbondpairs"
Info: 91 hydrogen bonds 'hbondpairs' (a_out) created. hTones[1_out]=91
icm/step: if Mod(hbondpairs)>0 display hbondpairs Resid_*_//SDI
icm/step: color background rgb=(255,255,255)
icm/step: color background rgb=(255,255,255)
icm/step:

```

**NOTE:** Different options for displaying the H–bond can be accessed by clicking and holding on the H–bond button in the "Display" tab. The coloring of the H–bonds are red (strong – thick spheres) to blue (weak – thin spheres). Once the hydrogen bonds have been displayed they can be displayed and undisplayed in the 3D labels section of the ICM Workspace (left hand side of graphical window).





# 4 Molecular Graphics

**Note:** Click **Next** (top right hand corner) to navigate through this chapter or use the links below. Headings are listed on the left hand side (web version) or by clicking the **Contents** button on the left-hand-side of the help window in the graphical user interface.

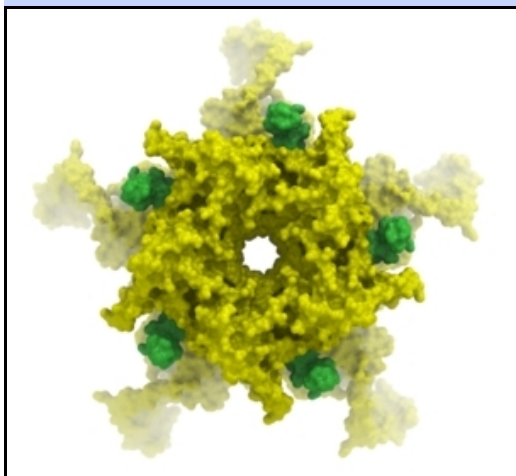

In this chapter we describe how to make beautiful graphical representations of molecules and manipulate them in the 3D graphics window. This includes how to change color, light, representations, clipping planes, and how to use built in graphics effects. We also teach how to label and annotate molecules displayed in the graphical user interface.

## 4.1 Molecule Representation

To change the molecule display representation:

- Select the atoms, residues, molecules, or objects you wish to change in the graphical display or in the ICM Workspace.
- Then use the molecule representation (e.g. wire, ribbon) options in the **Display** Tab.

The display tab contains tools for a variety of functions including – structural representations, coloring, labeling and superposition. This tab is shown below.



### 4.1.1 Structure Representation

There are six main types of structural representation in ICM. They are wire, ball and stick (Xstick), ribbon, skin, CPK and dot envelope (surface).

*To display one of these representations:*

- Click on the representation button you desire in the **display** tab.

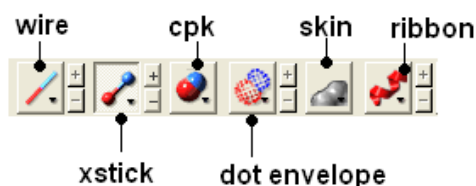

*To remove a displayed representation or to toggle between display and undisplay:*

- Click on the corresponding representation button in the **display** tab.

**NOTE:** The button display will change appearance (shaded) when pressed. This makes it easier to identify which representations are currently being displayed. Many characteristics of the graphical representation such as color can be changed by clicking and holding on the button or by clicking the plus(+) and minus(-) buttons next to them.

*Some examples of the representations you can choose:*

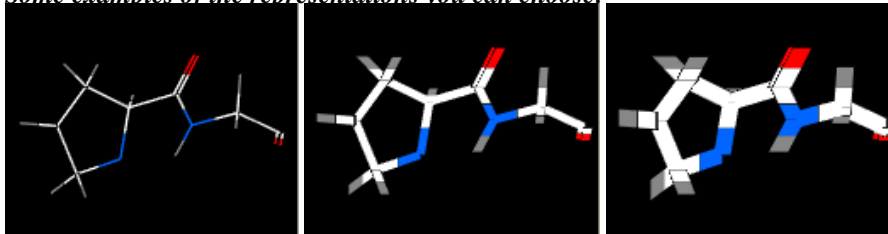

Wire : Thin Wire : Normal Wire : Thick

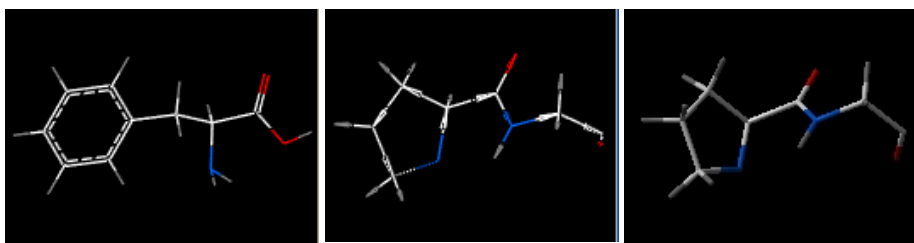

Wire : Chemistry Wire : Tree Xstick– Thin

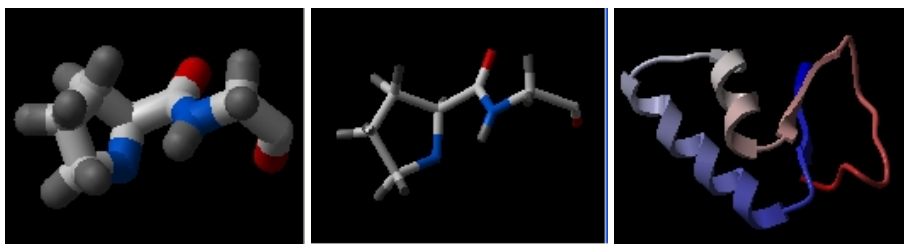

Xstick : Thick Xstick : Stick / Ball Ribbon : Ribbon



Ribbon : Segment Ribbon : Protein Worm Ribbon : Transparent

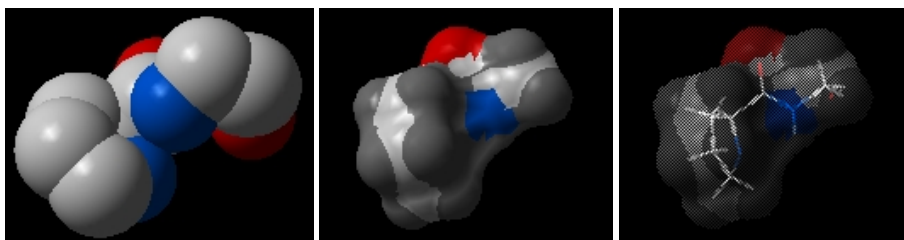

CPK : Default Skin : Default Skin : Transparent

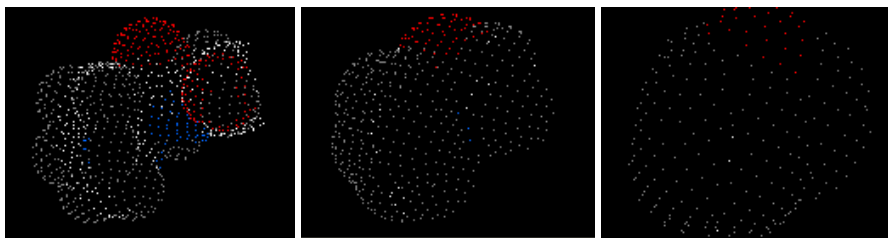

Surface : Tight Surface : Normal Surface – Sparse

## 4.1.2 Wire Representation

Click and hold on the **wire representation** button. A menu will be displayed as shown below.

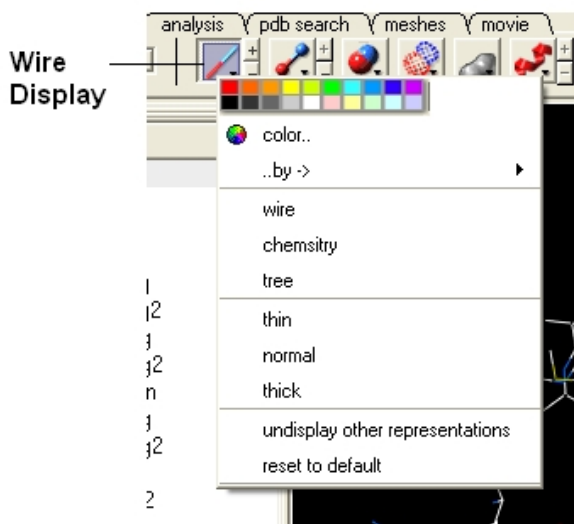

*To change the wire style:*

- Click and hold on the **wire representation** button and then click on **wire**, **chemistry** or **tree**.

*To change the size of the wire representation:*

- Click and hold on the **wire representation** button and then click on **thin**, **normal** or **thick**.

**NOTE:** Clicking on the +/- next to the **wire representation** button also changes the thickness of the wire representation.

*To undisplay representations other than wire:*

- Click and hold on the **wire representation** button and then click on undisplay other representations.

If you make a mistake or you are not happy with the way your structure is displayed with the wire representation:

- Click and hold on the **wire representation** button and then click on reset to default.

## 4.1.3 Stick and Ball (Xstick) Representation

Click and hold on the **stick and ball representation** button. A menu will be displayed as shown below.

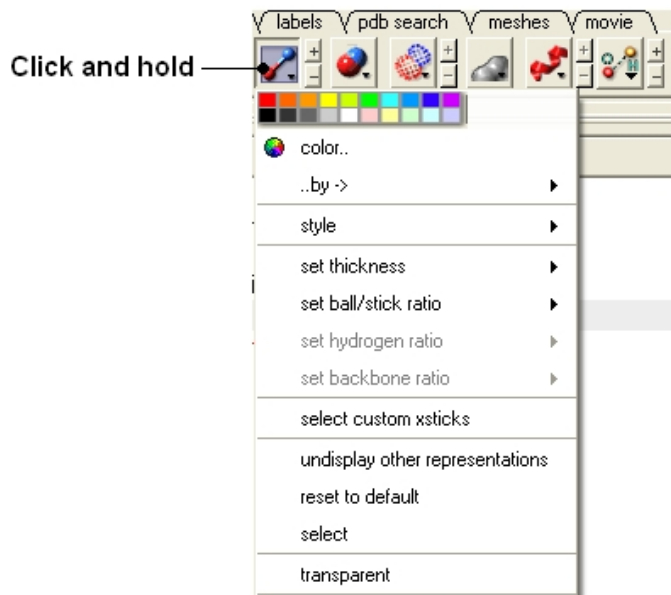

**To change the style of the Xstick representation:**

- Click and hold on the **stick and ball representation** button and then click on style. Choose a style as shown below.

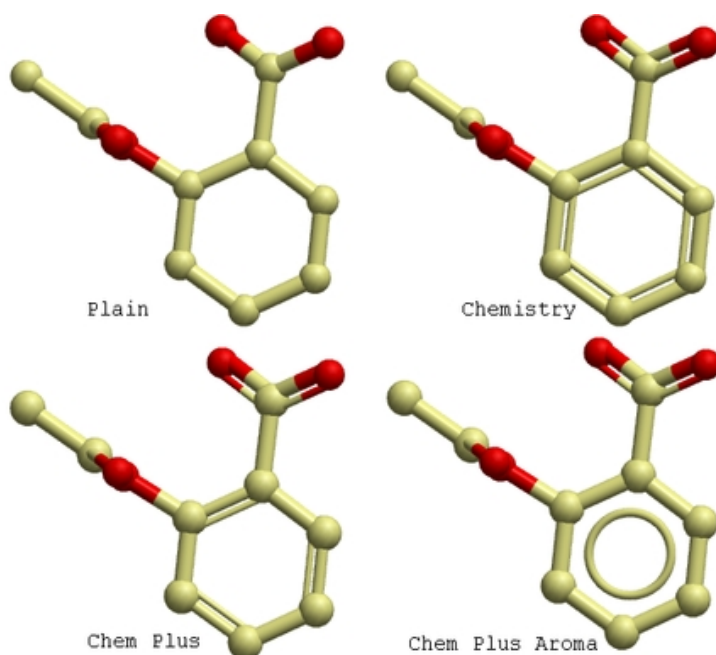

**To change the size of the Xstick representation:**

- Click and hold on the **stick and ball representation** button and then click on **set thickness** , **set ball/stick ratio**, **set hydrogen ratio**, and **set backbone ration**.

**NOTE:** Clicking on the +/- next to the **xstick representation** button also changes the thickness of the xstick representation.

**In order to make some parts of your picture clearer, the xstick representation can be set to transparent:**

- Click and hold on the **stick and ball representation** button and then click on transparent.

**To undisplay representations other than xstick:**



- Click and hold on the **stick and ball representation button** and then click on undisplay other representations.

*If you make a mistake or you are not happy with the way your structure is displayed with the xstick representation:*

- Click and hold on the **stick and ball representation button** and then click on reset to default.

#### 4.1.4 Ribbon Representation

Click and hold on the ribbon representation button. A menu will be displayed as shown below.

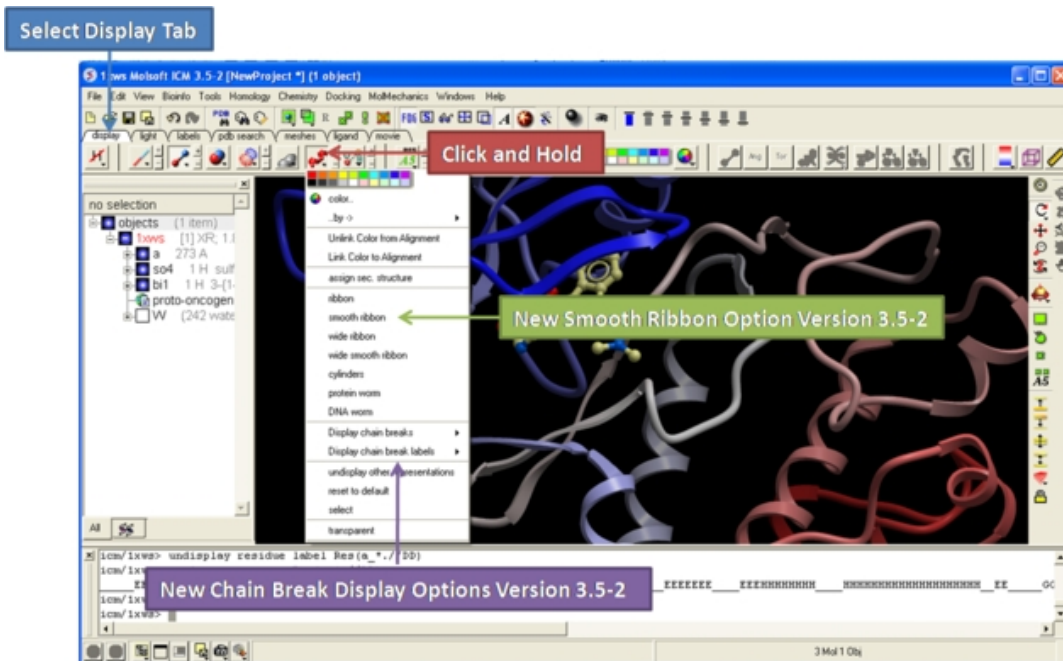

*To change the style of the Ribbon representation:*

- Click and hold on the **ribbon representation button** and then click on a style option.

To accurately represent the secondary structure of the molecule in ribbon representation you may wish to assign secondary structure:

- Click and hold on the **ribbon representation button** and then click on **assign sec. structure**. New in version 3.5–2 is they smooth ribbon style.

*To make some parts of your picture clearer, the ribbon representation can be set to transparent:*

- Click and hold on the **ribbon representation button** and then click on **transparent**.

*To undisplay representations other than ribbon:*

- Click and hold on the **ribbon representation button** and then click on undisplay other representations.

*If you make a mistake or you are not happy with the way your structure is displayed with the ribbon representation:*

- Click and hold on the **ribbon representation button** and then click on **reset to default**.

**NOTE:** Always use the ICM assign sec.\*\* structure tool in the ribbon right click menu to get accurate secondary structure assignment. This is particularly important when studying helices which may have non–canonical elements within them such as 3/10 or pi. To view non–canonical helix segments use

the segment option in the ribbon right click menu.

*To change the display of chain breaks (dotted lines):*

- Click and hold on the ribbon representation button.
- Select the options Display Chain Breaks or Display Chain Break label.

## 4.1.5 Skin Representation

Click and hold on the **skin representation button**. A menu will be displayed as shown below.

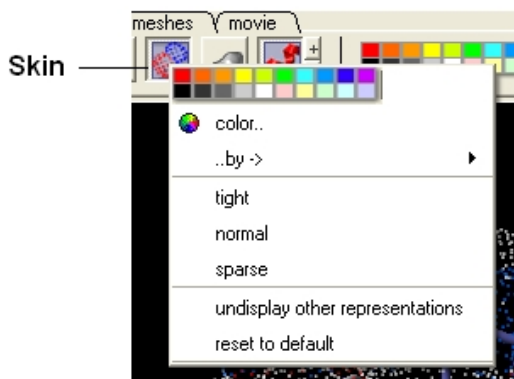

*To make some parts of your picture clearer, the skin representation can be set to tight, normal or sparse:*

- Click and hold on the **skin representation button** and then click on either tight, normal or sparse.

*To undisplay representations other than skin:*

- Click and hold on the **skin representation button** and then click on **undisplay other representations**.

*If you make a mistake or you are not happy with the way your structure is displayed with the skin representation:*

- Click and hold on the **skin representation button** and then click on **\*\* reset to default\*\***.

**NOTE:** Sometimes due to singularity problems holes may appear within the skin surface. To cure this infliction select atoms nearby and right click select Advanced->RandomizeAtoms

## 4.1.6 CPK Representation

Click and hold on the **CPK representation button**. A menu will be displayed as shown below.

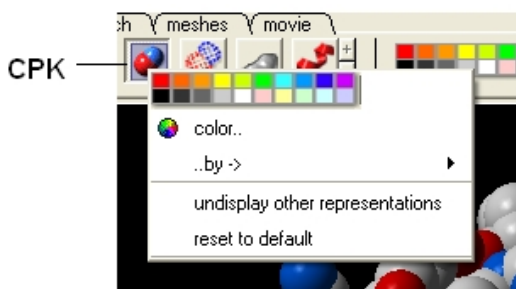

*To undisplay representations other than CPK:*

- Click and hold on the **CPK representation button** and then click on **undisplay other representations**.

*If you make a mistake or you are not happy with the way your structure is displayed with the cpk representation.*

- Click and hold on the **CPK representation button** and then click on **reset to default**.

## 4.1.7 Surface Representation

*Click and hold on the surface representation button. A menu will be displayed as shown below.*

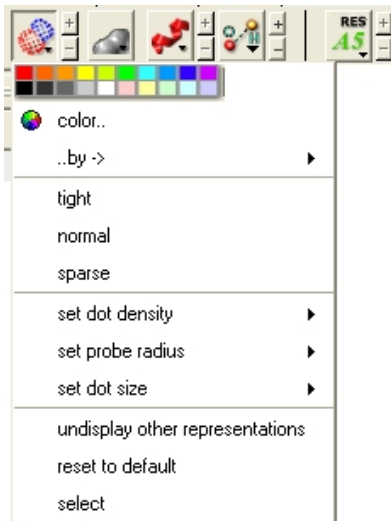

*To change the style of the surface representation:*

- Click and hold on the **surface representation button** and then click on **tight, normal, or surface**.

*To undisplay representations other than surface:*

- Click and hold on the **surface representation button** and then click on undisplay other representations.

*If you make a mistake or you are not happy with the way your structure is displayed with the surface representation:*

- Click and hold on the **surface representation button** and then click on **reset to default**.

## 4.1.8 Display and Undisplay Hydrogens

To display and undisplay hydrogens. Click and hold on the "**Change Hydrogen Display**" button shown below. Multiple single clicks will toggle through the hydrogen display options.

- Display Tab
- Click and hold on the "**Change Hydrogen Display**" button shown below.

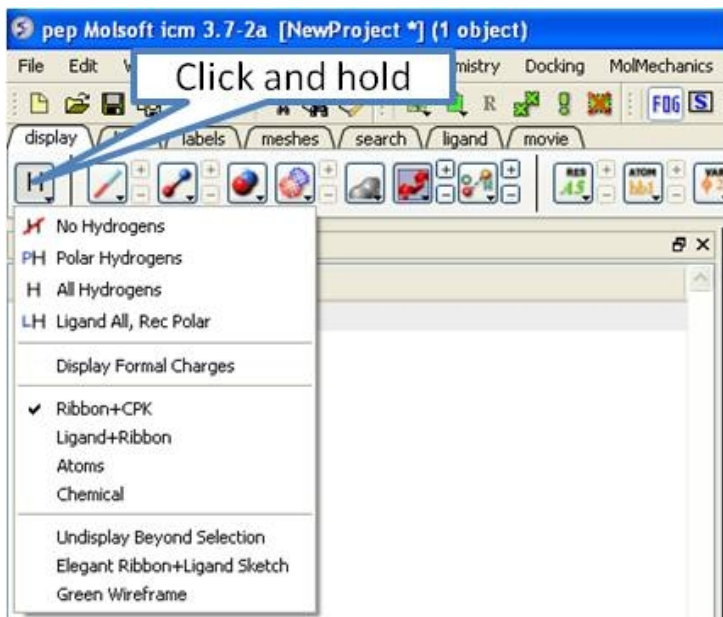

## 4.1.9 Display Hydrogen Bond

**NOTE:** The method by which hydrogen bonds are calculated is described here in the command line manual. The GRAPHICS.hbondMinStrength parameter determines the hbond strength threshold for hbond display. The strength value is between 0. and 2. By changing 1. to 0.2 you will see more weak hydrogen bonds.

In order to display potential hydrogen bonds in your structure:

- Convert to an ICM Object
- Make a selection – if you are trying to display the H–bonds between a ligand and the receptor make sure the ligand is part of the selection.
- Click the Display Tab.
- Click on the **Toggle H–bonds** icon in the **display** tab.

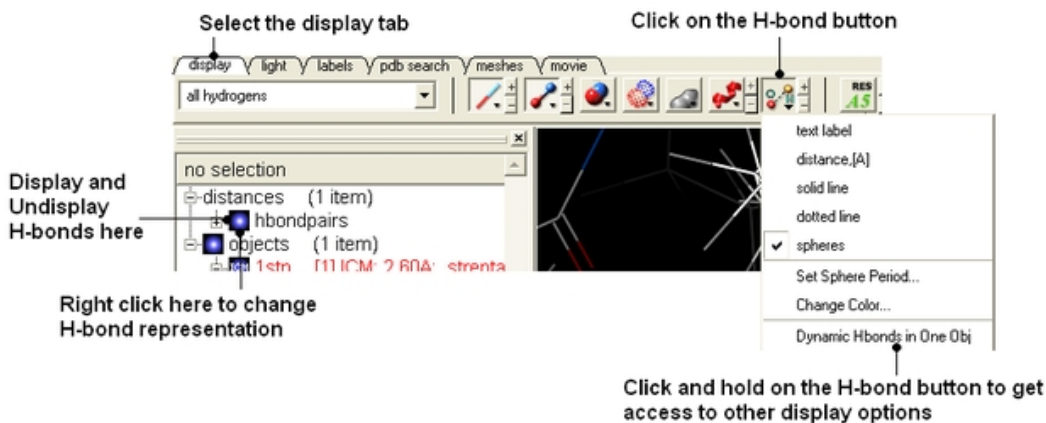

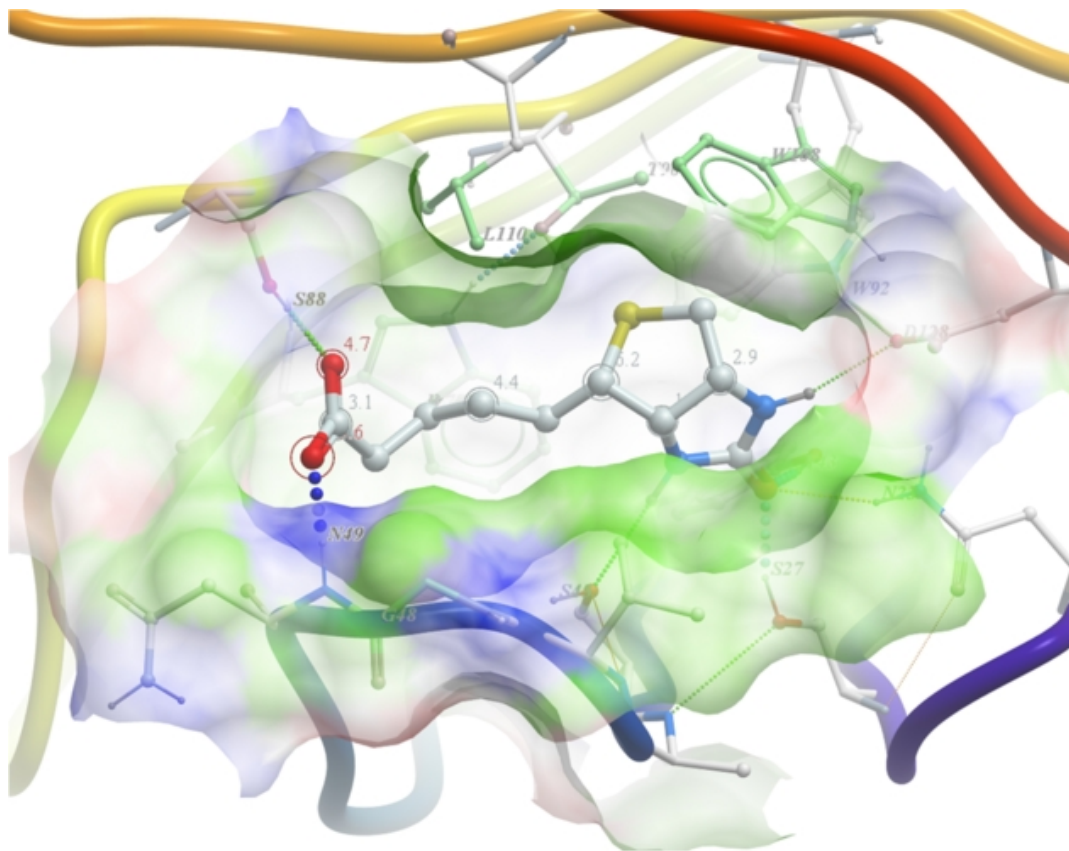

- Click the +/- on the right of the H-Bond button to change thickness of H-bond representation.
- Click and hold the button to change representation or use the **hbondpairs** option in the ICM Workspace.

Click and hold

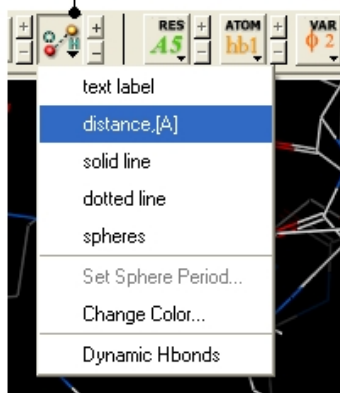

**What do the default coloring of the H-bond represent?**

Longer and shorter H-X distances in the hydrogen bond are color-coded, from red to blue, respectively.

**NOTE** Dynamic hydrogen bonds can be set by clicking and holding on the **H-bond toggle** button in the **Display** tab. Hydrogen bonds will then respond to any changes made to the ligand.

## 4.1.10 Display Formal Charges

You can display formal charges by clicking and holding on the "Change Hydrogen Display" button in the Display tab.

## 4.2 Meshes – Surface – Grobs

Click on the tab button entitled 'meshes' and more graphics tools for surfaces are available. In ICM surfaces are sometimes referred to as meshes or graphical objects (Grobs).

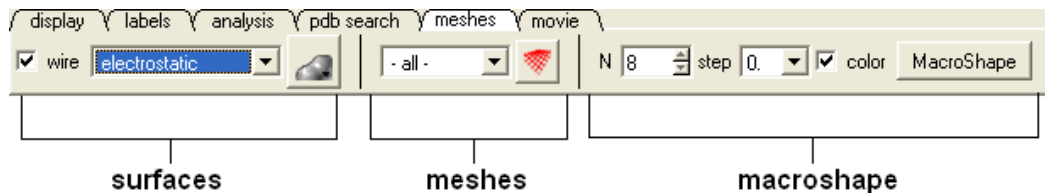

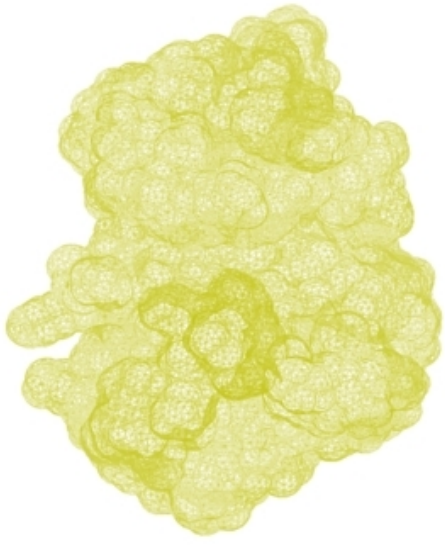
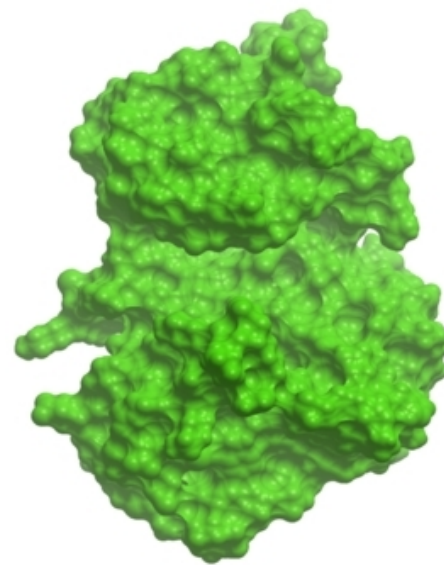
	
Surface	Plain Solid

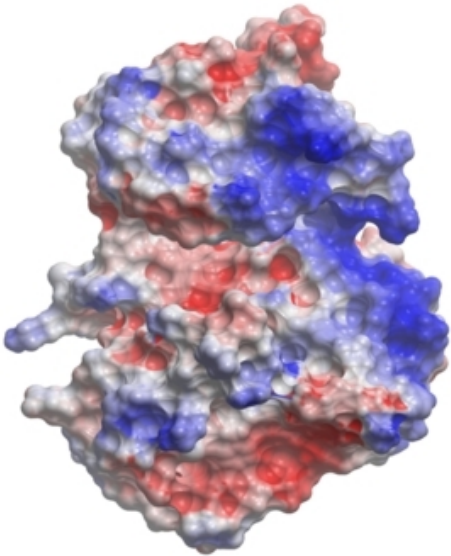
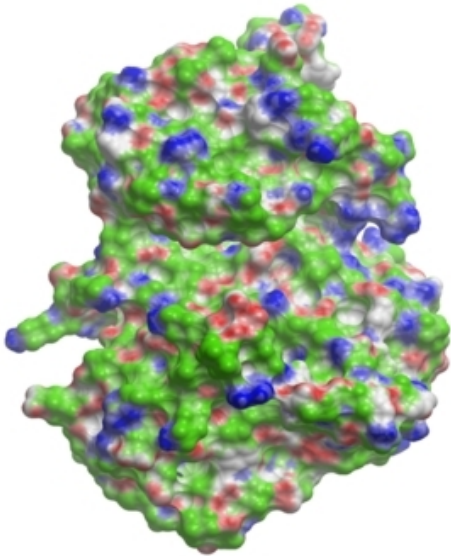
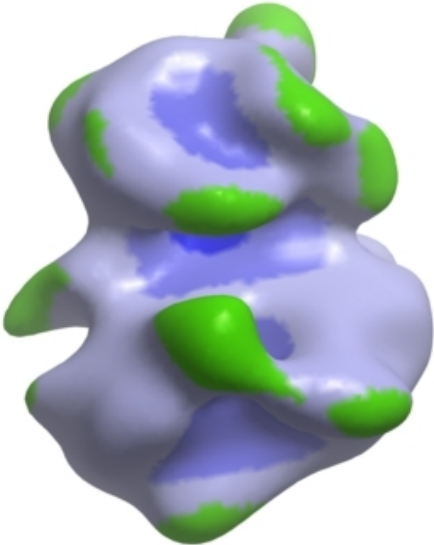
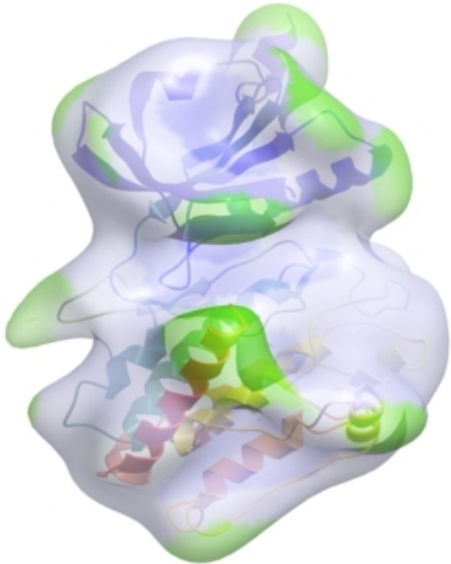
	
Electrostatic Surface	Binding Property Surface
	
Macroshape Solid	Macroshape Transparent

### 4.2.1 Surfaces

The surface of your structure can be displayed and colored by **electrostatics** or **binding** properties. To do this:

- Load a structure into ICM File/Open or tab-pdb{PDB Search}
- Convert the structure into an ICM object.
- Select the 'meshes' tab button.
- Click on the drop down arrow menu shown below and select which surface you wish to generate.
- Click on the generate surface button next to the drop down arrow.



### 4.2.2 Meshes

A variety of shapes can be constructed automatically using ICM. These shapes are referred to as meshes. The types of shapes you can build are shown below:

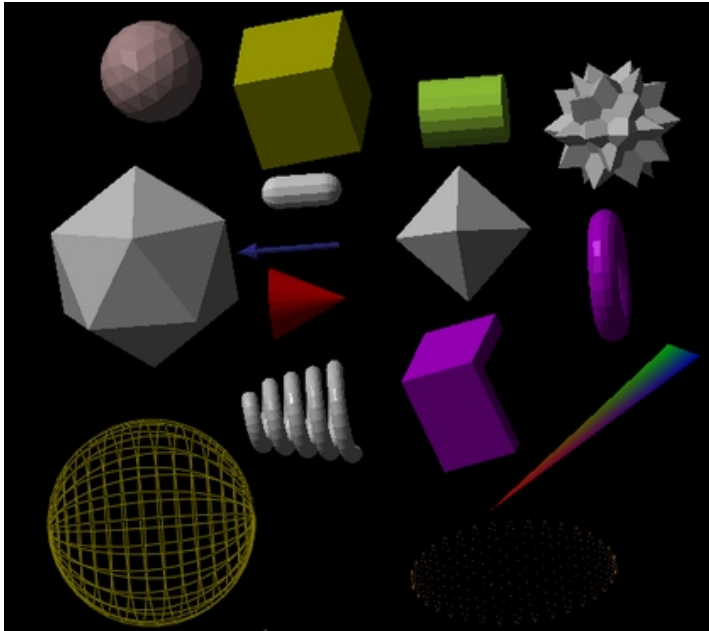

All the buttons for creating these shapes are shown here:

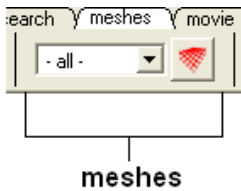

To make a shape select it from the menu by clicking on the down arrow and then click the button next to the menu. The shape will then be displayed in the 3D graphics window.

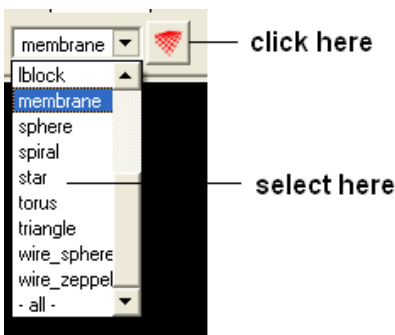



### 4.2.3 Macroshape

A macroshape can be constructed and allows easy viewing and manipulation of the structural representation. A macroshape representation is ideal for large structures which allows the user to easily identify important regions of the structure and facilitate the return to the 'standard' view of a particular molecule. All the buttons needed to display a macroshape structure are shown below in the 'meshes' tab.

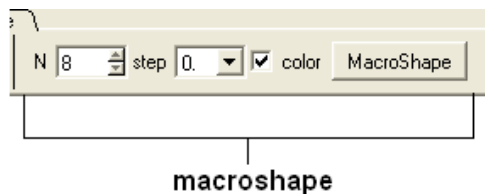

*To construct a macroshape:*

- Load a molecule into ICM File/Open or tab-pdb{PDB Search}
- Select the amount of detail required in the shape by increasing the values in 'N' or 'step' data entry box (note the default values are usually sufficient).
- Check the 'color' if you wish your molecule to be colored.
- Click the button labeled 'MacroShape'.

Macroshape can also be used from the View menu: View/Macro Shape

### 4.2.4 Google 3D Objects (Sketchup)

*To read in a 3D Mesh from Google in KMZ or COLLADA format:*

- File/Load/ 3D Mesh in KMZ or COLLADA Format from Google
- Search for the object you would like to view and download it.
- To read the file go to File/Open

An example of a KMZ file can be found in the distribution (a squirrel model by **ilikipie**, provided with author's permission).

- File/Open, and choose the squirrel.kmz file

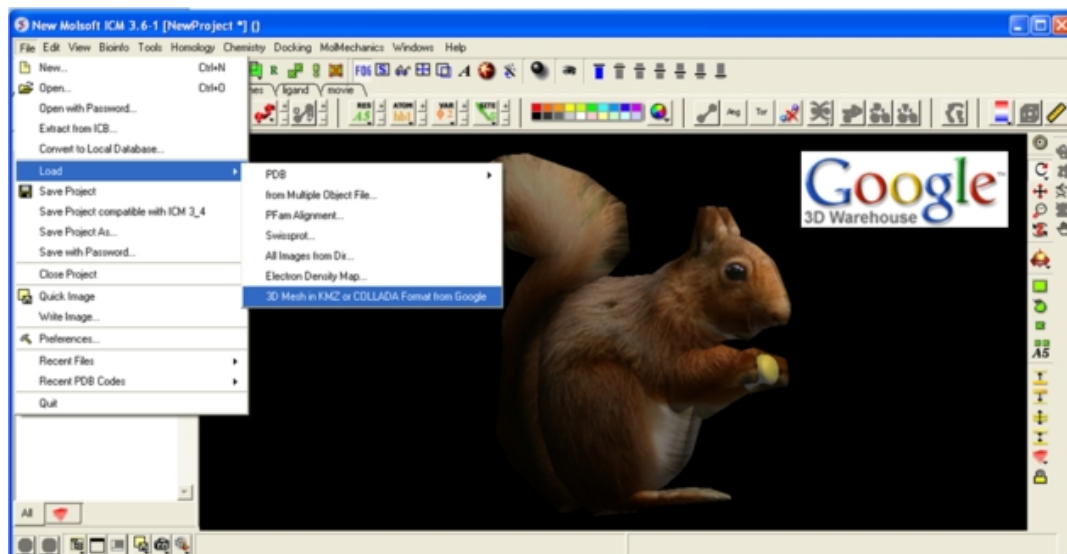

### 4.2.5 Display or Undisplay Meshes or Surfaces

To display or undisplay the surface click in the box in the ICM workspace as shown below:

## ICM Workspace

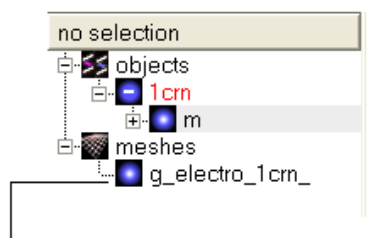

check here to display  
or undisplay surface

**NOTE:** All surfaces, meshes and macroshapes come under the one heading of **meshes** in the workspace panel.

### 4.2.6 Mesh Options.

A number of options relating to meshes can be used by right clicking on the mesh in the ICM Workspace. This section describes some of these options.

### 4.2.7 Move and Resize Mesh

Once a mesh has been created you can move it and resize it. To do this, locate the mesh you wish to either move or resize in the ICM Workspace and right click on it as shown below.

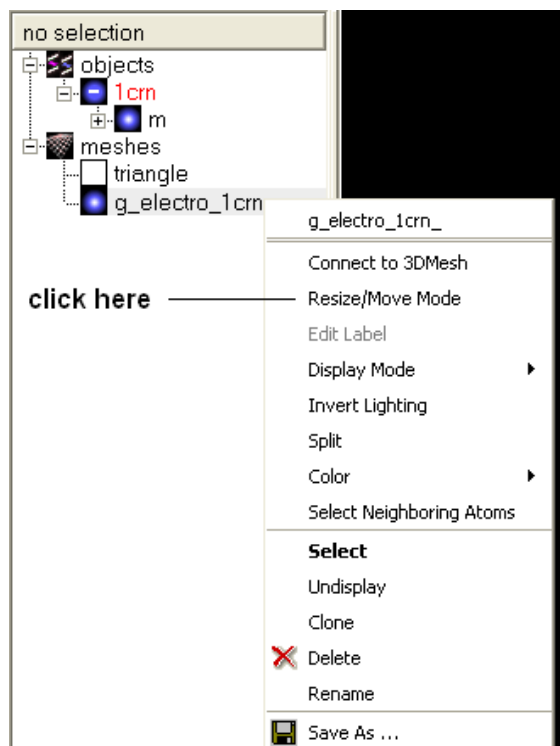

- Select the **Resize/Move Mode** in the menu.

A purple box as shown below will surround the molecule.

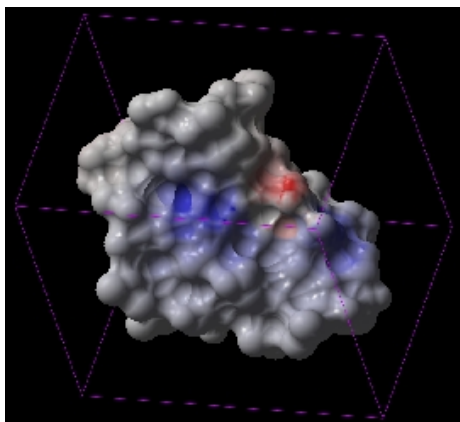

To resize the mesh click on one of the corners of the box and drag to the required size. The number displayed on the edges of the box represent the dimensions.

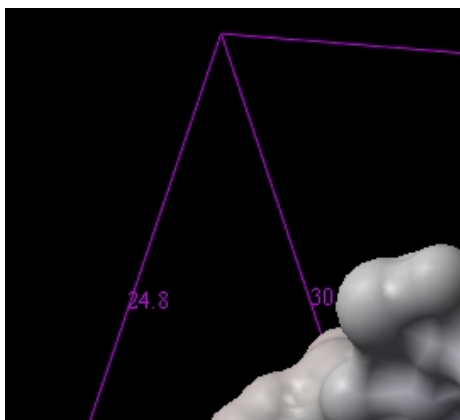

To move the mesh click on it with the center mouse button or select the connect option.

#### **4.2.8 Color and Mesh Display**

There are a number of options to color and change the display of the mesh. These options can be accessed simply by right clicking on the mesh name in the ICM Workspace as shown below.

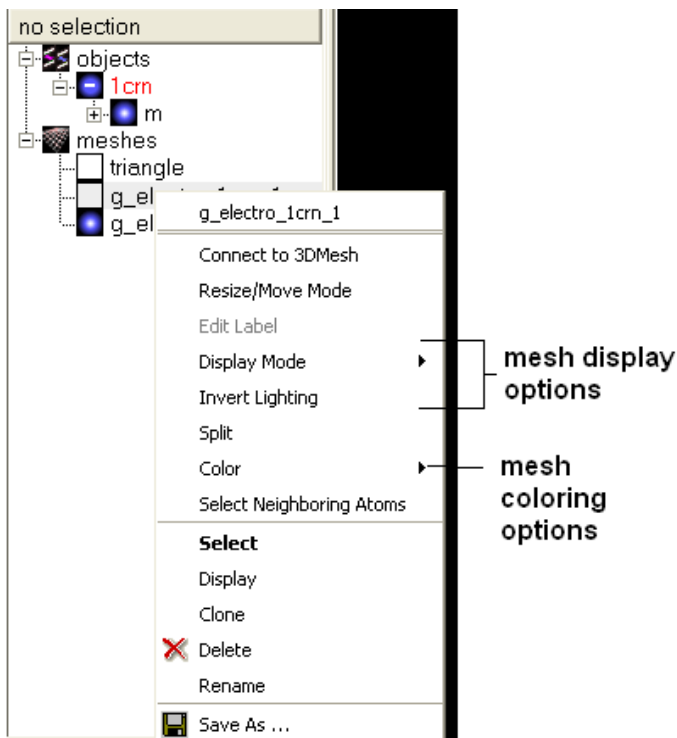

The lighting and display can be changed by selecting the options 'Display Mode' or 'Invert Lighting'.

There are five different display modes as shown below:

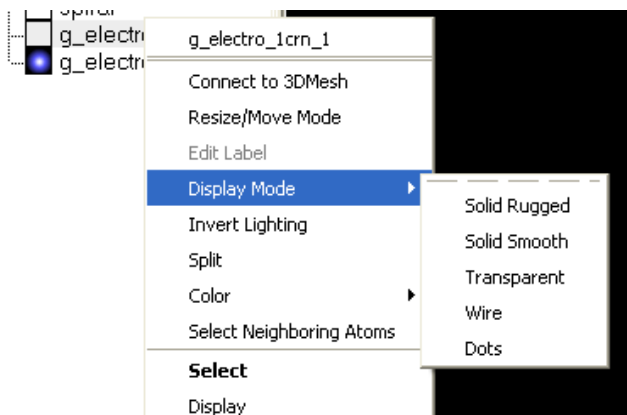

To change the lighting effects select 'Invert Lighting'.

The mesh colors can be changed by using the 'Color' option in the menu.

### 4.2.9 Mesh Clipping

Clipping tools can be used to adjust the frames of the mesh independently of other objects.

The buttons shown below can be used for this purpose.

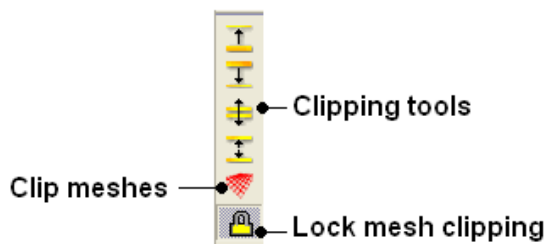

The buttons used for clipping are described in the section entitled **Clipping Tools**.

#### 4.2.10 Save Mesh

You can save a mesh as a wavefront object by right clicking on the mesh in the ICM Workspace and selecting **SaveAs**.

#### 4.2.11 Occlusion Shading

The occlusion shading option provides better representation of depth within a cavity. The color of each surface element of a grob (mesh) is changed by mixing its own color with the background depending on the burial of the surface element

*To add occlusion shading:*

- Right click on the mesh in the ICM Workspace and select **Occlusion Shading**.
- Enter a depth value – default is 0.8. Higher values will generate a more dramatic shading.

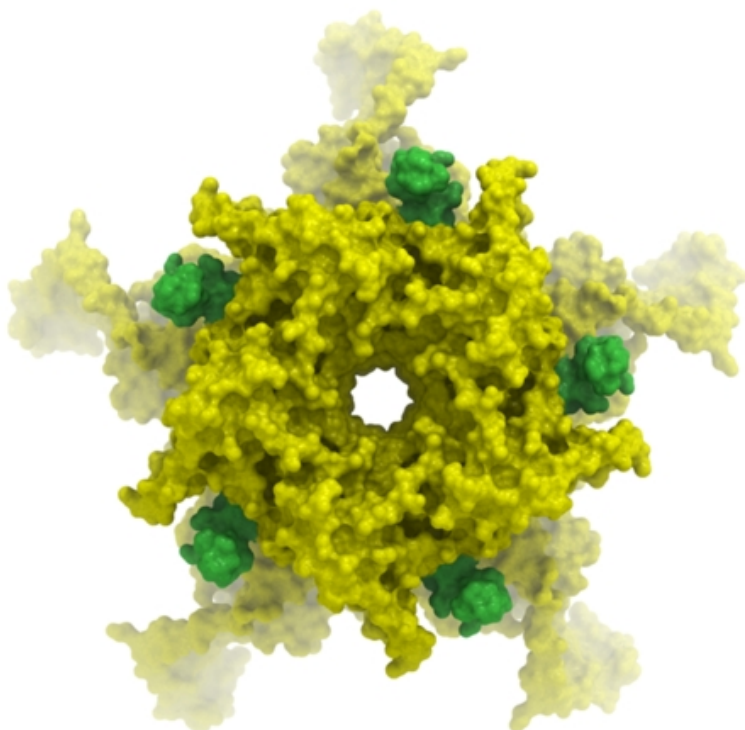

### 4.3 Coloring

To change the coloring of the molecules:

- Select the atoms, residues, molecules, or objects you wish to color in the graphical display or in the ICM Workspace.
- Then use the color options in the Display Tab.

### 4.3.1 Coloring

*To change the color of a structural representation such as CPK, Xstick, wire or ribbon.*

- Click and hold on the structural representation button for the representation you wish to color (e.g. wire, ribbon etc...) in the **Display** tab.
- Select a color by clicking color.

*To color by a particular parameter such as atom type, b-factor, secondary structure etc...*

- Click and hold on the structural representation button for the representation you wish to color (e.g. wire, ribbon etc...) in the **Display** tab.
- Select `..by->` option

*To change the color of the whole of your displayed structure:*

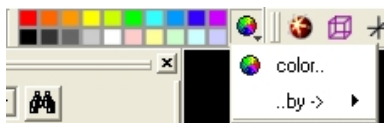

- Click on the color palate displayed on the toolbar.
- If you are not satisfied with these colors, click on the color wheel on the toolbar. A window as shown below will be displayed. Select the desired color by either clicking on one of the basic colors or by selecting the desired color on the right hand side of the window.

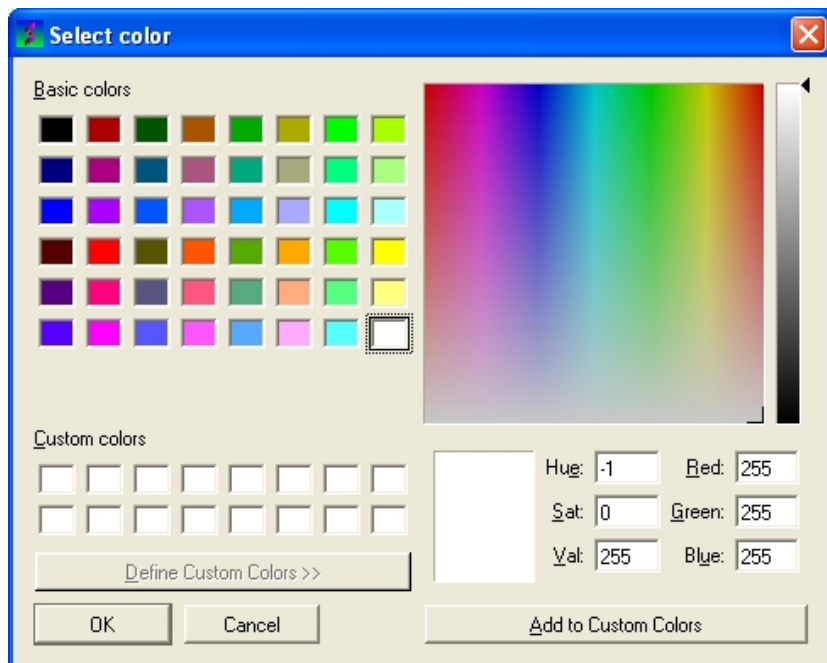

- Once the desired color has been selected it can be added to custom colors for future use by clicking on the Add to Custom Colors button.
- Click the **OK** button and the color will be applied to the structure.

### 4.3.2 Color Background

*To change the color of the background:*

- Select **View/Color** background.

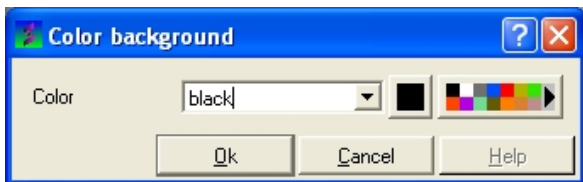

- Click on the square of your desired color. If you are not satisfied with the color palate, click on the arrow next to the colors to customize a color.

**OR**

- Right click on a color in the colors panel in the display tab.



Right click here in the display panel to set the background color.

### 4.3.3 Background Image

REQ\_352

A background image can be added to the graphical display. This can be useful for making cool images or for comparing structures (e.g. compare displayed object with background image of object).

*To add a background image from an image file (png or jpeg):*

- File/Open Image
- Right click on the image in the ICM Workspace and select "Set as Background in Graphics."

*To set currently display as background image:*

- Click and hold on the "Copy Image to Clipboard" button at the bottom of the gui and select the "Set as Background" option.

*To remove a background image:*

- Select the **display** tab and then click and hold on the color sphere button and select "Remove Background Image".

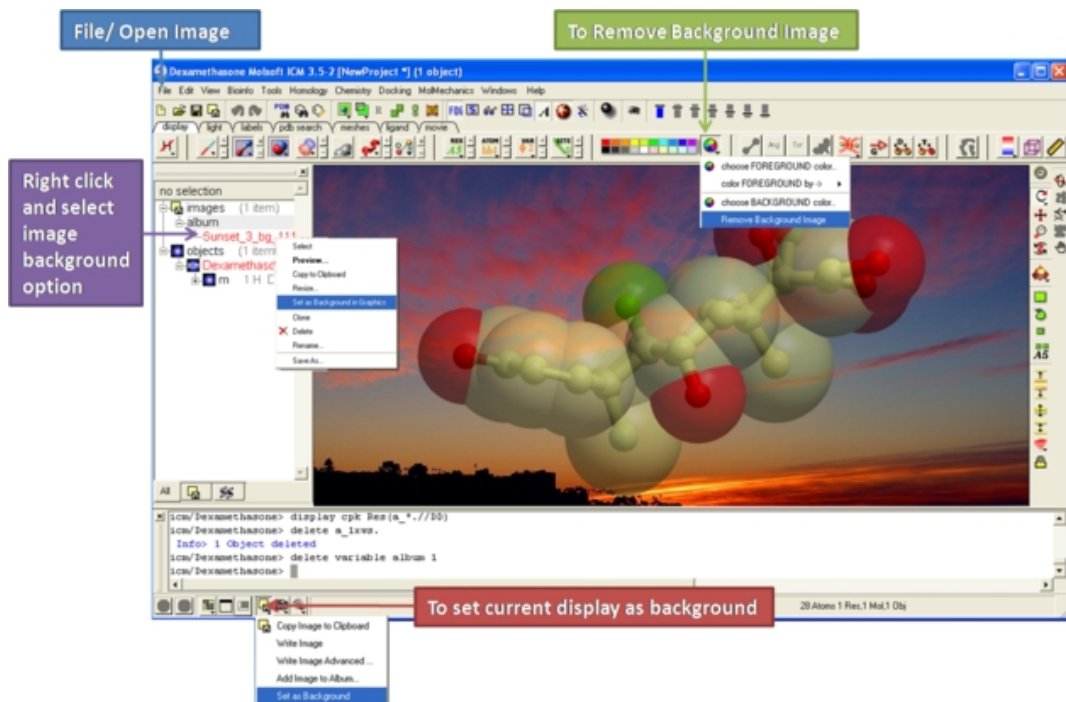

## 4.4 Lighting

These options are in the light-tab{light tab}

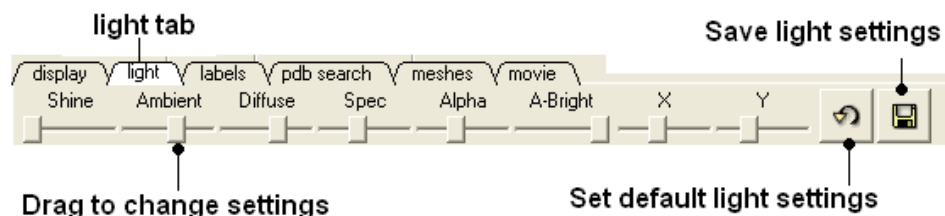

Click and drag the sliders to change the lighting. You can also save your preferred lighting settings and return to default.

**Shine** – shininess property of the solid material

**Ambient** – ambient light intensity of RGB for ambient light

**Diffuse** – diffuse light intensity of RGB for diffuse light

**Spec** – specular light intensity of RGB for specular light

**Alpha** – transparency setting for grob

**A-Bright** – light intensity shinning on grob

**X and Y** – Change the position of the light source in the graphics window

## 4.5 Labeling and Annotation

To add labels or display or undisplay pre-defined annotation:

- Select the atoms, residues, molecules, or objects you wish to label in the graphical display or in the ICM Workspace.
- Then use the label options in the Display Tab.



To add new user-defined annotation:

- Select the atoms, residues, molecules, or objects you wish to label in the graphical display or in the ICM Workspace.
- Right click on the selection and choose "Annotate Selection".

## 4.5.1 Labeling

Labeling options are contained within the Labels or Display Tab. In many cases clicking and holding a label button will allow you to view more options.

## 4.5.2 Labeling Atoms

Select the atoms you wish to label (see `display structure` or `selection toolbar`).

- Select the **display** tab.
- Click the **label ATOM** button.

Click and hold to change label options

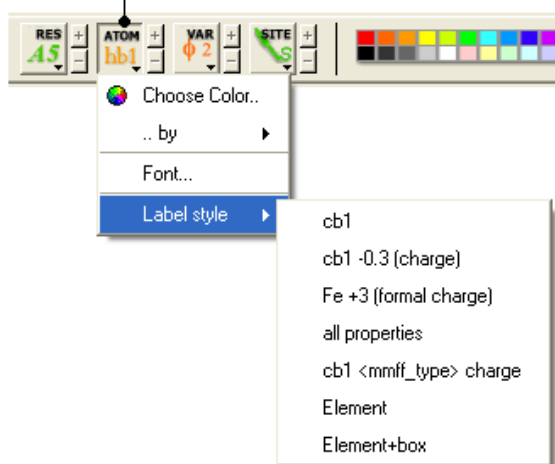

*To change the level of label detail:*

- Click and hold the **label ATOM** button and select the desired level of label detail, color or style.

## 4.5.3 Labeling Residues

*To label residues:*

- Select the **display** tab.
- Select the residues you wish to label (see `display structure` or `selection toolbar`).
- Click the **label RES** button.

Click and hold for more options

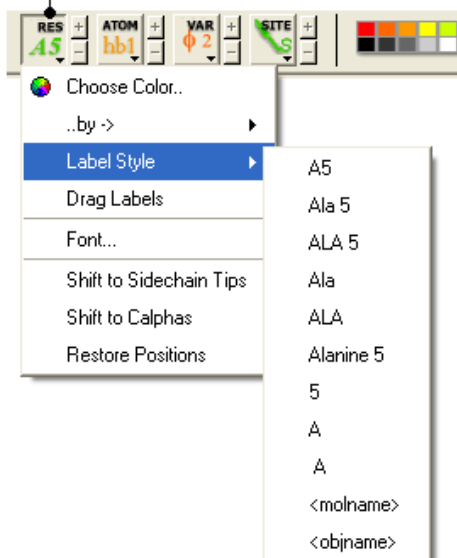

*To change the level of label detail:*

- Click and hold the **label RES** button and select the desired level of label detail or style.

#### 4.5.4 Move Residue Label

*To change the location of your residue label:*

- Select View/Drag res labels.
- If your mouse has a middle mouse button, then click on handle (as shown) of the label you wish to move, and drag it to your desired area.

Click on  
this area  
to drag  
your  
label.



- If your mouse has no middle mouse button, then click on the Translation icon on the toolbar, and click on the handle (as shown) of the label you wish to move, and drag it to your desired area.

The +/- buttons on the side of the Residue and Atom buttons will shift the label. There are also other **residue label move** options available when you click and hold the residue label button. These options include **Shift to Sidechain Tips**, **Shift to Calphas**, and **Restore Positions**

#### 4.5.5 Label Variables

*To label variable angles (dihedral–torsion, planar and phase angle) the molecule needs to be converted into an ICM object.*

- Convert the molecule to an ICM object.
- Select the atoms for which you would like to display the variables (see `display structure` or `selection` toolbar).
- Click on the **toggle variable label** button shown above located in the **display** tab.
- Change the font size by using the +/- buttons.
- Change the font and color by clicking and holding on the variable atom label button.

To change the variable label style click and hold the variable atom label button as shown below.

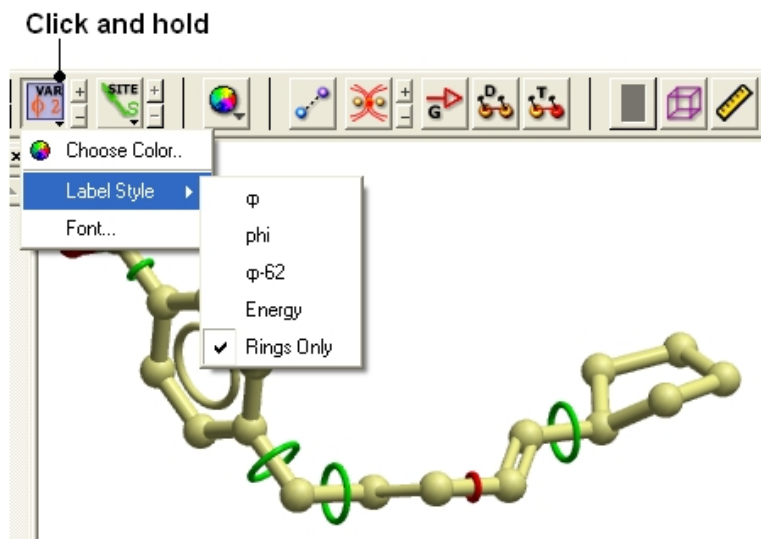

Green rings = rotatable  
Red rings = constrained

Rings of varying diameter and color are superimposed on rotatable bonds. Green rings with large diameter are considered less constrained than rings with small green rings. Red rings are highly constrained and non-rotatable. When the **Label Style/Energy** option is selected the first number displayed represents the bond angle, the second the energy and the third the worst energy that could be achieved by rotating the bond.

#### 4.5.6 Labeling Sites

To display and undisplay sites use the *Toggle Site Label* button shown below

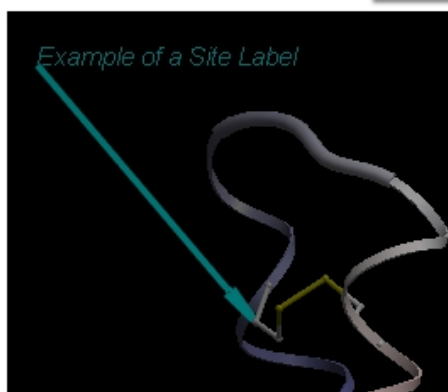

- Click the **label SITE** button.

To change the level of label detail:

- Click and hold the **label SITE** button and select the desired level of label detail or style.

**NOTE:** To create your own site labels see the **Label Annotation** section.

## 4.5.7 Annotation

To annotate a protein structure. Select the region you wish to annotate (see Selection Toolbar).

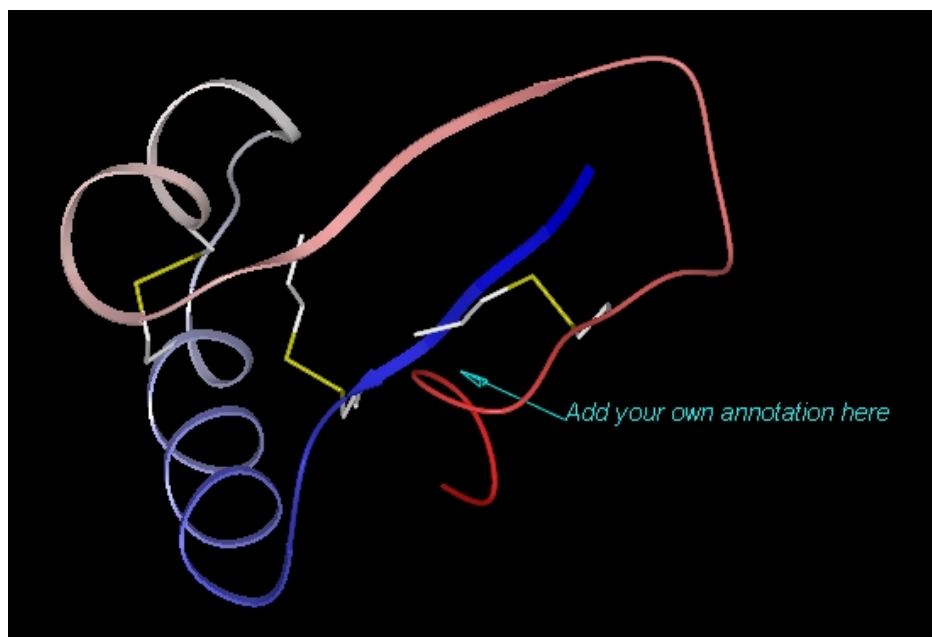

- Right click on the selection.
- Select the option **Annotate Selection**.
- Enter the annotation into the text box and select ok

To change the detail (such as residue number) contained within the annotation.

- Click in the bottom left hand corner of your annotation.

To undisplay an annotation click on the site button in the Display tab.

To permanently delete an annotation.

- Right click on the Sites box in the ICM Workspace and select delete (see below).

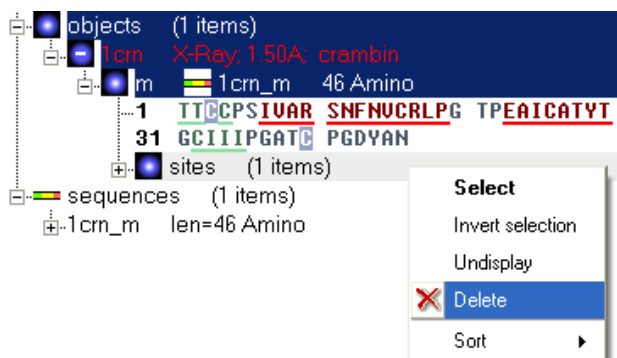

To change the direction the arrow is pointing or move the arrow.

- Click on the translation button (or use the middle mouse button).
- Click on the end of the arrow and drag to the desired position.

## 4.5.8 Changing Label Colors

*To change the color of any label:*

- Click and hold down the required label button and a menu as shown below will be displayed.



- Select **color**.

## 4.5.9 Customized Label 2D or 3D

To generate a customized a label:

- Select the **labels** tab.
- Select either 2D or 3D button.
- Enter your label and select the desired color, font and size.

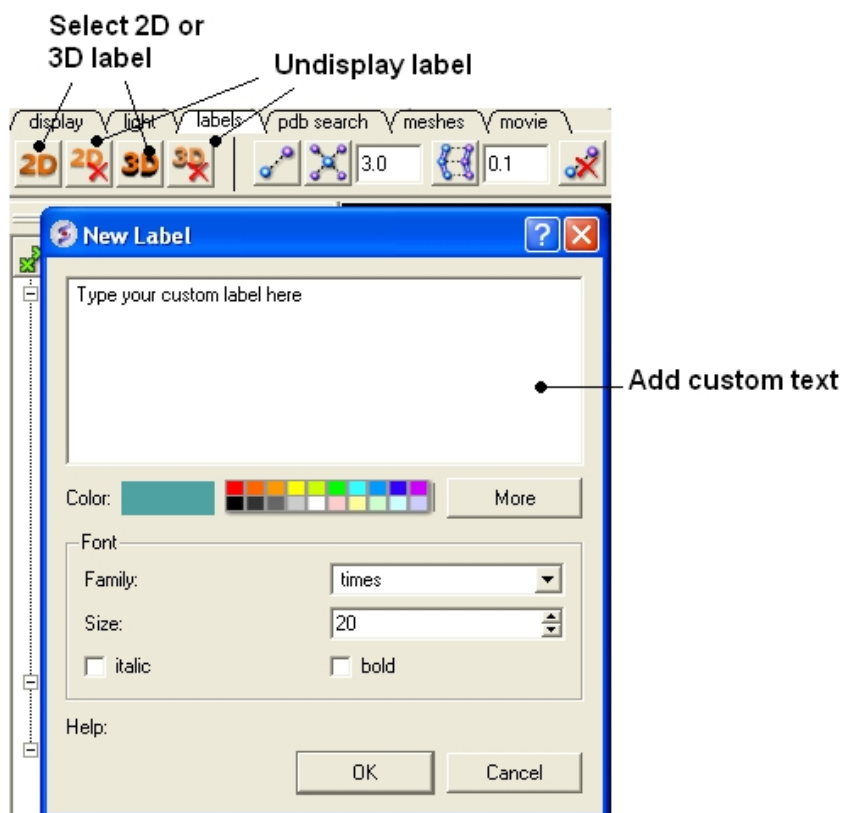

To **edit** or **delete** a label – right click on the label in the graphical display as shown below.

Right click here to Edit or Delete label

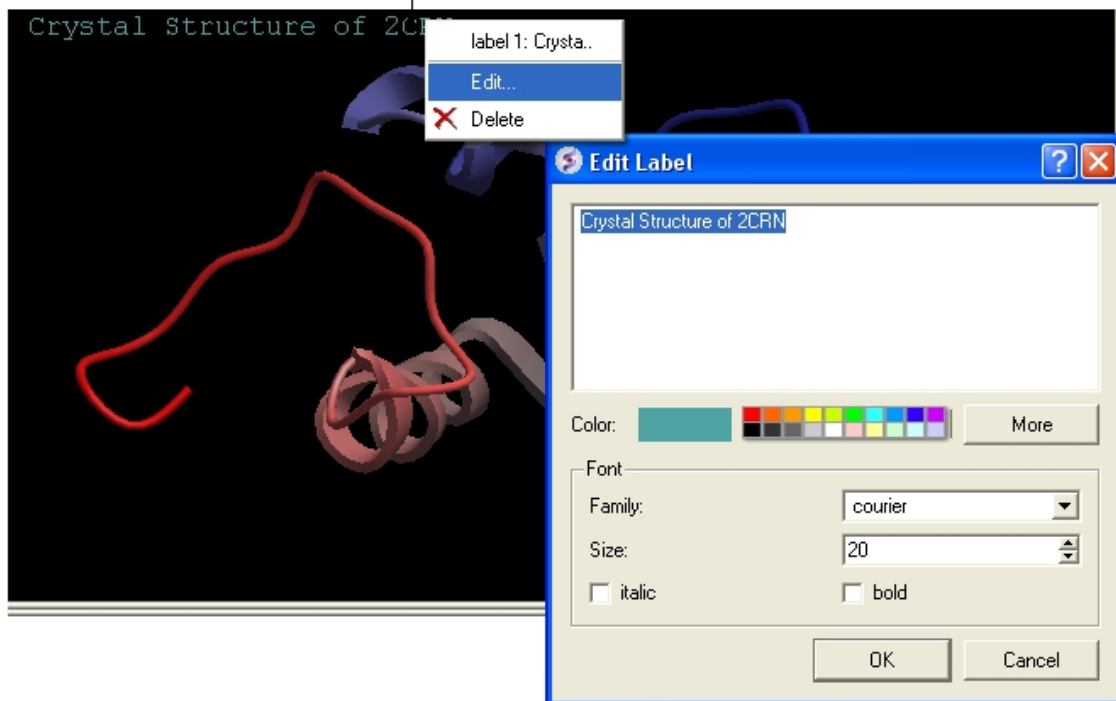

#### 4.5.10 Undisplay Customized Label

**Undisplay Residue, Atom, and Variable Label** Any label that is displayed can be undisplayed by selecting the region of the molecule related to the label and clicking on the corresponding label button in the labels tab. For example if you wish to undisplay an atom label – click the atom label button. If a label is displayed the corresponding button in the **display** tab will be shaded blue. When you delete the button will return to grey. 2D and 3D labels have an undisplay button (red cross on the button see customized label section).

**Undisplay 2D or 3D label** Click on the undisplay label button in **labels** tab.

**NOTE:** A label can also be deleted by right clicking on the label in the graphical display and selecting **delete**.

#### 4.5.11 Labeling Distances

Within the **labels** tab there are tools for calculating and displaying distances. These tools can also be found in the Tools/Analysis menu.

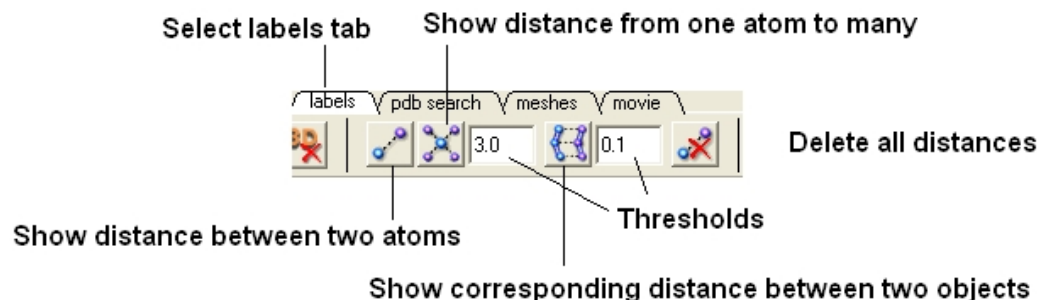

*To display distance between two atoms:*

- Click on the labels tab (previously called advanced tab).
- Select the atoms between which you would like to find the distance. (See selection toolbar)
- Click on the 'Show Distances Between Two Atoms' Button
- The distance will be displayed in angstroms, in green.

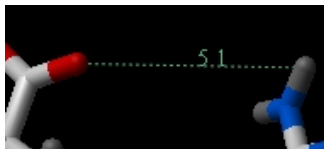

*To find the distance from one atom to many:*

- Click on the labels tab (previously called advanced tab).
- Select the atom from which you wish to measure the distance from (See selection toolbar)
- Click on the 'Show Distances From One Atom To Many' button.
- The distances will be displayed in green.

The maximal and minimal distances can be selected by entering values in the boxes shown here (below) in the labels tab (previously called Advanced tab).

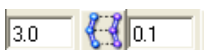

**NOTE:** Distances can be displayed and undisplayed in the 3D labels section of the ICM Workspace. See image below.

*To change the color of the distance label*

- Right click on the **distpairs** under the **3D labels** section of the ICM workspace and select **Change Color**.

#### 4.5.12 (Un)display Origin

*To display and undisplay the axis of the coordinate frame (origin):*

- Select the **labels** tab and select the **toggle origin** button.

Display or undisplay origin button - located in the labels tab

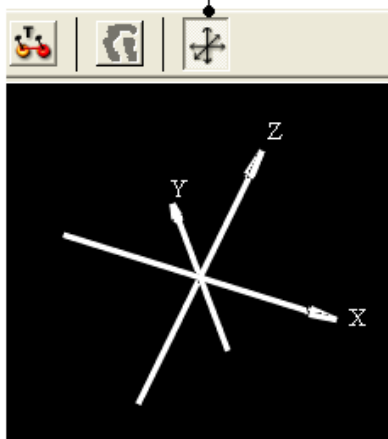

### 4.5.13 Displaying Tethers

#### *Theory*

A tether is a harmonic restraint pulling an atom in the current object to a static point in space. This point is represented by an atom in another object. Typically, it is used to relate the geometry of an ICM molecular object with that of, say, an X-ray structure whose geometry is considered as a target. Tethers can be imposed between atoms of an ICM-object and atoms belonging to another object, which is static and may be a non-ICM-object. You cannot create tethers in ICM-Browser, however, if the project that you have loaded contains tethers between two objects, then they can be displayed:

- Click on the **display tab** (previously called advanced tab).
- Click on the 'Toggle Tethers' button.

### 4.5.14 Displaying Distance Restraints

#### *Theory*

A distance restraint imposes a penalty function on the distance between two atoms in the same object. You cannot create distance restraints in ICM-Browser, however, if the project that you have loaded contains distance restraints, then they can be displayed:

- Click on the **display tab** (previously called advanced tab).
- Click on the 'Toggle distance restraints' button.

### 4.5.15 Display Clash

To display a clash the file needs to be an ICM Object.

- Select the region around which you would like to identify clashes.
- Select the display tabs and the "toggle clashes" button shown below.





## 4.5.16 Display Rainbow, Box, Ruler

To (un)display a rainbow key, box or ruler use the buttons shown below located in the **display** tab.

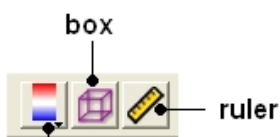

rainbow (click and hold to change colors)

## 4.5.17 Display Gradient

This button is located in the **display** tab.

Toggle energy gradient button

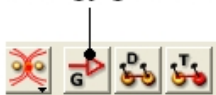

This option is described in detail in the language manual

<http://www.molsoft.com/man/icm-commands.html#display-gradient>

## 4.6 Display Distances and Angles

### 4.6.1 Display Distance Between Two Atoms – the quick way

- Click on the **Display** tab
- Click on the **Distance between two atoms** button shown below.
- Click on the atoms you wish to measure.
- Distance will be displayed in the graphical display. You can turn this on and off in the ICM Workspace panel under the heading **3D labels**.

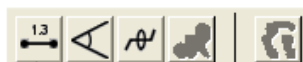

Display distance

### 4.6.2 Display Planar Angle

- Select the **display** tab.
- Select three atoms.
- Select the button shown below.

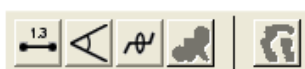

Display planar angle

**NOTE:** This option is also available in the Tools/Analysis menu.

### 4.6.3 Display Dihedral Angle

- Select the **display** tab.
- Select four atoms.
- Select the button shown below.

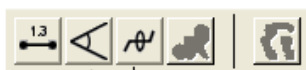

Dihedral angle

**NOTE:** This option is also available in the Tools/Analysis menu.

### 4.6.4 Delete Label

To delete distance or angle labels

- Select the **display** tab.
- Select the delete distance or angle label button shown below.

Delete distance or angle labels button in display tab

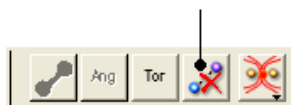

## 4.7 Graphics Effects

All the visual effects tools can be accessed by the View Menu or click on the corresponding button in the View Tools panel shown below.



### 4.7.1 Fog

**Fog Toggle**(Ctrl + D) : this feature creates a fog-like environment for your object, so that the part of your structure that is closer appears clear and the distant parts are faded as if they are in fog. The clipping planes control the point at which the fog begins.

- View/Fog

### 4.7.2 Shadows

- View/Shadows

OR

select the shadow button shown below.

### Toggle shadow

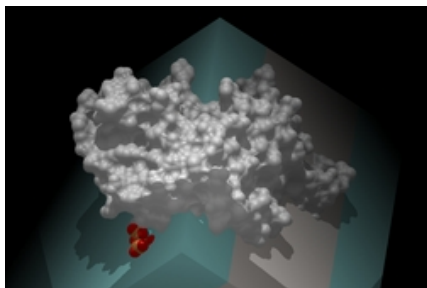

### 4.7.3 Sketch Accents

To make images as shown below use:

- View/Sketch Accents

### 4.7.4 Elegant Ribbon Ligand Sketch

- Display Tab
- Click and hold Hydrogen button
- Select Elegant Ribbon+Sketch

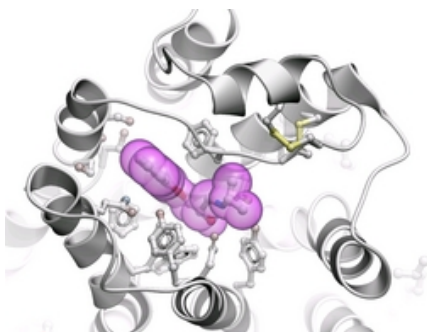

### 4.7.5 Perspective

**Toggle perspective** **Ctrl\_P** this will add perspective to your structure, enhancing depth in the graphical display.

- View/Perspective

### 4.7.6 Animate View

This tool is described in more detail in the [Molecular Animations and Transitions](#) section.

## 4.8 Graphics Shortcuts

The left mouse button can be mapped onto different graphics tools which can be selected from the right hand tool bar.

**Note:** (1) You can access many non-rotation modes directly from the rotation mode by using Middle and Right-mouse buttons, as well as by using the right, top and left margins of the graphics window. (2) You can access the rotation mode from non-rotation modes by pressing Ctrl.

- rotation ( **the default** , press Ctrl if you in the non-rotation modes )
- translation ( the middle mouse button in the rotation mode)
- zooming in and out by dragging the mouse up and down (the left margin in the rotation mode, or use the mouse **wheel**)
- Z-rotation ( the top margin in the rotation mode)
- selecting by box ( the right mouse click in the rotation mode )
- selecting by lasso ( Ctrl-draw lasso in the rotation mode )
- picking out atoms ( a toggle )
- picking out and labeling residues (a toggle)
- moving the front clipping plane ( the top section of the right margin in the rotation mode)
- moving the rear clipping plane ( the bottom section of the right margin in the rotation mode)
- moving the slab ( the middle section of right margin in the rotation mode)
- unclipping ( Ctrl-U )
- rotating torsions (Ctrl-left-mouse-click in the rotation mode)
- connect and unconnect separate molecules to movement controls

Many useful graphics tips are summarized [here](#).

**NOTE:** Key mouse controls are summarized in the command line manual [here](http://www.molsoft.com/man/graphics-controls.html)

## 4.9 Molecule Move Buttons

To move your structure it must first be displayed in the graphics window (for instructions on how to display a structure see the `Display` Tab). All of the following options are displayed in the Move Tools toolbar (shown below).

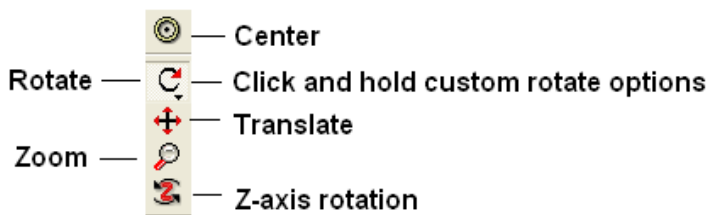

### 4.9.1 Rotation

*In order to achieve the best pose for a picture or to enable the study of a certain region of your structure in more detail you may need to rotate the structure:*

- Click on the **rotation** icon on the toolbar.

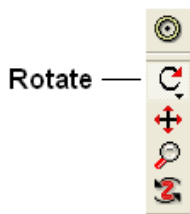

- Click and drag on your structure in the display window until it is in the desired position.

### 4.9.2 Custom Rotation

An option is provided to customize the rotation of the molecule. This allows exact rotation by a specified number of degrees.

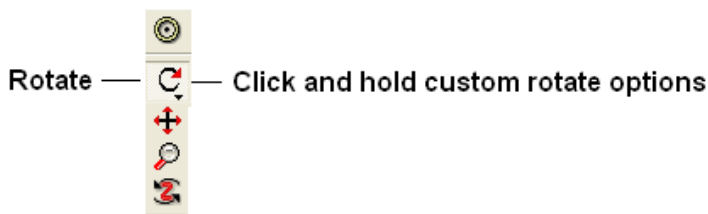

- Click and hold down the rotation button and a data entry box as shown below will be displayed.
- Enter the number of degrees of rotation you require and in which X, Y or Z coordinate.

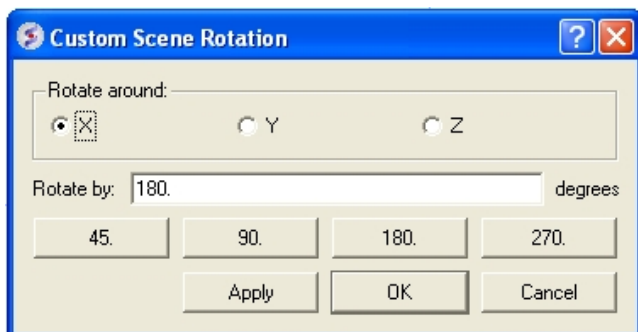

#### *To continuously rotate the picture:*

- Click on the **continuous rotation** icon on the toolbar.
- Click, hold, and slightly move your mouse anywhere on the graphical display window. The point at which you hold your mouse, is the direction to which the object will turn.
- Positioning the mouse towards the center of the display will move the object slower than if the mouse is positioned towards the edge of the graphical display.

In order to rotate your picture around the Z-axis:

- Click on the **Z-axis rotation** icon on the toolbar.

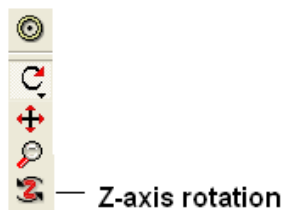

- Click and drag your object around the Z-axis until it is in the desired position.

### 4.9.3 Translation

To translate your structure up, down, left, or right:

- Click on the **translation** icon on the toolbar.



- Click and drag on your structure in the display window until it is in the desired position.

When you are displaying more than one object and you wish to translate one object in relation to the other on the Z-axis:

- Right click on the name of the object you wish to move in the ICM workspace and select connect to object. This object is now independent from the other object and can now be manipulated separately.
- Click on the **Z translate** icon on the toolbar.
- Click and drag your structure along the Z-axis, moving it closer or further from your unconnected structure.
- Once you are finished, right click on the name of the object which is connected, and click on disconnect.

#### 4.9.4 Zoom

*To zoom in or out of your structure:*

- Click on the **zoom** icon on the toolbar.



- Click and drag your mouse up to zoom in and down to zoom out.

You can also zoom in and out directly with the right-mouse-button *without* explicitly switching to the zoom tool, if you use the **left 5%-margin** of the graphics window.

#### 4.9.5 Center

*To restore your picture to the center of the graphical display window or to center on a selection:*

- Make a selection of the region you wish to zoom into – if no selection is made the whole structure will be centered.
- Click on the **center** icon on the toolbar.



#### 4.9.6 Torsion Angles

*To alter the torsion angle of certain residues of your structure:*

- Convert your pdb structure into an ICM object.
- Click on the **change torsion angles** icon on the toolbar (see button key above).
- Click and drag on the atom around which you wish to rotate a residue. The changing angle will be displayed in orange.

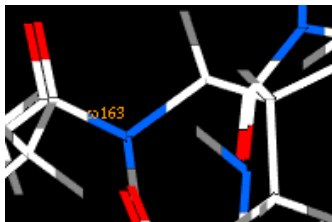

**NOTE:** This option can be used more effectively in conjunction with the `variable label` option.

## 4.9.7 Connect (Move)

When there is more than one object displayed in the graphical display window the objects are connected to one another. If you wish to move or manipulate one object independently from the others you need to **connect** to it

*To do this from the ICM Workspace:*

- Right click on the name of the object you wish to move in the ICM workspace and select **Connect to Object**. The object will now be colored yellow.

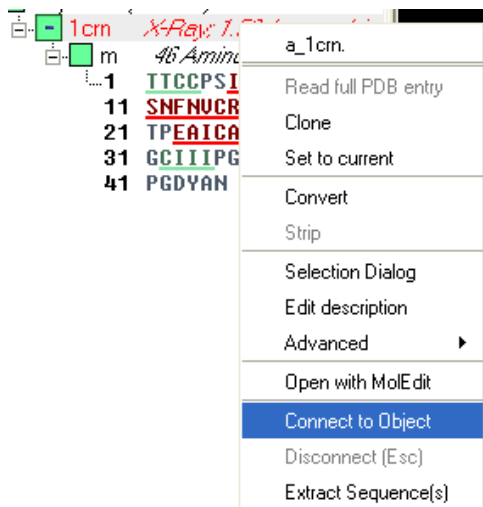

- The object is now controlled separately from the rest of your objects by your mouse.
- Disconnect your object by once again right clicking on the name of the object in the ICM Workspace and selecting disconnect in the drop down menu or **Press the ESCAPE key**.

**Note:** you can temporarily switch to the global rotation in the connected state if you press **Shift**

**Note:** use the Escape button to disconnect

## 4.10 Clipping Tools

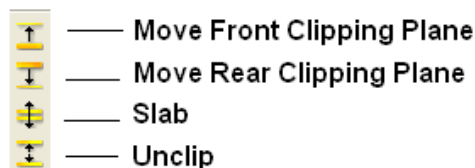

The clipping tools allow you to adjust the frames of the ICM window, changing the clipping planes.

Clipping planes can also be moved *without* switching to the clipping tool, if you click the right hand margin of the graphics window:

- The top section of the right 5% margin of the graphics window: moves the back clipping plane
- The middle section of the right 5% margin of the graphics window: moves the slab (both clipping planes)
- The bottom section of the right 5% margin of the graphics window: moves the front clipping plane

In order to move the front or rear clipping planes of your screen:

- Click on the **Move front clipping plane** or **Move rear clipping plane** icons on the toolbar.
- Click and drag the respective plane forward or backward, depending on how you wish to clip it.

You can also move the **slab** of viewing window, keeping the distance between the front and back clipping planes. In order to adjust the area of the structure where your viewing window is located:

- Click on the **Slab** icon on the toolbar.
- Click and drag the slab forward or backward, depending on the desired area of the structure you wish to see.

If you have made changes to the clipping planes which you do not wish to keep or you wish to automatically fit your entire structure within the clipping planes:

- Click on the **Unclip** icon on the toolbar. This will automatically set the clipping planes to fit your object.

### 4.10.1 Mesh Clipping

Clipping tools can be used to adjust the frames of the mesh independently of other objects.

The buttons shown below can be used for this purpose.

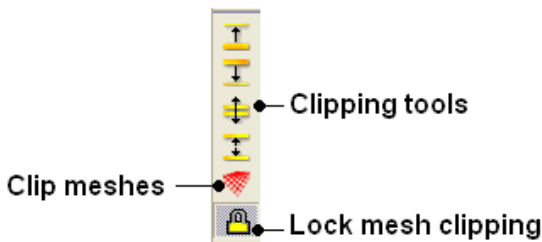

The buttons used for clipping are described in the section entitled *Clipping Tools*.

### 4.11 Graphic Layers

To display and undisplay layers of a structure you can use the buttons shown below. Seven layers can be created and within each layer different structural representations can be displayed.



Right click on one of the layer buttons and a number of options can be chosen as shown below.



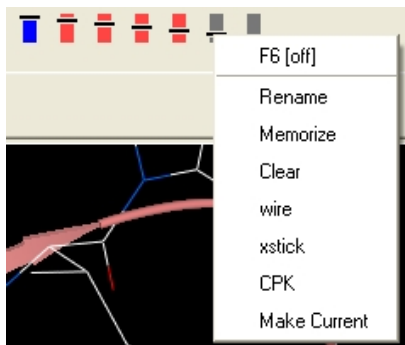

To change the display in one of the layers:

- Right click on one of the layer buttons.
- Select a representation wire, xstick or CPK.
- You can do this for each of the seven layer buttons.
- Click on the layer button to display and undisplay. If the layer button is shaded red then the layer is not displayed. If the layer button is shaded light blue then it is displayed. You can switch between layers by clicking on the button or using the **memorize** button to store a particular representation and **clear** to remove a memorized representation.

## 4.12 Make High Quality Publication Images

### 4.12.1 Write Image

To make high quality publication images:

- File/Write Image

This is described in more detail [here](#).

Or, use the button at the bottom of the graphical user interface (see images below).

### 4.12.2 How to Save an Image to the Clipboard

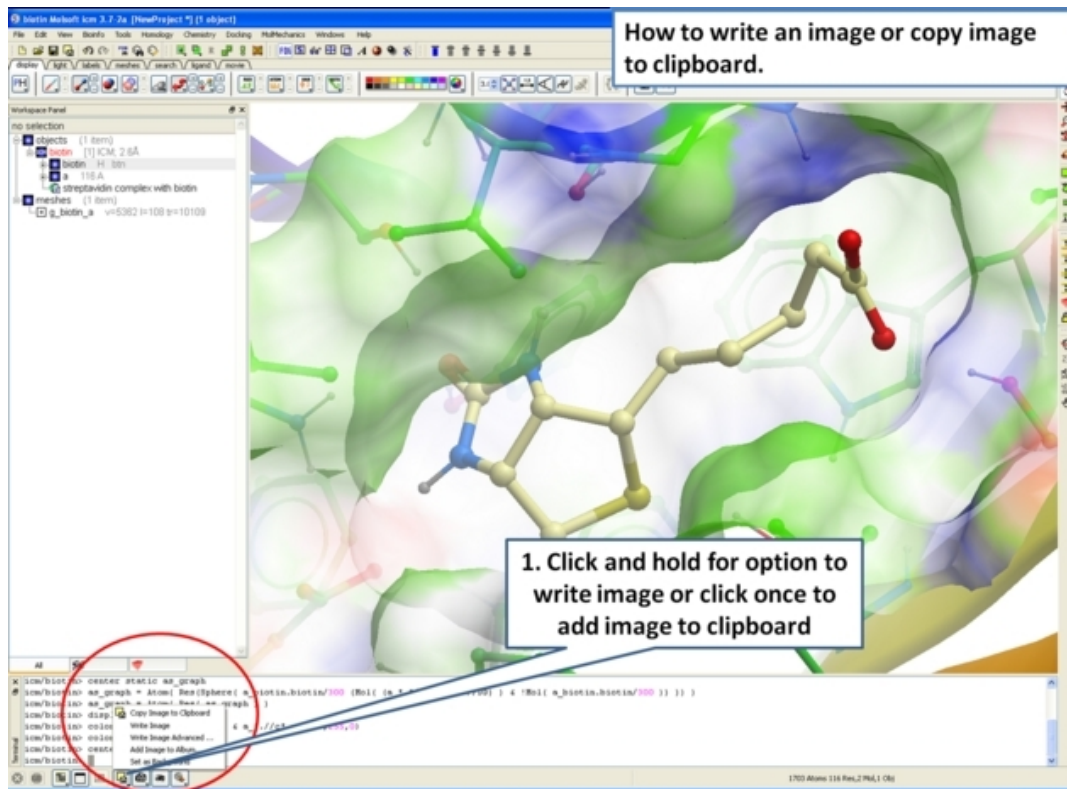

### 4.12.3 Advanced Image Options.

Click and hold the button shown below for options for resizing, transparent background, and storing an image in ICM.

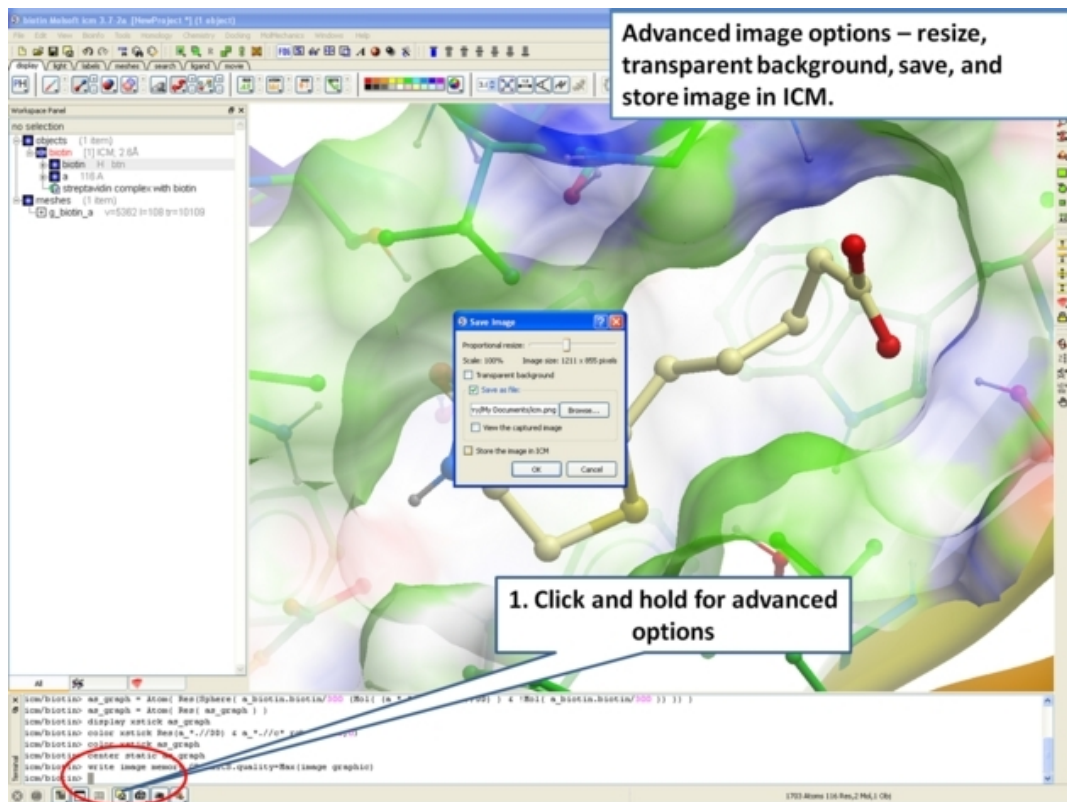

## 4.12.4 Add Image to Album

If you are making an ICM document you may want to store images inside ICM.

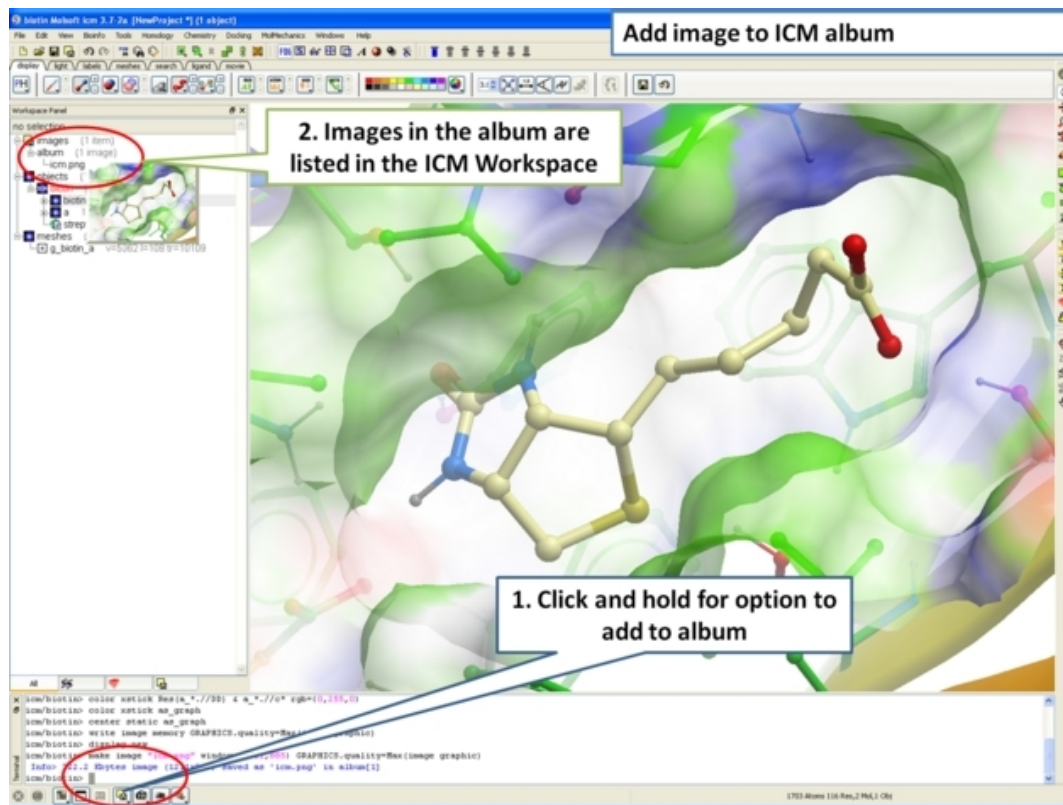



# 5 Molecular Animations, Slides, and Documents

**Note:** Click **Next** (top right hand corner) to navigate through this chapter or use the links below. Headings are listed on the left hand side (web version) or by clicking the **Contents** button on the left-hand-side of the help window in the graphical user interface.

In this chapter you will find a description of the tools available to create files (.icb) containing fully-interactive three-dimensional (3D) molecules and two-dimensional (2D) data. These files can contain multiple interactive views and animations of molecular structures and objects in conjunction with related hyperlinked text, chemical, biological sequence, alignment and data views. The files are small and easily transferable and downloadable. The files can be used for Molecular Presentation and Documents inside the ICM browser or displayed on the web and in PowerPoint using the ActiveICM plugin.

**Structural Description**

**Overall structure:** The amino-terminal lobe of CLK1 has a secondary structure typical for kinases which usually comprising three  $\beta$ -sheets followed by helix  $\alpha$  C and two  $\beta$ -sheets. The most striking feature observed in the C-terminal lobe is an **insertion between the sheets  $\beta 7$  and  $\beta 10$**  (residues S299-D317 in CLK1). This insertion is conserved within the CLK family but has however only low sequence homology when compared with other CLK family members. The insertion forms a  $\beta$ -hairpin structure ( $\beta 8$  and  $\beta 9$ ) that packs against a groove formed by helix  $\alpha D$  and  $\alpha E$ .

(TIP 1: surface grid representation coloured according to the electrostatic potentials can be turned **[ON]** or **[OFF]** for any of the viewpoints)

**Multi\_Seq\_Align**

```
1n7_q_a 35  WCARFRTITLGRHUKKLSPPFQSIIH---AKRTVLEALKWHNHHVIGLDDFT
1bnk_a 35  WCARFRTITLGRHUKKLSPPFQSIIH---AKRTVLEALKWHNHHVIGLDDFT
1ol7_a 21  WYLRKQKSKF ILALKK---FKQLKKAQEMQLRQVEIQSLRHPHILRLVGYFH
CLK1_HUMAN 175 WECIDHKAGGRHUUKLUKNVDRYCEARR---SEIQLEHLNITTPNSTRFCQD
c1k1a_a 30  WECIDHKAGGRHUUKLUKNVDRYCEARR---SEIQLEHLNITTPNSTRFCQD
CLK1_MOUSE 174 WECIDHKAGGRHUUKLUKNVDRYCEARR---SEIQLEHLNITTPNSTRFCQD
```

**Chemical**

Substructure search: Found 1 hits of "\*" in "SGCCCompounds.K (509 compounds)". Search took 0.00

Name	Value
1 MolWeight	323.00
2 HBA	3
3 HBD	5
4 /RotB	0

For examples of ICM Molecular Documents please see MolSoft's ActiveICM product page at [www.molsoft.com/activeicm.html](http://www.molsoft.com/activeicm.html)

## 5.1 Molecular Animations and Transitions

Learn how to build fully interactive and interruptable animations.



Smooth Animated Transitions

### 5.1.1 Make Animation

To quickly produce an ICM Molecular Animation:

- Click and hold down the "Begin rocking/rotation" button shown in the picture below.
- Choose from the following options – X–Rock, Y–Rock, Xy–Rock, xY–Rock, X–Rotate, and Y–Rotate.



**NOTE:** Default rocking representation can be changed in the File/Preferences/Gui menu.

### 5.1.2 Change Speed, Range and Cycle Length of Animation

To change the speed, range and cycle length of the animation:

- Click and hold down the "Begin rocking/rotation" button shown in the picture above.
- Choose the set speed range option and change the speed and range using the drag bars. Any change will appear in the graphical display behind this box.
- If desired you can change the number of cycles of the animation. This is an ideal tool for screen-shot movie making.

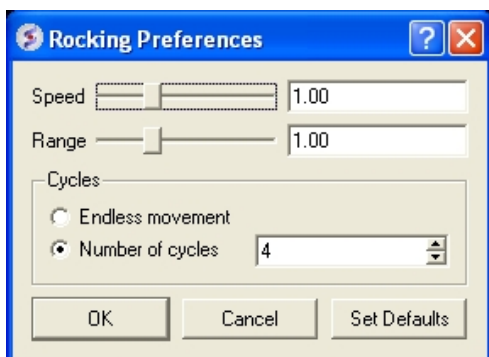

**NOTE:** There is a return to default button in the Rocking Preferences dialog box shown above and default values can be changed in File/Preferences/Gui.

**NOTE:** Default rocking speed can be changed in the File/Preferences/Gui menu.

### 5.1.3 Interrupt Animation

An ICM Animation or Transition is fully interactive and is interrupted by a single click of the mouse.

To stop or change an animation or transition:

- Click the "Begin rocking/rotation" button shown in the picture below.

To temporarily halt an animation or transition:

- Click in the graphical display. Once you release the mouse button the animation will start again.

**NOTE:** If you click on the graphical display during an animation the animation will be interrupted. Whilst clicking and holding the mouse button other operations can be performed such as zooming and selections.

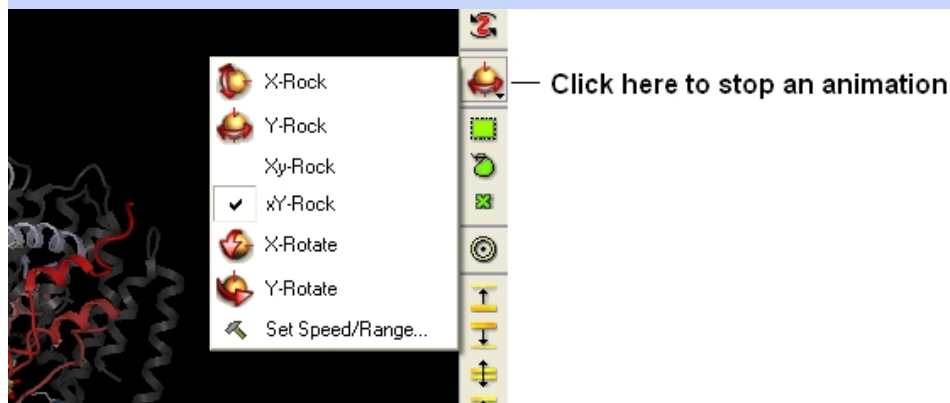

Click in the graphical display window to temporarily interrupt an animation

### 5.1.4 Saving an Animation

An animation can be saved in an ICM project:

File/Save Project

Or

as a slide.

## 5.2 Making Molecular Slides

*The following information can be stored in a slide.*

- Viewpoint
- Window layout
- Current table(s)
- Alignments
- Annotations, labels, user-defined
- HTML
- Preferences for GRAPHICS.quality, ruler style, rocking state information
- For each (mol.) object: representations and their colors, sites
- For each grob (mesh): representation and colors.

This tutorial takes you through the steps to create a series of fully interactive 3D slides. The slides can then be embedded into the web, or PowerPoint using ActiveICM or viewed in ICM-Browser (or ICM-Pro).

*To begin making ICM Molecular Slides:*

- First load the structure or structures you wish to display in your first slide. Additional structures, labels etc and text can be added at any point during the slide making process. In this example we will load the PDB file 1XWS a PIM1 kinase.

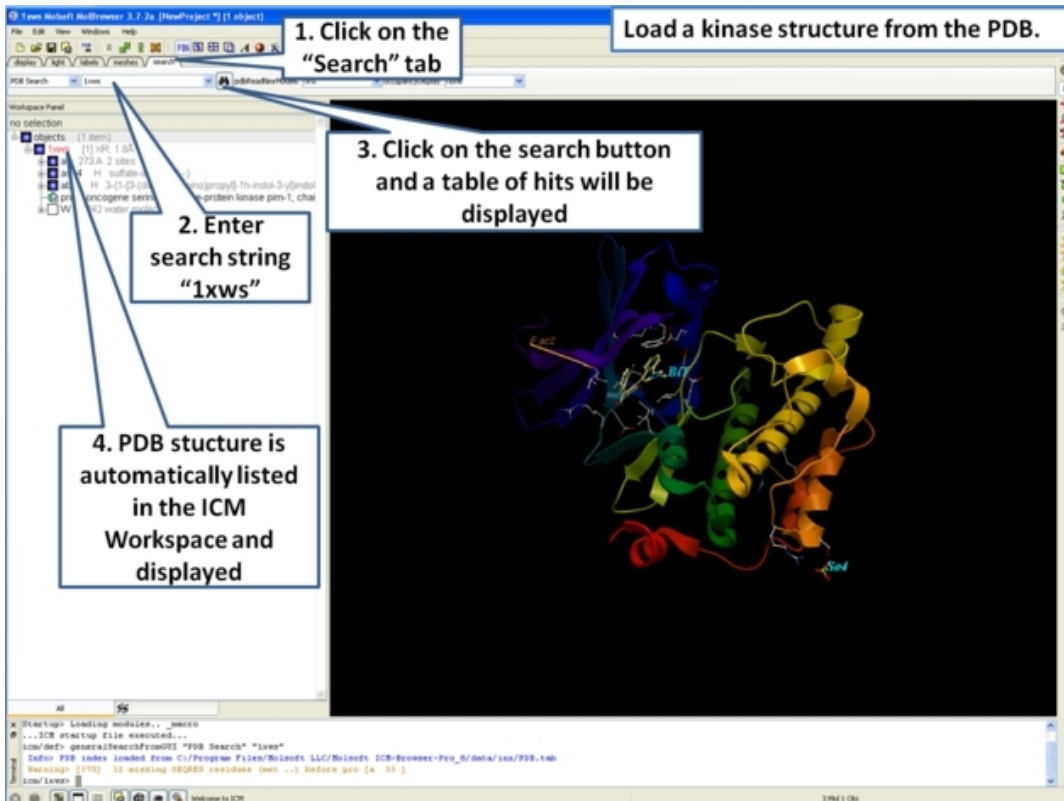

- Next, we will convert the PDB file to an ICM object so we can make slides of the ligand–receptor hydrogen bonds and binding pocket surface.

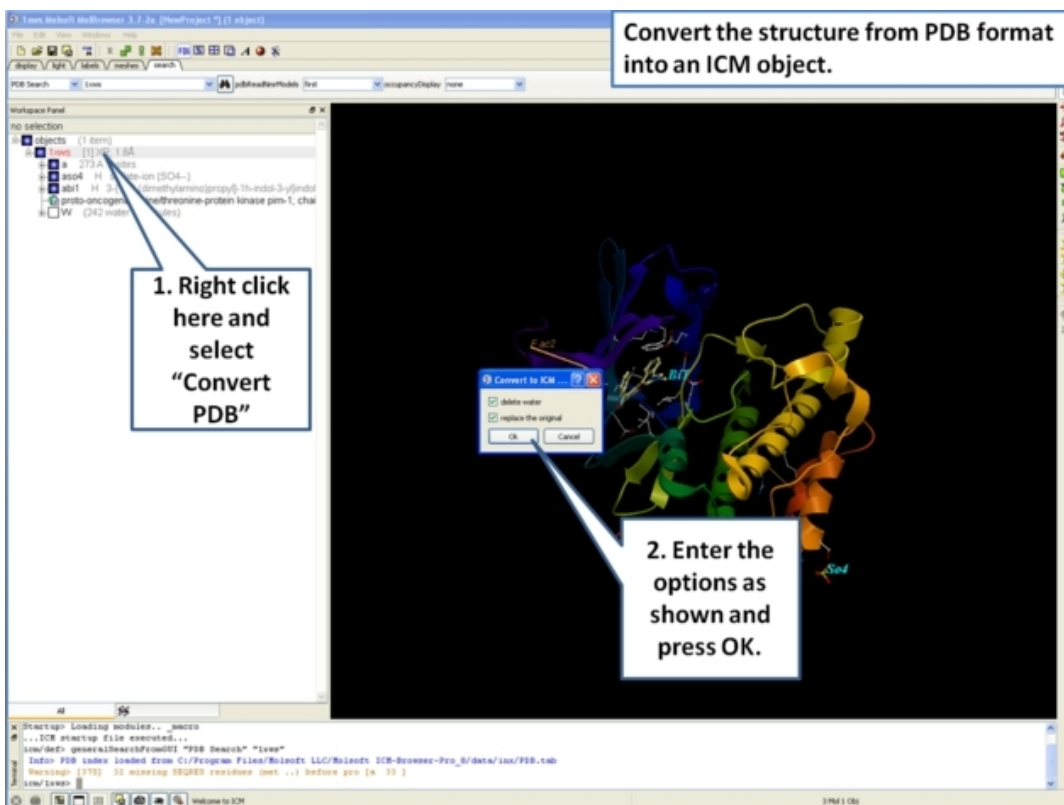

- Now we are going to prepare the first slide by rotating the protein structure to an orientation which allows the viewer to see the key features of the kinase. For example the bulge in the hinge region (between the N– and C– lobes) which is unique to PIM proteins.



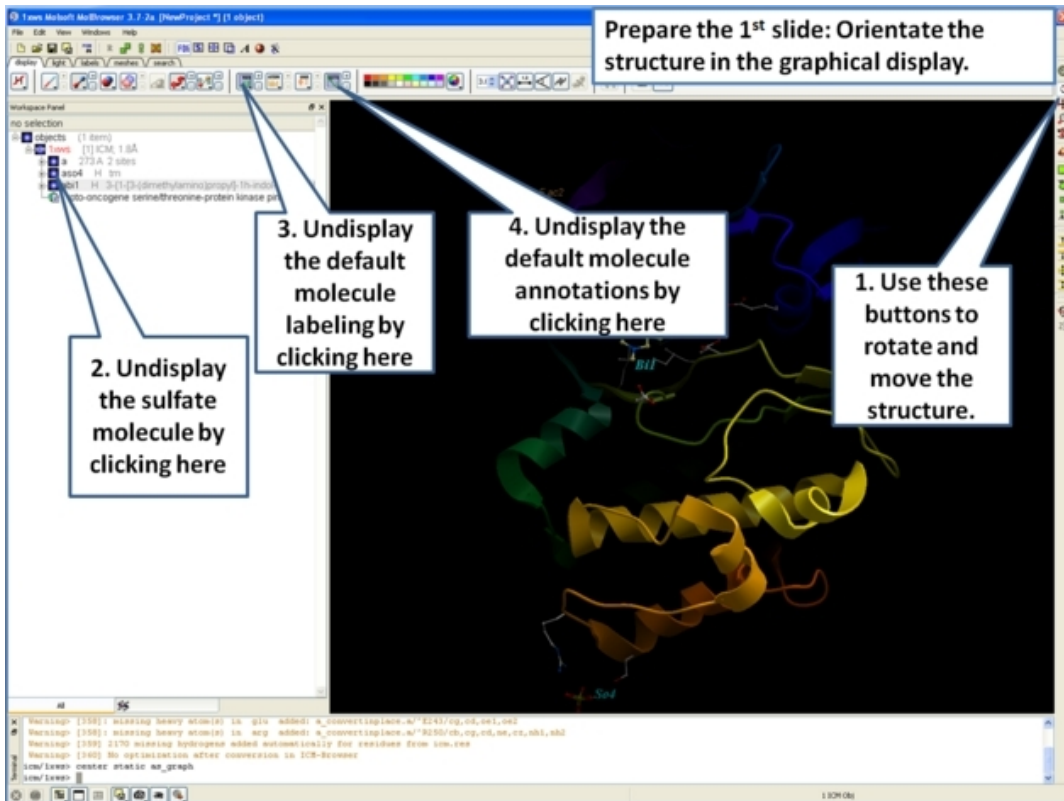

- Next, make the first slide by clicking on the camera button at the bottom of the graphical user interface.

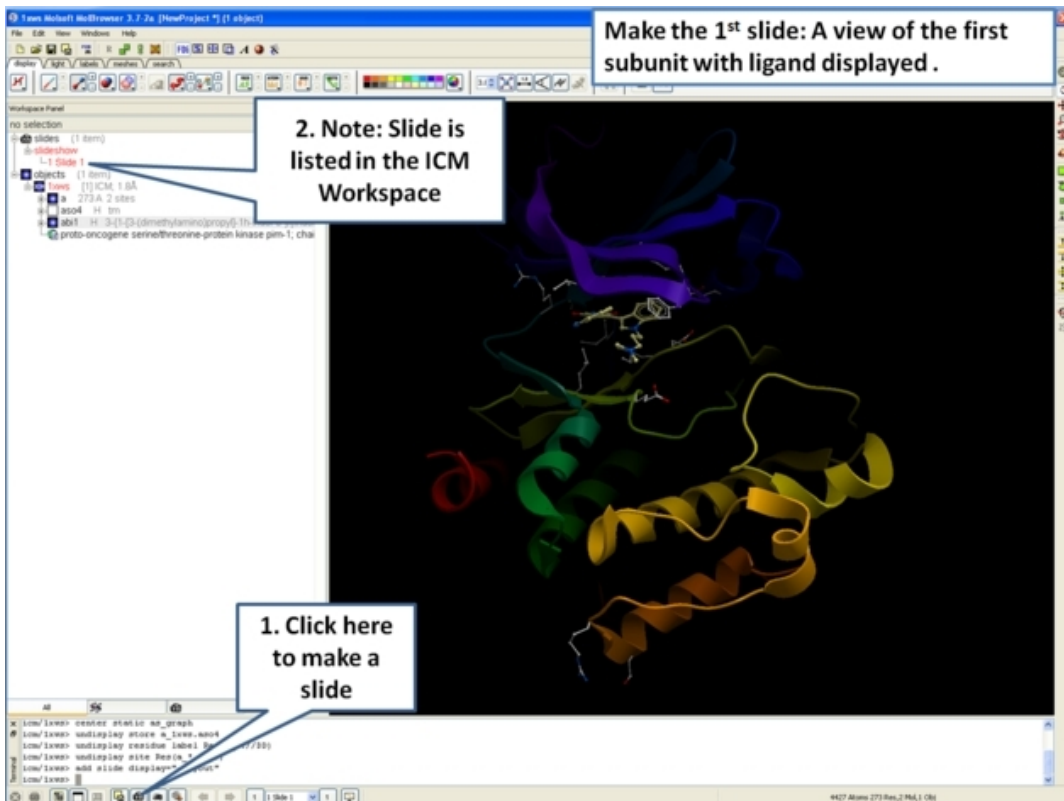



Click to add slide

- Once you have clicked on the camera button you will see that the first slide has been generated. The first slide is shown in the ICM Workspace window as shown below.

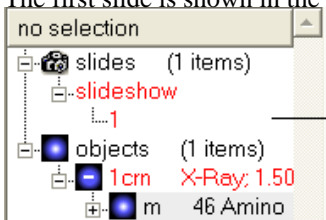

The number and name of the first slide is displayed in the ICM Workspace

- Slides can consist of Static views or Transitions and Animations. Here we will zoom into the flexible glycine rich region of the kinase which lays across the roof of the ATP-binding pocket. Click on the camera button and make the second slide

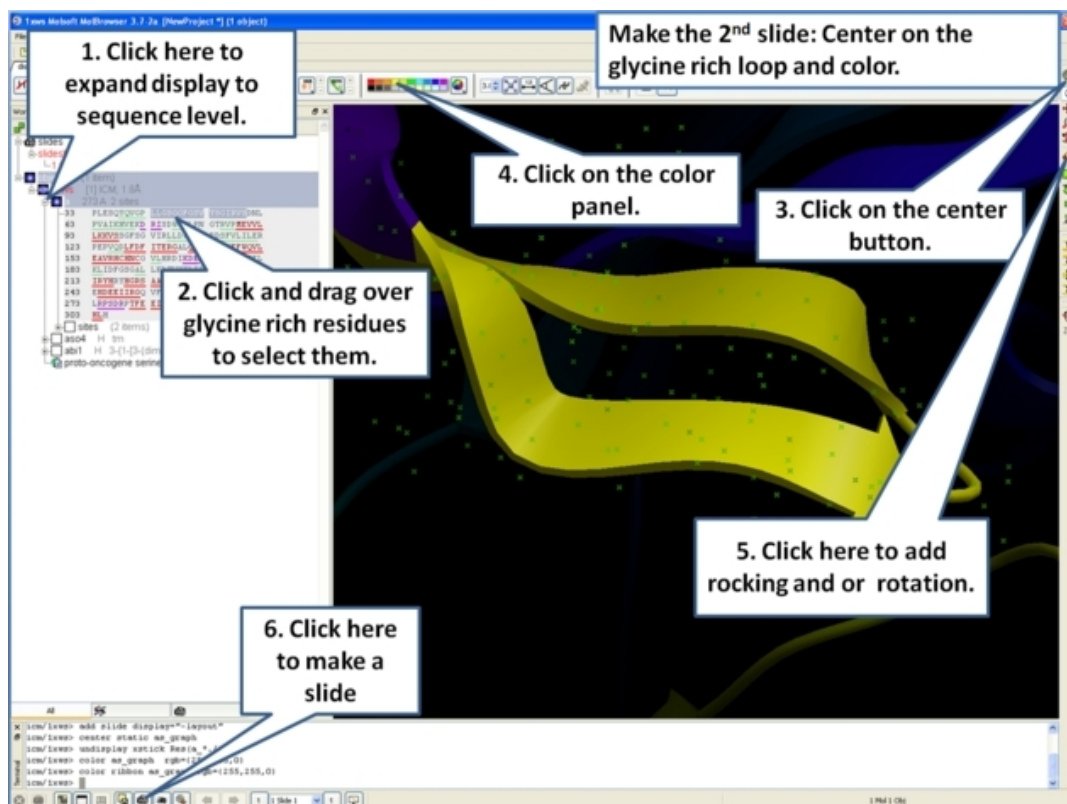

- Next, we will make a slide of the surface of the ligand binding pocket colored by binding property.

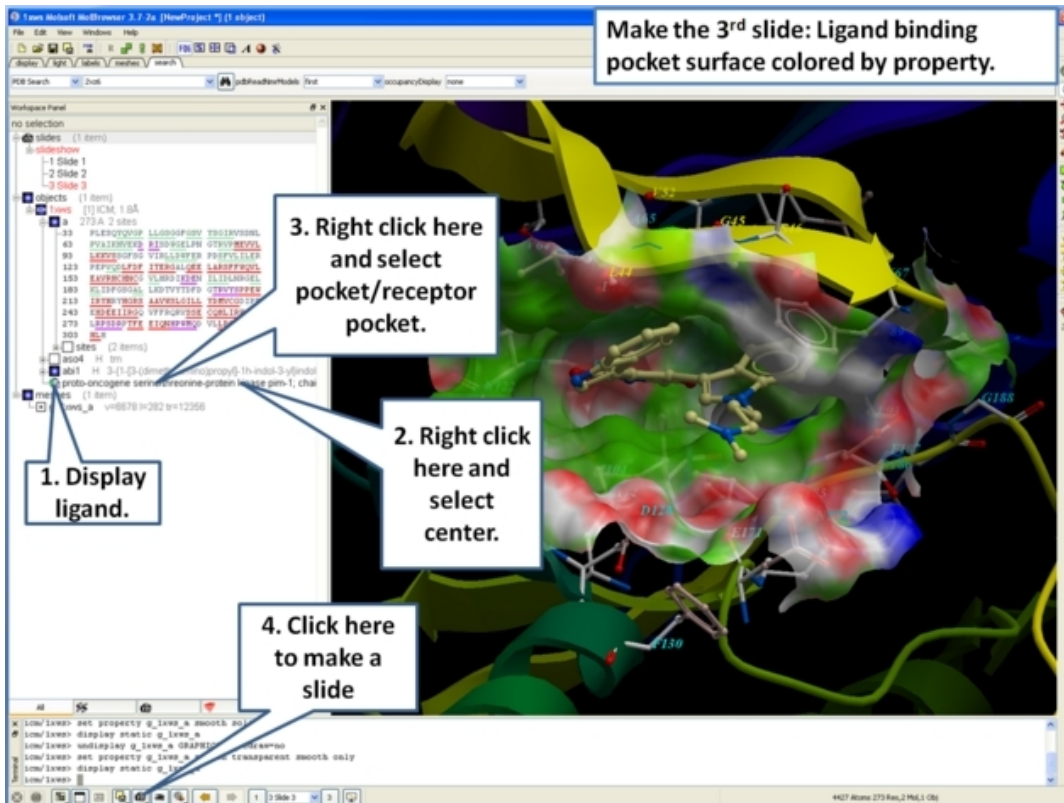

- Now save the document as an icb file. Go to File/Save as...

## 5.3 How to View and Navigate Slides

### 5.3.1 View Slide Show

To view a slide show select the buttons shown below:

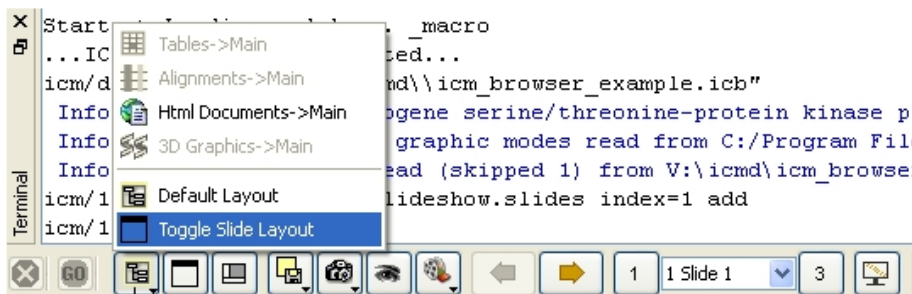

Click and hold and select Toggle Slide Layout

Run Slideshow

**NOTE:** Slides are associated with the objects currently loaded into ICM. Therefore if you delete an object then the slides will not work. However if you delete an object and then re-read the same object with the same name and structure the slides will be ok.

*To save a slide show*

- File/Save Project

### 5.3.2 Slide Navigation

You can make as many slides as you wish as described in the Making Molecular Slides section.

To navigate through the slides you can use the buttons shown below, the cursor keys for some operations or the right click options in the ICM Workspace.

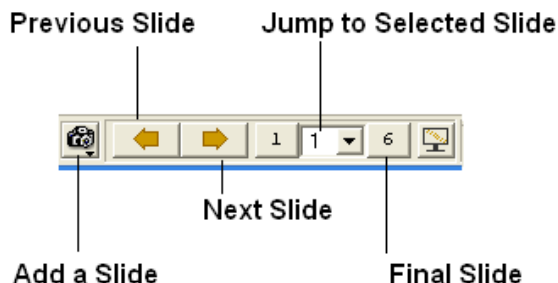

The slide currently displayed is highlighted in red in the ICM Workspace.

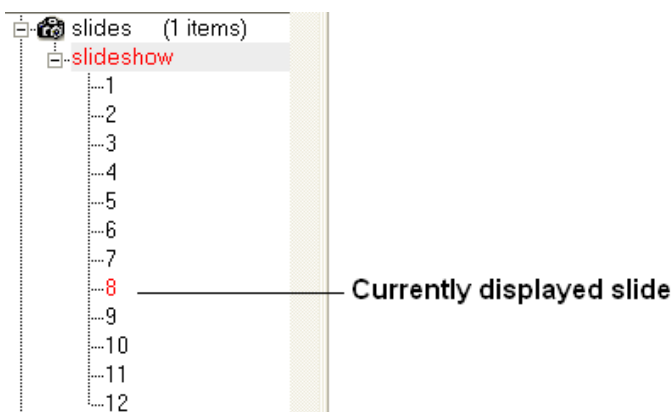

To jump to another slide right click and select "Set Slide".

All slides are displayed in the ICM Workspace. You can hover the mouse over a slide name in the ICM Workspace and a thumbnail sketch of the slide is displayed as shown below. This can be used for slide navigation purposes.



Or you can right click on the name of the slide in the ICM Workspace and select the option "Preview".

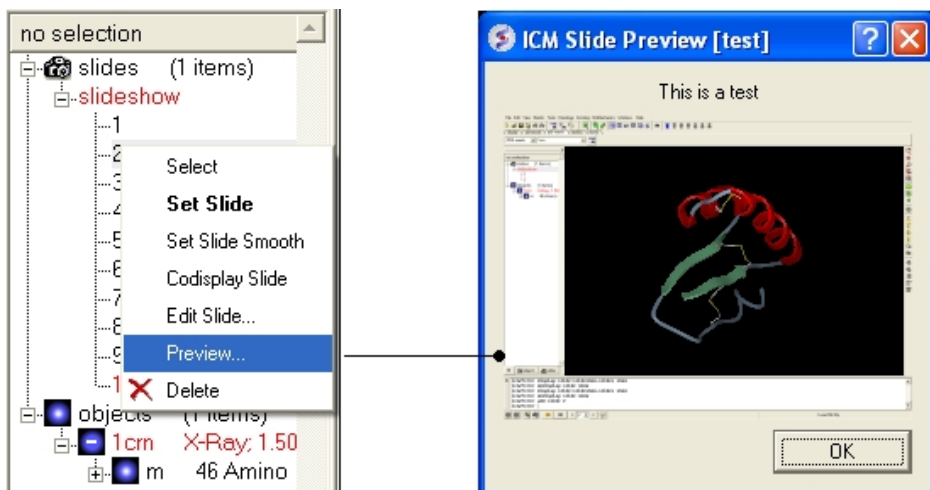

## 5.4 How to Edit Slides

You can jump to the slide you wish to edit by following the slide navigation instructions.

### 5.4.1 Edit Slide

**Edit slide contents:** To edit the content of a slide the procedure is to add a new slide and then delete the old one or use the "overwrite current slide" option as shown below:

- Click and hold down on the camera button.



Click and hold

**To edit a slide description.**

- Click and hold down on the camera button and select the option "Edit Slide Description".

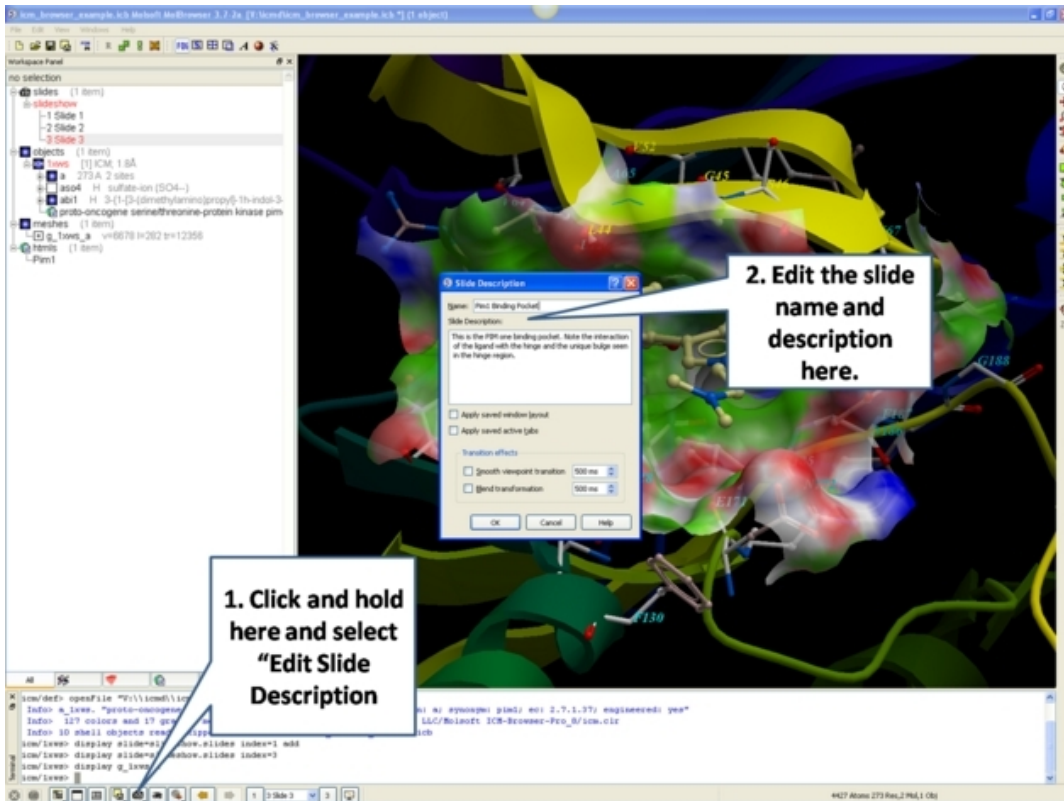

- Enter the name of the slide
- Enter a description of the slide.
- If you wish to keep the current window layout or active tabs check the boxes provided

**To delete a slide:**

- Right click on the name of the slide in the ICM Workspace and select Delete.

**To change the name of a slide**

- Right click on the name of the slide in the ICM Workspace and select Edit Slide.

**5.4.2 Move Slide**

To change the slide's position in the slideshow use the Move Current Slide option and select the new position from the list.

- Click and hold on the "make slide button".
- Select Move Current Slide.

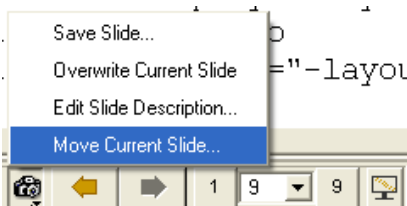

Click and hold

- Select the position in the slide show where you want to move the slide to.

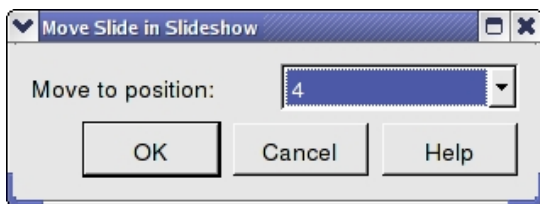

### Co–display more than one slide

- Right click on the name of the slide in the ICM Workspace you wish to co–display with the currently displayed slide.
- Select the option co–display slide.

## 5.5 How to Add Smooth Blending and Transition Effects Between Slides

### How to add smooth and blend transitions to a slide.

- Right click on the name of the slide in the ICM Workspace.
- Select **Edit Slide**.
- Select the desired transition effect – **smooth** or **blend** as shown below.
- Select the length of the transition in milli seconds.

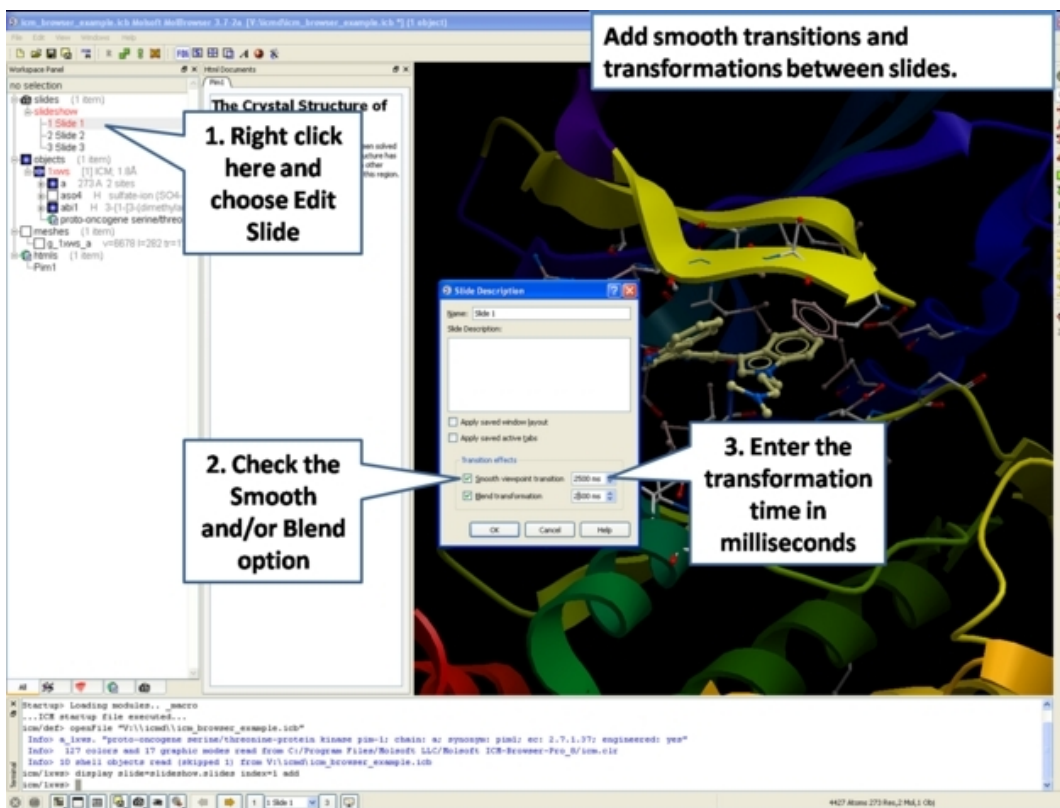

## 5.6 How to Make Molecular Documents – Link HTML Text to Slides

An ICM Molecular Document contains text and images which can be hyperlinked to the graphical display. Click on the hyperlinked text and then a fully–interactive 3D slide will be displayed. The hyperlinks are usually linked to a set of slides but can also be linked to a series of commands in a script, a web page, a table or alignment. Once a molecular document has been made you can view it in the ICM–Browser (File/Save Project .icb file) or download ActiveICM and view it in a web page or Powerpoint.

## To begin creating an ICM document

- File/New/ and click on the HTML tab.
- Enter some text. E.g the Name of the HTML document. Formatting can be changed as described in the edit section below.
- Click OK

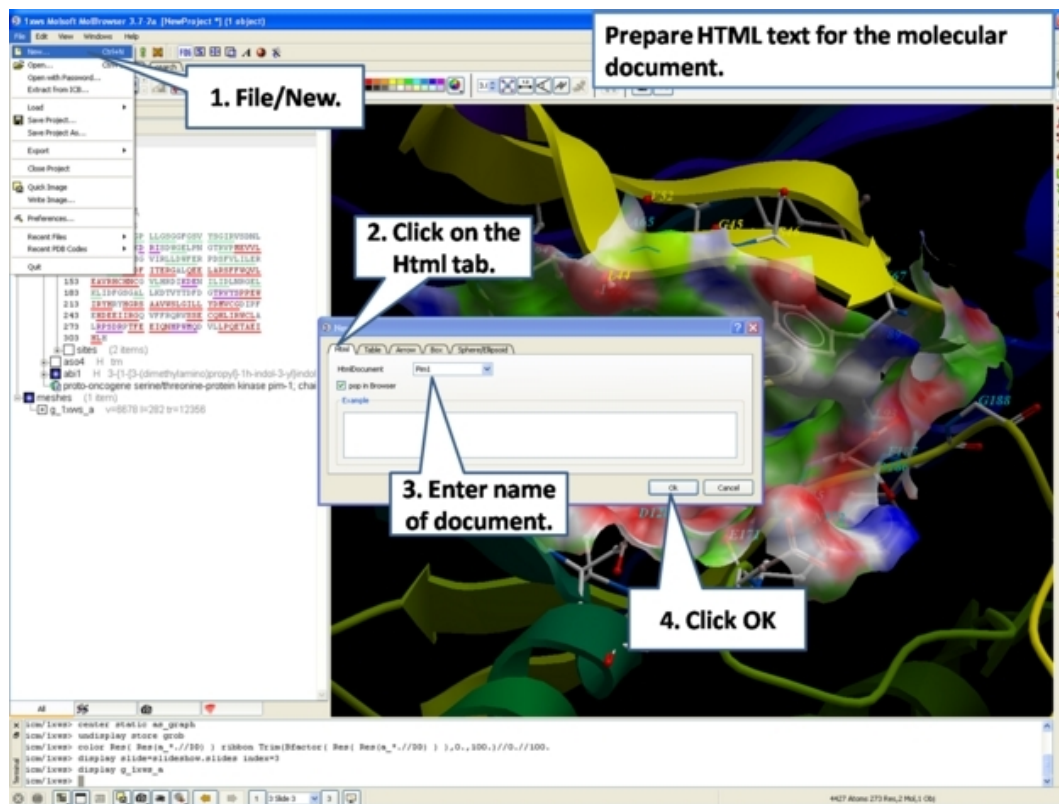

- A HTML text panel will be displayed in the graphical user interface.

**NOTE:** You can add multiple documents into a single file. The documents will be accessible via tabs at the top of the HTML panel.

### 5.6.1 How to Add Text or Edit a Molecular Document

#### To edit the HTML text in the graphical display

- First create an HTML document and the text panel will be displayed in the graphical user interface.
- Right click in the body of the text display panel and select **Edit**.



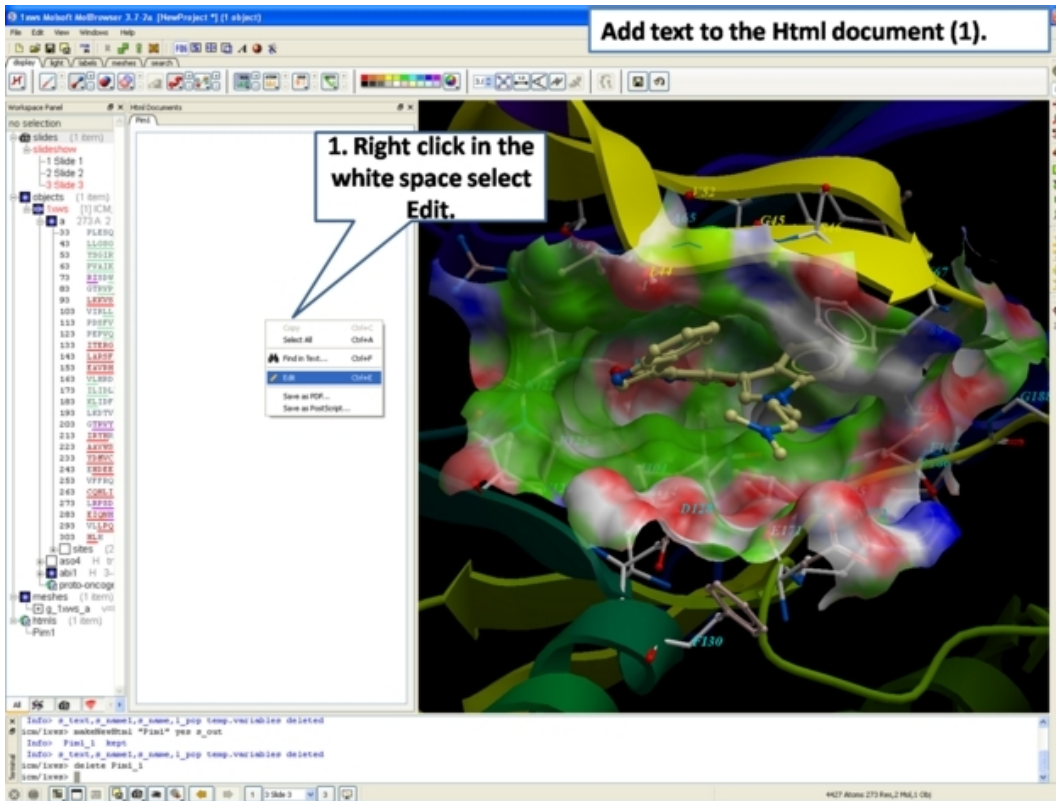

- Enter text and use the formatting tools provided in the panel above the text editor. Make sure you have selected the **Edit** tab in the HTML editor. You can see your page in the **View** tab or write directly in HTML in the **Source** tab.

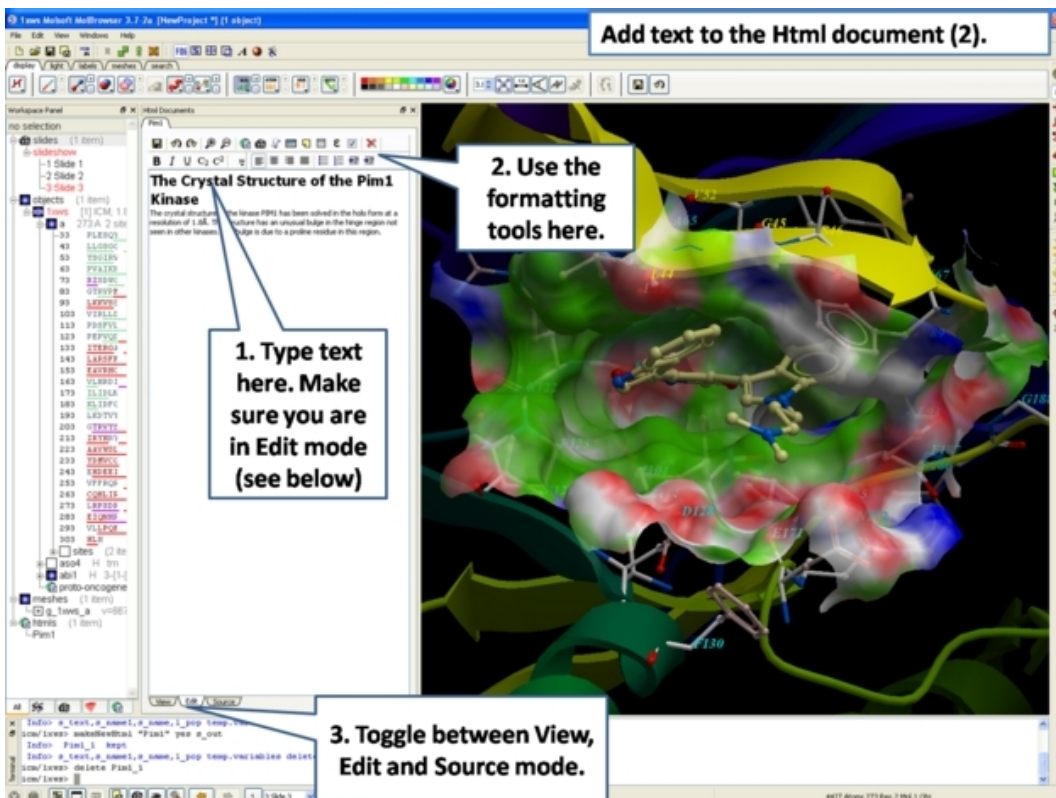

The key formatting tools in the HTML editor are shown below.

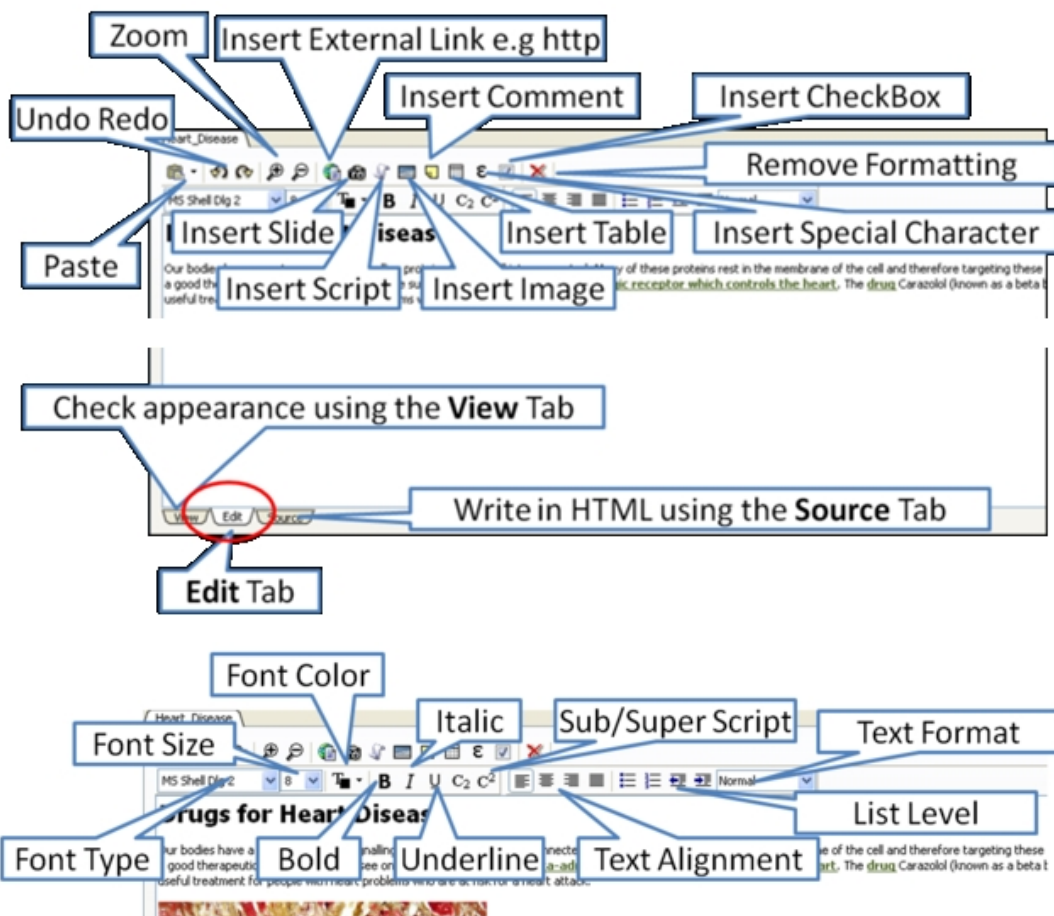

## 5.6.2 How to Make a Hyperlink Between Text and a Slide

*To make a hyperlink between the text and the graphical display (slide)*

Make a slide or set of slides of the graphical display you wish to link to. See Making Molecular Slides for help on this. Once slides have been created:

- File/New/Html
- Right click in the body of the text display panel.
- Select Edit.
- Highlight the text you wish to link to a graphical display – you can do this by left clicking and dragging over the text (selected text will be highlighted in blue).
- Click on the "Camera button" in the HTML editor formatting tool panel.
- Select the **Slide** tab.
- Select which number slide you wish the text to be linked to from the drop down menu.
- There is an option to display the slide as a thumbnail image in the text document panel. Check if appropriate.

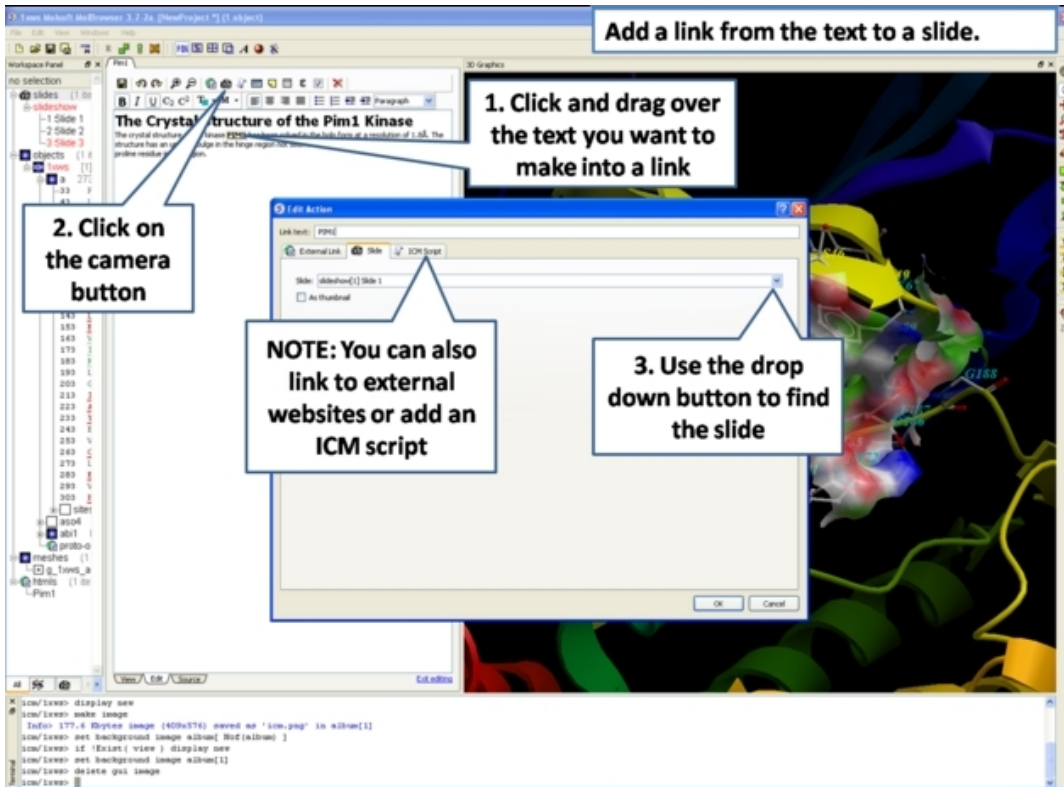

### 5.6.3 Insert Image

**NOTE:** The easiest way to add images (PNG or JPEG) into an ICM Document is to use drag and drop. You can drag and drop the image into the ICM Workspace or go to File/Open. Once the image is in the album in the ICM Workspace you can then drag it from the ICM workspace into the HTML editor.

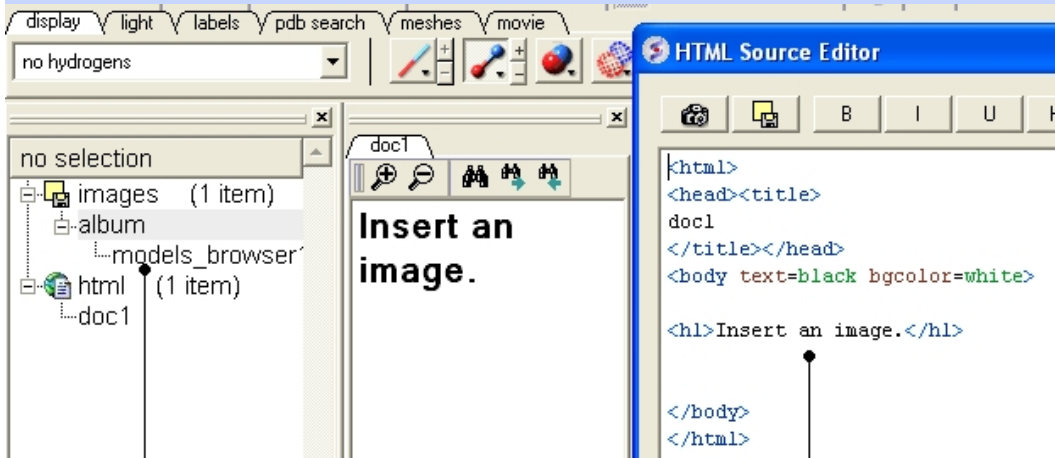

Drag and Drop from the ICM Workspace to the HTML source editor

*Another way to insert a picture into the HTML text panel*

- First read the image into the ICM photo album File/Open OR Drag and Drop from directory into the ICM Workspace.

The image name and preview will then be displayed in the ICM Workspace.

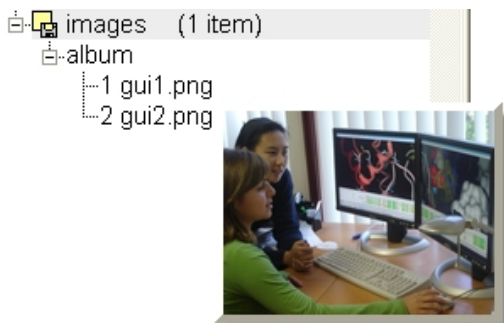

- Create HTML text – File/New/HTML. Add text.
- Right click in the HTML window and select 'Edit Source'.
- Right click on the position in the ICM Script Editor where you would like to insert the image.
- Select 'Insert Image'

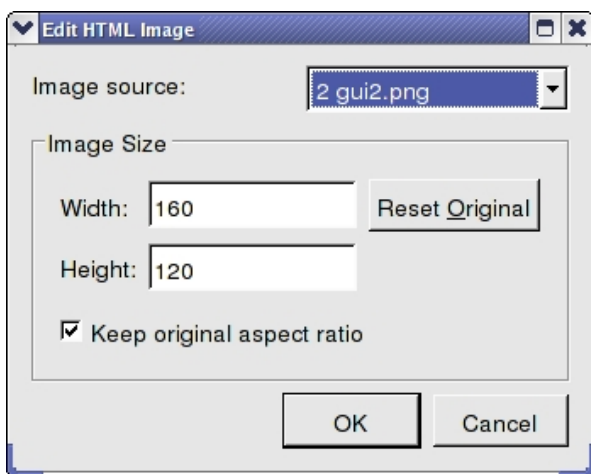

- Select the image name source.
- Choose the desired Width and Height.
- Click OK.
- Click Save in the ICM Script Editor.

## 5.6.4 Insert Script

### *How to insert a script to the text panel*

There are 3 ways to add a script – described in more detail below

1. Drag and drop script from ICM Workspace
2. In the HTML Source Editor – right click and select Insert Slide or Action
3. Create an "inline" script

These methods are described below:

### *Drag and Drop Method*

- Create a script File/New/Script
- The script will be displayed in the ICM Workspace.
- Right click in the HTML Text Panel (for instructions on how to create this panel see create molecular document) and select edit source and the HTML Source Editor will be displayed.
- Click–Drag and Drop the script into the HTML Source Editor

A line as shown below will be added.

```
<a href="#icm/script/script1">text placed here will be displayed as a link in the document</a>
```

*Another way to add a script to the document is to Insert Action:*

- Right click in the body of the text display panel.
- Select Edit Source
- Highlight the text you wish to link to a graphical display – you can do this by left clicking and dragging over the text (selected text will be highlighted in blue).
- Right click and select 'Insert Slide or Action' or select the button in the HTML Source Editor and a window as shown below will be displayed.

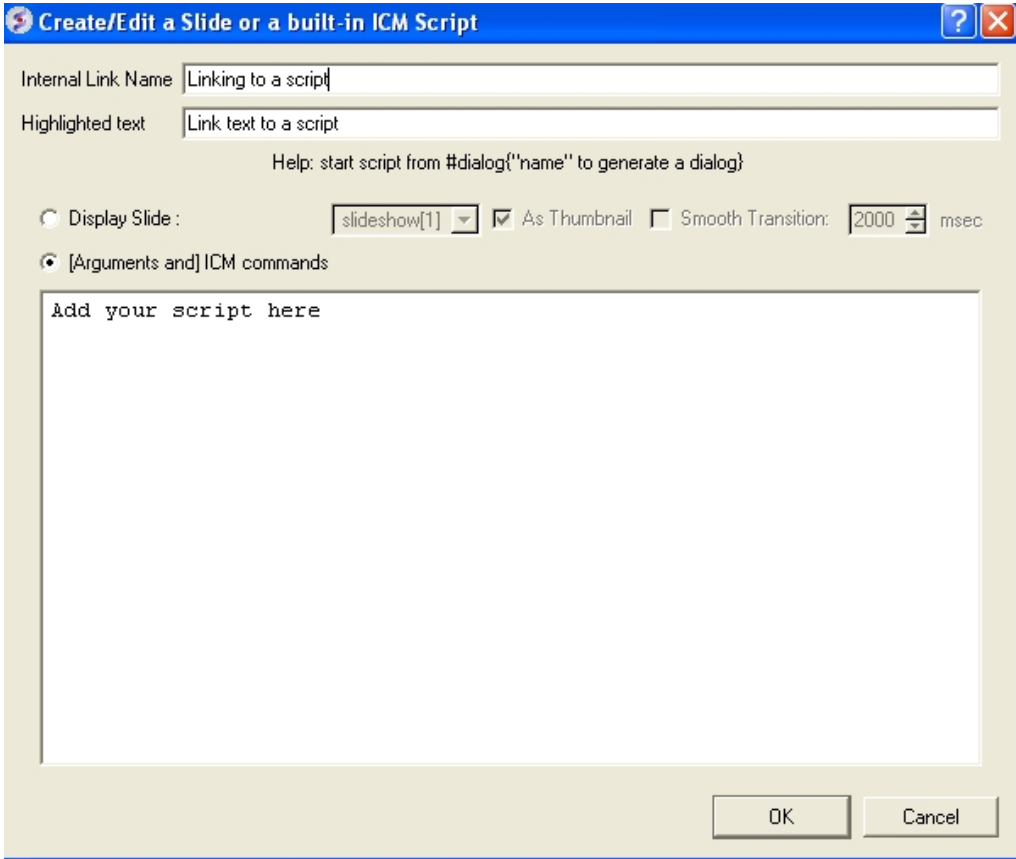

- Select the option [Arguments and] ICM commands
- Add script in the editor provided
- Select ok

### ***Inline Script***

A script can be added to the HTML text in the following way

- Right click in the body of the text display panel.
- Select Edit Source
- Enter script in the format as shown below.

```
<!--icmscript name="script2"  
print $1 + $2  
--><a name="script2" href="#_">script2</a>
```

## **5.6.5 Insert a Dialog Box**

Dialog boxes are provided to enable a viewer to interact with a presentation or document file. The dialog box will be a gui data entry box. For an example here is a script to prompt the user of the file to enter a pdb code:

```
read pdb $1
```

ds a\_1.



The code above can be saved as a script or inside the html text. To do this:

1. Right click on the HTML text display and select "Edit Source".
2. Highlight the text you wish to link to a dialog box and then select the right click and select 'Insert Slide or Action' or select the button in the HTML Source Editor and a window as shown below will be displayed.

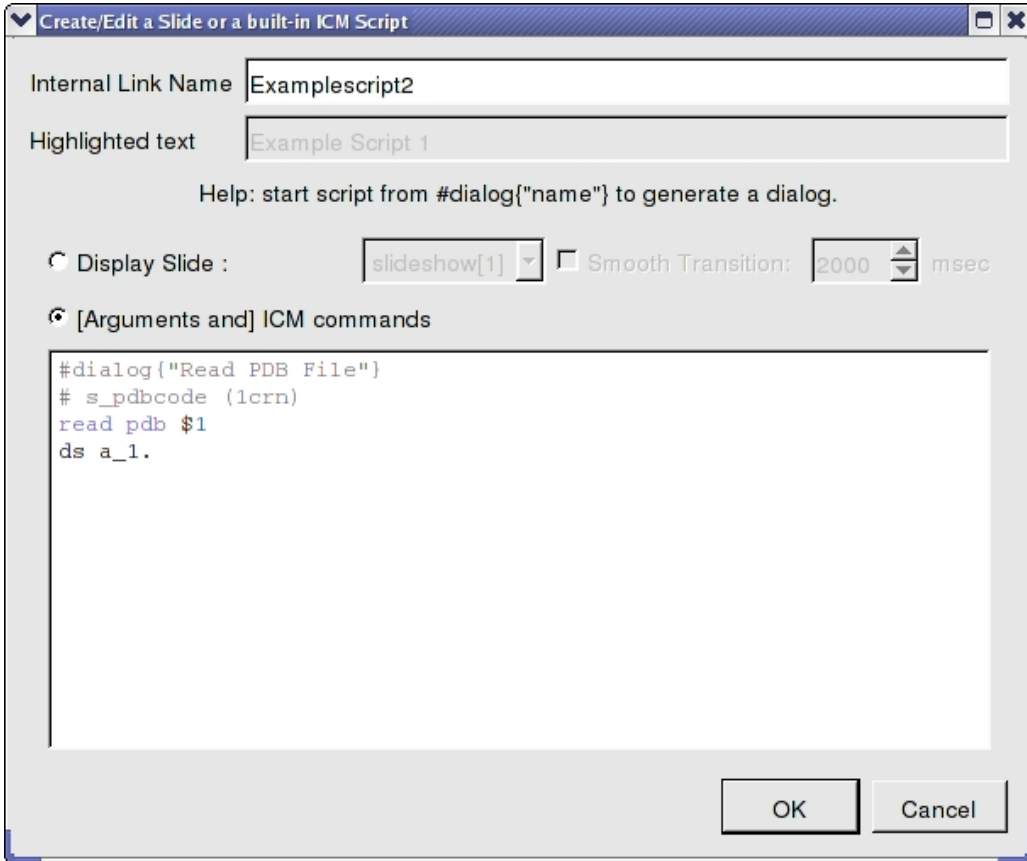

OR.

1. Right click on the HTML text display and select "Edit Source".
2. Add a link to a script as shown below.

```
<a href="#icm/script/script1">Example Script 2</a>
```

## 5.6.6 Document Navigation

The following buttons shown below aid document navigation. Also remember that more than one document can be stored and the header of each document file will be displayed in multiple tabs in the text panel window.

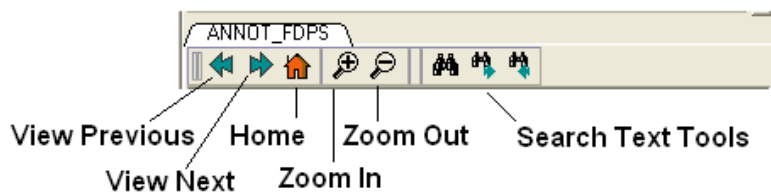

## 5.6.7 Protect Shell Objects From Deletion

When making a molecular document you can protect objects from deletion by the person who reads your document by:

- Right click on the object in the ICM Workspace.
- Select the **Protect** option.





## 6 ActiveICM

ActiveICM enables you to view and display ICM graphical slides and animations interactively inside Windows Microsoft PowerPoint and web browsers such as Internet Explorer and Mozilla Firefox.

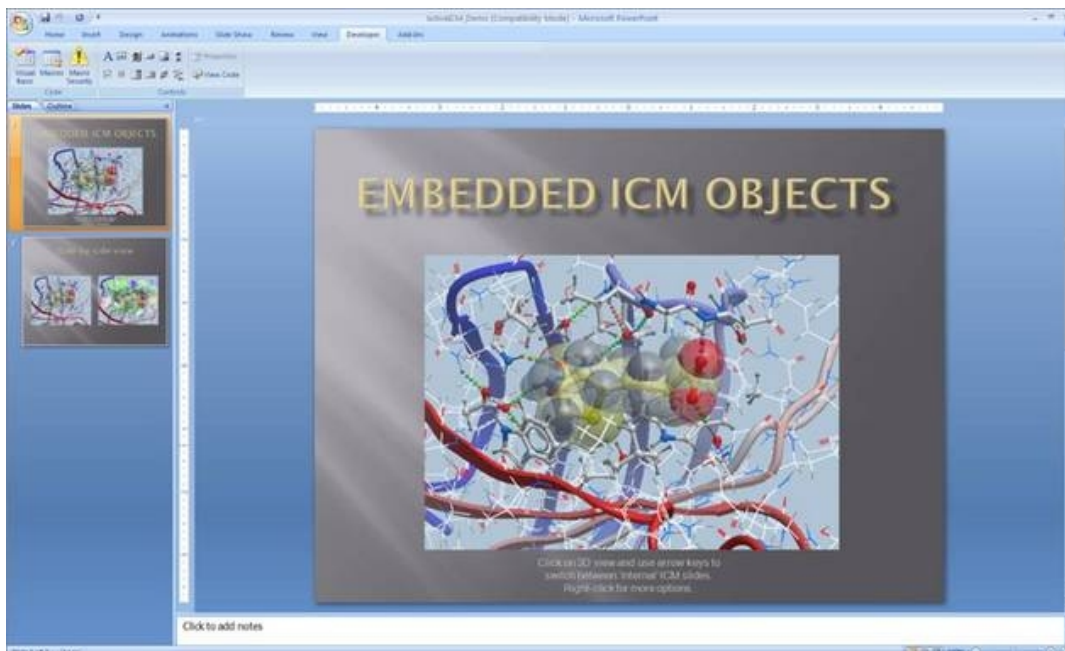

### 6.1 How to Embed in Microsoft PowerPoint 2003

#### Setup

- Download ActiveICM from [www.molsoft.com/support](http://www.molsoft.com/support)
- Save an ICM file (.icb) containing slides. Click [here](#) to see how to make slides.

#### Embed icb file

- Open the Insert menu from the top bar of PowerPoint and select **Object**
- This opens up the Object dialogue. Select **ActiveIcmCtlClass**:

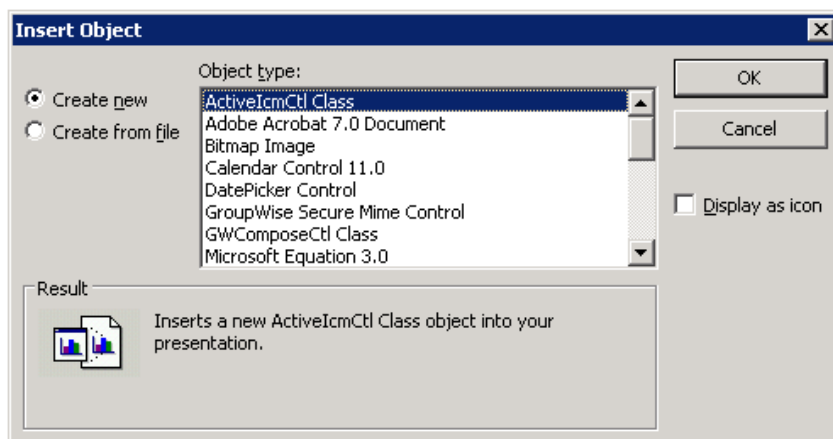

- Click on OK. A file dialogue will then be opened. Open the ICB file you wish to use via this dialogue. **IMPORTANT:** To avoid later problems, make sure the ICB file is in the same folder as the PowerPoint file.

- A low-resolution snapshot of the first slide in the ICB file will be shown in the activeICM control you created. You can change the shape of the control by dragging the corners of the control with the mouse, once selected.
- Right-click on the activeICM control and select the Properties menu item

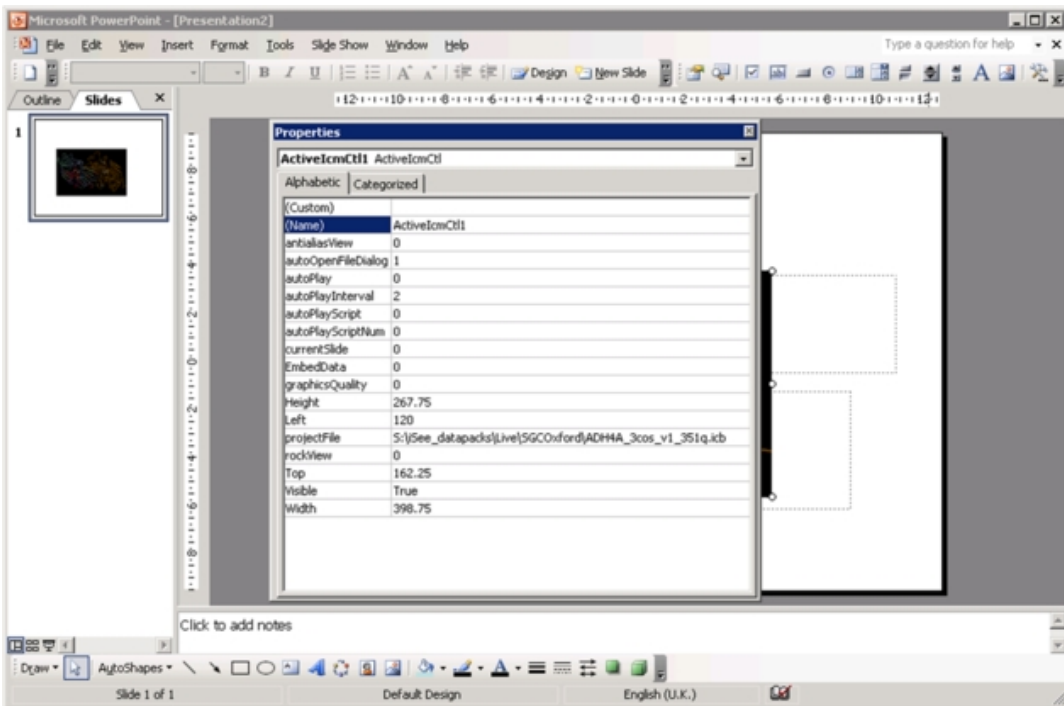

- Save the PowerPoint presentation

## 6.2 How to Embed in Microsoft PowerPoint 2007

### Setup

- Download ActiveICM from [www.molsoft.com/support](http://www.molsoft.com/support)
- Save an ICM file (.icb) containing slides. Click [here](#) to see how to make slides.

**NOTE:** Here are the instructions for ActiveICM in Microsoft Office 2007, for older versions of PowerPoint see [here](#).

### Enable the Developer Menu:

- Click the **Microsoft Office Button** (button top left), and then click **PowerPoint Options**.
- In the **PowerPoint Options** dialog box, click **Popular**.
- Under **Top options for working with PowerPoint**, select the **Show Developer** tab in the **Ribbon** check box, and then click **OK**.

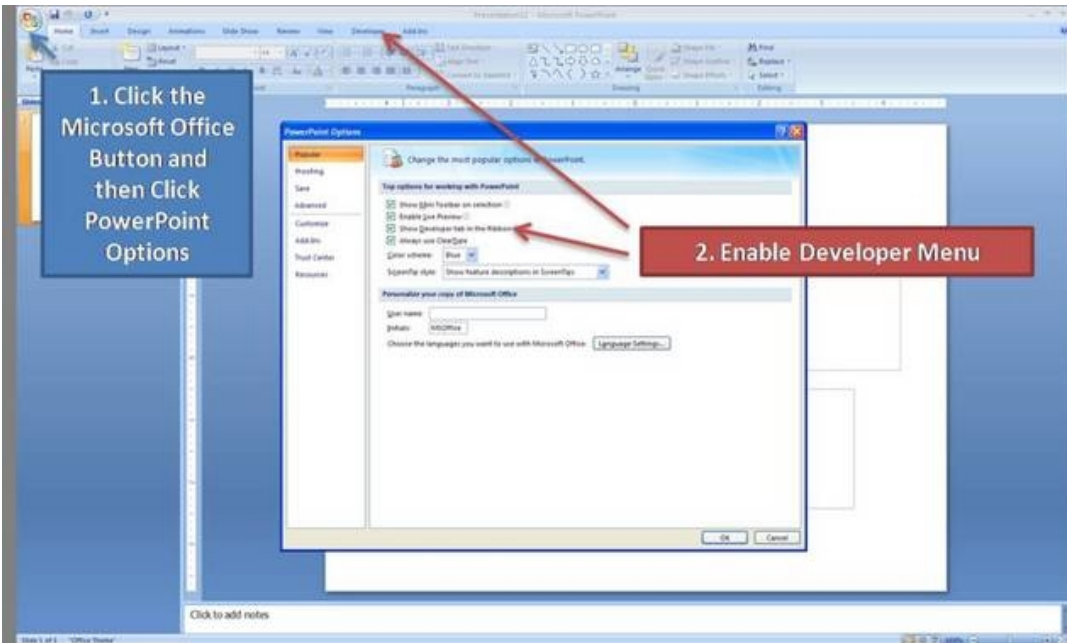

**Insert ActiveICM into PowerPoint:**

- Select the **Developer** menu.
- Select the **More Controls** button in the **Controls** field.
- Select **ActiveICMctl Class** from the list of controls and click **OK**.
- Click the mouse anywhere in the white PowerPoint space and a dialog box will be displayed asking you to select your ICM (.icb) file.
- Click and drag at the corners of the image to resize the normal way you would resize an object in PowerPoint.

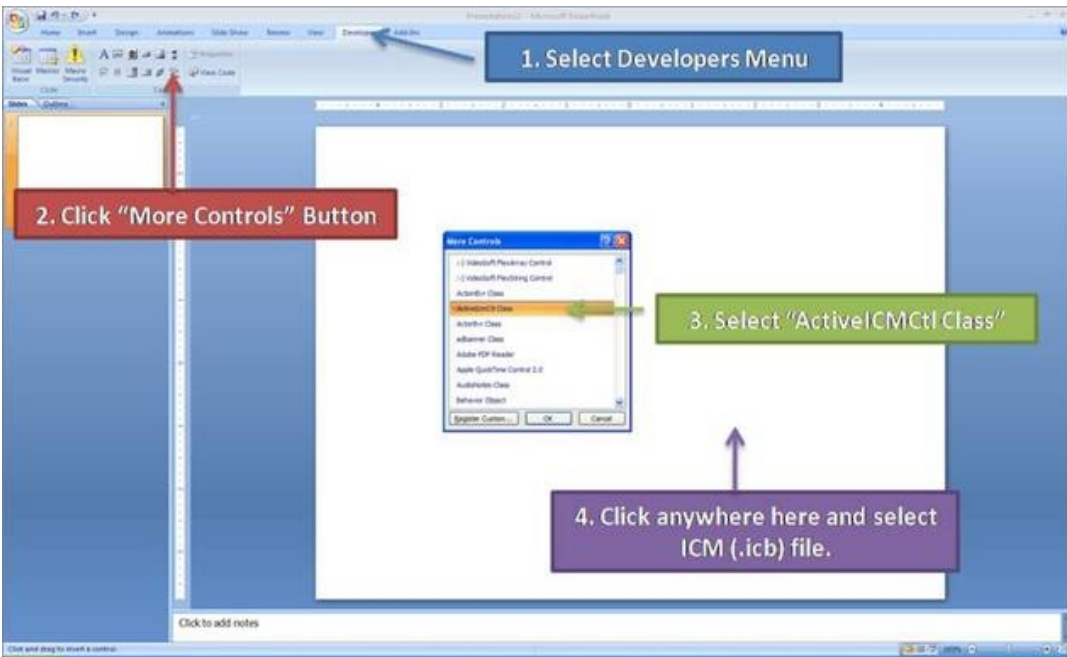

**6.3 Embed in Web Browser**

To embed in a web browser.

1. Download ActiveICM from here  
[http://www.molsoft.com/getbrowser.cgi?product=activeicm\(it is free!\)](http://www.molsoft.com/getbrowser.cgi?product=activeicm(it%20is%20free!))).
2. Create an HTML page in ICM (File/New/Html).
3. Add a series of slides.
4. File/Export As ActiveICM Html..

## 6.4 How to Use ActiveICM in PowerPoint

**\*\*IMPORTANT** *There are two ways to open a presentation:*

- Double click on the ppt file in windows folder. (in this case PowerPoint will set the current directory to the one which contains the file and there should be no problems with both relative and absolute paths)
- Open ppt through the "File-Open" or recent files. (in this case PowerPoint DOES NOT SET the current directory to the one which contains the file -> relative path might not work and user will be prompted to locate the ICB file unless file is found in absolute location)

*To view the slides you must be in Slide Show mode*

- Press the **F5** button to start the **Slide Show**. In edit mode (i.e. not presentation mode), the control is shown as a static image  $\frac{1}{2}$  it is not possible to interact with the ICB file. Therefore, to prepare the presentation so that the control shows the correct initial visualisations it is necessary to run the PowerPoint slide(s) in presentation mode

*Change Slides*

- Use the left and right cursor keys to change slides.

*A number of other options can be accessed by right clicking on the slide. These options include:*

- Select Slide
- Auto Play
- Set on/off rocking
- Center
- Load a new ICM File



*You can also add multiple ActiveICM 3D displays in one slide:*

- To display multiple ActiveICM 3D displays in one slide just copy the original display or repeat the steps described above. All powerpoint slides should point to the same ICM file (.icb) but they can point to different slides.

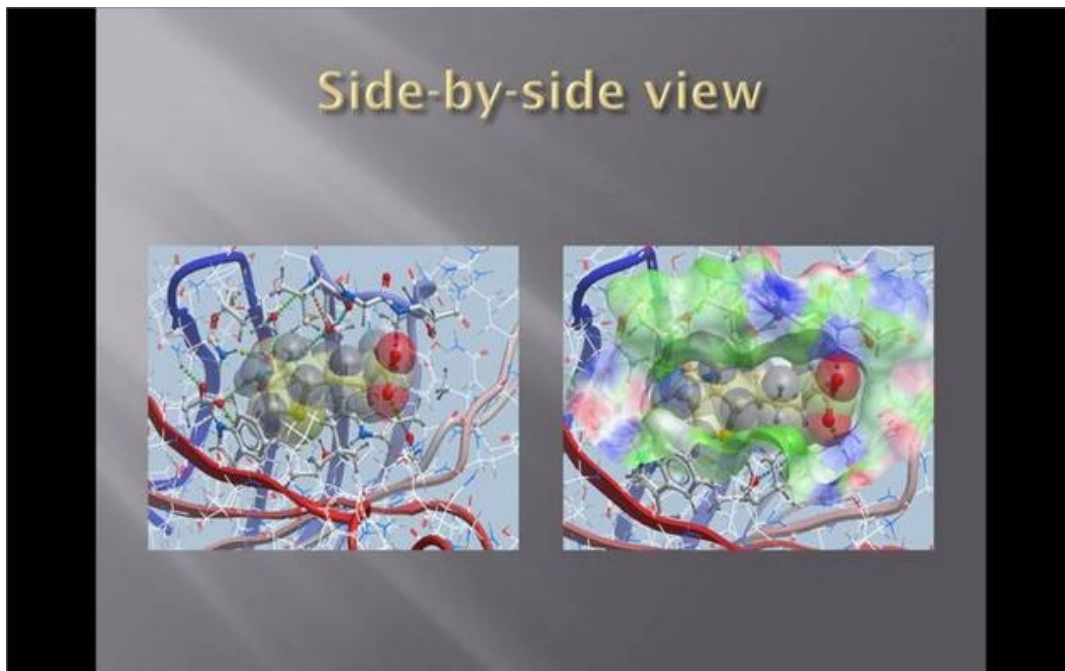

## 6.5 How to Change ActiveICM Component Properties

A number of properties of ActiveICM can be changed once embedded in powerpoint. The options include:

- Select the first slide to be displayed.
- Set slide auto play.
- Set auto play of a script.
- Embed the powerpoint file and the icb file all into one file.

To change these options:

- Right click on your embedded activeICM in Powerpoint.
- Select **Properties** and click on the button shown below.

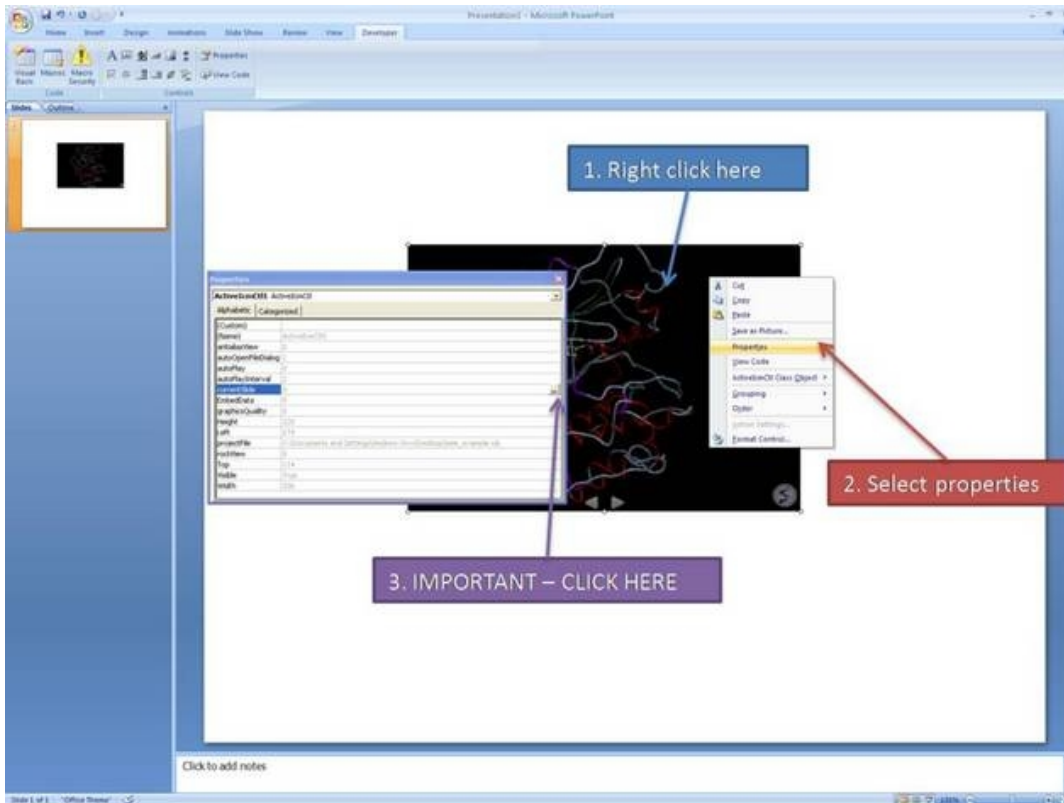

- A Property Pages window will then be displayed as shown below.

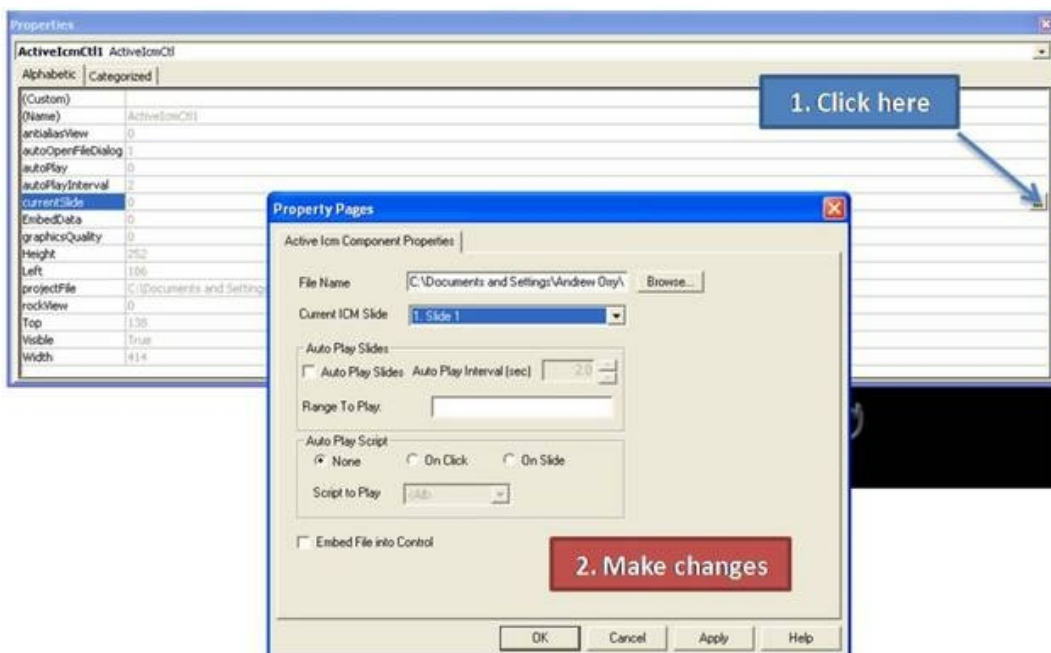

**To change the file name of the icb file linked to activeICM:** Simply type in the path to the file or use the browse option.

**To change the current ICM slide:** Use the drop down button next to **Current ICM Slide** to select the slide you wish to display first in your presentation.

**To auto play slides:** Check the **Auto Play Slides** box and select the interval between slides option. A range of slides can be played by entering the number of the slides separated by a comma.

**To auto play a script:** Select whether you want the script to run **On Click** or **On Slide** then select the script from the **script to play** drop down button. You should first save your script in the icb file.

**To embed the icb file in the ppt file** Click the **Embed File into Control** option. **Important** – Please save your PowerPoint file in the t 1997–2003 ppt format not pptx.

## 6.6 Advanced use of activeICM: Macros to direct visualisation changes

Documentation kindly provided by Dr. Brian Marsden (SGC Oxford  
<http://www.sgc.ox.ac.uk/people/brian/>)

It is possible to write simple VisualBasic scripts to avoid having to use the right-click menu approach to changing activeICM control slides within the control itself. This allows one to place buttons outside of the activeICM control, but in the same PowerPoint slide, which controls the control's behaviour. Below are a couple of useful examples of this approach.

*Creating a button to set the control's active slide:*

*Insert a button Office 2003*

- In edit mode, make sure the control toolbox toolbar is shown by right-clicking the blank area at the top of the top bar and ensuring **Control Toolbox** is ticked.

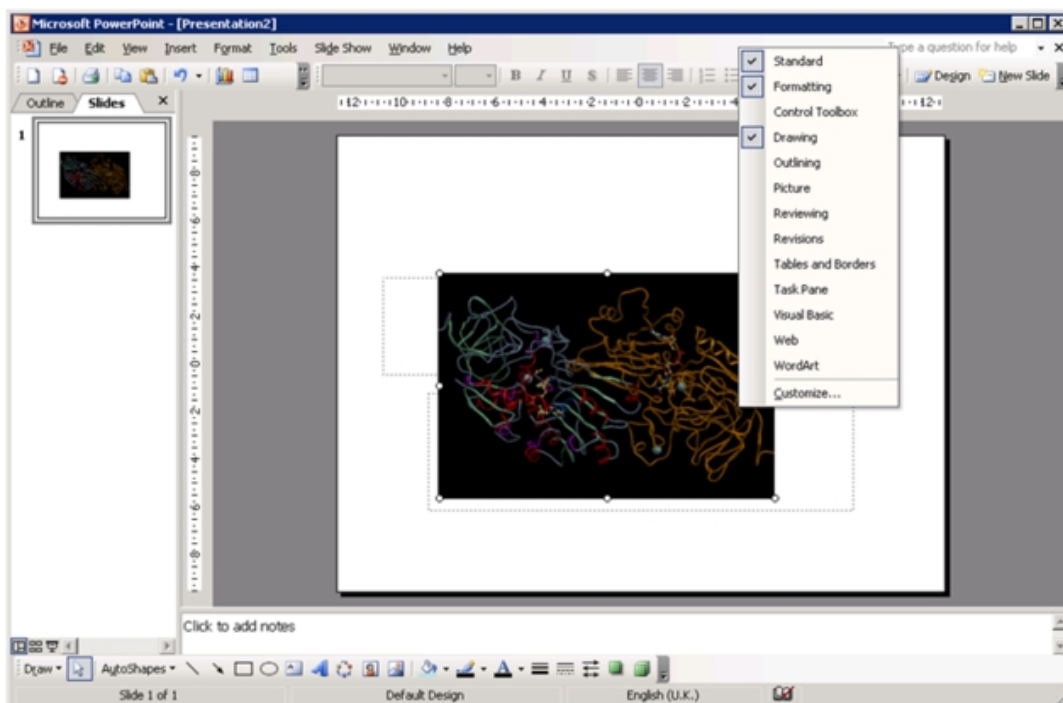

- Click on an icon in the Control Toolbox which corresponds to the sort of button you wish to use. Then click and drag in the PowerPoint slide to generate the button.

*Insert a button Office 2007:*

- In edit mode, click on an icon in the Developer menu or ribbon which corresponds to the sort of button you wish to use. Then click and drag in the PowerPoint slide to generate the button.

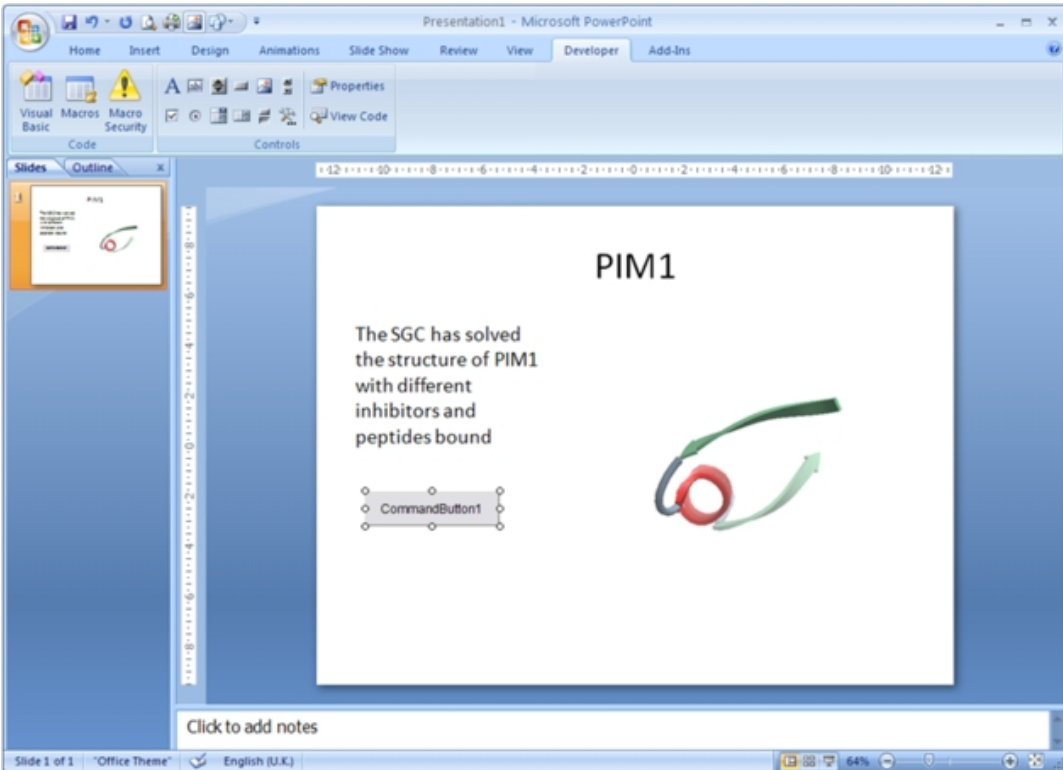

- Double-click on the new button to open the VisualBasic editor with two empty functions pre-defined. The first one pertains to the control itself and can be ignored in this context \*For the second function (which is for the newly-created button), copy the following into the editor, between the two lines of function code:

```
ActiveIcmCtl1.currentSlide = 2
```

- This sets the current activeICM control's slide to be number 3 **note** that the value placed in this code needs to be 1 less than the actual slide number (confusing, no?). Obviously, use a value here that makes sense in the context of your ICB file.
- This should leave the editor looking like this:

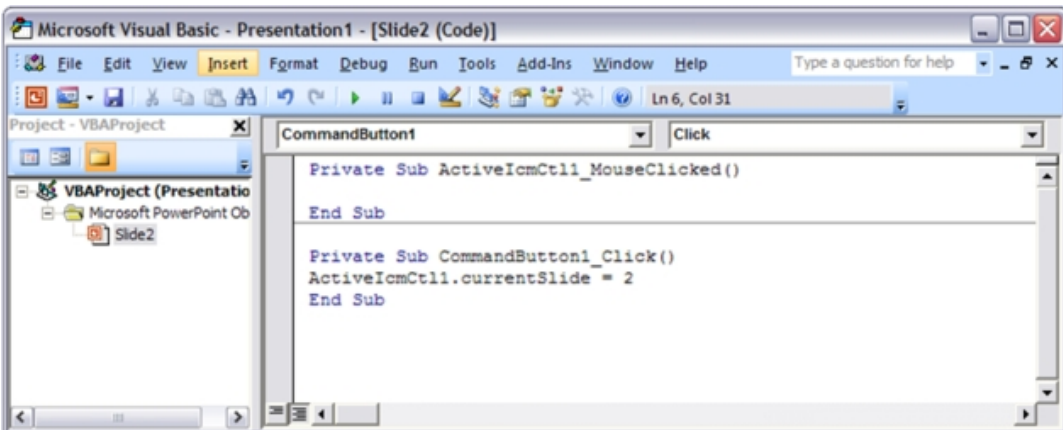

- Close the Visual Basic editor
- To change the physical properties of the button e.g. text, colour e.t.c.right-click on the button and select the Properties menu option. This opens up a dialogue as below, where many properties of the button can be changed:



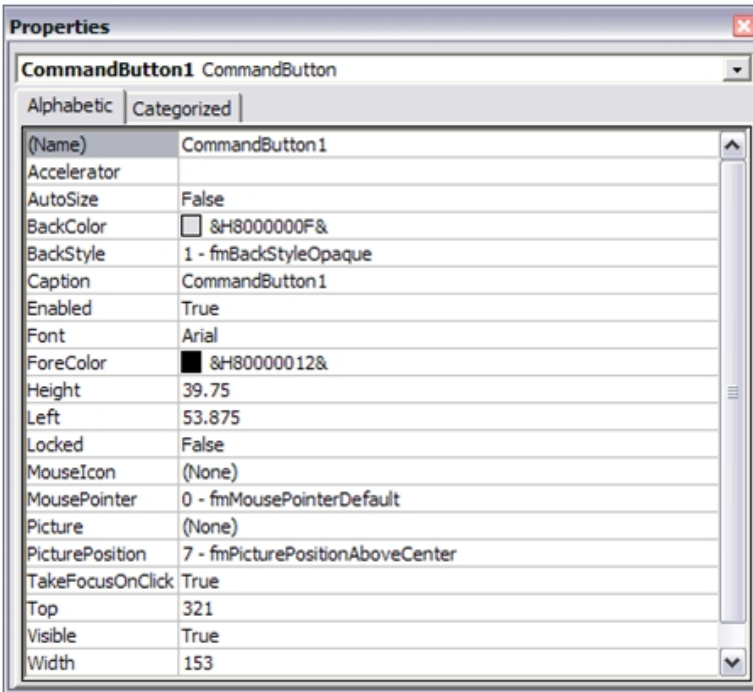

- Using this dialogue, it should be possible to disguise the button to look like normal text (for example) which can be clicked on during the presentation to change the visualisation of the control, apparently magically. Note that the button will only work in presentation mode.
- **IMPORTANT:** In Office 2007, remember to save the PowerPoint presentation now as a pptm file that is, a macro-enabled PowerPoint file otherwise the macros will not work next time you load the presentation.

**Other code examples:** Just copy and paste the example of interest inside the function for the button in the Visual Basic editor. Code that enables a button to cycle through the ICB files slides in order (including wrap-around)

```
currentSlide = ActiveIcmCtl1.currentSlide
numSlides = ActiveIcmCtl1.nofSlides
If currentSlide = numSlides - 1 Then
ActiveIcmCtl1.currentSlide = 0
Else
ActiveIcmCtl1.currentSlide = currentSlide + 1
End If
```

## 6.6.1 PowerPoint Cache Errors

PowerPoint caches some information about active controls. Sometimes after an ActiveICM upgrade you may get an error when trying to access some property or method: "Wrong number of arguments or invalid property assignment" or something similar.

In this case you need to close PowerPoint and remove all files from the location below:

C:\Documents and Settings\seva\Local Settings\Temp\PPT11.0



# 7 Movie Making

**Note:** Click **Next** (top right hand corner) to navigate through this chapter or use the links below. Headings are listed on the left hand side (web version) or by clicking the **Contents** button on the left-hand-side of the help window in the graphical user interface.

ICM enables users to easily make a movie. Here we will describe how to make and convert a series of frames and scenes into a movie. A movie is an excellent means of communicating results obtained in ICM such as Monte Carlo and docking simulations. The resulting movie can easily be transferred into other applications such as Microsoft Powerpoint.

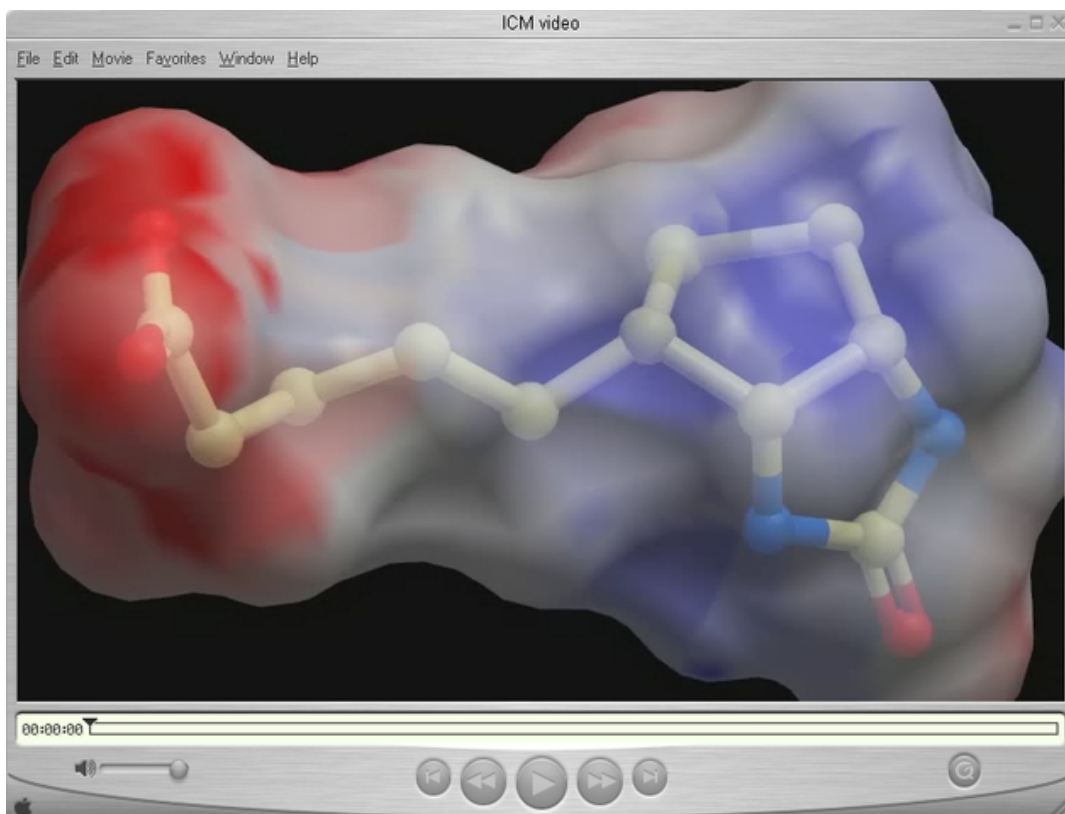

## 7.1 Movie Making Options

From version 3.4-9 onwards there are two ways to make a movie.

### 1. Screenshot Movie Making



— Screenshot movie making

### 2. View-Defined Movie Making

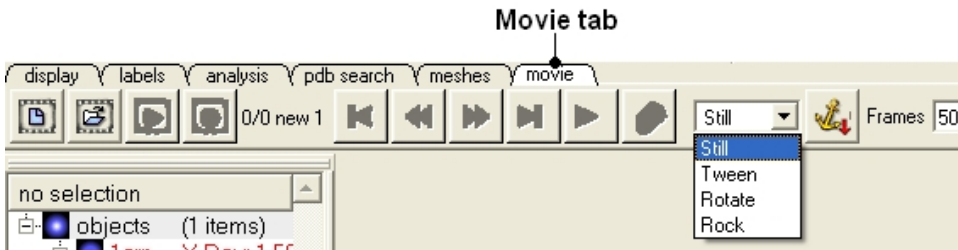

## 7.2 Screen-grabbing Movie

To make a **Screen-grabbing Movie** follow these steps:

- Resize the graphical display to the screen size/resolution you need. You may also want to select the high quality image button and antialiasing to improve the quality of the movie or add visual effects such as shadows.
- To begin making a movie click on the movie making button at the bottom of the graphical user interface (as shown below).
- Enter a file name for your movie and select the movie format (.mov, .avi, mpeg).

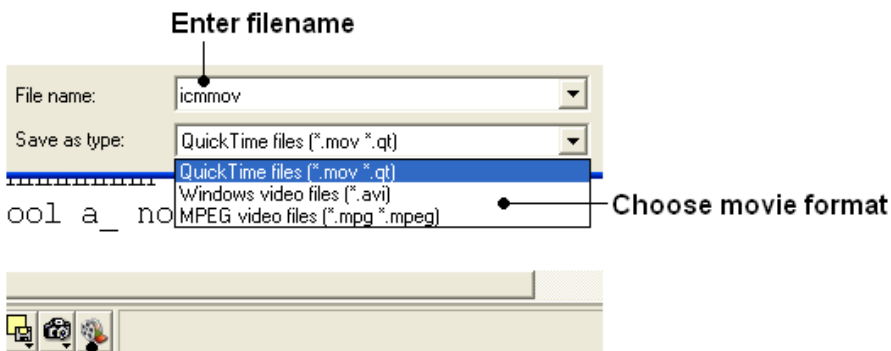

**Screenshot movie making button**

**NOTE:** If you want to make a movie to include in a PowerPoint presentation you need to save the movie in AVI format.

- To begin recording the screenshot movie click on the red **Record video** button. Anything displayed in the graphical display will be recorded, for example you can record animations and transitions. Specifying the number of cycles in the animation (rocking, rotation) is an ideal tool for screen-shot movie making. If you have a fast computer you can use **Realtime screen grabbing** which can be selected by clicking and holding the **Record video** button. The real time option can also be set in File/Preferences/Gui menu.



**Record video button**

- The length of the movie in minutes, seconds and milliseconds is displayed in the top right hand corner of the graphical display.



- You can pause the movie and fade out by clicking on the button shown below. The number of frames for the fading out option can be controlled using the option in File/Preferences/Gui

#### Pause and fade out



#### Pause recording

- You can record a smooth transition from a previous frame by clicking on the button shown below.

#### Smooth transition from previous frame



**NOTE:** Anything you do in the graphical display will be recorded in the movie. For example you can change representations, lighting, add new molecules etc. This can be achieved in a more controlled manner using the **pause** and **record smooth transition** button.

- Once you have paused the recording the viewpoint and representation of the molecules can be changed and a smooth transition from the previous frame can be generated by selecting the **Record smooth transition from previous frame** button.
- To stop recording a video press the button shown below.

#### Record smooth transition from previous frame



#### Stop recording

## 7.3 View-Defined Movie Making

### *Before starting to make a movie:*

1. First set up and make a directory into which you wish to store the movie.
2. Read the PDB files and objects you wish to include in the movie

### *A previously saved movie can be opened by:*

- Clicking on the movie open button shown below.



Open existing movie

### 7.3.1 Movie Files and Resolution Setup

*To start making a movie:*

- Select the movie tab.

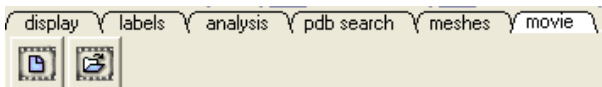

Open the directory of an existing movie.

Choose a directory to make a new movie.

- Click the button to choose a new movie directory (See Figure Above).

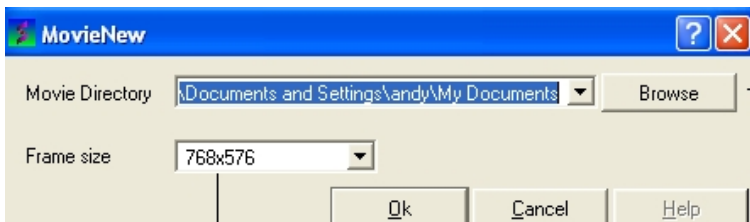

Locate your movie directory.

Define movie resolution

- Browse for your movie directory.
- Select which resolution you desire for your movie by selecting the appropriate frame size.
- Click OK.

### 7.3.2 Defining a Movie Scene

*The first step is to make the first scene.*

There are four choices of scene – still, tween, rotate or rock.

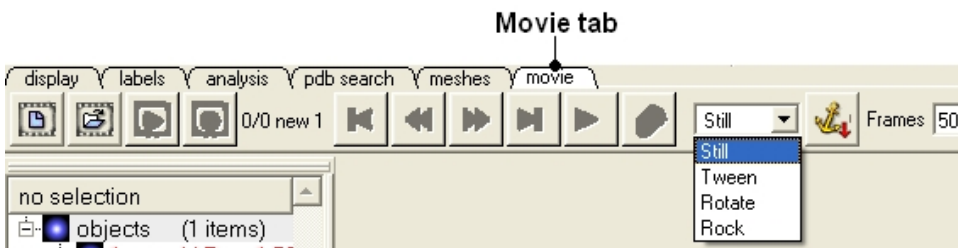

Select which scene you would like to start your movie with and follow the instructions for whichever one of the four scenes you choose.

### 7.3.3 Still

*To make a still scene:*

- Select the still option from the drop down list shown below.

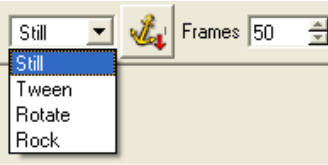

- Move the object to the starting position.
- Click on the "Define first view" button (see figure below).
- Type in the data entry box how many frames you desire for the scene.



Select the first frame

Select the number of frames you want for the first scene.

- If you wish to preview the still view click the "preview" button (see figure below)
- If you are happy with the scene, click the red record button.



Preview the still view

Record new scene

The number of scenes you have recorded so far is displayed in the video panel (see figure below).

Next scene number



The number of scenes currently in your movie is recorded here

### 7.3.4 Tween

*To make a "tween" scene (moving your object from one point to another):*

- Select the tween option from the drop down list shown below.

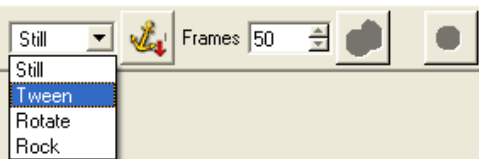

- Move the object to the starting position.
- Click on the "Define first view" button (see figure below).
- Type in the data entry box how many frames you desire for the scene.



### Define first view

- Move the object to the place you wish it to be translated to..
- Click on the "Define second view" button (see figure below).

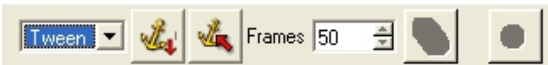

### Define second view

- Click on the button shown below to preview the interpolation between the two views.

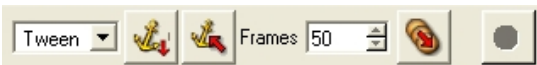

### Preview the interpolation between two views

- If you are happy with the scene, click the red record button.



### Record new scene

The number of scenes you have recorded so far is displayed in the video panel (see figure below).

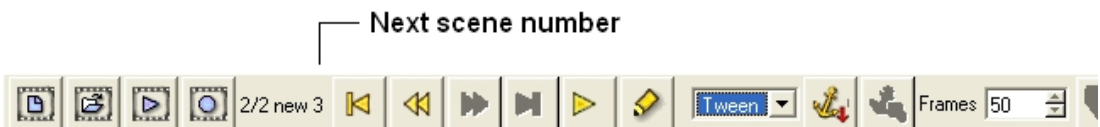

The number of scenes currently in your movie is recorded here

## 7.3.5 Rotate

*To make a "rotation" scene:*

- Select the rotate option from the drop down list shown below.



- Move the object to the starting position.
- Click on the "Define first view" button (see figure below).
- Type in the data entry box how many frames you desire for the scene.





Define first view

Now you have **three** preview options

1. Rotate around the x axis.
2. Rotate around the y axis.
3. Rotate around the z axis.

The buttons for each of the three options are shown below:



Rotate around x axis

Rotate around y axis

Rotate around z axis

- Enter by how many degrees you wish your object to be rotated.
- Click one of the three preview options – rotate x, rotate y and rotate around the z axis.

**NOTE** You can play with and change the number of degree option and which kind of rotation as many times as you wish until you are satisfied with your scene.

*Once you are satisfied with your scene:*

- Click the red record button.



Record new scene

The number of scenes you have recorded so far is displayed in the video panel (see below).

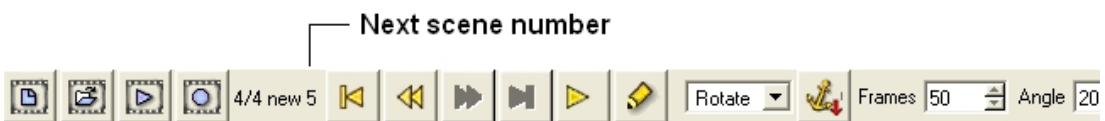

The number of scenes currently in your movie is recorded here

### 7.3.6 Rock

*To make your object perform a "rock" motion:*

- Select the rock option from the drop down list shown below.

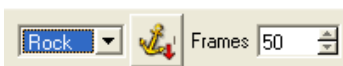

- Move the object to the starting position.
- Click on the "Define first view" button (see figure below).
- Type in the data entry box how many frames you desire for the scene.



**Define first view**

Now you have **three** preview options

1. Rock around the x axis.
2. Rock around the y axis.
3. Rock around the z axis.

The buttons for each of the three preview options are shown below:



Rock around x axis \_\_\_\_\_

Rock around y axis \_\_\_\_\_

Rock around z axis \_\_\_\_\_

To change the angle and the number of times the rock occurs, enter the desired numbers in the data entry boxes shown below.



Change angle of rock \_\_\_\_\_

Change number of rocks \_\_\_\_\_

*Once you are satisfied with your scene:*

- Click the red record button.



**Record new scene**

The number of scenes you have recorded so far is displayed in the video panel (see below).



**Next scene number**

The number of scenes currently in your movie is recorded here

### 7.3.7 Edit a Movie

*To edit a movie:*

- Select the scene you wish to edit by using the buttons shown below. The scene number is displayed in the movie panel.

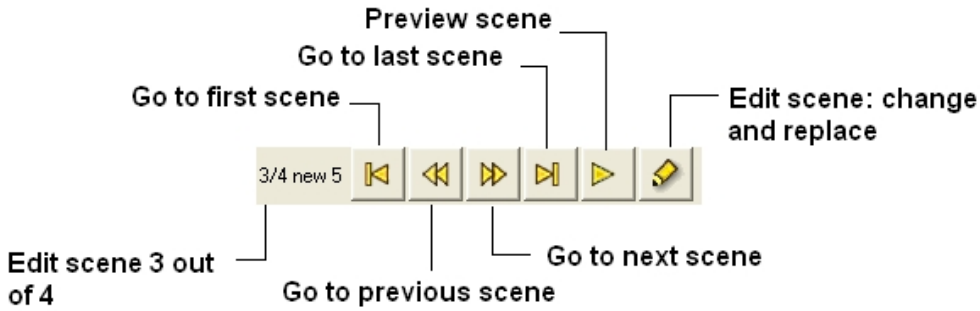

- Click the "Edit scene: Change or replace scene" button.
- Make changes to the scene as described in the *Movie Making* section of this manual.

### 7.3.8 Preview and Export

*To preview a movie:*

- Click on the preview movie button shown below.



*To export a movie to a series of png,gif,tiff files or an avi file:*

- Click on the export movie button shown below.



- Select which format you wish to save your movie.

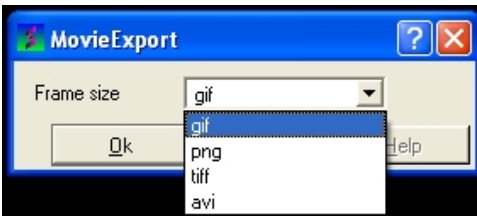

*If you select avi a window as shown below will be displayed:*

- Select which windows compression software you wish to use to make the movie.



# 8 Protein Structure Analysis

**Note:** Click **Next** (top right hand corner) to navigate through this chapter or click on the links below. Headings are listed on the left hand side (web version) or by clicking the **Contents** button on the left-hand-side of the help window in the graphical user interface.

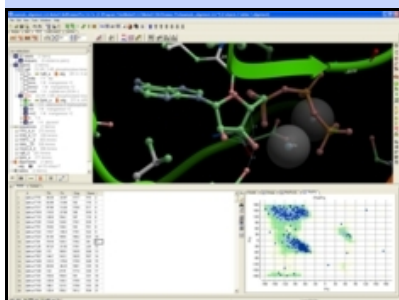

In this chapter we describe the tools available for analyzing protein structure. These tools include calculating RMSD, identifying closed cavities, calculating contact and surface area, measuring angles and distances, and generating Ramachandran plots.

## 8.1 Find Related Chains

This option allows you to search the currently loaded PDB files or ICM objects and identify chains which are similar and/or related.

You can do this by:

- Select the objects or pdb files you want to compare.
- Tools/Analysis/Find Related Chains
- Click OK to confirm the selection you made
- A table as shown below will be displayed.

	name1	name2	len1	len2	seqid	rmsd	consensus
1	2jc6.a	2jc6.c	278	277	100	0.12	SWKKQAEDIKIFEFKETLGTGAFSEVVLAEKATGKLFAY IENEIAVLRKIKHENIVALEDIYESPNHLYLVMQLVSGGELF
2	2jc6.a	3bhh.a	278	289	39	0.42	# # # E # G # V L # T G # A # K # I # + # # E E # ##R # K H N I V L D # # # Y L V # L V G G E L F - I V + # Y E D A S # I Q # L - A V # # # # H M G # V H R D L K P E N L L # # S # # P G Y # P E V L # Y K # V D # W # G V I # Y I L L # G Y P P F # D E
3	2jc6.a	3bhh.b	278	289	38	0.41	# # # E # G # # # V # T G # A # K # I # + # # E E #
4	2jc6.a	3bhh.c	278	285	37	0.44	# # # E # # # # E A # K # # + # # E E # # # R # K H
5	2jc6.a	3bhh.d	278	286	37	0.43	# # # E # # # # E A # K # # + # # E E # # # R # K H
6	2jc6.c	3bhh.a	277	289	39	0.44	# # # E # G # V L # T G # A # K # I K # E E # # # R
7	2jc6.c	3bhh.b	277	289	39	0.43	# # # E # G # # # V # T G # A # K # I K # E E #
8	2jc6.c	3bhh.c	277	285	38	0.44	# # # # - # V # # T G # A # K # I K # E E # # # R

**name1** = Name of query structure molecule **name2** = Name of hit **len1** = length of query **len2** = length of hit **seqid** = Sequence identity percentage **consensus** = Consensus sequence

## 8.2 Calculate RMSD

**NOTE:** This option is for protein structures only not for chemical compounds. You can use the command line options RMSD and SRmsd for chemicals.

*To calculate RMSD between two structure:*

- Read into ICM the two structures (File/Open or PDB Search or Read in Chemical) you wish to compare.
- Select the two structures you wish to superimpose. You can do this by double clicking on the name of the structure in the ICM Workspace (a selection is highlighted blue in the ICM Workspace and green crosses in the graphical display) or you can use the right-click button and drag it over the whole structure in the graphical display. Use the CTRL key to select more than one object in the ICM Workspace or use the **add** selection button if selecting more than one object in the graphical display.
- Tools/Analysis/RMSD and a window as shown below will be displayed.

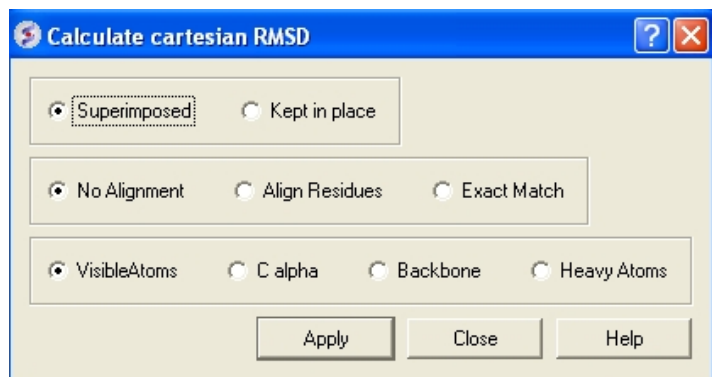

- Select whether you wish the atoms to be superimposed onto one another or kept in place. The kept in place option would be ideal for comparing docked structures.
- Choose whether you wish to make the superposition by alignment or exactly matching the atom names.
- Select which atom types you wish to superimpose.

The **RMSD** value will be displayed in the terminal window.

## 8.3 Contact Areas

- Read in a protein structure (File/Open or PDB Search)
- Select the region you wish to analyse.
- Tools/Analyze/Contact Areas
- The xstick display in the region will be scaled according to the atom/residue contact area. For example, residues making large contacts with a ligand will be displayed in thicker xstick representation than those making small contacts.
- A table as shown below will be displayed. Residues making key contacts will be displayed in xstick (radius represents contribution size). Carbon atoms are colored light green, nitrogen atoms are colored light blue and oxygen atoms are colored light red. The table lists the contact area, exposed area and the percentage of contact area compared to exposed.

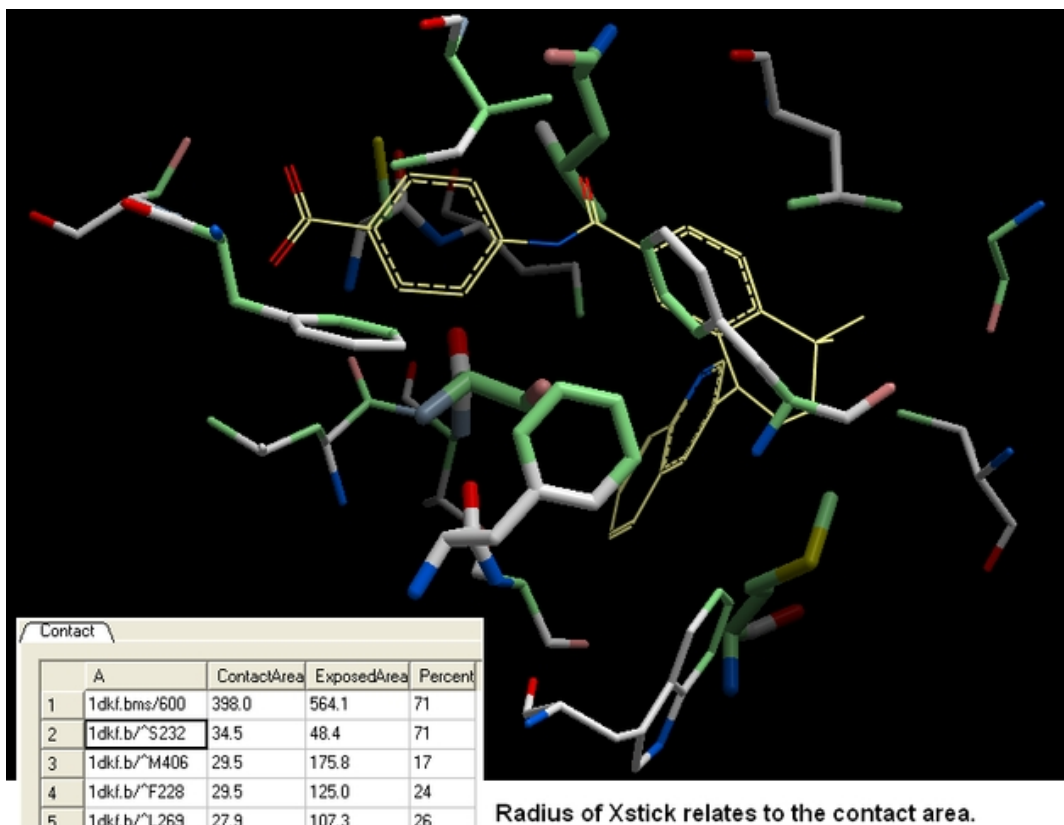

**NOTE:** You can also right click on the molecule in the ICM Workspace and select "Analyze Residue Contacts"

## 8.4 Identify Closed Cavities

This tool will identify cavities within a molecule which are completely closed,. If you are looking for buried and open pockets then use `icmPocketFinder`.

- Read in a protein structure (File/Open or PDB Search)
- Tools/Analysis/Closed Cavities
- Use the drop down arrow to locate the receptor you are interested in.
- Enter the minimum volume of the cavities you wish to identify.
- Click OK
- The closed cavities will be displayed in the meshes section of the ICM Workspace and a table of the cavities will be displayed. Double click on a row in the table to jump to a particular closed cavity and select the residues surrounding it.

Closed cavities are color coded with the graphical display

Double click here to select the residues surrounding the cavity

i	Volume	Area	Radius	Type
1	68.75	86.66	2.38	cavity2
2	28.14	50.15	1.683	cavity3
3	33.4	54.78	1.829	cavity4

## 8.5 Surface Area

This option calculates solvent accessible area of each selection in multiple objects and stores it in a table. If a molecule is specified in a multi-molecular object, the surface area of an isolated molecule is calculated and other molecules are ignored. The area is reported in square Anstroms and the probe radius is assumed to be the value set in the variable waterRadius.

Output: the macro creates table AREA . The empty comment field is added for user's future use. If the table exists, new rows are appended.

*To calculate a surface area:*

- Read in a protein structure (File/Open or PDB Search)
- Select the region you wish to analyse.
- Tools/Analysis/Surface Area
- A table will be displayed listing the residues in the selection along with the corresponding total surface area.

## 8.6 Measure Distances

There are two approaches to calculating and displaying distances between atoms. You can either use the options in the Labels tab or use Tools/Analysis/Distance

To display **all to all** distances:



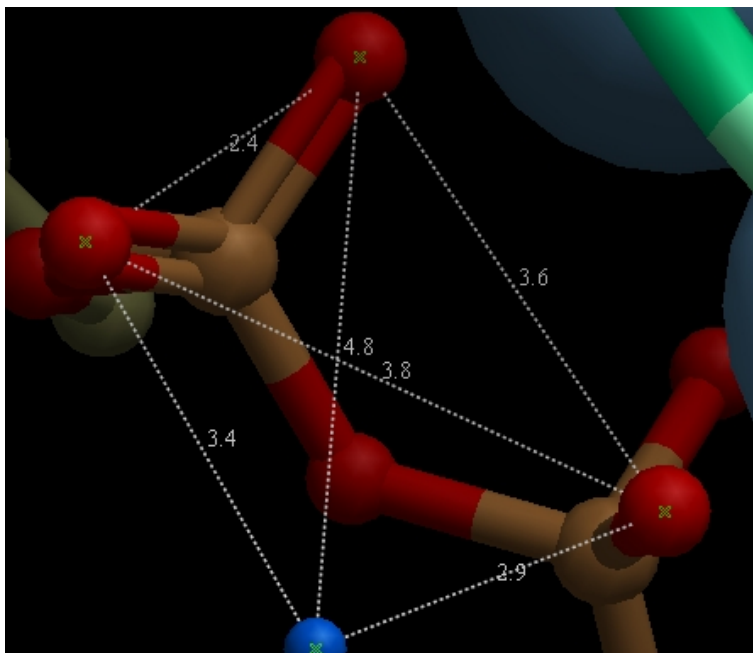

- Select the atoms between which you would like to find the distance. (See selection toolbar)
- Tools/Analysis/Distance
- Select all to all

To display **intermolecular** distances

- Select the atoms between which you would like to find the distance. (See selection toolbar)
- Tools/Analysis/Distance
- Select **intermolecular**

To display the distances between the same atoms in two objects.

- Select the atoms between which you would like to find the distance. (See selection toolbar)
- Tools/Analysis/Distance
- Select **same atoms in two objects**

You can also use the buttons in the **label** tab to display the distance between two atoms:

- Click on the labels tab (previously called advanced tab).
- Select the atoms between which you would like to find the distance. (See selection toolbar)
- Click on the 'Show Distances Between Two Atoms' Button
- The distance will be displayed in angstroms, in green.

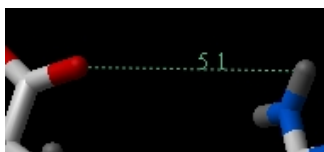

To find the distance from one atom to many:

- Click on the labels tab (previously called advanced tab).
- Select the atom from which you wish to measure the distance from (See selection toolbar)
- Click on the 'Show Distances From One Atom To Many' button.
- The distances will be displayed in green.

The maximal and minimal distances can be selected by entering values in the boxes shown here (below) in the labels tab (previously called Advanced tab).

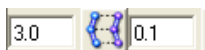

**NOTE:** Distances can be displayed and undisplayed in the 3D labels section of the ICM Workspace (left hand side of graphical user interface). You can change the color of a distance label by right clicking on it in the ICM Workspace. You can also export the distance to a table.

## 8.7 Planar Angle

If you wish to find the planar angle between three atoms:

- Select **Tools/Analysis/PlanarAngle**

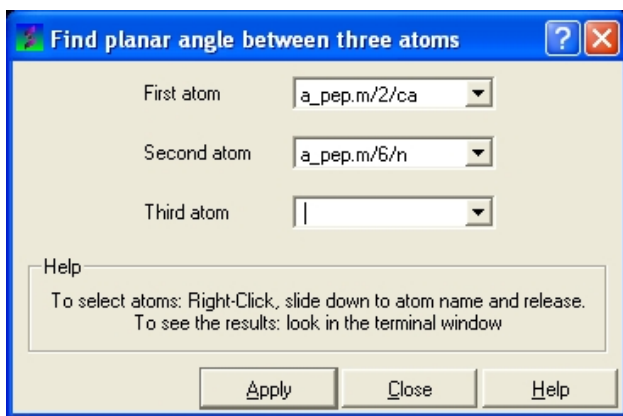

- Right click on the each of the three atoms which you wish to use, and select their name. The spaces next to **First atom**, **Second atom**, and **Third atom** should now contain the name of your atoms.

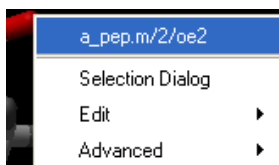

- Click **Apply** to display the angle measure in the terminal window.

Angle ( a\_pep.m/6/hh21 a\_pep.m/2/oe2 a\_pep.m/3/o ) = 74.72 deg.

## 8.8 Dihedral Angle

In order to find the angle dihedral angle between two sets of atoms:

- Select **Tools/Analysis/Dihedral Angles**.

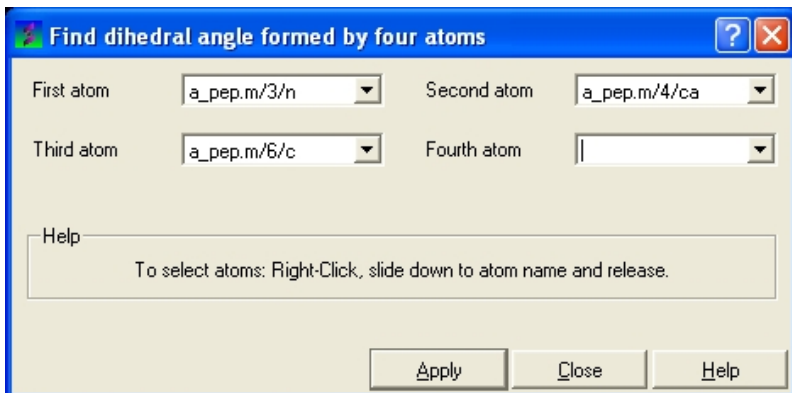

- Right click on each of the four atoms which you wish to use, and select the name of the atoms. The spaces next to **Atom 1**, **Atom 2**, **Atom 3**, and **Atom 4** should now contain the names of your atoms.

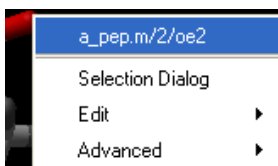

- To find the correct angle, select your atoms according to the following diagram:

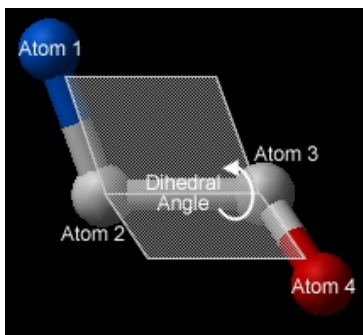

- Click **Apply** to display your dihedral angle measure in the terminal window.

## 8.9 Ramachandran Plot Interactive

To make an interactive ramachandran plot:

- Read in a protein structure (File/Open or PDB Search)
- Select the structure you wish to build the plot for. You can do this by double clicking on the name of the structure in the ICM Workspace (a selection is highlighted blue in the ICM Workspace and green crosses in the graphical display) or you can use the right-click button and drag it over the whole structure in the graphical display.
- Tools/Analysis/Ramachandran Plot Interactive
- The interactive ramachandran plot will be displayed in table called **RAMA**.
- You can view the **Omega**, **Phi/Psi** (Gly) or Phi/Psi angles by clicking on the tabs at the top of the plot. Each point is linked to the data in the table **RAMA** and also to the graphical display. Soby clickin on a point in the plot will highlight the corresponding angles in the table and also center on this region in the 3D display.

## 8.10 Export Ramachandran Plot

- Read in a protein structure (File/Open or PDB Search)

- Select the structure you wish to build the plot for. You can do this by double clicking on the name of the structure in the ICM Workspace (a selection is highlighted blue in the ICM Workspace and green crosses in the graphical display) or you can use the right-click button and drag it over the whole structure in the graphical display.
- **Tools/Analysis/Ramachandran Plot Export**

A postscript viewer needs to be downloaded onto your machine in order to view the plot. This can be downloaded from <http://www.cs.wisc.edu/~ghost/>. Once this software is downloaded you need to tell ICM where it is located by typing the pathname into File/Preferences.

**NOTE:** You can always export the plot as an image directly in ICM without exporting. You can do this by right clicking on the plot and select **save as image**. Another approach could be to export the RAMA table to Excel and use the plotting tools there. You can do this by right clicking on the table name tab and selecting "Export to Excel" or save as ".csv".





## 9 Proteins Superposition

**Note:** Click **Next** (top right hand corner) to navigate through this chapter or click on the links below. Headings are listed on the left hand side (web version) or by clicking the **Contents** button on the left-hand-side of the help window in the graphical user interface.

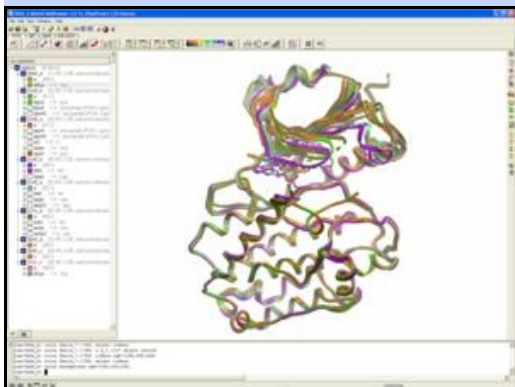

One or more proteins can be superimposed. Simply select the molecules or parts of the molecules you wish to superimpose and then use the selection of protein superimpose tools described in this section. For example a convenient superimpose button can be found in the display tab (see below).

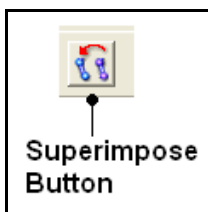

### 9.1 Select Proteins for Superposition

Before any superposition operation can be undertaken you need to select the protein structures you wish to superimpose.

One way to do this is by selecting in the ICM workspace. For other selection tools please see the Making Selections section of the manual.

- Select both receptors by double clicking on the name of the receptor in the ICM Workspace. To select two receptors use the Ctrl button or use the shift button to select a range of objects in the ICM Workspace. A receptor which is selected will be highlighted in blue in the ICM Workspace and with green crosses in the graphical display.

Green crosses indicates that the object is selected in the graphical display

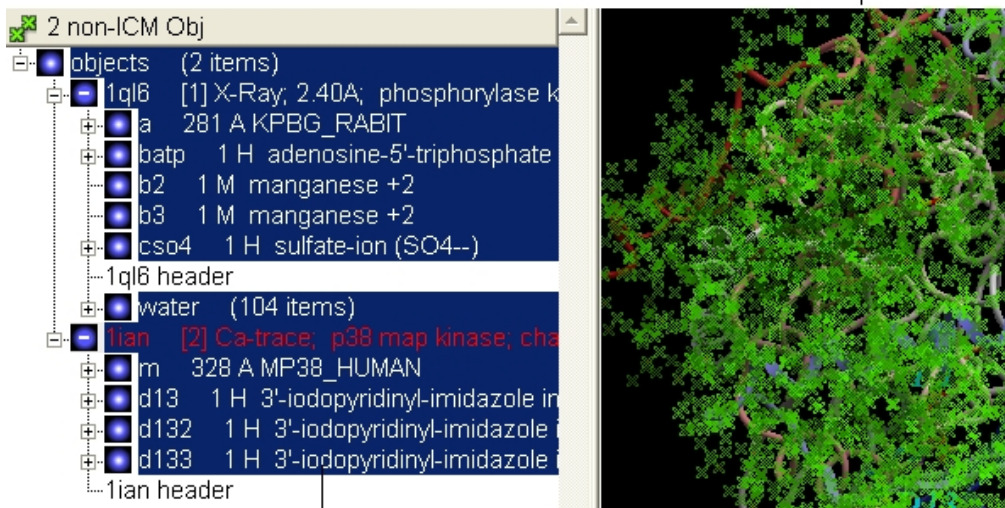

Highlighted blue means that the object is selected in ICM Workspace

Once the molecules are selected you can then superimpose them using the options described in the next section of this manual.

## 9.2 Superimpose Button

In order to calculate the root mean square deviation (RMSD) between two structures it is necessary to superimpose them. By using the superimpose button in the **display** tab, ICM will calculate the Ca-atom, backbone atom and heavy atom differences between the two structures. More advanced superimpose options can be found in the **Tools/Superimpose** menu.

To superimpose two structures which have the same number of residues and atoms:

- First load the two structures into ICM.
- Select which parts or all of the two structure you wish to superimpose (see selection toolbar).
- Select the **display** tab (previously called Advanced tab) at the top of the GUI.
- Select the superimpose button.



Superimpose Button

The rmsd will be displayed in the terminal window as shown below:

```
Info> 64 atoms superimposed, rmsd=1.381643
icm/ly6> superimpose ( Res( as_graph ) & a_./ca,c,n,o ) & Obj( as_graph )[1]
Warning> [110] skipped 4 atom pairs with zero occupancies
Info> 64 atoms superimposed, rmsd=1.381643
icm/ly6>
```

RMSD displayed here



## 9.3 Superimpose by 3D

*To superimpose proteins by 3D:*

- First display and select the proteins you wish to superimpose by 3D.
- Tools/Superimpose/Proteins by 3D
- A window as shown below will be displayed.

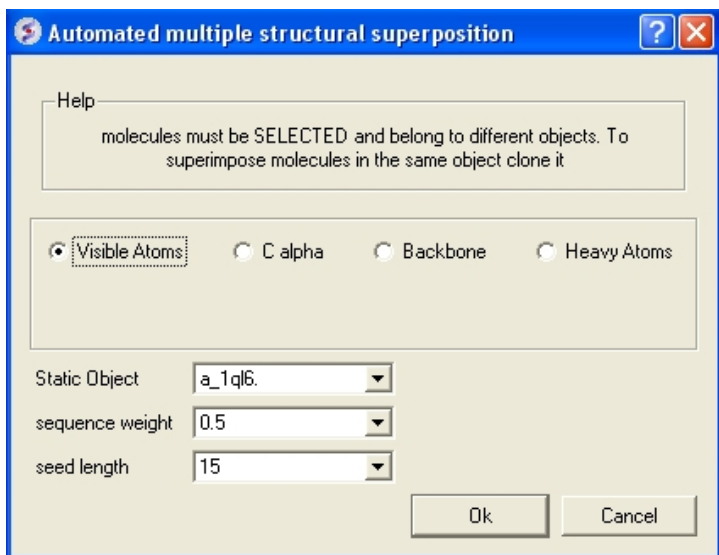

- Select by which atoms you wish to superimpose.
- Enter the ICM selection language description for the protein structure you wish to remain static. You can also use the drop down arrow button to select it.
- Enter the **sequence weight** Average local sequence alignment score.
- Enter the **seed length** This is the similarity window size.

## 9.4 Superimpose Multiple Proteins

*To superimpose multiple proteins:*

- First display and select the proteins you wish to superimpose by 3D.
- Tools/Superimpose/Multiple Proteins
- A window as shown below will be displayed.

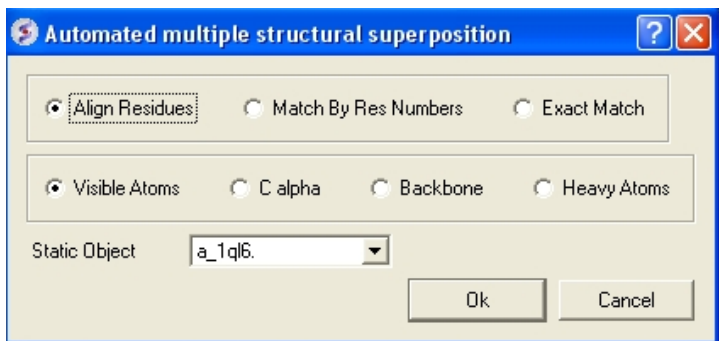

- Select by which method you would like to superimpose

**Align Residues** – Residue correspondence is established by sequence alignment using the ICM ZEGA alignment Abagyan, Batalov, 1997. Atom alignment: by atom name.

**Match by Res Numbers** – Residue alignment by residue number. Atom alignment: by atom name for pairs of identical residues or pairs of close residues (F with Y; B with D,N; D with N; E with Q or Z, Q with Z),

for other residue pairs only the backbone atoms ca,c,n,o,hn,ha are aligned.

**Exact Match** – Residue alignment is by the Needleman and Wunsch method. Inside residue atoms are aligned sequentially and regardless of the name.

- Select which atoms you would like to superimpose. Visible Atoms, C alpha, Backbone, or Heavy Atoms.

## 9.5 Arrange as Grid

*To separate superimposed proteins:*

- Tools/Superimpose/Arrange as Grid

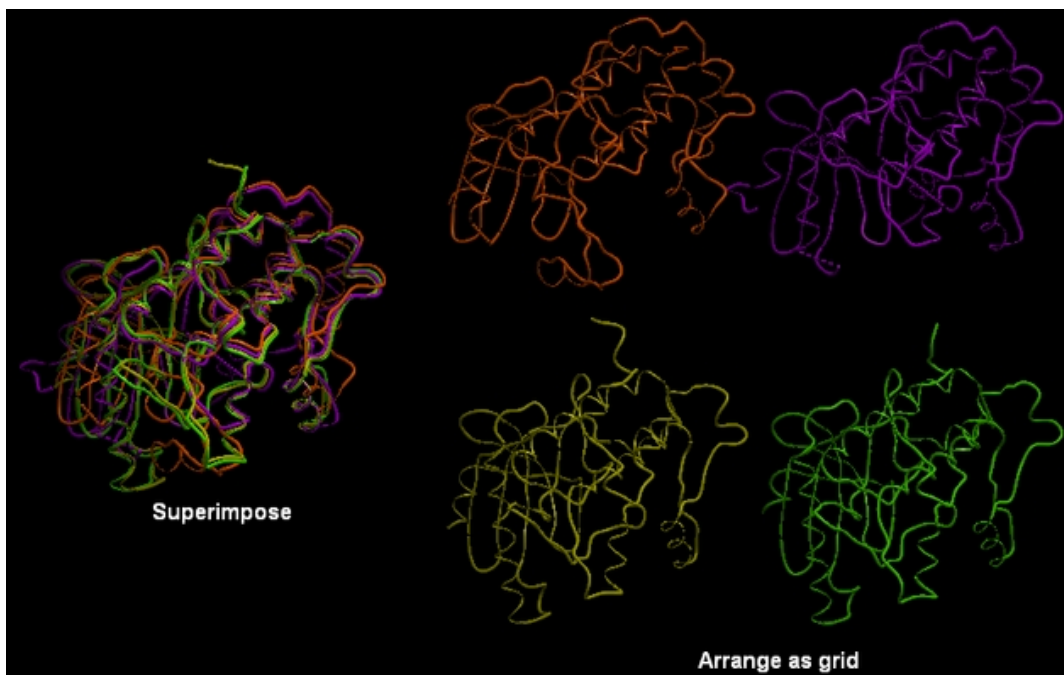





# 10 Crystallographic Analysis

**Note:** Click **Next** (top right hand corner) to navigate through this chapter or click on the links below. Headings are listed on the left hand side (web version) or by clicking the **Contents** button on the left-hand-side of the help window in the graphical user interface.

## 10.1 Crystallographic Neighbor

### *Theory*

Molecular objects and 3D density maps may contain information about crystallographic symmetry. It consists of the following parameters:

1. Crystallographic group eg. P2121 that determine N (depends on a group) transformations for the atoms in the asymmetric unit.
2. Crystallographic cell parameters A, B, C, Alpha, Beta and Gamma

To generate the coordinates within one cell one needs to apply N transformations and then to generate neighboring cells the content of one cell needs to be translated in space according to the cell position.

ICM has a function which generates crystallographic neighbors for the selected atoms. For large proteins it is impractical to generate neighbors for the whole molecule due to the high number of atoms in all neighboring molecules.

This information allows to generate symmetry related parts of the density or molecular objects.

### *To generate symmetry related molecules around a selection of atoms:*

- Read a PDB file into ICM. For instruction see the section entitled `Finding a PDB Structure`.
- Display the structure and select the residues around which the symmetry will be generated. For information on how to select residues see the `Making Graphical Selections` section.

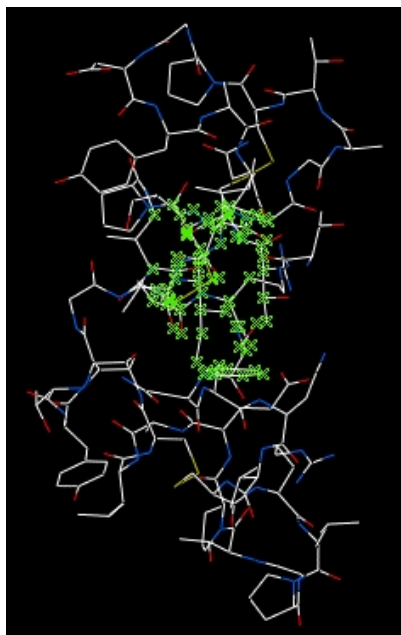

- Select the menu `Tools/Xray/Crystallographic Neighbors`.

A data entry box as shown below will be displayed.

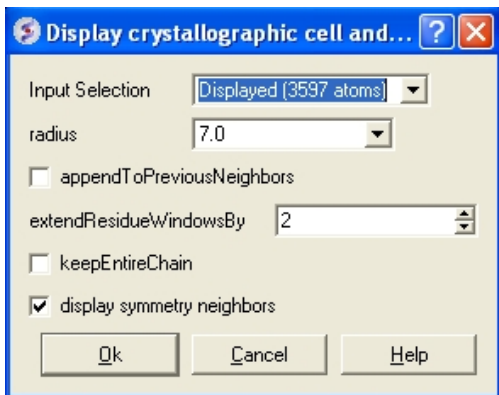

- Select the object.
- Enter the radius around your selection from which you wish to construct the symmetry related molecules.
- If you have made symmetry related molecules previously you can select **appendToPreviousNeighbors** otherwise leave unchecked.
- The **extendResidueWindowsBy** option will allow a window of residues outside of the selection radius selected above to be displayed
- If you leave the **keepEntireChain** unchecked then a fragment of each neighbor will be created. If you check this box the full neighbor will be generated
- Check display symmetry neighbors to display them in the graphics window. The nearest neighbor residues will be displayed in xstick representation and the each neighbor colored by molecule.
- Click OK.

The crystallographic symmetry neighbors will be displayed in the Workspace. By default the object will have the object name + "Sym" and each of the neighbors will be individual molecules.

For packing analysis and display you can color each symmetry unit a different color as described in the Structural Representations Color section. This is shown in the picture below.

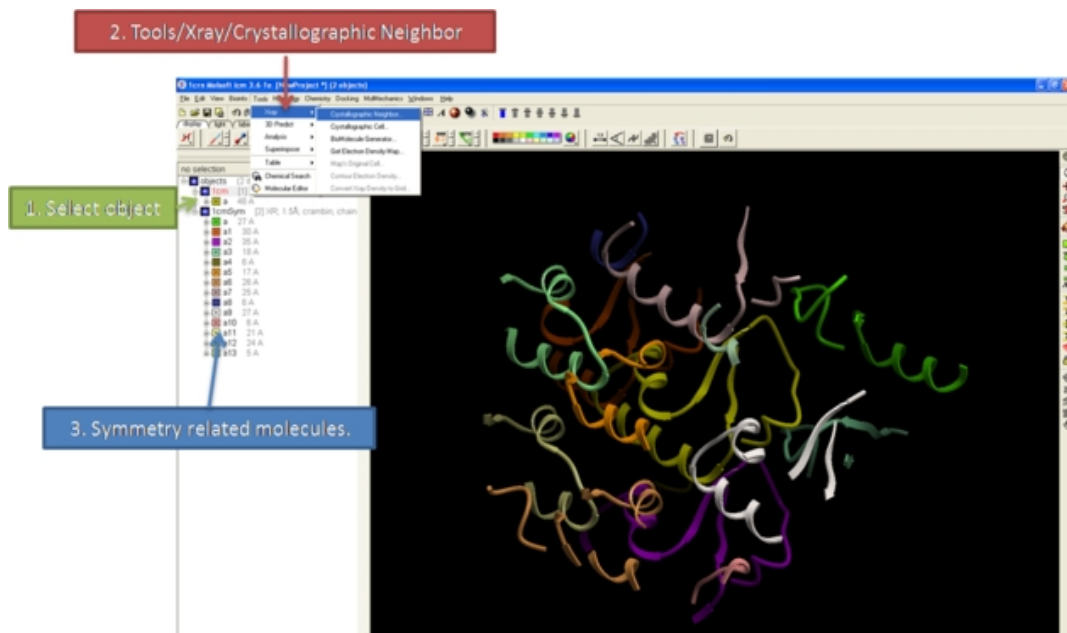

## 10.2 Crystallographic Cell

### Theory

The crystal structure of a protein is often discussed in terms of its unit cell. The unit cell is a box containing one or more motifs, a spatial arrangement of atoms. The units cells are tiled in three-dimensional space to

describe the crystal. The unit cell is given by its lattice parameters, the length of the cell edges and the angles between them, while the positions of the atoms inside the unit cell are described by the set of atomic positions measured from a lattice point.

To display the crystal cell of a PDB structure:

- Read a PDB file into ICM. For instruction see the section entitled *Finding a PDB Structure*.
- Select the whole object. You can do this by double clicking on the name of the structure in the ICM Workspace (a selection is highlighted blue in the ICM Workspace and green crosses in the graphical display) or you can use the right-click button and drag it over the whole structure in the graphical display.
- Select the menu Tools/Xray/Crystallographic Cell and a data entry box will be displayed.
- Click OK

The crystallographic cell will be displayed as a box as shown below.

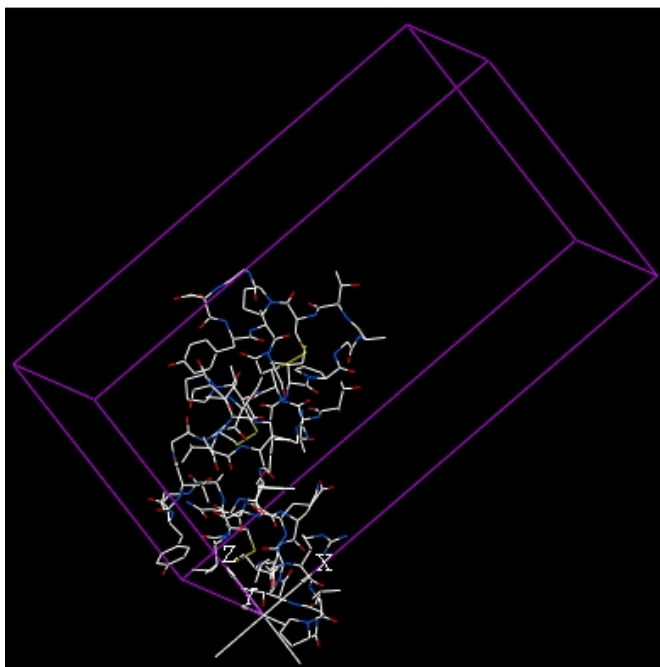

## 10.3 Biomolecule Generator

### *Theory*

It is very useful to know how a protein from the PDB may look in a biological environment. The PDB entries solved by X-ray crystallography and deposited in the PDB contain the information about the crystal structure rather than the biologically relevant structure. For example, for a viral capsid only one instance of capsid protein complex will be deposited and only one or two molecules of haemoglobin that is a tetramer in solution maybe deposited.

In some other cases the asymmetric unit may contain more than one copy of a biologically monomeric protein. ICM reads the biological unit information and has a tool to generate a biological unit. Not every PDB entry has the biological unit information.

A gallery of images created using the ICM Biomolecule generator is shown below:

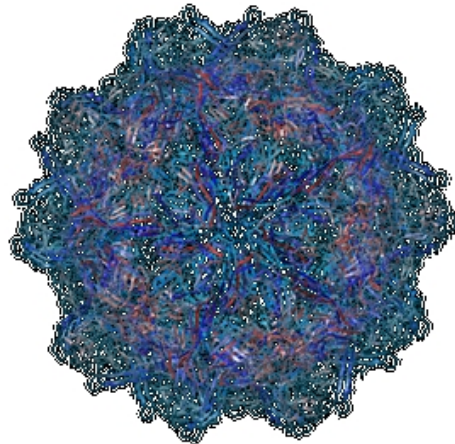
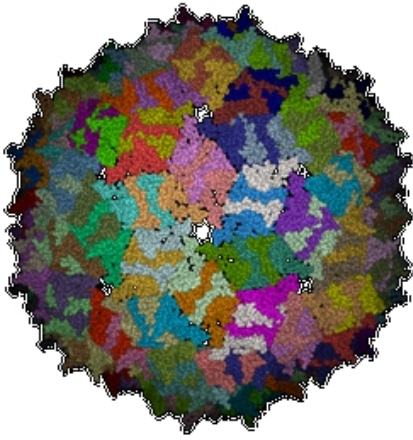

**Left:** PDB: 1DWN Bacteriophage Pp7 From *Pseudomonas Aeruginosa* At 3.7 Å Resolution **Right:** PDB: 1C8E Feline Panleukopenia Virus Empty Capsid Structure At 3.0 Å Resolution

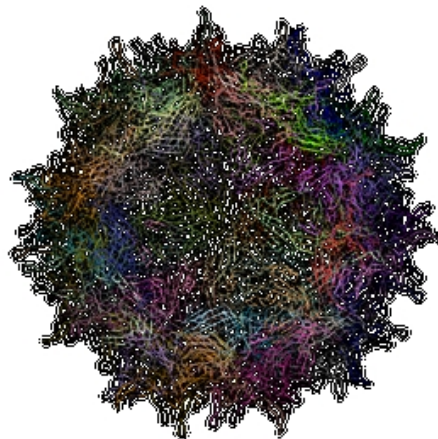
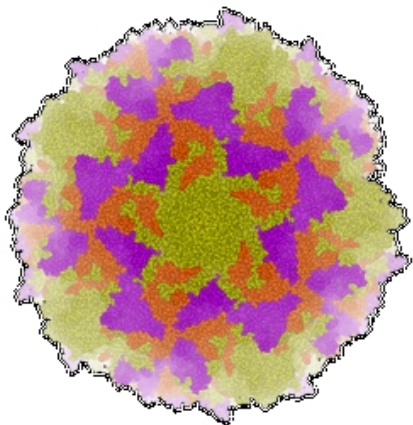

**Left:** PDB: 1AL2 P1/Mahoney Poliovirus, Single Site Mutant V1160I At 2.9 Å Resolution **Right:** PDB: 1LP3 Adeno-Associated Virus (Aav-2), A Vector For Human Gene Therapy At 3.0 Å Resolution

**NOTE:** Right click on a PDB structure in the ICM workspace to determine whether a structure from the PDB has biological unit information. If it does have this information then there will be an option in the menu entitled "Generate Biomolecules" if not the option will be blanked out.

**To generate a biological unit with ICM:**

- Select the object or PDB file.
- Select the menu Tools/Xray/Biomolecule Generator.
- Tick the **makeAllBiomolecules** box.
- Click OK – with very large molecules the biomolecule generation may take some time.

## 10.4 Get Electron Density Map

### Theory

An electron density map is a representation of a crystal structure based on the diffraction data. The map is constructed by a summation of waves of known phase, amplitude and frequency using Fourier transform. The electron density map of a protein can be viewed along with the pdb structure. The easiest way to view the electron density map is to contour and convert it into a graphical object (mesh).

A figure showing the electron density contours surrounding the ATP molecule in pdb entry 1ATP.



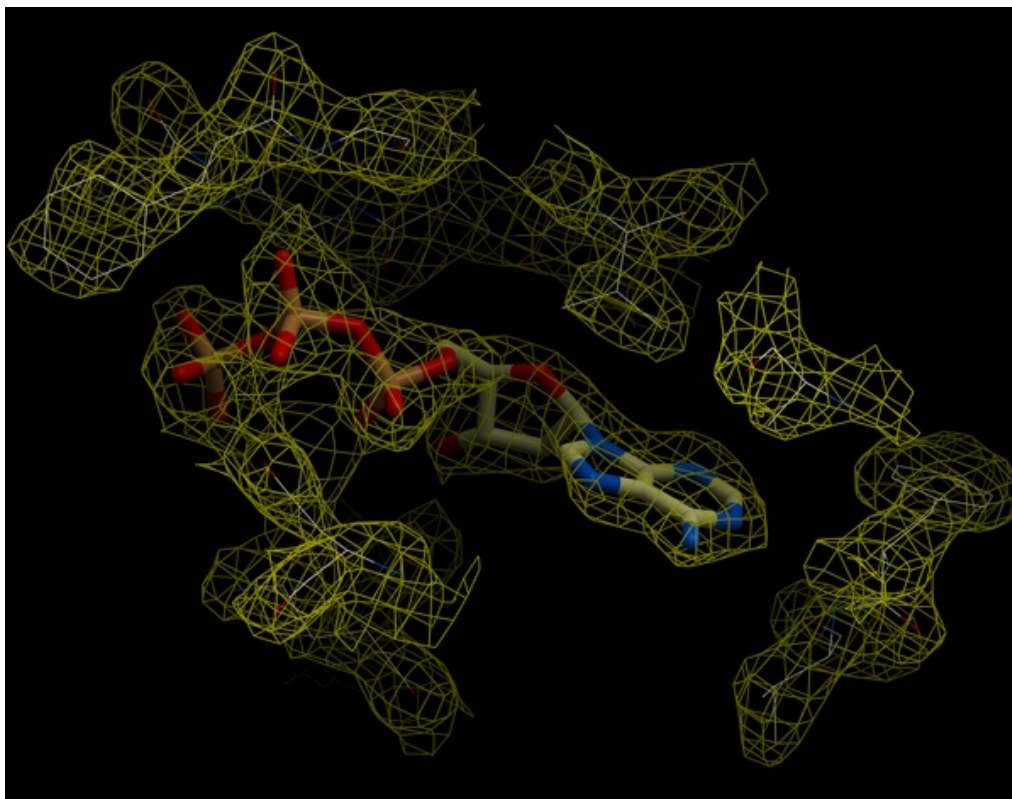

*To load an electron density map:*

- Tools/Xray/Get Electron Density Map
- Enter the PDB code of the map you would like to view.
- Click OK and the map will be downloaded from the Uppsala Electron Density Server.

The map will be represented in the ICM Workspace as shown below.

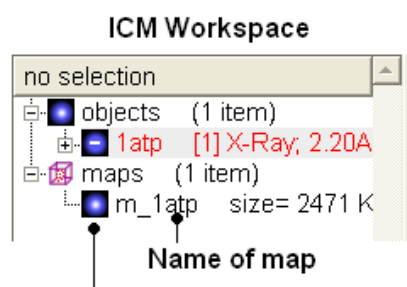

**Display and undisplay map here**

The map can be displayed as shown below however a clearer way of representing the density is to contour the map into a graphical object (mesh) as described in the following section.

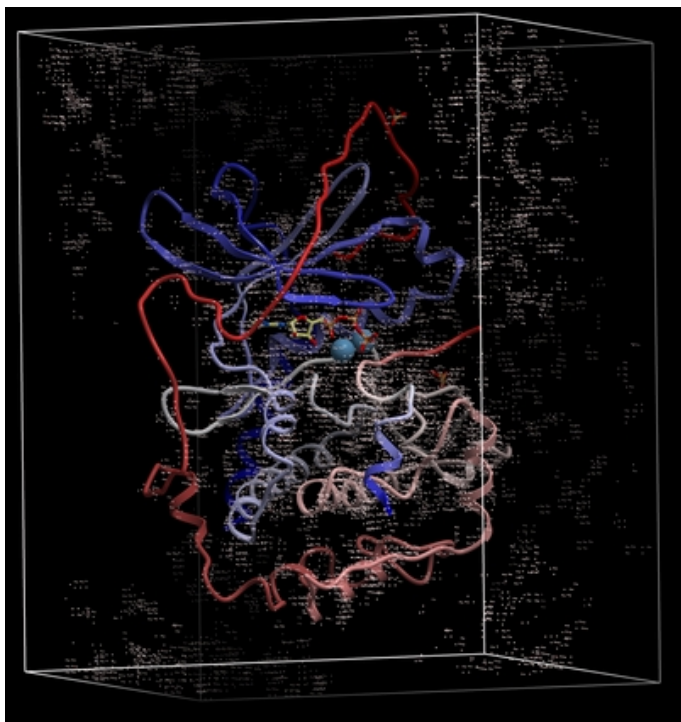

## 10.5 Map's Original Cell

*To display the original crystallographic cell of an electron density map:*

- Tools/Xray/Map's Original Cell
- Enter the name of the map or use the drop-down button to locate it. If you do not know the name of the map the name can be located in the ICM Workspace.
- Click OK and the cell will be displayed. The map can be displayed and undisplayed in the **meshes** section of the ICM Workspace.

**Generated cell**

4b A

meshes (1 item)

gCellMap v=8 l=1:

maps (1 item)

m\_2bdw size= 94

Name of map

Map's Original Cell

map m\_2bdw

Ok Cancel

## 10.6 Contour Electron Density Map

*To contour an electron density map and display as a graphical object:*

- Load an electron density map as described earlier in the Load Map section.
- Read in the PDB file – File/Load PDB or use the PDB search tab.
- Tools/Xray/Contour Electron Density.
- Enter the name of the map e.g. m\_1atp – the name of the map is displayed in the ICM Workspace or use the drop down arrow to locate it.
- If nothing is displayed then the whole map will be contoured. If you only want to contour a particular region of the map then you need to display that region of the PDB structure. Eg the binding pocket.
- Enter a sigmaLevel value for more information see: <http://www.molsoft.com/man/reals.html#mapSigmaLevel>. Once the contoured

map has been created the sigma level can be changed manually using the +/- buttons in the ICM workspace.

- In ICM versions 3.6–1f and above there is an option to **Keep All Density in Box**. If this option is checked the density will be contoured around a box surrounding your selection if you do not check this box only the atoms selected will be contoured.

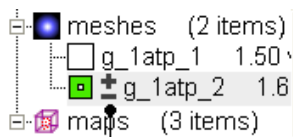

Click here to increase or decrease the sigma level of the contouring

- Click OK and the mesh will be displayed. Right click on the mesh in the ICM Workspace for display options (see below).

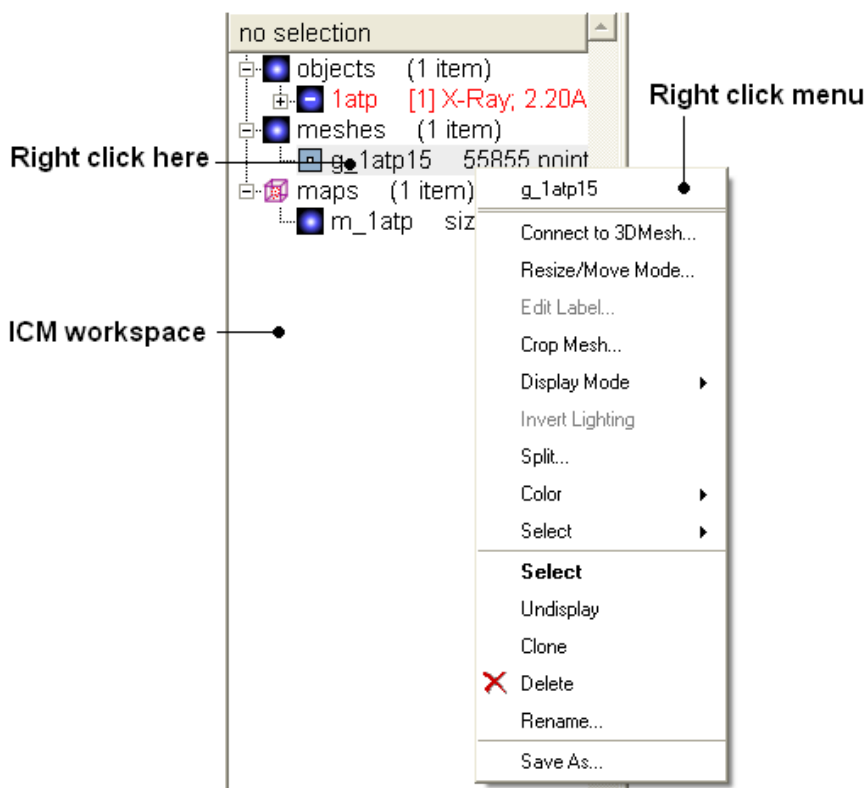

**NOTE:** Meshes can be cut away using the mesh clipping tools.

## 10.7 Convert Xray Density to Grid

For some applications, such as trying to fit a structure to a density map, you may want to extract a sub map and convert to a grid. You can do this by

- First read into ICM a map (eg File/Open or Tools/X-ray/Get Electron Density Map)
- Tools/X-ray/Convert Xray Density to Grid
- Enter the map name or use the drop down list
- Enter a grid size
- Click OK



# 11 3D Predict

**Note:** Click **Next** (top right hand corner) to navigate through this chapter or use the links below. Headings are listed on the left hand side (web version) or by clicking the **Contents** button on the left-hand-side of the help window in the graphical user interface.

## 11.1 Assign Helices and Strands

### Theory

The **Assign helices and Strands** option will manually reassign secondary structure to a protein structure. This command does not change the geometry of the model, it only formally assigns secondary structure symbols to residues. If the secondary structure string is not specified, apply ICM modification of the DSSP algorithm of automatic secondary structure assignment (Kabsch and Sander, 1983) based on the observed pattern of hydrogen bonds in a three dimensional structure. The DSSP algorithm in its original form overassigns the helical regions. For example, in the structure of T4 lysozyme (PDB code 1031) DSSP assigns to one helix the whole region a<sub>93</sub>:112 which actually consists of two helices a<sub>93</sub>:105 and a<sub>108</sub>:112 forming a sharp angle of 64 degrees. ICM employs a modified algorithm which patches the above problem of the original DSSP algorithm. Assigned secondary structure types are the following: "H" – alpha helix, "G" – 3/10 helix, "I" – pi helix, "E" – beta strand, "B" – beta-bridge, "\_" or "C" – coil.

### To assign secondary structure:

- Load the pdb structure (File/Open or PDB Search)
- Select the structure. You can do this by double clicking on the name of the structure in the ICM Workspace (a selection is highlighted blue in the ICM Workspace and green crosses in the graphical display) or you can use the right-click button and drag it over the whole structure in the graphical display.
- Tools/3D Predict/Assign helices and Strands

## 11.2 Protein Health

### Theory

The protein health option calculates the energy strain of a structure in ICM. It is generally a good idea to investigate the energy strain of any protein structure before undertaking such processes as docking. It is also essential to use this tool after making a model (see Molecular Modeling) to identify strained regions within your model and then some optimization procedure can be undertaken to rectify the problems.

The protein health option calculates the relative energy of each residue for a selection and colors the selected residues by strain.

This macro uses statistics obtained in the following paper Maierov, V.N. and Abagyan, R.A. (1998) Energy strain in three-dimensional protein structures *Folding and Design*, 3, 259–269.

To use the Protein Health option your structure must be converted into an ICM object (see *Converting to ICM Object*)

Next, make a selection of which residues you wish to analyze (see *Making Selections*).

- Tools/3D Predict/Protein Health and a window as shown below will be displayed.

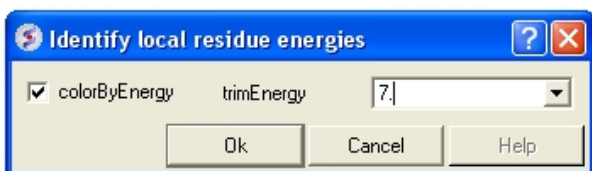

- The scale of the coloring can be changed by altering the value within the trimEnergy data entry box.

- Click OK and the structure will be colored according to energy strain (red – high) and a table of residue energy will be displayed in a table.
- To reactivate the screen click the Go button in the bottom left hand corner of the GUI display.

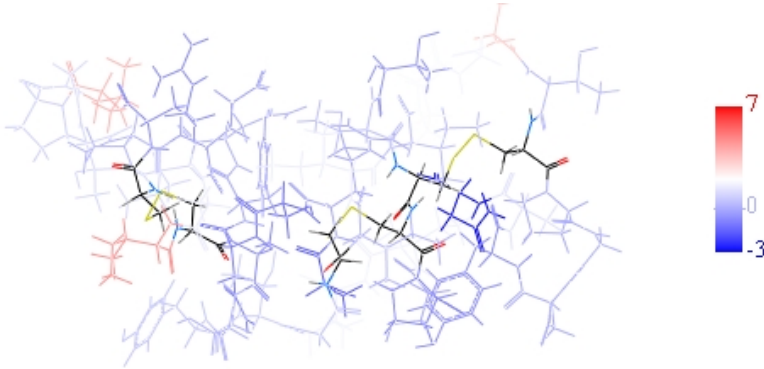

The Protein Health option returns a table of energies for each amino acid in the selection:

ENERGY_STRAIN										
	i	Sel	Res	sec_str	NormEnergy	BondsAngles	Bonds	Angles	Phi	Psi
1	22	1cm.m/25	ile	H	4.55	16.51	2.07	14.44	-75.00	-38.00
2	15	1cm.m/18	leu	_	3.71	20.15	3.35	16.80	-53.00	-46.00
3	33	1cm.m/38	ala	_	3.14	9.13	0.36	8.77	-121.00	1.00
4	31	1cm.m/36	pro	_	1.92	7.75	3.26	4.49	116.00	-24.00
5	6	1cm.m/8	val	H	1.74	14.12	1.17	12.96	-56.00	-45.00
6	32	1cm.m/37	gly	_	1.71	8.43	1.16	7.27	-90.00	-162.00
7	5	1cm.m/7	ile	H	1.65	17.87	2.22	15.65	-64.00	-42.00
8	29	1cm.m/34	ile	E	1.59	16.16	1.87	14.29	-112.00	130.00
9	21	1cm.m/24	ala	H	1.46	9.84	1.24	8.60	-63.00	-35.00
10	39	1cm.m/45	ala	_	1.28	11.54	1.24	10.30	-89.00	-3.00
11	17	1cm.m/20	gly	_	1.08	5.11	0.40	4.72	106.00	7.00
12	13	1cm.m/15	val	H	1.04	13.13	1.01	12.12	-69.00	-41.00
13	18	1cm.m/21	thr	_	1.03	14.51	3.61	10.90	-53.00	136.00

The Protein Health option returns a plot of energies for each amino acid in the selection:

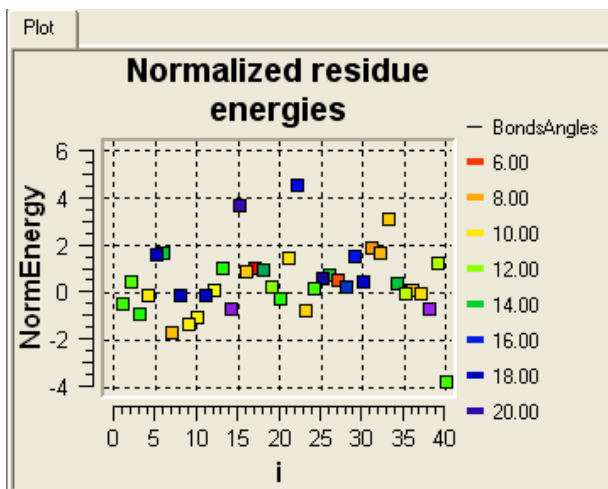

## 11.3 Local Flexibility

This option systematically samples rotamers for each residue side-chain in the input selection and uses resulting conformational ensembles to evaluate energy-weighted RMSDs for every side-chain atom. These are stored in the 'field' values on atoms and can be used for example to color the structure by side-chain flexibility. Conformational entropy for each residue side-chain is also calculated and stored in a table. If `_entropyBfactor` flag is on, the atom rmsds are normalized within the residue to reflect its total conformational entropy. If `_bfactor` flag is set, the bfactors are reset to the same values that are placed in the atom 'field', and occupancy is set to be inversely proportional to it ( $O=1/(1+2*rmsd)$ )

- Read pdb file (File/Open or PDB Search Tab).
- Convert to an ICM Object.
- Tools/3D Predict/Local Flexibility

## 11.4 Protein-Protein Interface Prediction

The ICM Optimal Docking Area method is a useful way of predicting likely protein-protein interaction interfaces. If you do not have mutational data or other experimental data which indicates the likely protein-protein docking site this method will be useful. This procedure can save you time during the docking procedure by focusing your docking only on areas on the receptor and ligand most likely to interact.

### *Theory*

**ODA** (Optimal Docking Areas) is a new method to predict protein-protein interaction sites on protein surfaces. It identifies optimal surface patches with the lowest docking desolvation energy values as calculated by atomic solvation parameters (ASP) derived from octanol/water transfer experiments and adjusted for protein-protein docking. The predictor has been benchmarked on 66 non-homologous unbound structures, and the identified interactions points (top 10 ODA hot-spots) are correctly located in 70% of the cases (80% if we disregard NMR structures). For a description of the method see *Fernandez-Recio et al Proteins (2005) 127: 9632*.

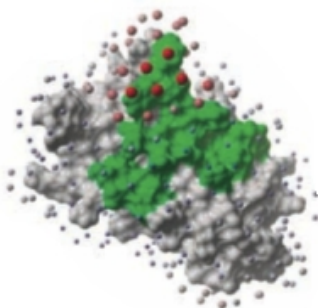

### *To display the optimal docking area.*

- Convert the PDB file to an ICM object.
- Tools/3D Predict/Protein Interface by ODA
- If you select the **Residue Table** option the average ODA score for each residue will be displayed in a table. The lower the number the higher the chance the residue will be involved in protein-protein interactions. Regions colored red represent low ODA score and blue represents a high score.

### *ODA Example with a subtilisin-chymotrypsin complex.*

As an example we will determine whether the ICM-ODA method can accurately predict the binding surface of the complex between subtilisin and chymotrypsin. This example is used in the protein-protein docking tutorial below as well.

This complex has been solved experimentally and has PDB id 2sni.

Calculate the ODA for each subunit (Tools/3D Predict / Protein Interface by ODA).

ODA for subtilisin and ODA for chymotrypsin – red colored spheres indicate a region highly likely to be involved in protein–protein interaction, blue coloring is unlikely to be involved in protein–protein interaction. A clickable table is also displayed with ODA values.

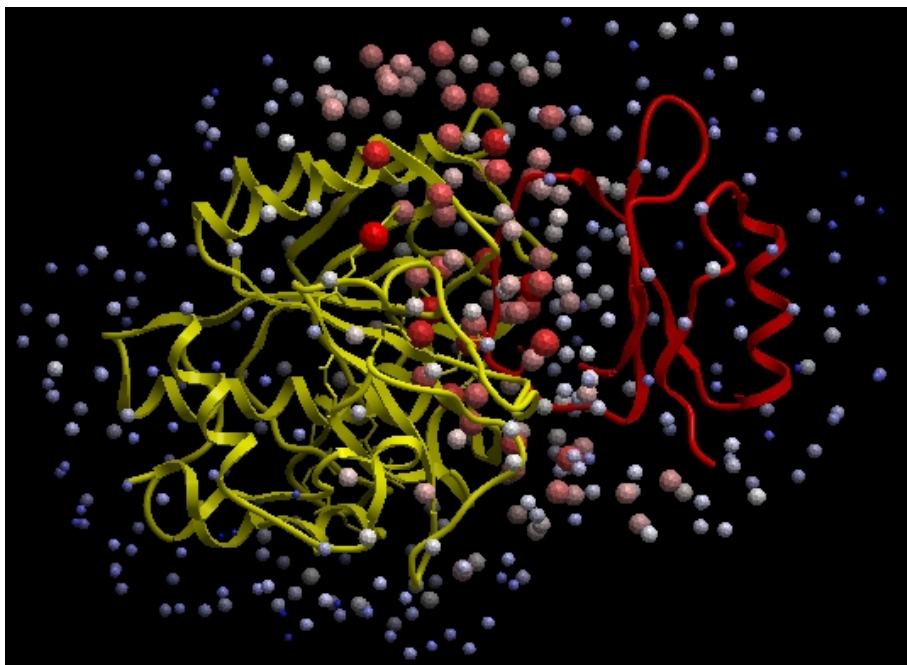

## 11.5 Identify Ligand Pockets

If a binding pocket is not known in advance, use `icmPocketFinder` or `icmCavityFinder` (for closed pockets). The protein needs to be converted to an ICM object in order to use `icmPocketFinder`.

`icmPocketFinder` can be accessed by

- Click on the menu **Tools/3D Predict/icmPocketFinder**

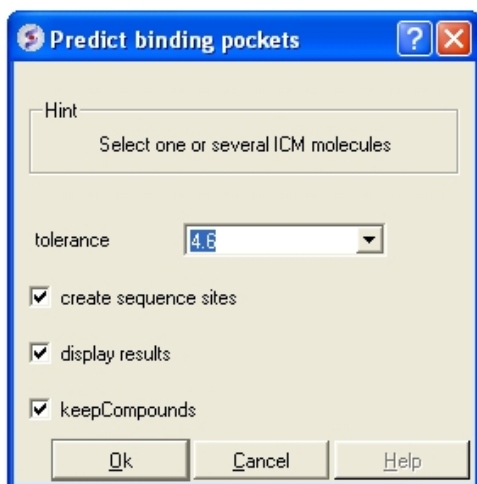

- Enter a tolerance level (4.6 is the default value and we recommended you to use this). The lower the tolerance value the more pockets predicted and the higher the tolerance the less pockets predicted.
- Check the box **create sequence sites** if you wish the site to be labeled.
- Check the box **display results** to see the predicted pockets as grobs in the display panel.
- Check the box **keep compounds** if you wish the compounds (ligands) in the receptor to be included in the prediction. If you don't check this box the pockets will be calculated based on the receptor without ligands.



- Click OK to run icmPocketFinder

**NOTE:** A button for icmPocketFinder can be found on the Setup Receptor option in the docking menu. It performs the same function as **Tools/3D Predict/icmPocketFinder**

The results from icmPocketFinder will be displayed in a table.

POCKETS								
	i	Volume	Area	Radius	Nonsphericity	Conservation	RelCons	Type
1	1	280.51	289.89	4.06	1.40	0.00	0.00	g_pocket1 a_1q61.a/28:31,48,50,65:66,68:70,72:73,148,169:170,18
2	2	170.17	189.65	3.44	1.28	0.00	0.00	g_pocket2 a_1q61.a/179,192:193,196,203:207,209,270:273
3	3	136.58	186.66	3.19	1.46	0.00	0.00	g_pocket3 a_1q61.a/16,27:32,34,49,51,54:55,98
4	4	126.19	179.85	3.11	1.48	0.00	0.00	g_pocket4 a_1q61.a/220,226:230,240,245:247,249,252:253
5	6	119.99	150.91	3.06	1.28	0.00	0.00	g_pocket6 a_1q61.a/112,115:116,119,188:189,221,225:227,230
6	5	117.19	152.31	3.04	1.32	0.00	0.00	g_pocket5 a_1q61.a/25,35,105:107,109:110,113)a_1q61.2

Additional information regarding the pocket

Click anywhere in the table to display the pocket in the graphical display

Residues surrounding predicted pocket

*To view the pocket in the graphical display:*

- Click on the pocket in the table or select the pocket from the meshes section of the ICM workspace. Right click on the pocket mesh in the ICM Workspace to retrieve more display options.

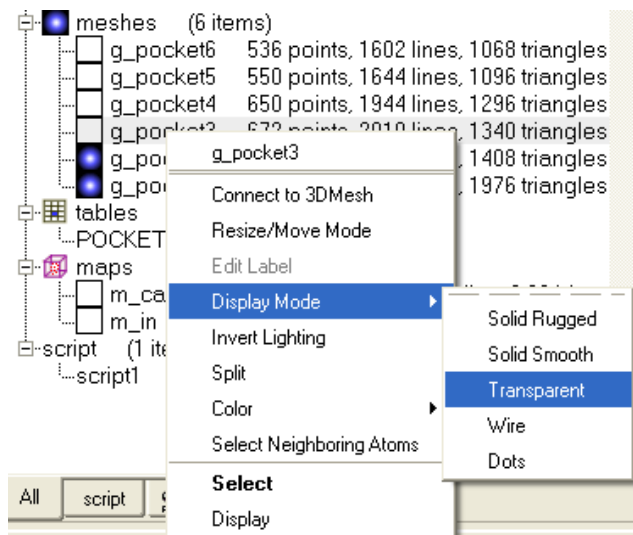

**Right click on the mesh in the ICM workspace to retrieve more display options**

The results from icmPocketFinder are also plotted graphically (Area vs Volume). A blue square highlights potential drug binding pockets based on typical area and volume values – this is only a guide on what constitutes a pocket likely to be involved in ligand binding. Selections can also be made from the plot by clicking and dragging around a point in the graph.

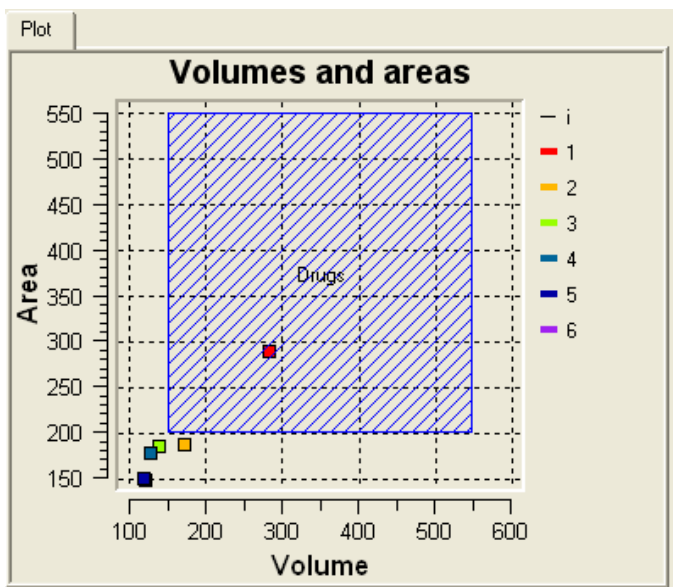

***To identify ligand binding pockets which are completely enclosed in the receptor:***

- Click on the menu Tools/Analysis/Closed Cavities and a window as shown below will be displayed.

A similar output to that generated by ICMPocketFinder will be displayed. This output includes a plot and a table. By clicking on the table or plot graphical selections can be made.





# 12 Cheminformatics

**Note:** Click **Next** (top right hand corner) to navigate through this chapter or use the links below. Headings are listed on the left hand side (web version) or by clicking the **Contents** button on the left-hand-side of the help window in the graphical user interface.

The cheminformatics tools provide an environment in which chemicals can be constructed, manipulated, stored and analyzed in one easy to use graphical interface.

**Some of the features include:**

## Chemical Drawing

- Draw compounds using an easy-to-use molecular editor
- Keyboard shortcuts for fast molecule sketching
- Large selection of annotated templates
- Full support for smiles and smarts
- Automated 2D drawing from 0D or 3D sdf files
- Draw compounds whilst monitoring key properties (eg Log P, drug-likeness etc..)
- Save files in mol, sdf and smiles format.

ICM Molecule Editor [new file \*]

File Edit View Templates Help

Large selection of template structures

Define stereochemistry

Linked to chemical searching tools

Save molecule in Mol/SDF format

Convert to 3D

Directly linked to 3D display and chemical spreadsheets

Name	Value
1 MolWeight	180.04
2 HBA	4
3 HBD	1
4 RotB	3
5 DrugLikeness	0.84
6 MolHf	-146.13
7 MolLogP	1.18
8 MolLogS	-1.65
9 MolPSA	49.48
10 Volume	168.04
11 Formula	C9H8O4
12 Smiles	CC(=O)Oc1ccc
13 Bad Groups	

Draw molecules or use Smarts/Smiles









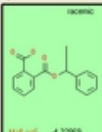
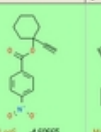

Draw pharmacophore

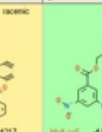
Monitor 'drug-likeness' of compound

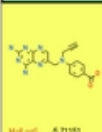
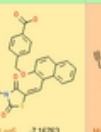
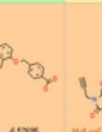
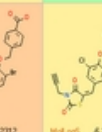
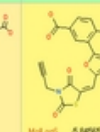
Add your own properties to monitor

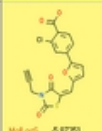
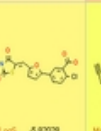
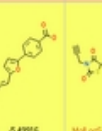
## Chemical Display

- Chemical spreadsheets – molecular tables – add columns, predict properties, annotate, edit
- 3D Browsing – quickly browse through a collection of 3D structures
- Browse and Lock – lock compounds in 3D display
- Highlight substructure – color chemical drawings by substructure
- Color by properties – color chemical drawings by properties

Chemical_spreadsheet						
	1	2	3	4	5	6
0	 MolLogP: 4.32669 MolLogP: 3.28512 MolHbngh: 266.263	 MolLogP: 4.69605 MolLogP: 3.22284 MolHbngh: 273.281	 MolLogP: -4.11221 MolLogP: 3.4987 MolHbngh: 226.294	 MolLogP: 7.34217 MolLogP: 4.14372 MolHbngh: 422.495	 MolLogP: 4.9823 MolLogP: 2.77245 MolHbngh: 305.277	 MolLogP: -2.4371 MolLogP: 1.97276 MolHbngh: 174.201
6	 MolLogP: 5.71951 MolLogP: 6.982029 MolHbngh: 345.955	 MolLogP: 7.16763 MolLogP: 5.09179 MolHbngh: 443.482	 MolLogP: 6.57695 MolLogP: 4.62953 MolHbngh: 472.317	 MolLogP: 4.62312 MolLogP: 4.62953 MolHbngh: 472.317	 MolLogP: 6.2196 MolLogP: 4.44414 MolHbngh: 427.866	 MolLogP: 5.84605 MolLogP: 3.91669 MolHbngh: 367.801
12	 MolLogP: 5.87261 MolLogP: 3.91669 MolHbngh: 367.801	 MolLogP: 5.83028 MolLogP: 3.91669 MolHbngh: 367.801	 MolLogP: 5.49916 MolLogP: 3.91638 MolHbngh: 353.256	 MolLogP: 5.42064 MolLogP: 3.91638 MolHbngh: 353.256	 MolLogP: -3.81396 MolLogP: 2.18476 MolHbngh: 307.296	 MolLogP: 5.79425 MolLogP: 3.90985 MolHbngh: 363.421

### 3D Chemistry

- Convert chemicals to 3D using the Merck Molecular Force Field (MMFF)
- Generate stereoisomers
- Generate tautomers
- Easy modification of a ligand in a 3D protein structure.
- Chemical superposition
- Flexible compound 3D overlay

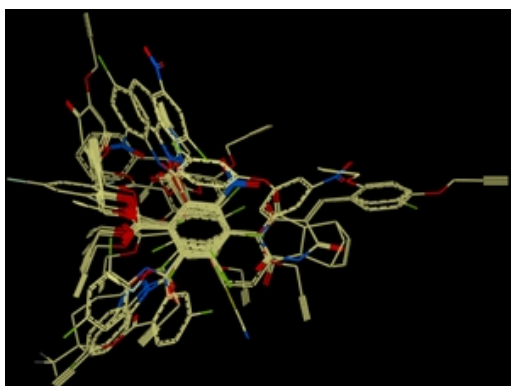

### Chemical Searching

- Chemical similarity searching – substructure, fingerprint similarity and exact match
- Search local tables (SDF, Mol Files) or MolCart
- Pharmacophore searching in conformer databases or files
- 2D pharmacophore searching in compound databases

MolCart Databases Draw query structure or use Smiles Substructure, fingerprint and exact match searching

ICM Chemical Search: connected as molcart@samba

Name	Value
MolWeight	263.11
HBA	3
ABD	1
RuB	4
DrugLiassess	10.88
MuBt	31.28
MolLogP	2.29
MolLogS	-4.30
MolPSA	41.02
Volume	248.70
Formula	C16 H13 N1 O
Smiles	CN(C)C(=O)c1ccc2c(c1)ncn2

Field/Name	Relation	Value
AllVendors vendors	AND	chemdiv
AllVendors modl	AND	300

```

icm/pep> as_graph = : as
icm/pep> unds as_graph
icm/pep> find molcart sstructure "ClC=CC=CC=1" table="screenpub.AllVendors" number=1000 name="result"
Info> 1000 elements stored into table 'result'
  
```

Command line for scripting searches      Text and field searching      Make your own databases

## Library Generation

- Virtual chemistry library generation using reactions
- Conformation generator
- Split into fragments to generate a series of R groups.
- Find and replace chemical editing
- Focused library generation
- Structure-based and ligand-based virtual screening using MolCart

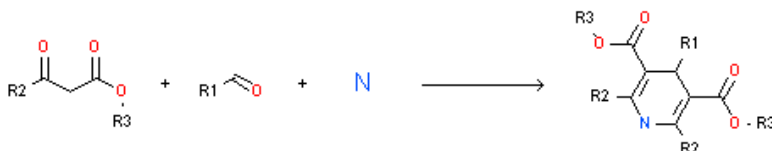

## Chemical clustering

- Fast chemical clustering with a variety of Linkage Types
- Extract representative "center" structures from each node.
- Branch reordering and distance changing

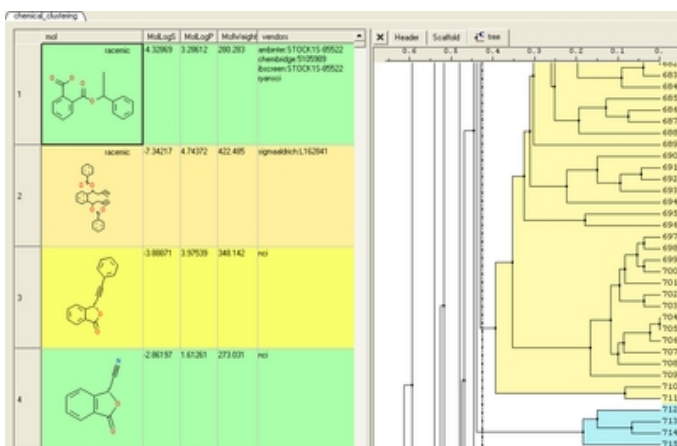

## QSAR

- Predict compound properties – LogP, LogS, PSA, hERG, aggregation, CYP3A4, druglikeness, reactive chemical groups, Heats of Formation, Lipinski, etc..
- Various methods for linear and non-linear QSAR including, both regression and classification methods PLS, pcR and PC regression methods

- PC regression or classification with the following kernels radial, scalar products, polynomial, sigmoid and tanimoto
- Cross validation and boot–strapping
- Save models and data plotting

## 12.1 Reading Chemical Structures

Chemical structures can be read into ICM from MOL/MOL2, SMILES, and SDF files OR you can construct your own structures by drawing them in the ICM molecular editor.

### 12.1.1 Loading Chemical Structures

*Chemical structures from pre-existing molecular files such as MOL, MOL2 or SDF can be read into ICM by:*

- Select File/Open and the window as shown below will be displayed.
- Select the chemical structure file you wish to open: MOL, MOL2 or SDF
- Once selected the file will be displayed as a chemical table (See ICM molecular tables section).

The screenshot shows the ICM software interface. A 'File/Open' dialog box is open, displaying a file list with 'substructure.mol' and 'substructure.sdf' selected. A callout box labeled '1. File/Open' points to the menu item. Another callout box labeled '2. Locate file' points to the file list. To the right, a 3D ball-and-stick model of a chemical structure is shown. At the bottom, a chemical table is visible with columns for 'mol', 'molweight', 'mol\_clogp', 'mol\_logp', 'mol\_psa', and 'mol\_molwt'. A callout box at the bottom right states: '• SDF and mol files will open in chemical spreadsheet format. • Mol2 will open up in the graphical display.'

### 12.1.2 Chemical Smiles

If you know the chemical smiles string for the compound you can build it by:

- Select **File/New**.
- Click the **Compound** tab at the top of the window.
- Enter a name for the compound.
- Type in the **Smiles String** in the Smiles String data entry box. Remember to delete the previous string.
- Check the boxes Display Molecule Delete Other Objects according to your preference.
- Click the OK button.

Smiles can be read from a text file into a chemical table by:



- **File/Open** and select **Files of type:** Smiles format

Smiles can be read directly into the ICM Molecular Editor:

- Open the ICM Molecular Editor window.
- Select **Edit/Add Smiles**

## 12.2 Working with Chemical Spreadsheets.

When an sdf file is read into ICM it is displayed as a chemical spreadsheet. Many of the operations you can perform on chemical spreadsheets (Molecular Tables) are described in the table section of this manual. Some useful chemical-only options are described in this section.

An example of an ICM molecular table:

The screenshot displays the ICM Molecular Table interface. At the top, there are tabs for 'Lead\_Compounds' and 'Herg'. A right-click context menu is open over the first row of the table. The table has columns for 'mol', 'MolWeight', 'MolFormula', 'Nof\_RotBonds', and 'vendors'. The first row shows a chemical structure, 'racemic', '471.564', 'C31H25N3O2', '8', and 'ufark:24693'. The second row shows a chemical structure, 'racemic', '2', and 'ufark:24692'. The third row shows a chemical structure, 'racemic', '3', and 'ufark:14690'. The context menu includes options like 'Edit Cells by Double-click', 'Find in Table', 'Color By', 'Clustering...', 'Learn...', 'Analysis', 'Row Selection', 'Insert Row', 'Delete Row', 'Copy Molecule Image', 'Copy Molecule Image To Album', 'Save Molecule As Image...', 'Edit Molecule...', 'Query Molecule', 'Chemistry', 'Cell mol[5]', 'Mark Row', 'Selecte Marked Rows', 'Copy Molecule', 'Paste', and 'Print Table...'. Annotations include: 'Table tab' pointing to the 'Lead\_Compounds' tab; 'Multiple tables' pointing to the 'Herg' tab; 'Add new fields - calculate and predict properties' pointing to the menu; 'Select rows - use CTRL button (non-contiguous) or Shift button (range)' pointing to the row numbers; '2D Sketch' pointing to the chemical structure in the first row; and 'Edit text' pointing to the 'vendors' cell.

### 12.2.1 Molecular Table Display

There are many ways in which a molecular table can be displayed. For example you can select whether you want to have just the structure displayed or maybe you want to display the structure with a lot of other important information such as molecular weight, docking score, energy etc...

The default layout displays all the columns and tables. However using the table selection tools described in the previous section **Standard ICM Table** you can customize the display.

- First select which columns you wish to display.

	mol	MOLNAME	RNEXTREG	MOL_WEIGHT	UPD_CODE
1	chiral 	(-)-GMC-1111	DR0052493	289.44	2001.3-2001.3
2		1,2-NAPHTHOQUINONE	NAPHQUI12	158.16	1990.1-1990.1
3	chiral 	1-RV-96-A	DR0014370	381.57	2001.1-2001.3

table: 1067 rows, 26 columns

Next,

- Right click on the selection and the following menu will be displayed

```
icm/def> add column
Info> 1 column
icm/def>
```

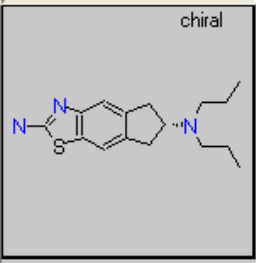
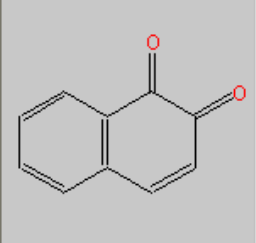
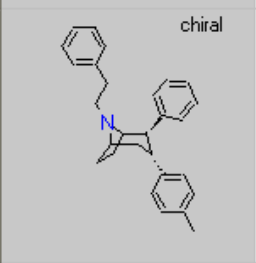
The screenshot shows a chemical spreadsheet with three rows of chemical structures. The first row contains a molecule with a benzene ring, a chlorine atom, and a nitroso group. The second row contains a molecule with a benzene ring, a nitroso group, and an allyloxy group. The third row contains a molecule with a benzene ring, a chlorine atom, a nitroso group, and an allyloxy group. A context menu is open over the table, listing various actions like 'Table View', 'Find in Selected Columns', 'Color By', 'Clustering...', 'Learn...', 'Analysis', 'Row Selection', 'Insert Row', 'Delete Row', 'Copy Molecule Image', 'Copy Molecule Image To Album', 'Save Molecule As EPS...', 'Save Molecule As Image...', 'Edit Molecule...', 'Edit DB Record...', 'Query Molecule', 'Chemistry', 'Cell MolWeight[3]', 'Copy Columns(s)', 'Paste Column(s)', and 'Print Table...'.

- Select Table View and either grid view or custom grid..

The screenshot shows the 'Table View' context menu with a sub-menu open. The sub-menu options are: 'Show Extra Panel', 'Show Chemical Properties', 'Fit to Screen', 'Grid View Ctrl+T (Toggle)', 'Custom Grid..', 'Cursor Action', and 'Show Grid Lines'. The 'Cursor Action' and 'Show Grid Lines' options are checked.

- If you select "custom grid" you will be asked the number of columns you wish to display in a grid view (eg 5 column grid view is shown below).

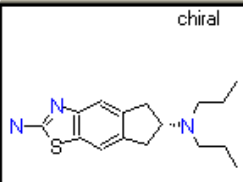
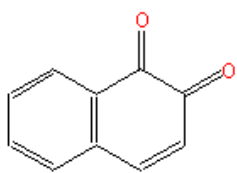
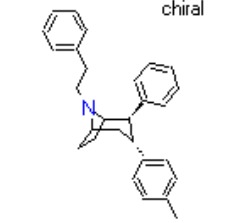
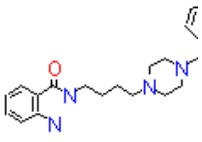
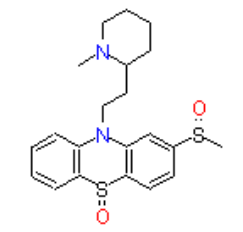
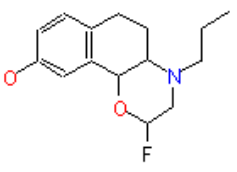
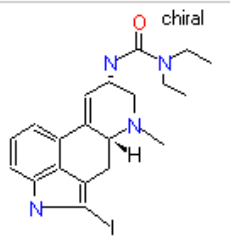
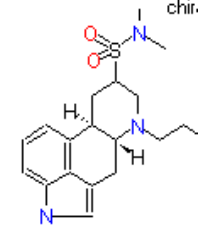
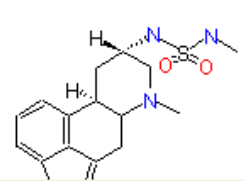
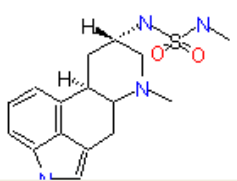
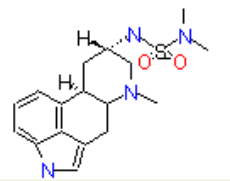
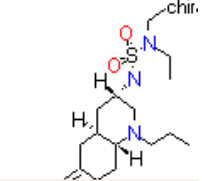
	1	2	3	4
0	<p>chiral</p>  <p>MF C16 H23 I MOL_WEIGHT 289.44</p>	 <p>MF C10 H6 O MOL_WEIGHT 158.16</p>	<p>chiral</p>  <p>MF C28 H31 I MOL_WEIGHT 381.57</p>	 <p>MF C22 H MOL_WEIGHT 409.56</p>
5	 <p>MF C21 H26 I MOL_WEIGHT 402.58</p>	 <p>MF C15 H20 I MOL_WEIGHT 265.32</p>	<p>chiral</p>  <p>MF C20 H25 I MOL_WEIGHT 464.34</p>	<p>chir.</p>  <p>MF C19 H MOL_WEIGHT 361.51</p>
10				<p>chir.</p> 

## 12.2.2 How to add columns into a chemical spreadsheet.

How to add columns into a chemical spreadsheet.

1. Right click on a column header and select "insert column".

2. Click the main type of argument you want to add. E.g. mol for chemical functions.

3. Press the "Add To List" button

4. Select the argument (s)

Function	Name	Category	Description
<input type="checkbox"/> Mol_Availability	molAvail	Chemical	Molecular weight
<input type="checkbox"/> Mol_Formula	molFormula	Chemical	Chemical formula e.g. C2H6O
<input type="checkbox"/> Mol_IupacName	molIupacName	Chemical	IUPAC nomenclature name
<input type="checkbox"/> Mol_LogP	molLogP	Chemical	Octanol/water partition, LogP <sub>ow</sub> C
<input type="checkbox"/> Mol_LogS	molLogS	Chemical	Water solubility LogS <sub>ow</sub> (KOW)
<input type="checkbox"/> Mol_PolarArea	molPolarArea	Chemical	Polar surface area
<input type="checkbox"/> Mol_Volume	molVolume	Chemical	Molecular volume
<input type="checkbox"/> Mol_Wt	molWt	Chemical	Weight of formation from elements
<input type="checkbox"/> Drug_Accessible	drugAccessible	Chemical	Empirical fragment
<input type="checkbox"/> Smiles_Smarts	smiles	Chemical	SMILES/SMARTS string notation s...
<input type="checkbox"/> BadGroup	badGroup	Chemical	Unwanted or reactive chemical func...
<input type="checkbox"/> Mol_Atoms	molAtoms	Chemical	Number of atoms
<input type="checkbox"/> Mol_Molecules	molMolecules	Chemical	Number of individual molecules
<input type="checkbox"/> Mol_Fragments	molFragments	Chemical	Number of SMARTS pattern occur...
<input type="checkbox"/> Mol_Chiral	molChiral	Chemical	Number of chiral centers, R/S or (R/S)
<input type="checkbox"/> Mol_Booster	molBooster	Pharmacol	Number of boosters in the C11DB

### 12.2.3 How to sort a column(s) in a chemical spreadsheet.

How to sort a column(s) in a chemical spreadsheet.

1. Right click on a column header and select "Sort"

NAME	molwt	mollogp	mollogS	molPolarArea	molVolume	molWt	drugAccessible	smiles	badGroup	molAtoms	molMolecules	molFragments	molChiral	molBooster
C13H12N2O	164930	2.141	2.626	-3.869	28.13	C1C=NC=C1C(=O)C=C1C(=O)C=C1	2							
C13H12N2O	159872	2.121	1.912	-3.61	27.46	C1C=NC=C1C(=O)C=C1C(=O)C=C1	1							
C13H14N2O	158405	2.141	1.896	-3.397	28.48	NC1=NC(=O)C=C1C(=O)C=C1	2							
C13H14N2O	164821	2.141	2.626	-3.869	28.13	C1C=NC=C1C(=O)C=C1C(=O)C=C1	2							

## 12.2.4 How to change the view of a chemical spreadsheet – form, table and grid.

The screenshot shows the Molsoft Chem3D 3.6.1g interface with a chemical spreadsheet. The spreadsheet has columns for NAME, molwt, and several numerical columns. A context menu is open over the spreadsheet, showing options like 'Table View', 'Form View', and 'Grid View'. Callout boxes provide instructions on how to change the view.

**1.** For grid view select the columns you wish to display in the grid. Click on the column header to select (click and hold CTRL key for non-contiguous selections or SHIFT key for range)

**2a.** Right click anywhere on the spreadsheet and select "Table View"

**2b.** Or you can use the buttons here.

How to change the view of a chemical spreadsheet – form, table and grid.

## 12.2.5 How to copy, cut and paste columns and rows in a chemical spreadsheet.

The screenshot shows the Molsoft Chem3D 3.6.1g interface with a chemical spreadsheet. The spreadsheet has columns for NAME, molwt, and several numerical columns. Callout boxes provide instructions on how to copy, cut, and paste columns and rows.

**1.** Select a column or row by clicking on the header. (click and hold CTRL key for non-contiguous selections or SHIFT key for range)

**2a.** To copy, cut and paste rows – right click here on a selected row(s)

**2b.** To copy, cut and paste rows – right click here on a selected column(s)

How to copy, cut, and paste columns and rows in a chemical spreadsheet.

## 12.2.6 How to show and hide columns and rows in a chemical spreadsheet.

**How to hide rows in a chemical spreadsheet.**

1. Select row(s) (click and hold CTRL key for non-contiguous selections or SHIFT key for range)

2. Right click here and select "Hide Rows"

**How to hide columns in a chemical spreadsheet.**

1. Select column(s) (click and hold CTRL key for non-contiguous selections or SHIFT key for range)

2. Right click here and select "Hide Column(s)"

NAME	molwt	molVol	molSA	molTP	molTP	molTP	molTP	molTP	molTP
C13H9N2O	202.19	172.1	1.511	-2.521	28.11	NC1=CC=C(OH)C=C1	CC1	2	
C13H9N2O	202.19	172.1	1.511	-2.521	28.11	NC1=CC=C(O)C=C1	CC1	2	
C13H9N2O	202.19	172.1	1.511	-2.521	28.11	NC1=CC=C(O)C=C1	CC1	2	
C13H9N2O	202.19	172.1	1.511	-2.521	28.11	NC1=CC=C(O)C=C1	CC1	2	
C13H9N2O	202.19	172.1	1.511	-2.521	28.11	NC1=CC=C(O)C=C1	CC1	2	
C13H9N2O	202.19	172.1	1.511	-2.521	28.11	NC1=CC=C(O)C=C1	CC1	2	
C13H9N2O	202.19	172.1	1.511	-2.521	28.11	NC1=CC=C(O)C=C1	CC1	2	
C13H9N2O	202.19	172.1	1.511	-2.521	28.11	NC1=CC=C(O)C=C1	CC1	2	
C13H9N2O	202.19	172.1	1.511	-2.521	28.11	NC1=CC=C(O)C=C1	CC1	2	
C13H9N2O	202.19	172.1	1.511	-2.521	28.11	NC1=CC=C(O)C=C1	CC1	2	

## 12.2.7 How to save a chemical spreadsheet in sdf format.

How to save a chemical spreadsheet in sdf format.

1. Right click on the spreadsheet header tab

2. Select "Save As.."

NAME	molwt	mollogp	molhba	molqed	molqed	molqed	molqed
C13H12N2	202.96	172.1	1.91	-0.57	28.11	NC1=CC=C(O)C=C1C1=CC=C1	2
C13H12N2	184.90	200.1	1.62	-0.24	28.13	C1=CC=C(C=C1)C1=CC=C1C1=CC=C1	2
C13H12N2	198.02	212.1	1.92	-0.61	27.46	C1=CC=C(C=C1)C1=CC=C1C1=CC=C1	1
C13H14N2	158.45	214.1	1.86	-0.37	28.48	NC1=CC=C(C=C1)C1=CC=C1	2
C13H14N2	184.01	214.1	2.02	-0.60	28.13	C1=CC=C(C=C1)C1=CC=C1C1=CC=C1	2

## 12.2.8 How to export your chemical spreadsheet into Excel.

How to export a chemical spreadsheet into Excel.

1. Right click on the spreadsheet header tab

2. Select "Export To Excel"

NAME	molwt	mollogp	molhba	molqed	molqed	molqed	molqed
C13H12N2	202.96	172.1	1.91	-0.57	28.11	NC1=CC=C(O)C=C1C1=CC=C1	2
C13H12N2	184.90	200.1	1.62	-0.24	28.13	C1=CC=C(C=C1)C1=CC=C1C1=CC=C1	2
C13H12N2	198.02	212.1	1.92	-0.61	27.46	C1=CC=C(C=C1)C1=CC=C1C1=CC=C1	1
C13H14N2	158.45	214.1	1.86	-0.37	28.48	NC1=CC=C(C=C1)C1=CC=C1	2
C13H14N2	184.01	214.1	2.02	-0.60	28.13	C1=CC=C(C=C1)C1=CC=C1C1=CC=C1	2



## 12.2.9 How to print a chemical spreadsheet.

How to print a chemical spreadsheet.

1. Right click on the spreadsheet header tab

2. Select "Print Table"

NAME	molwt	molHeight	molLogP	molLogD	molPSA	molclogP	molclogD
C13H20N2O	202196	172.1	1.911	-0.921	28.11	NC1=CC=C(C=C1)C(=O)CC1=CC=C1	2
C13H20N2O	168490	200.1	1.625	-0.214	28.13	C1=CC=C(C=C1)C(=O)CC1=CC=C1	2
C13H20N2O	98002	212.1	1.912	-0.61	27.46	C1=CC=C(C=C1)C(=O)CC1=CC=C1	1
C13H20N2O	103405	214.1	1.896	-0.307	28.48	NC1=CC=C(C=C1)C(=O)CC1=CC=C1	2
C13H20N2O	168401	214.1	2.026	-0.680	28.13	C1=CC=C(C=C1)C(=O)CC1=CC=C1	2

## 12.2.10 How to filter columns in a chemical spreadsheet.

How to filter columns in a chemical spreadsheet (1).

1. Right click on the column header you wish to filter

2. Select Filter Custom or Filter From List...

mol	molwt	molHeight	molLogP	molLogD	molPSA	molclogP	molclogD
6.376	300	1.925	-4.688	52.156	202.2	96.4	0.0917
6.525	373.1	4.258	5.809	42.152	268.4	79.3	0.0377
6.6	317	2.206	-4.619	42.16	268.4	99.36	0.129
6.676	339	2.759	-5.176	42.62	268.4	99.36	0.2019

How to filter columns in a chemical spreadsheet (2).

2. This symbol indicates the column is filtered

1. Enter filters

To remove a filter right click on the column that is filtered and select Filter/Clear

### 12.2.11 How to use find and replace in a chemical spreadsheet.

How to use find and replace in a chemical spreadsheet.

1. Right click on the mol column

2. Select Chemical Find and Replace

3. Use the editor to sketch the group you want to find

4. Use the editor to sketch the group you want to replace with

You can also do text find and replace by right clicking anywhere on the table and select Find and Replace.

## 12.2.12 How to mark and label rows in a chemical spreadsheet.

How to mark and label rows in a chemical spreadsheet.

1. Select the row(s) you wish to label by clicking on the row number. Click and hold CTRL key for non-contiguous selections or SHIFT key for range.
2. Right click on the selected row and choose "Mark Selected Rows" Select a color label.
3. You can select marked (labeled) rows here.

## 12.2.13 How to insert hyperlinks to the PDB, PubMed, and Uniprot.

How to insert hyperlinks.

1. Right click on the column header and select "Format"
2. Choose hyperlink type here
3. Click OK and the hyperlink will be generated

## 12.2.14 How to copy and paste 2D chemicals.

How to copy and paste 2D chemicals.

1. Right click on the 2D chemical.

2. Select "Copy 2D Molecule"

mol	molwt	molheight	molLogP	molLogS	molPSA	molVolume	molBP	fragAreness	molHBA	molHBD	job
1	6	471	4.775	-7.136	42.74	336	134.4	0.05017	3	3	12abc
2	6	393.1	3.924	-6.126	42.74	314	126.1	0.07969	3	3	12abc
3	6	311	1.376	-5.533	53.62	183.3	98.27	0.3593	3	3	23abc
4	6	303	1.925	-4.866	52.56	222.2	96.47	0.007176	3	3	25abc
5	6	311	4.295	-6.889	42.92	310.4	79.3	0.6937	3	3	15abc
6	6	317	2.206	-6.619	43.16	260.4	99.96	0.129	3	3	15abc
7	6	447.5	3.21	-7.259	42.63	280.4	95.96	0.2819	3	3	12abc

## 12.2.15 How to edit data inside a chemical spreadsheet.

How to edit data inside a chemical spreadsheet.

1. Click here

2. Edit data by double clicking on the data.

mol	molwt	molheight	molLogP	molLogS	molPSA	molVolume	molBP	fragAreness	molHBA	molHBD	job
1	6	471	4.775	-7.136	42.74	336	134.4	0.05017	3	3	12abc
2	6	393.1	3.924	-6.126	42.74	314	126.1	0.07969	3	3	12abc
3	6	311	1.376	-5.533	53.62	183.3	98.27	0.3593	3	3	23abc
4	6	303	1.925	-4.866	52.56	222.2	96.47	0.007176	3	3	25abc
5	6	311	4.295	-6.889	42.92	310.4	79.3	0.6937	3	3	15abc
6	6	317	2.206	-6.619	43.16	260.4	99.96	0.129	3	3	15abc
7	6	447.5	3.21	-7.259	42.63	280.4	95.96	0.2819	3	3	12abc

## 12.2.16 How to remove salts, explicit hydrogens and standardize chemical groups.

How to remove salts, explicit hydrogens and standardize chemical groups.

1. Chemistry/Standardize

2. Select here

3. Select Files tab for batch mode

The screenshot shows the Chem3D interface with a spreadsheet of chemical structures. A 'Standardize' dialog box is open, showing the 'Files' tab. The 'Molecule Table' is set to 'binding\_data'. Under 'Options', the checkboxes for 'Remove Salts', 'Standardize Groups', and 'Remove Explicit Hydrogens' are checked. The 'Files' tab is selected, and the 'Standardize' button is highlighted.

## 12.2.17 How to calculate chemical properties in a chemical spreadsheet.

How to calculate chemical properties in a spreadsheet.

1. Chemistry/Calculate Properties

2. Select properties

3. Properties will be displayed in new columns

The screenshot shows the Chem3D interface with a spreadsheet of chemical structures. A 'Calculate Chemical Properties' dialog box is open. The 'Function' dropdown is set to 'Multiple Functions'. The 'New column location' is set to 'end'. The 'New column name' is set to 'end'. The 'Add To List' button is highlighted. The 'Properties' list includes: MW, MW0, MW1, MW2, MW3, MW4, MW5, MW6, MW7, MW8, MW9, MW10, MW11, MW12, MW13, MW14, MW15, MW16, MW17, MW18, MW19, MW20, MW21, MW22, MW23, MW24, MW25, MW26, MW27, MW28, MW29, MW30, MW31, MW32, MW33, MW34, MW35, MW36, MW37, MW38, MW39, MW40, MW41, MW42, MW43, MW44, MW45, MW46, MW47, MW48, MW49, MW50, MW51, MW52, MW53, MW54, MW55, MW56, MW57, MW58, MW59, MW60, MW61, MW62, MW63, MW64, MW65, MW66, MW67, MW68, MW69, MW70, MW71, MW72, MW73, MW74, MW75, MW76, MW77, MW78, MW79, MW80, MW81, MW82, MW83, MW84, MW85, MW86, MW87, MW88, MW89, MW90, MW91, MW92, MW93, MW94, MW95, MW96, MW97, MW98, MW99, MW100, MW101, MW102, MW103, MW104, MW105, MW106, MW107, MW108, MW109, MW110, MW111, MW112, MW113, MW114, MW115, MW116, MW117, MW118, MW119, MW120, MW121, MW122, MW123, MW124, MW125, MW126, MW127, MW128, MW129, MW130, MW131, MW132, MW133, MW134, MW135, MW136, MW137, MW138, MW139, MW140, MW141, MW142, MW143, MW144, MW145, MW146, MW147, MW148, MW149, MW150, MW151, MW152, MW153, MW154, MW155, MW156, MW157, MW158, MW159, MW160, MW161, MW162, MW163, MW164, MW165, MW166, MW167, MW168, MW169, MW170, MW171, MW172, MW173, MW174, MW175, MW176, MW177, MW178, MW179, MW180, MW181, MW182, MW183, MW184, MW185, MW186, MW187, MW188, MW189, MW190, MW191, MW192, MW193, MW194, MW195, MW196, MW197, MW198, MW199, MW200, MW201, MW202, MW203, MW204, MW205, MW206, MW207, MW208, MW209, MW210, MW211, MW212, MW213, MW214, MW215, MW216, MW217, MW218, MW219, MW220, MW221, MW222, MW223, MW224, MW225, MW226, MW227, MW228, MW229, MW230, MW231, MW232, MW233, MW234, MW235, MW236, MW237, MW238, MW239, MW240, MW241, MW242, MW243, MW244, MW245, MW246, MW247, MW248, MW249, MW250, MW251, MW252, MW253, MW254, MW255, MW256, MW257, MW258, MW259, MW260, MW261, MW262, MW263, MW264, MW265, MW266, MW267, MW268, MW269, MW270, MW271, MW272, MW273, MW274, MW275, MW276, MW277, MW278, MW279, MW280, MW281, MW282, MW283, MW284, MW285, MW286, MW287, MW288, MW289, MW290, MW291, MW292, MW293, MW294, MW295, MW296, MW297, MW298, MW299, MW300, MW301, MW302, MW303, MW304, MW305, MW306, MW307, MW308, MW309, MW310, MW311, MW312, MW313, MW314, MW315, MW316, MW317, MW318, MW319, MW320, MW321, MW322, MW323, MW324, MW325, MW326, MW327, MW328, MW329, MW330, MW331, MW332, MW333, MW334, MW335, MW336, MW337, MW338, MW339, MW340, MW341, MW342, MW343, MW344, MW345, MW346, MW347, MW348, MW349, MW350, MW351, MW352, MW353, MW354, MW355, MW356, MW357, MW358, MW359, MW360, MW361, MW362, MW363, MW364, MW365, MW366, MW367, MW368, MW369, MW370, MW371, MW372, MW373, MW374, MW375, MW376, MW377, MW378, MW379, MW380, MW381, MW382, MW383, MW384, MW385, MW386, MW387, MW388, MW389, MW390, MW391, MW392, MW393, MW394, MW395, MW396, MW397, MW398, MW399, MW400, MW401, MW402, MW403, MW404, MW405, MW406, MW407, MW408, MW409, MW410, MW411, MW412, MW413, MW414, MW415, MW416, MW417, MW418, MW419, MW420, MW421, MW422, MW423, MW424, MW425, MW426, MW427, MW428, MW429, MW430, MW431, MW432, MW433, MW434, MW435, MW436, MW437, MW438, MW439, MW440, MW441, MW442, MW443, MW444, MW445, MW446, MW447, MW448, MW449, MW450, MW451, MW452, MW453, MW454, MW455, MW456, MW457, MW458, MW459, MW460, MW461, MW462, MW463, MW464, MW465, MW466, MW467, MW468, MW469, MW470, MW471, MW472, MW473, MW474, MW475, MW476, MW477, MW478, MW479, MW480, MW481, MW482, MW483, MW484, MW485, MW486, MW487, MW488, MW489, MW490, MW491, MW492, MW493, MW494, MW495, MW496, MW497, MW498, MW499, MW500, MW501, MW502, MW503, MW504, MW505, MW506, MW507, MW508, MW509, MW510, MW511, MW512, MW513, MW514, MW515, MW516, MW517, MW518, MW519, MW520, MW521, MW522, MW523, MW524, MW525, MW526, MW527, MW528, MW529, MW530, MW531, MW532, MW533, MW534, MW535, MW536, MW537, MW538, MW539, MW540, MW541, MW542, MW543, MW544, MW545, MW546, MW547, MW548, MW549, MW550, MW551, MW552, MW553, MW554, MW555, MW556, MW557, MW558, MW559, MW560, MW561, MW562, MW563, MW564, MW565, MW566, MW567, MW568, MW569, MW570, MW571, MW572, MW573, MW574, MW575, MW576, MW577, MW578, MW579, MW580, MW581, MW582, MW583, MW584, MW585, MW586, MW587, MW588, MW589, MW590, MW591, MW592, MW593, MW594, MW595, MW596, MW597, MW598, MW599, MW600, MW601, MW602, MW603, MW604, MW605, MW606, MW607, MW608, MW609, MW610, MW611, MW612, MW613, MW614, MW615, MW616, MW617, MW618, MW619, MW620, MW621, MW622, MW623, MW624, MW625, MW626, MW627, MW628, MW629, MW630, MW631, MW632, MW633, MW634, MW635, MW636, MW637, MW638, MW639, MW640, MW641, MW642, MW643, MW644, MW645, MW646, MW647, MW648, MW649, MW650, MW651, MW652, MW653, MW654, MW655, MW656, MW657, MW658, MW659, MW660, MW661, MW662, MW663, MW664, MW665, MW666, MW667, MW668, MW669, MW670, MW671, MW672, MW673, MW674, MW675, MW676, MW677, MW678, MW679, MW680, MW681, MW682, MW683, MW684, MW685, MW686, MW687, MW688, MW689, MW690, MW691, MW692, MW693, MW694, MW695, MW696, MW697, MW698, MW699, MW700, MW701, MW702, MW703, MW704, MW705, MW706, MW707, MW708, MW709, MW710, MW711, MW712, MW713, MW714, MW715, MW716, MW717, MW718, MW719, MW720, MW721, MW722, MW723, MW724, MW725, MW726, MW727, MW728, MW729, MW730, MW731, MW732, MW733, MW734, MW735, MW736, MW737, MW738, MW739, MW740, MW741, MW742, MW743, MW744, MW745, MW746, MW747, MW748, MW749, MW750, MW751, MW752, MW753, MW754, MW755, MW756, MW757, MW758, MW759, MW760, MW761, MW762, MW763, MW764, MW765, MW766, MW767, MW768, MW769, MW770, MW771, MW772, MW773, MW774, MW775, MW776, MW777, MW778, MW779, MW780, MW781, MW782, MW783, MW784, MW785, MW786, MW787, MW788, MW789, MW790, MW791, MW792, MW793, MW794, MW795, MW796, MW797, MW798, MW799, MW800, MW801, MW802, MW803, MW804, MW805, MW806, MW807, MW808, MW809, MW810, MW811, MW812, MW813, MW814, MW815, MW816, MW817, MW818, MW819, MW820, MW821, MW822, MW823, MW824, MW825, MW826, MW827, MW828, MW829, MW830, MW831, MW832, MW833, MW834, MW835, MW836, MW837, MW838, MW839, MW840, MW841, MW842, MW843, MW844, MW845, MW846, MW847, MW848, MW849, MW850, MW851, MW852, MW853, MW854, MW855, MW856, MW857, MW858, MW859, MW860, MW861, MW862, MW863, MW864, MW865, MW866, MW867, MW868, MW869, MW870, MW871, MW872, MW873, MW874, MW875, MW876, MW877, MW878, MW879, MW880, MW881, MW882, MW883, MW884, MW885, MW886, MW887, MW888, MW889, MW890, MW891, MW892, MW893, MW894, MW895, MW896, MW897, MW898, MW899, MW900, MW901, MW902, MW903, MW904, MW905, MW906, MW907, MW908, MW909, MW910, MW911, MW912, MW913, MW914, MW915, MW916, MW917, MW918, MW919, MW920, MW921, MW922, MW923, MW924, MW925, MW926, MW927, MW928, MW929, MW930, MW931, MW932, MW933, MW934, MW935, MW936, MW937, MW938, MW939, MW940, MW941, MW942, MW943, MW944, MW945, MW946, MW947, MW948, MW949, MW950, MW951, MW952, MW953, MW954, MW955, MW956, MW957, MW958, MW959, MW960, MW961, MW962, MW963, MW964, MW965, MW966, MW967, MW968, MW969, MW970, MW971, MW972, MW973, MW974, MW975, MW976, MW977, MW978, MW979, MW980, MW981, MW982, MW983, MW984, MW985, MW986, MW987, MW988, MW989, MW990, MW991, MW992, MW993, MW994, MW995, MW996, MW997, MW998, MW999, MW1000.

## 12.2.18 How to identify duplicate chemicals in a chemical spreadsheet.

**How to identify duplicate chemicals in a spreadsheet.**

1. Chemistry/Select Duplicates...
2. Enter table/spreadsheet name
3. Duplicate compounds will be selected and highlighted in blue

The screenshot shows the 'Find Duplicates' dialog box with the following fields and options:

- Find duplicated entries in set: [?] (dropdown)
- Table: [binding\_data] (dropdown)
- Use Chem3D:  (checkbox)
- Use SM:  (checkbox)
- Buttons: Ok, Cancel

The data table below shows columns for 'Product', 'MW', 'MWlogP', 'MWlogP', 'MWlogP', 'MWlogP', 'MWlogP', 'MWlogP', 'MWlogP', 'MWlogP', 'MWlogP', 'MWlogP', 'MWlogP', 'MWlogP', 'MWlogP', 'MWlogP', 'MWlogP', 'MWlogP', 'MWlogP', 'MWlogP', 'MWlogP'. The highlighted rows correspond to duplicate chemical structures.

## 12.2.19 How to compare two chemical spreadsheets.

**How to compare two chemical spreadsheets.**

1. Chemistry/Compare Two Sets...
2. Choose the tables you want to compare
3. Select the comparison method and output

The screenshot shows the 'Compare Two Sets' dialog box with the following fields and options:

- First Table: [binding\_data] (dropdown)
- Second Table: [binding\_data\_assay2] (dropdown)
- Distance: [1] (input field)
- Match:  (checkbox)
- Unmatch:  (checkbox)
- Select Matching Records:  (checkbox)
- Show Only Different Records:  (checkbox)
- Buttons: Ok, Cancel, Help

The data table below shows columns for 'Product', 'MW', 'MWlogP', 'MWlogP', 'MWlogP', 'MWlogP', 'MWlogP', 'MWlogP', 'MWlogP', 'MWlogP', 'MWlogP', 'MWlogP', 'MWlogP', 'MWlogP', 'MWlogP', 'MWlogP', 'MWlogP', 'MWlogP', 'MWlogP', 'MWlogP'. The highlighted rows correspond to matching chemical structures between the two datasets.

## 12.2.20 How to merge two chemical spreadsheets.

How to merge two chemical spreadsheets.

1. Chemistry/Merge Two Sets...

2. Choose the tables you want to compare

3. Select the way you want to merge them

## 12.2.21 Display and Convert Molecule

To display and convert a molecule from a molecular table in the 3D graphics display window:

- Select the molecule image or images in the molecular table.
- Right click and select the Chemistry/ Convert to 3D option.

2

Edit DB Record...

Query Molecule

Chemistry

Copy Row(s) Ctrl+C

Paste Ctrl+V

Print Table... Ctrl+P

Enumerate Stereoisomers (selected rows)

Enumerate Tautomers (selected rows)

Remove Salt (selected rows)

Convert to 3D and Optimize

Load and Preserve Coordinates

Conformation Generator (selected rows)

Chemical Template Superposition (selected rows)

209.024	2.38476	keyorganics:10R-0299
---------	---------	----------------------

## 12.2.22 Copy Molecule

To copy a molecule to paste into another application or into the ICM Molecular Editor:

- Right click on the molecule and a menu will be displayed.
- Select the option "Copy Molecule"

To copy a molecule or image to paste into another row within an ICM table or into the ICM Molecular editor:

- Right click on the molecule and a menu will be displayed.
- Select the option "Copy Molecule"
- Right click in the cell into which you wish to paste the molecule.
- Select the option "Paste Molecule"

**NOTE:** To learn how to insert a row read the `insert row` section.

Molecules drawn in ICM can be cut and pasted into ISIS–Draw and molecules from ISIS–Draw can be cut and pasted into ICM.

To perform these functions the correct settings need to be turned on in ISIS–Draw so that the compound drawing is saved in the clipboard.

*IN ISIS–DRAW* – Go to Options/Settings/General/Copy Mol Rxn file to the clipboard.

Compounds drawn in ISIS Draw can be cut and pasted into the ICM Molecular Editor and into ICM tables. Compounds can be copied in ICM by:

- Right click on the compound in the chemical table and select Copy Molecule.

### 12.2.23 Edit Molecule

*To edit a molecule:*

- Right click on the molecule and a menu will be displayed.
- Select the option **Edit Molecule** and the ICM Molecular Editor will be displayed.
- Edit the molecule.
- Click Exit in the ICM molecular editor.

### 12.2.24 Color Table Column

*You can color your table based on values within a column by:* You can also color the compound according to specific values see `Color Chemical Structure`.

- Selecting the column.
- Right click on the column header and a menu will be displayed.
- Select the option "Color By"

**NOTE:** You can remove the color from the table by right clicking on the column header selecting **Clear Selection Color**.

*Rows can be colored by marking them as described [here](#)*

### 12.2.25 Chemical Display

There are various display options for chemicals contained in ICM molecular tables. Most of these options are accessed by right clicking on the table column header "mol".



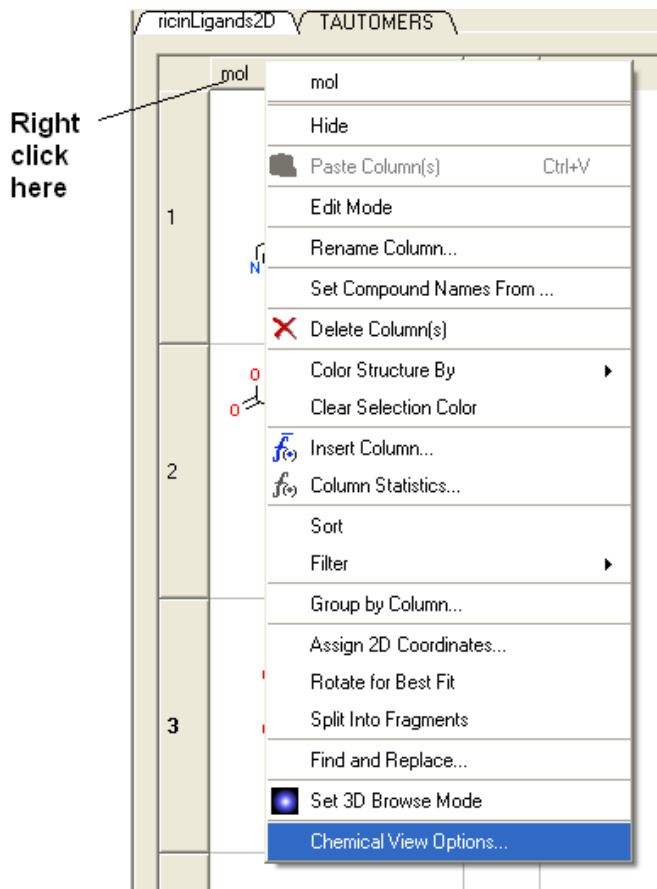

## 12.2.26 Chemical View Options

Different chemical view options in the ICM molecular table can be set.

- Right click on the "mol" column header.
- Select Chemical view options... and the following data entry box will be displayed

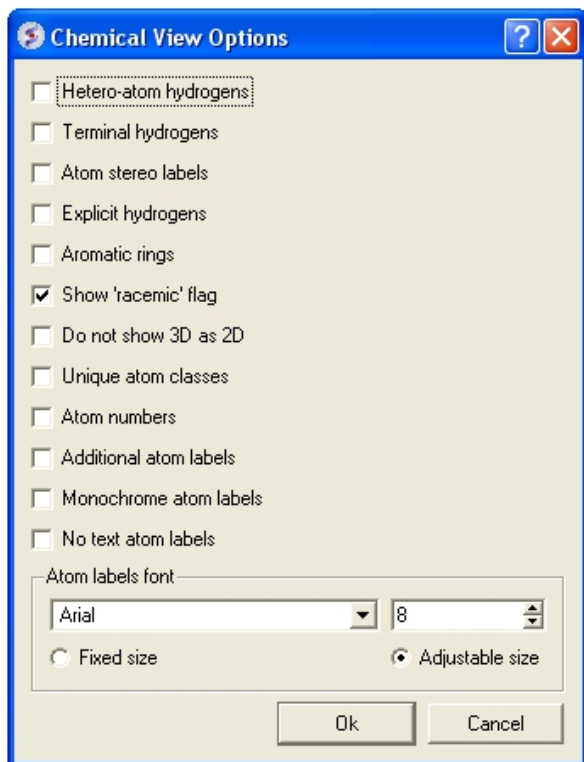

Options can be changed by checking the appropriate boxes or by entering the desired font and size.

## 12.2.27 Chemical Table Side-by-Side View

Chemical tables can be visually compared by placing them side-by-side. This can be done by:

- Double click on the table header for side-by-side view.
- Double click on the table header again to remove side-by-side view.

Double click here for "side-by-side" view

ricinLigands2D		ricin_inhibitors		
	mol	MolWeight	MolLogP	MolLogS
1		142.118	-0.589686	-1.70292
2		150.141	-0.070759	-2.11729

## 12.2.28 Zoom, Translate and Z-rotate a Chemical in a table.

Sometimes you may want to get a better view of a chemical in an ICM molecular table you can do this inside the chemical table by:

- Double clicking on the chemical drawing and the background will turn yellow.

Left click and drag here to zoom

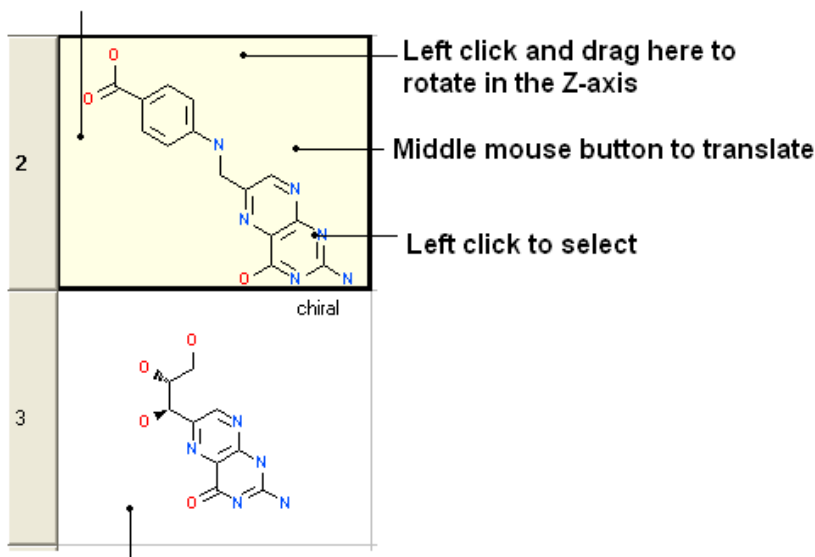

Double click for yellow background to enable changes in chemical display

**NOTE:** You can also browse your structures in 3D. See section entitled "Set Chemical Table 3D Browse Mode".

## 12.2.29 Set Chemical Table 3D Browse Mode

To browse the chemicals contained within an ICM molecular table in the graphical display:

- Right click on the "mol" column header.
- Select Set 3D Browse Mode

ricinLigands2D TAUTOMERS

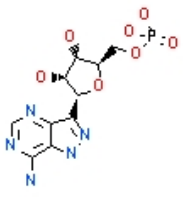
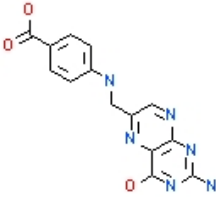
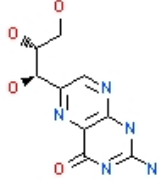
	mol	L	NAME_
1	 <p>chiral</p>	<input checked="" type="checkbox"/>	
2		<input type="checkbox"/>	
3	 <p>chiral</p>	<input checked="" type="checkbox"/>	

Double click here to view in the graphical display

3D Graphics

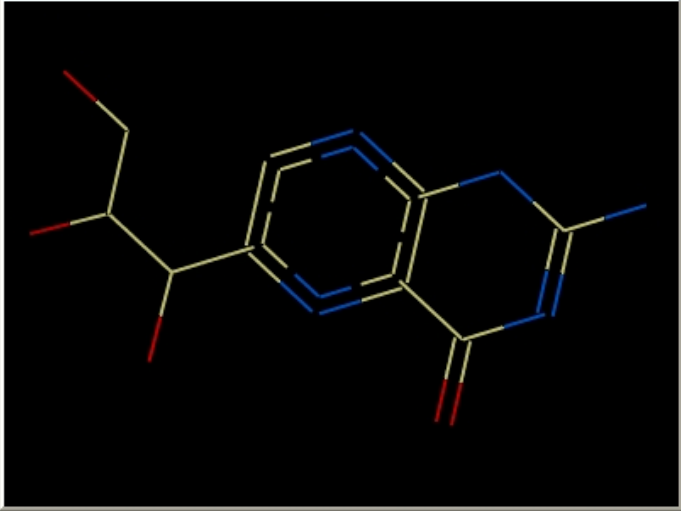

To keep a compound in the graphical display and ICM Workspace check here

To remove 3D browse:

- Right click on the "mol" column header.
- Select UnSet 3D Browse Mode

### 12.2.30 Chemical Find and Replace

Chemical Findtool allows you to find an arbitrary chemical fragment with one or more attachment point(s) and replace it with another fragment with the same number of attachment points.

*To find a substructure and replace it with something else:*

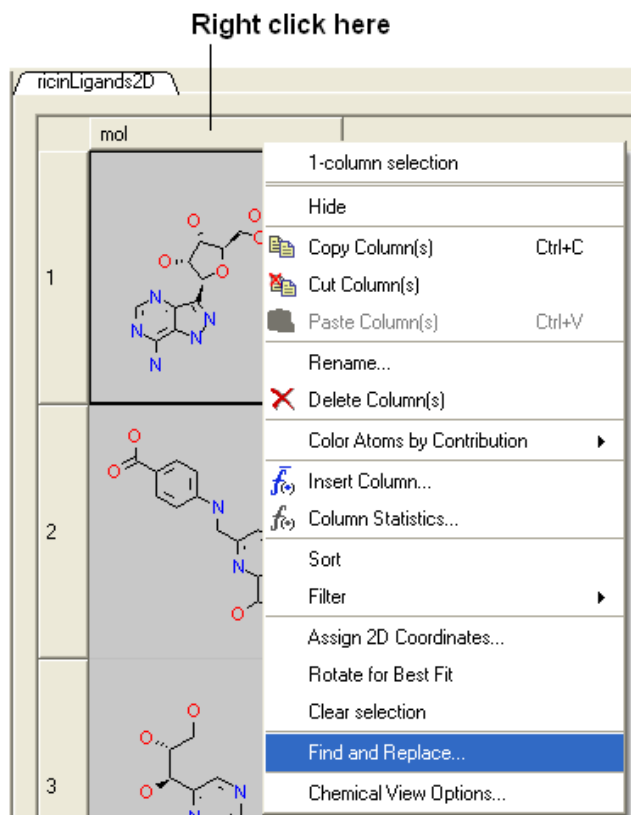

- Select the column in which the molecular structures are displayed. The column is usually called "mol".
- Right click on the "mol" column header and select Find and Replace. A data entry box as shown below will be displayed.

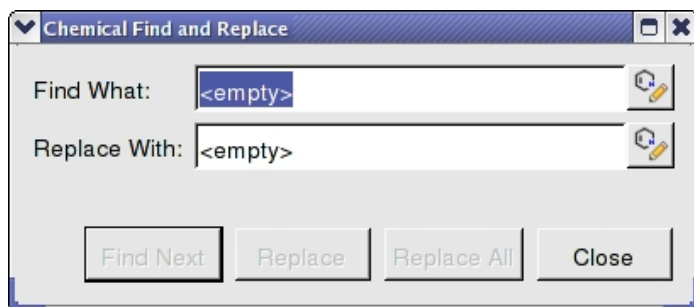

- Click on the Molecular Editor button at the end of the Find What: data entry box.
- The ICM Molecular Editor will be displayed. Draw the substructure you wish to search for and replaced.
- Draw the pattern and mark attachment points with R1,R2.... R-groups can be added by right clicking at the attachment point and selecting the R-group from the drop down options.
- Close the ICM Molecular Editor and the string will be displayed.
- Repeat with the "Replace With:" data entry box. Make sure the same number of R1,R2... labels are drawn.
- Click the Find Next button and then Replace or Replace All. When a substructure to replace is identified it will be colored red.

**NOTE:** There are a number of keyboard shortcuts which can be used to draw chemicals. Also please note that an aromatic bond in the source molecule will not match a double bond in the replacement pattern.

Here is an example:

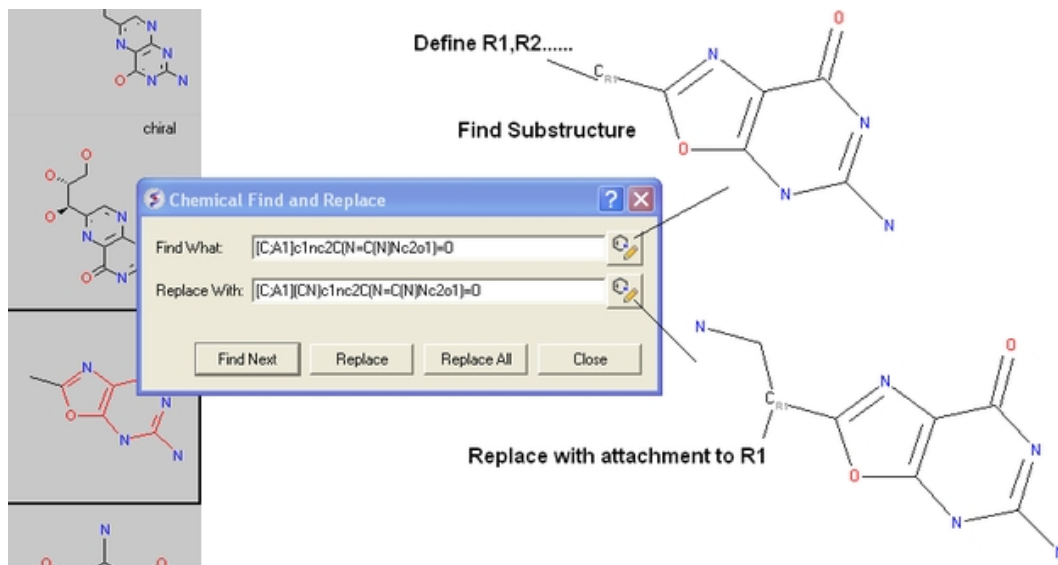

### 12.2.31 Split Chemical(s) into Fragments

Chemicals displayed in an ICM Molecular Table can be split into fragments. This is useful for generating a series of R-groups to be added to a scaffold (See section describing reactions).

To generate fragments:

- Select the column or row(s) you wish to generate the fragment from.
- Right click on the "mol" column header and select "Split Into Fragments".
- A new table of chemical fragments will be displayed. Each fragment is assigned an attachment point which is flagged with an asterisk (\*).

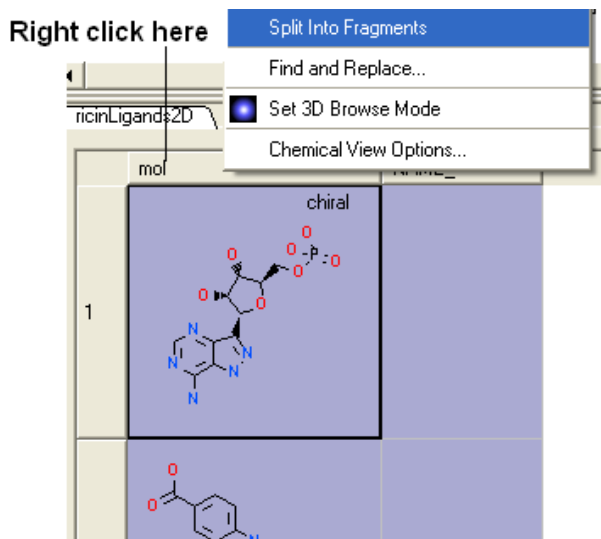

New table is generated containing fragments

mol	cnt	n_apo
	1	1
chiral	1	2

### 12.2.32 Rotate Chemical for Best-Fit

To improve the display of a chemical within an ICM molecular table you can choose an option called "Rotate for best fit".

This option can be found by:

- Right click on the "mol" column header.
- Select "Rotate for Best Fit"

### 12.2.33 Color Chemical Structure

To color the structure of a chemical in an ICM molecular table by fragment of pharmacophore frequency:

- Right click on the "mol" column header.
- Select Color Structure By
- Select "By Fragment Frequency" or "By Pharmacophore Features"

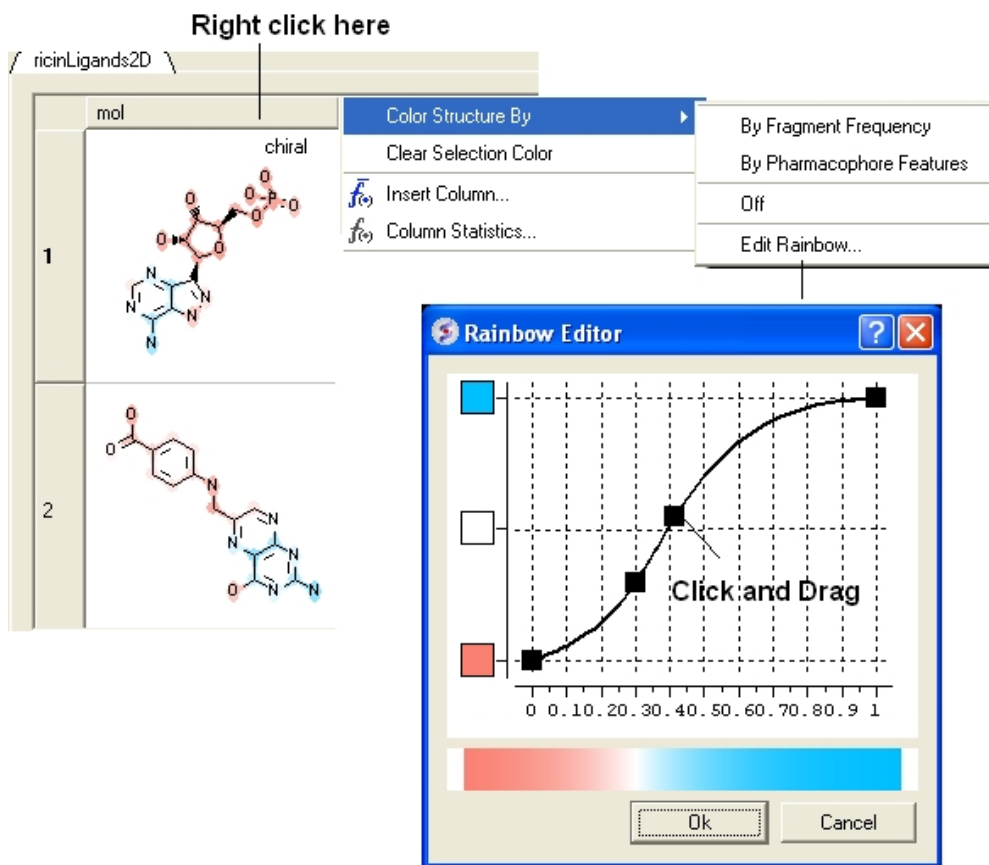

**NOTE:** The coloring can be controlled using the "Edit Rainbow" option and the coloring can be removed using the "Off" option

## 12.3 Molecular Editor

Draw new compounds by using the ICM Molecular Editor.

*The molecular editor can be activated by:*

- Clicking on the Open ICM Molecular Editor button shown below.

### Open ICM Molecular Editor

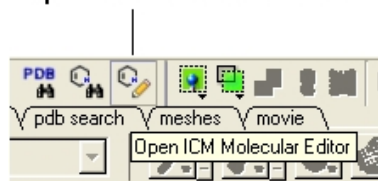

OR

- Select Chemistry/Molecular Editor and the editor as shown below will be displayed.



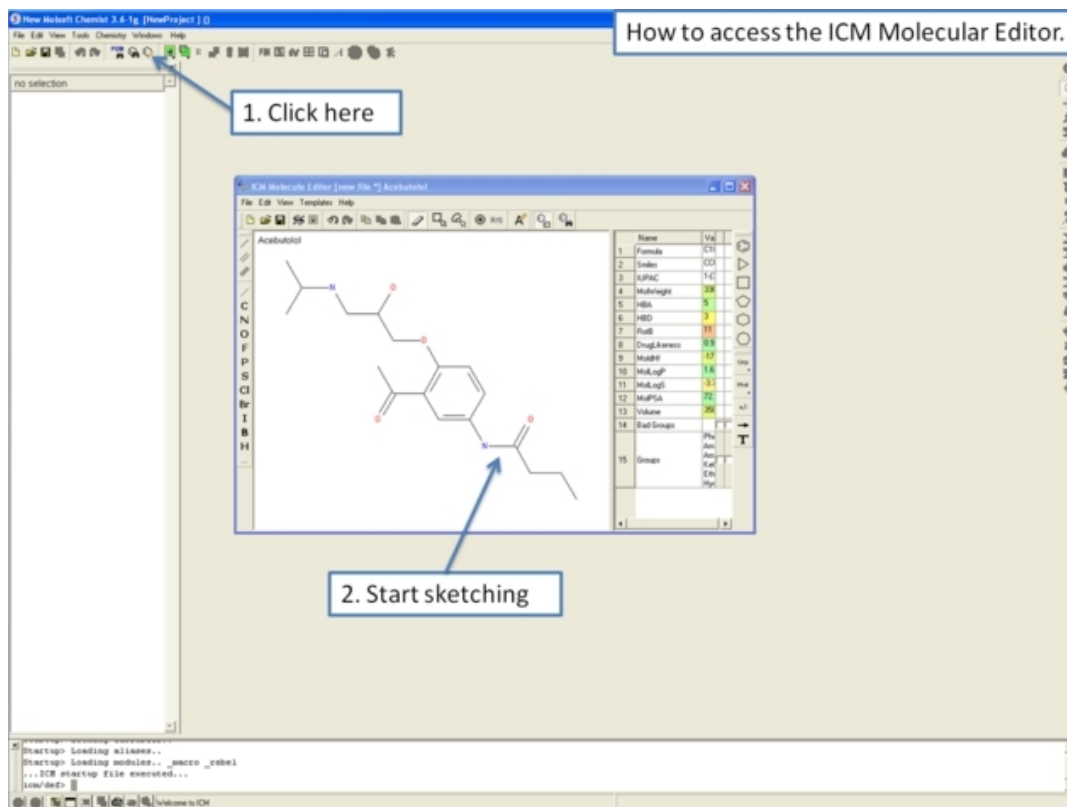

### 12.3.1 Drawing a New Chemical Structure

To draw a new chemical structure the ICM Molecular Editor should be loaded.

To do this:

- Select Chemistry/Molecular Editor

Now you can start drawing your structure.

- First select one of the appropriate buttons on the left hand side of the molecular editor.
- Then click in the white Molecular Editor Workspace and your element, ring or bond will be displayed.

How to sketch chemicals in the ICM Molecular Editor.

1c. Click Templates menu for even more templates

1a. Select atoms and bonds here

1b. Select rings here

2. Click on the canvas to start sketching

Name	Val
1 Formula	CH
2 Smiles	CC
3 IUPAC	1C
4 Molecular Weight	29
5 MW	5
6 HBD	3
7 RotB	15
8 Drug likeness	28
9 Hindex	13
10 MolLogP	1.6
11 MolLogP	3.3
12 MolPSA	72
13 Volume	26
14 Bad Groups	
15 Groups	

- You can extend your structure by selecting another button from the left hand-side as before.
- Select where on the structure you would like to add the new group by hovering the mouse over the desired position. The position you will add to will be highlighted in a red box.

File Edit View

New structural elements will be added from the position highlighted by a red box.

Simply hover the mouse over the position you wish to add to.

#### To change the direction of a bond:

- Right click on the bond and a menu as shown below will be displayed.
- Select which bond direction you desire from up, down or either.

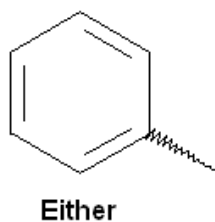
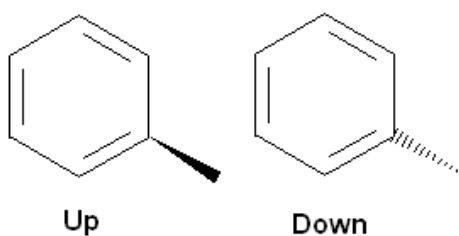
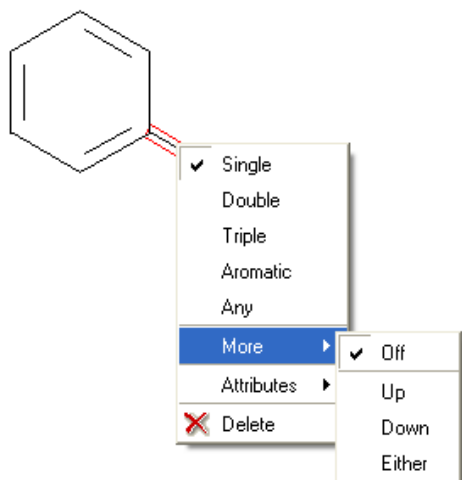

Carry on drawing until your structure is complete! See the other sections in this chapter.

1. To save your structure read the `save` and `append chemical structure` section.
2. To append your structure to an existing SDF file read the `save and append chemical structure` section.
3. To save your structure to an ICM table read the `save and append chemical structure` section.
4. To edit your structure read the `edit your structure` section.

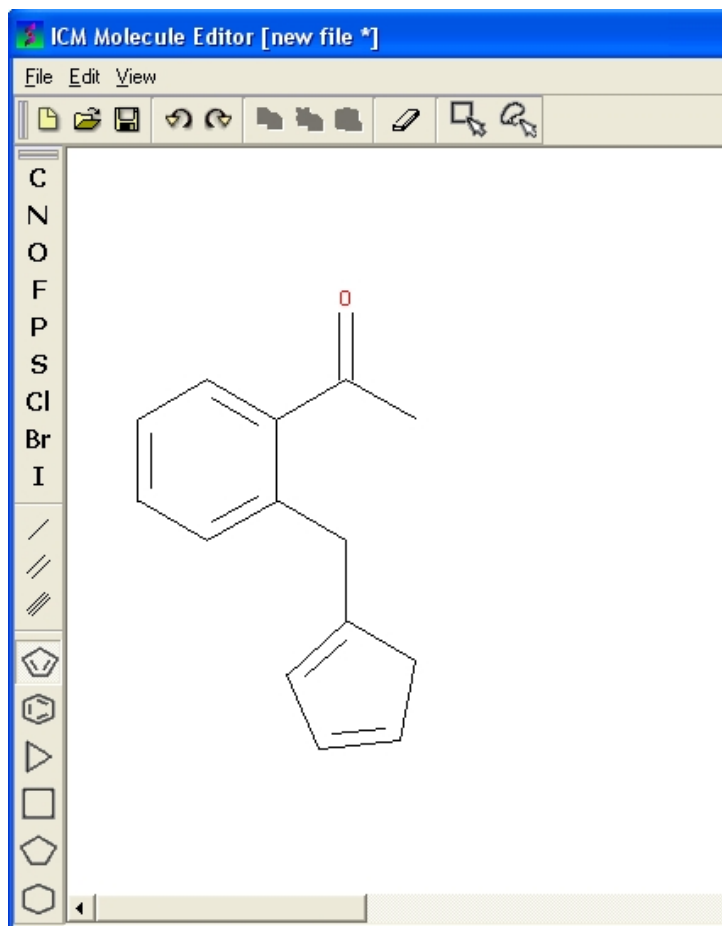

### 12.3.2 Right Click Options

There are a number of different options available when you **right click** on a **bond** or **atom**. These options are described in detail in the Chemical Searching part of the manual.

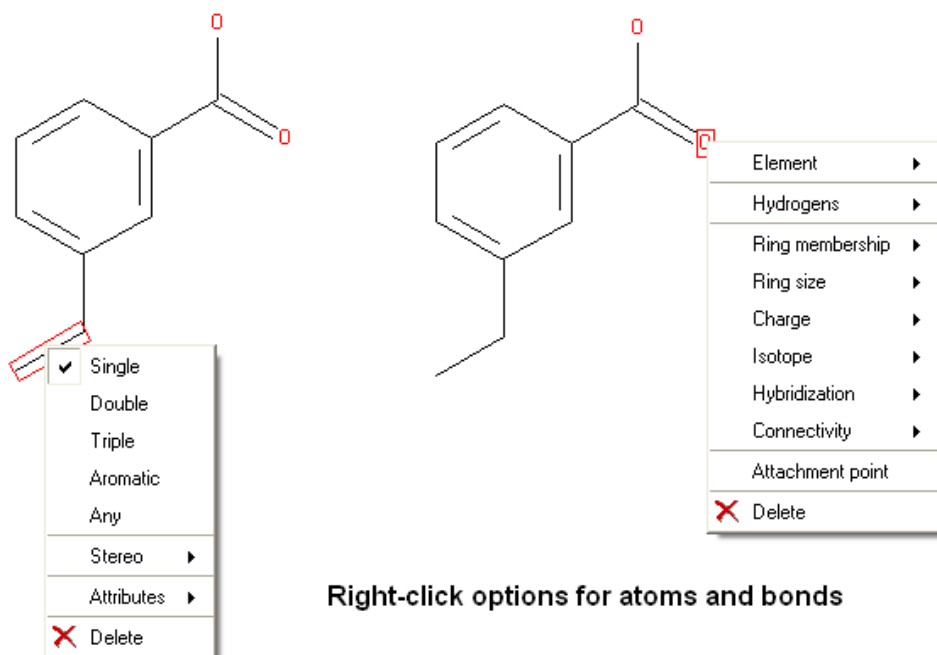

Right-click options for atoms and bonds

### 12.3.3 A dictionary of chemical groups.

The ICM Chemical Editor has a dictionary of chemical groups. These groups are stored in a table stored in CHEM\_GROUPS . csv file. This file can be manually edited to remove or add new definitions. The group can be selected using the Grp button of the Editor.

### 12.3.4 Adding and rotating a fragment in molecular editor by clicking–holding–and–dragging.

The Chemical Editor allows one to add bonds (click the bond button), or chemical groups (the Grp button). Often one needs to re-orient the added bond or fragment. In this case press on the atom to which you are going to append the bond or the fragment and **hold-and-drag** the mouse it until you see added fragment rotating around the attachment point. While you keep the mouse button pressed you can **rotate** by dragging in the preferred direction.

If you add templates (the Templates menu, or **paste** fragments, the mechanism is somewhat different because the group is added in its default orientation. In this case you can press **Ctrl** to rotate the fragment to be able to attach the fragment in the desired orientation.

### 12.3.5 Property Monitor

When drawing a compound in ICM you can monitor important ADME-Tox and drug-likeness properties.

*To view the drug-likeness monitor*

- ICM Molecular Editor/View/Chemical Monitor and a window as shown below will be displayed.

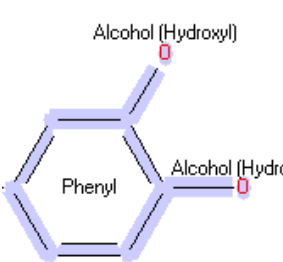

The image shows a chemical structure of 1,2-diphenylethanol, consisting of two phenyl rings connected by an ethane chain, with hydroxyl groups attached to the two carbon atoms of the ethane chain. Labels 'Alcohol (Hydroxyl)' and 'Phenyl' are present on the structure.

	Name	Value	
1	Formula	C9 H13 O	
2	Smiles	CNCC(C	
3	MolWeight	183.089	
4	HBA	4	
5	HBD	4	
6	RotB	3	
7	DrugLikeness	1.91	
8	MoldHf	-110.33	
9	MolLogP	-0.11	
10	MolLogS	-1.54	
11	MolPSA	61.46	
12	Volume	173.62	
13	Bad Groups		<input checked="" type="checkbox"/>
14	Groups	Phenyl Amine Alcohol	<input checked="" type="checkbox"/>

Click here to label and highlight groups

The following properties are monitored.

- Molecular Weight (MolWeight)
- Number of Hydrogen Bond Acceptors (HBA)
- Number of Hydrogen Bond Donators (HBD)
- Number of Rotatable Bonds (RotB)
- DrugLikeness value Druglikeness is not based on other properties, this is separate model built using Bayesian Classifier. <http://www.molsoft.com/mpropdesc.html> – Normally Bayesian classifier returns either 1 or -1 (positive or negative) So, roughly speaking: positive values means drug-like, negative – not.
- Prediction model build for 'delta Hf in gas' property. using public NIST database. Description can be found: <http://webbook.nist.gov> A low dHf value means that the compound is more 'stable'.
- LogP
- LogS

- Polar Surface Area (PSA)
- Volume
- Formula
- Smiles String
- Bad ADME-Tox Groups

The rows in the monitor window are colored from green (good) to red (poor) ADME-Tox properties.

### 12.3.6 Editing structure using keyboard

You can select a fragment or simply position your mouse cursor over a bond or atom and use the following keystrokes for editing:

- **Changing atom properties**
- d set/unset heavy *atom connectivity* as drawn to avoid additional branches in chemical searches. Toggle.
- r set/unset the "**in-ring**" property of *atoms*. Toggle.
- y set/unset *atom hybridization type* ( *sp1,sp2,sp3* ). Toggle.
- A set *atomic* property to be **aliphatic**
- a set *atomic* property to be **aromatic**
- \* (asterisk) set *atomic* property to be **any atom**
- C Carbon
- H Hydrogen
- N Nitrogen
- O Oxygen
- F Fluorine
- P Phosphorus
- S Sulfur
- I Iodine
- **Changing chemical bonds**
- 1,- (dash) **single bond**.
- 2,= (equal) **double bond**.
- 3,# (hash) **triple bond**.
- 4,: (column) **aromatic bond**.
- 0,~ (tilde) **any bond**
- **Changing R-Groups**
- Press 1 to mark an atom as R1
- Press Ctrl-1 to preserve its type and create [C;R1]
- Press Ctrl-0 to remove the mark.

### 12.3.7 Save and Append Chemical Structures

Once you have drawn a chemical structure (see Drawing a New Chemical Structure) then you can save the structure in the following ways:

1. By saving the structure as a MOL file or SDF file on your machine or server.
2. Appending the structure to an already created SDF file.
3. Appending the structure to an ICM Molecular table.

*To save the structure as a MOL or SDF file on your machine or server.*

- In the Molecular Editor window select File/Save
- Enter a filename and select where you wish to save the file.

**NOTE:** Other save options can be found on the ICM Molecular Editor Toolbar.

How to save a 2D sketch in mol format.

1. Click here

Note: More save options can be accessed by going to File/Save as...

Name	Val
1 Formula	CS
2 Index	CG
3 IUPAC	1G
4 Multiangle	20
5 HBA	5
6 HBD	3
7 RotD	31
8 DrugAccess	50
9 HmolE	13
10 MolLogP	1.6
11 MolLogD	-3.1
12 MolPka	72
13 Volume	26
14 Bond Groups	
15 Groups	

**To append the structure to an already created sdf file.**

- In the Molecular Editor window select File/Append to SD file...
- Search for the SDF file you wish to append to and select OK. This SDF file can be read into ICM as described in Read Chemical Structure section of this manual.

**To append your structure to an ICM table:**

- In the Molecular Editor window select File/Append to table
- A list of loaded ICM tables will be displayed as shown below. If you dont have any ICM table loaded or you wish to add the structure to a new table select the "new" option.
- The structure will be automatically added to an ICM table and displayed in the GUI.

OR

- Click click on the append to table button in the editor (see below).

How to save a 2D sketch into a chemical spreadsheet.

1. Click here and enter when prompted the name of spreadsheet and chemical name.

2. New chemical spreadsheet

Name	Val
Formula	C <sub>21</sub> H <sub>28</sub> N <sub>2</sub> O <sub>4</sub>
Smiles	CC(=O)N(CCC)CCOC(=O)c1ccc(NC(=O)CC)cc1
MW	384
MolWeight	384
Index	1
MDL	1
PubID	11
DrugRank	8.3
MolVol	117
MolLogP	1.6
MolLogS	1.1
MolPICA	22
Volume	26
Bad Groups	
Groups	Ph, Am, Carb, Est, Hbr

**NOTE:** For more information on how to manipulate standard ICM Tables and Molecular Tables see the Table section of this manual.

### 12.3.8 Editing a Chemical Structure

If you make a mistake whilst drawing a chemical structure or if you wish to change an already saved and loaded structure there are a number of editing tools and techniques which can be used.

*To edit a structure which is in a loaded ICM molecular table:*

- Right click on the structure in the table and a menu as shown below will be displayed.

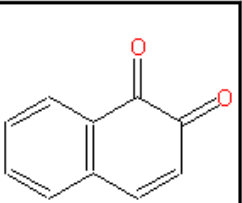

- Select the Edit Mode and a black square will be displayed around the chemical you wish to edit.
- Double click on the structure and the ICM Molecular Editor will be activated.

mol	MOLNAME
	1,2-NAPHTHOQUINONE

Double click here to edit

*To edit a bond or atom in the structure:*

- First select the new bond, atom or ring from the buttons on the left of the ICM Molecular Editor.

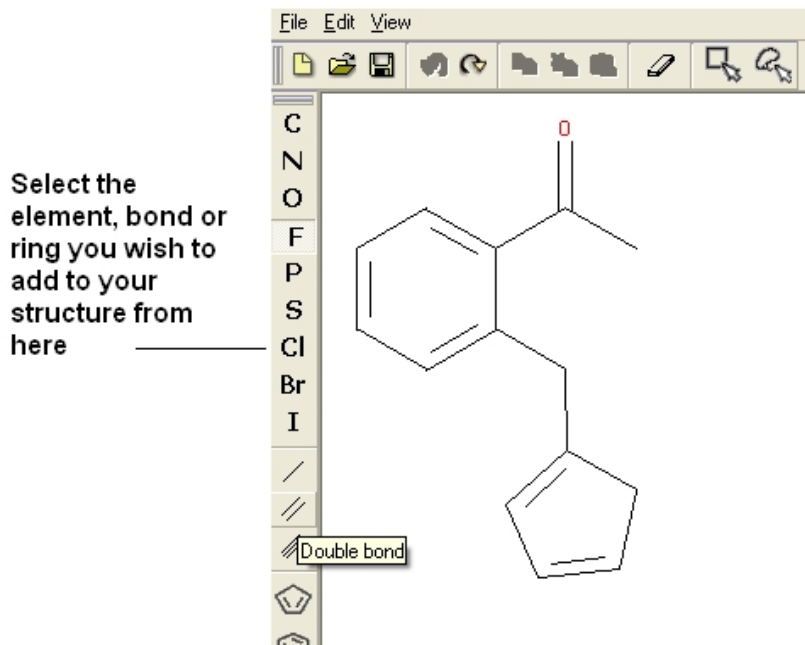

- Hover over the element or bond you wish to change in the ICM Molecular Editor workspace. A red square will be displayed over the bond or element you select as shown below.

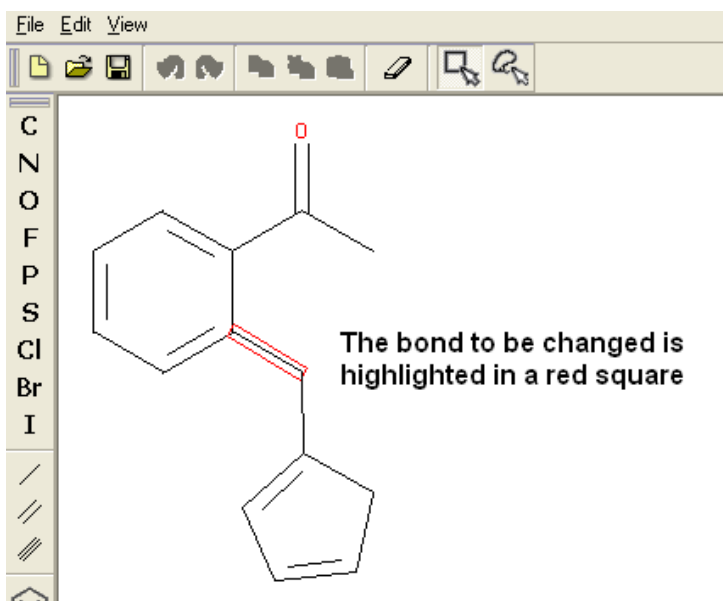

- Click on the bond or element and it will automatically change to your selection.

***To delete parts of a structure:***

- Select the eraser button on the ICM Molecular Editor Toolbar.

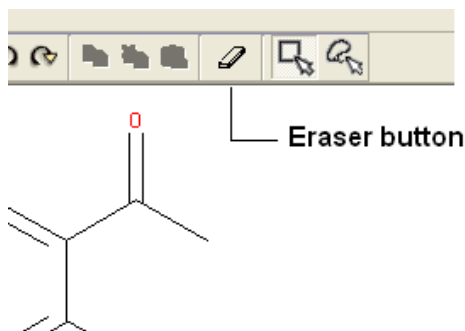

- Click on the regions you wish to delete.

Alternatively you can select the delete option in the ICM Molecular Editor "Edit" menu.

**NOTE:** A quick image can be constructed using the camera button A quick image can be constructed using the camera button as described in the TIPS section of this manual .

### 12.3.9 Molecular Editor Selections

Selections can be made in the ICM Molecular Editor using the two buttons shown below.

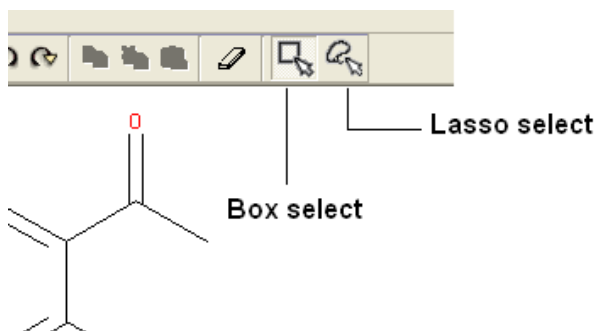

Selections are displayed in green.

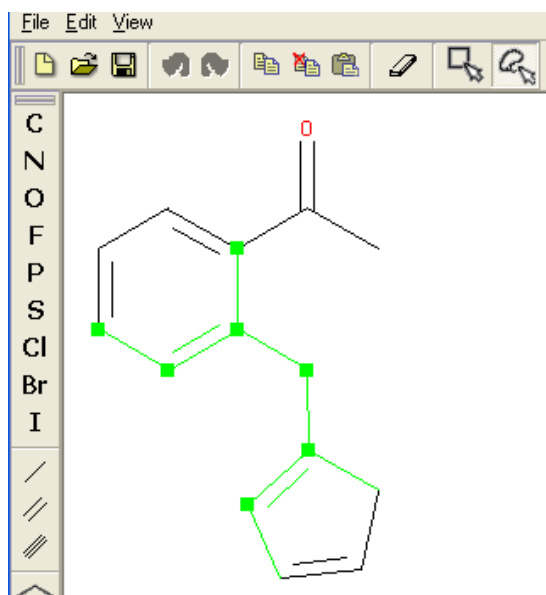

### 12.3.10 Copy, Cut and Paste

To copy, cut and paste part or all of your structure.

- First select the parts you wish to copy or cut by reading the instructions in the Molecular Editor Selections section of this manual.
- Select copy or cut from the ICM Molecular Editor "Edit" menu.
- The selected regions will then be placed on the copy clipboard and can be pasted into the ICM Molecular Editor or any other program.

The copy and paste buttons and menus are shown below:

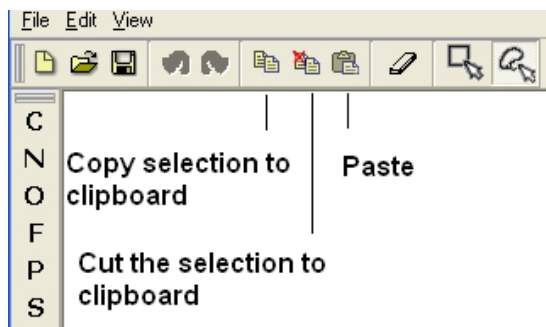

OR

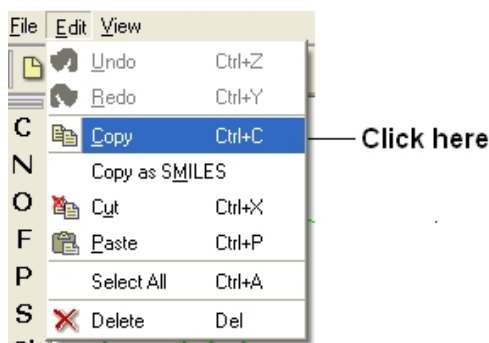

*To copy your structure as a smiles string:*

C1C=CC=C(C=1C(C)=O)CC(CC=C1)=C1

- Select the "Copy as SMILES" option in the ICM Molecular Editor "Edit" menu.

This will place the SMILES string on the clipboard which can then be pasted into any application.

### 12.3.11 How to use SMILES strings to sketch a chemical.

How to use SMILES strings to sketch a chemical.

Edit Add Smile

The screenshot shows the ICM Molecular Editor interface. A chemical structure of a substituted benzene ring is displayed in the center. To the right, a table lists various properties of the molecule:

Name	Value
Formula	C19 H28 N2 O4
Smiles	CCCCNC1=CC=CC=C1O
IUPAC	1-(3-oxopropyl)-4-(hydroxyphenyl)pyrrolidine
MolWeight	356.2049
Atoms	9
Bonds	3
Radius	15
DrugAccess	9.91
MolRef	17617
MolLogP	1.68
MolLogS	3.77
MolPka	72.22
Volume	360.44
Bad Groups	
Groups	Phenyl Amide Amine Ketone (Carbonyl) Ether Hydroxyl

Example of a SMILES string C1C=CC=CC=1

### 12.3.12 Undo and Redo

The undo and redo options for the ICM Molecular Editor are located in the Edit menu and on the toolbar as shown below.

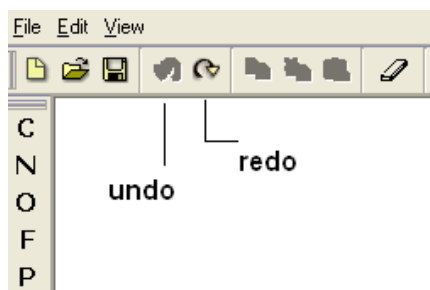

OR

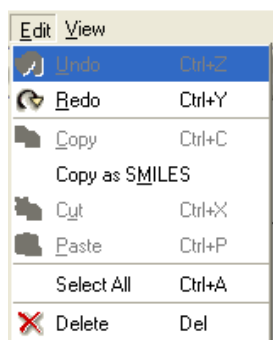

## 12.3.13 Isis Draw Copy and Paste

Molecules drawn in ICM can be cut and pasted into ISIS–Draw and vice–versa molecules from ISIS–Draw can be cut and pasted into ICM.

To perform these functions the correct settings need to be turned on in ISIS–Draw so that the compound drawing is saved in the clipboard.

*IN ISIS–DRAW* – Go to Options/Settings/General/Copy Mol Rxn file to the clipboard.

Compounds drawn in ISIS Draw can be cut and pasted into the ICM Molecular Editor and into ICM tables. Compounds can be copied in ICM by:

- Right click on the compound in the chemical table and select Copy Molecule.

## 12.4 How to extract a 2D sketch of a ligand in complex with a PDB structure.

How to extract a 2D sketch of a ligand in complex with a PDB structure.

1. Click here to search the PDB
2. Right click on the ligand in the ICM workspace
3. Click Edit/ Edit Compound and the ICM Molecular Editor will be displayed.

## 12.5 Saving Chemical Structures and Images

There are a variety of ways to save chemical structures. Chemicals can be saved in mol, sdf and smiles format from a chemical table (spreadsheet), molecular editor or from the ICM–Workspace. An image of the 2D sketch can be saved as an image from a chemical table.

### 12.5.1 Saving from a chemical table.

To save all the chemicals in a table as an SDF file:

- Right click on the chemical table header.
- Select **Save as..**
- Select **Save as type:** (SD file or Mol file\_

Right click here

	mol	MolWeight	MolPSA	MolLogS
1		7.226	157.205	-1.44554
2		312.29	114.926	-4.43001

To save selected chemicals in a table as an SDF file:

- Select the row(s) of the chemicals you wish to save in SDF format. Row selections in tables is described in the Tables chapter.
- Right click on any of the selected rows and select **Save Selection As...**

Select rows here

	mol	MolWei
1		347.226
2		312.29
3		253.219

Right click here

## 12.5.2 Saving Chemicals in the Molecular Editor

Chemicals drawn in the ICM Molecular Editor can be saved:

- **File/Save** or **File/Save As...** or **Edit/Copy as SMILES**

## 12.5.3 Saving Chemicals in the ICM Workspace

If you have converted a chemical sketch into 3D, the 3D structure will be displayed in the ICM Workspace. To save this structure in mol format:

- Right click on the name of the chemical in the ICM Workspace.
- Select **Save As..**

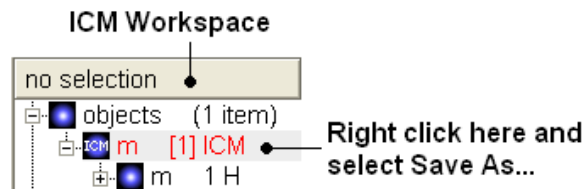

## 12.5.4 Saving Chemical Images

To save an image of a chemical sketch:

- The chemical needs to be displayed in a chemical table.
- Right click on the 2D image
- Select **Save Molecule As Image**

**NOTE** Using the right click options you can also save the image to the **clipboard** or copy the molecule to the ICM Image Album for use in Molecular Documents.

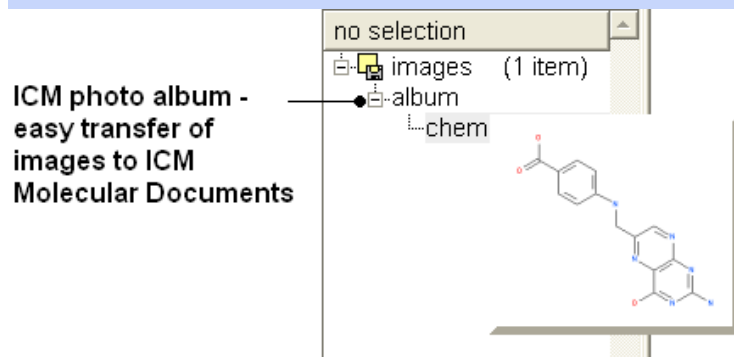

## 12.6 Export to Excel

To export a chemical spreadsheet to MS Excel:

- Right click on the chemical spreadsheet header in ICM.
- Select **Export to Excel**



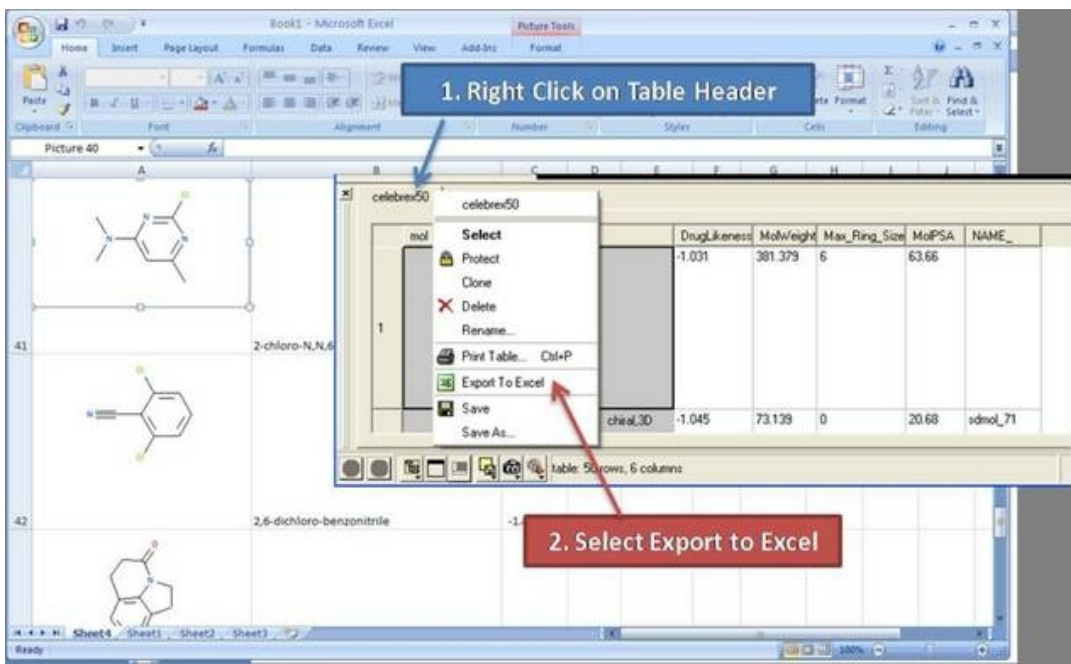

## 12.7 IUPAC Chemical Nomenclature

The IUPAC nomenclature for a compound can be generated on the fly for a chemical. You can view the IUPAC name in the Molecule Editor or you can insert a column into a chemical spreadsheet with the IUPAC name.

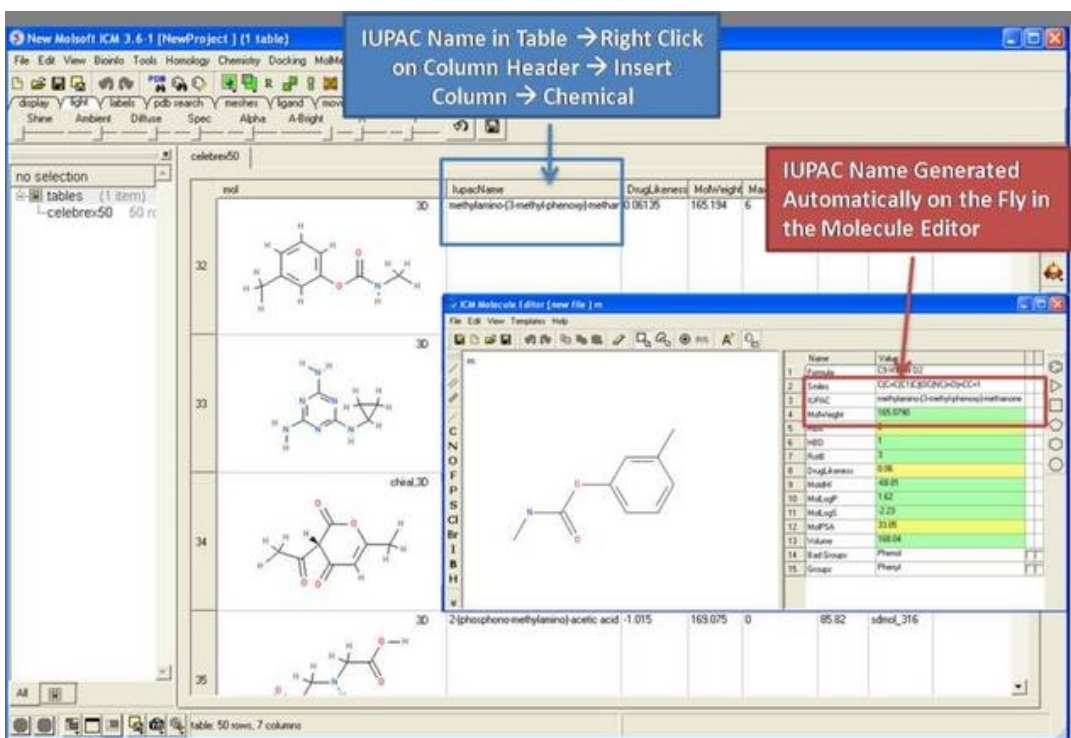

## 12.8 Chemical Search

Chemical similarity searching can be used to screen a database of compounds for structural similarity to a query chemical structure. The chemical similarity search window is shown below.

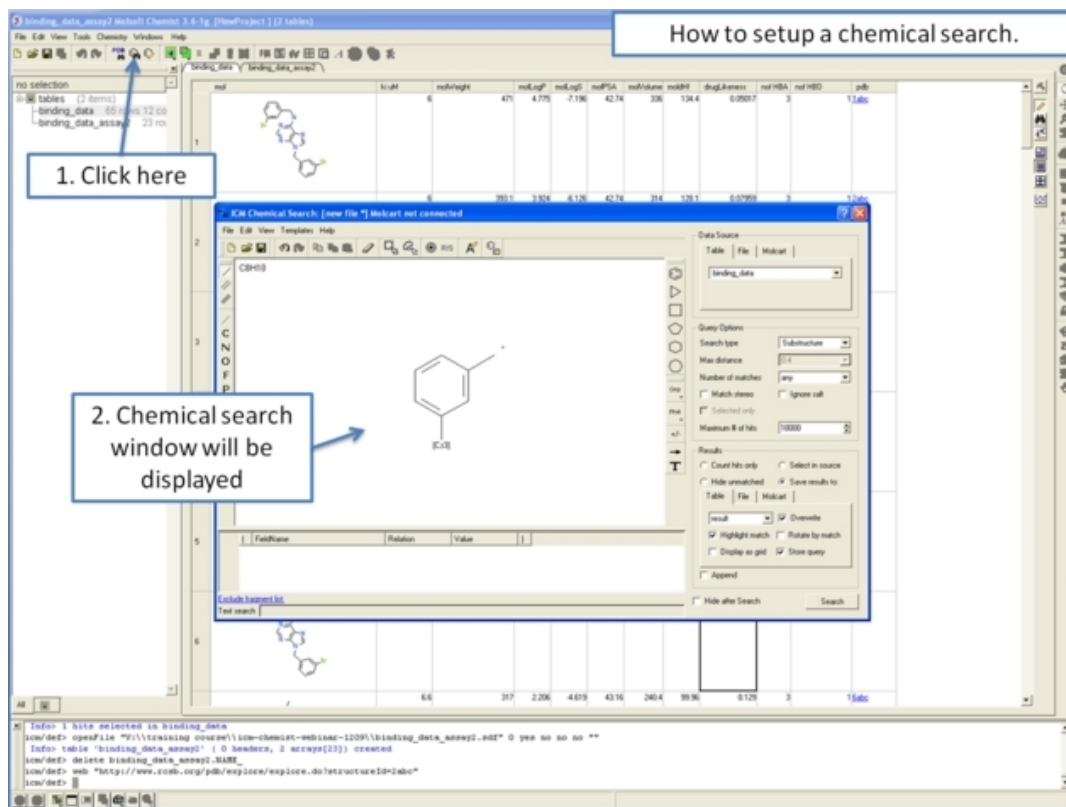

To access this window use the Tools/Chemical Search menu or select the button shown below.

### Chemical search

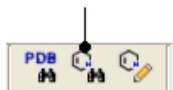

## 12.8.1 Query Setup

To set up a query first you must have either drawn or loaded a chemical structure into ICM. Instructions for this are described in the [Reading Chemical Structures](#) and [Molecular Editor](#) sections of this manual. If for example the query molecule you want to search is in a chemical spreadsheet you can right click on chemical in the spreadsheet and select **Query Molecule**.

At this point your query can be modified as described in the [Molecular Editor](#) sections of this manual. **However**, there are a number of ways to specifically modify your query and filter your search. The way to accomplish this is to right click on a bond or atom and a menu as displayed below will be displayed. The menus differ depending on whether you right click on a bond or atom.

If you wish to specify a filter at an atom.

- Right click on the atom and the menu shown below will be displayed.

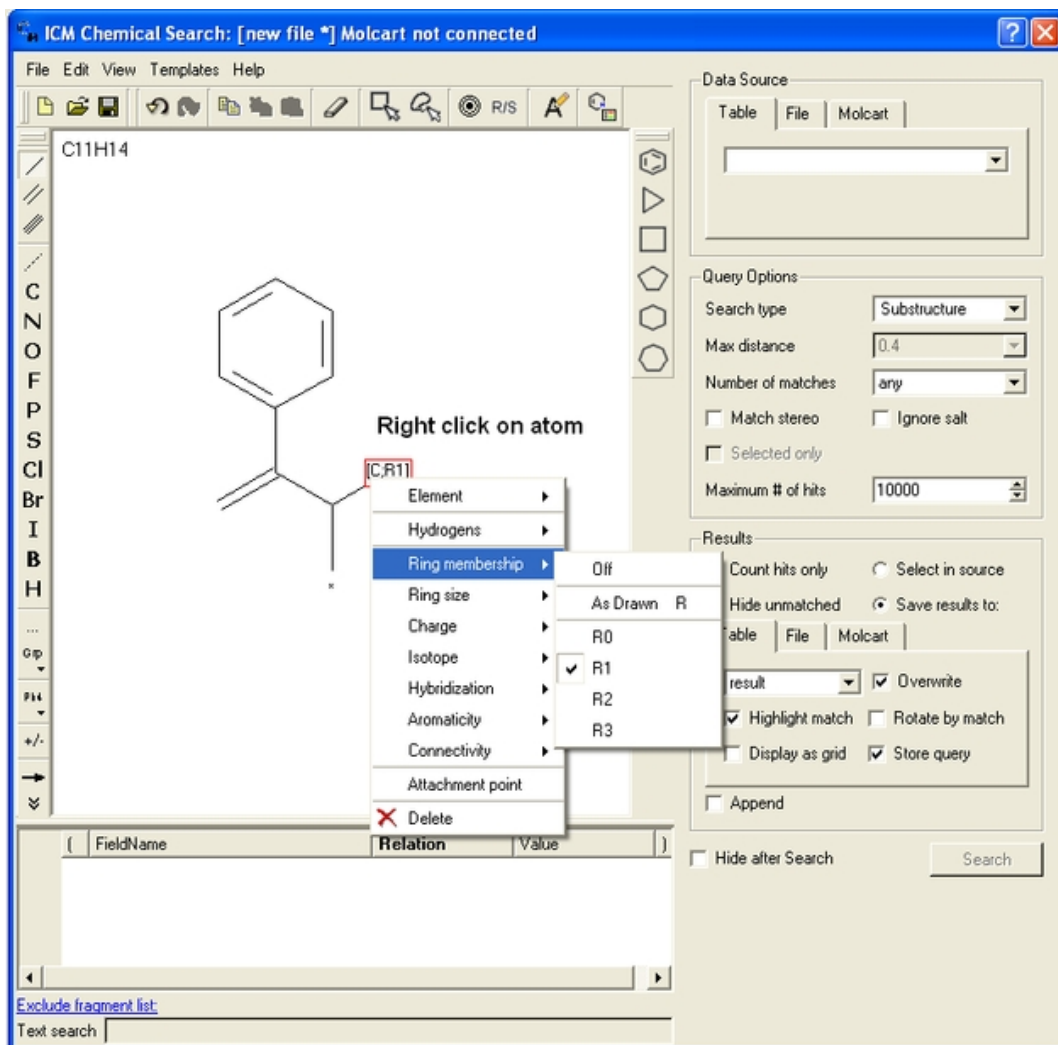

If you wish to specify a filter at a bond.

- Right click on the bond and the menu shown below will be displayed.

The screenshot shows the ICM Chemical Search interface. The main window displays a benzene ring with a bond highlighted in red. A context menu is open over this bond, listing options: Single, Double (checked), Triple, Aromatic, Any, Stereo, Attributes, and Delete. The text "Right click on bond" is written next to the menu. The software interface includes a menu bar (File, Edit, View, Templates, Help), a toolbar, a vertical element list (C, N, O, F, P, S, Cl, Br, I, B, H), a search results table with columns for FieldName, Relation, and Value, and a right-hand panel with "Data Source", "Query Options", and "Results" sections.

*To specify a particular atom type, aromatic, aliphatic or R-group at a particular atom site.*

- Right click on the atom and select the "symbol" option as shown below.
- Select the desired atom type, aromatic, aliphatic or R-group and a symbol will be displayed as shown below.

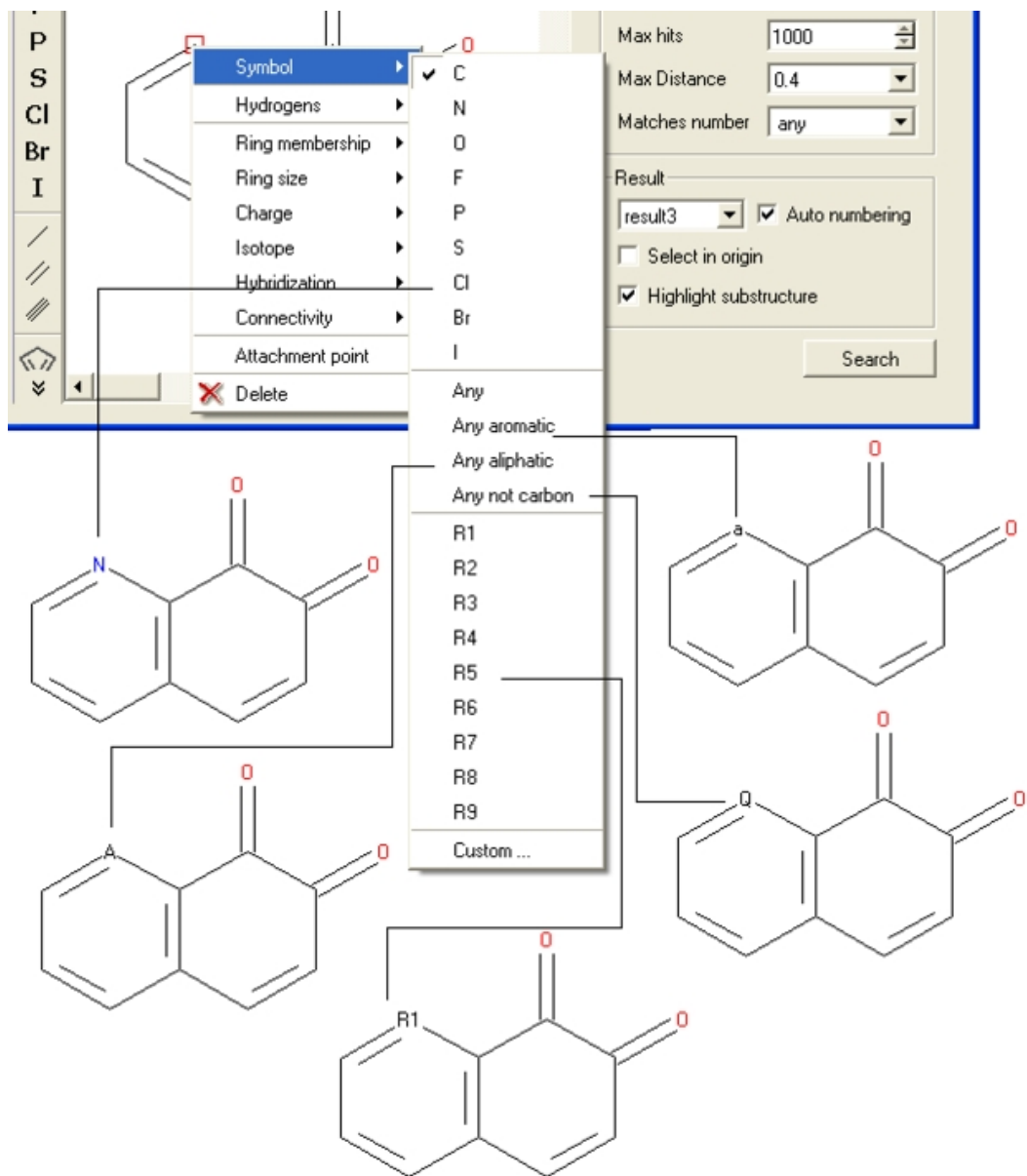

For example:

Query:

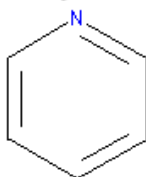

Right click atom - Symbol - N

Selection of chemical substructure search results

	1	2	3	4
0				

*To specify a particular number of hydrogen atoms at a particular site:*

- Right click on the atom and select the "Hydrogens" option as shown below.
- Select how many hydrogens you wish to specify and a symbol will be displayed as shown below.

*To specify the number of rings a particular atom will be a member of:*

- Right click on the atom and select the "Ring membership" option as shown below.
- Select whether the atom should be part of 1, 2 or 3 rings.

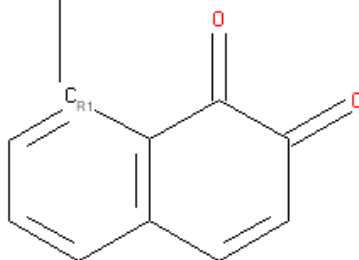
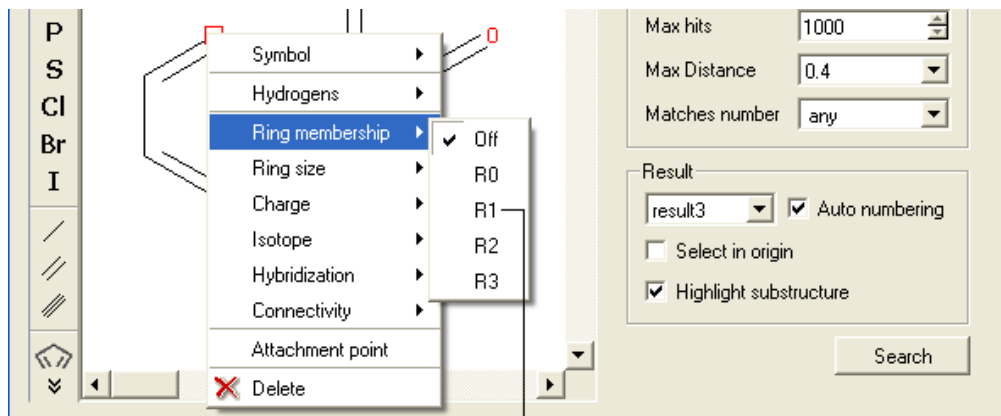

For example:

Query:

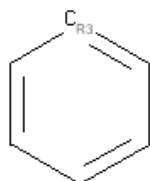

Right click atom - Ring Membership - R3

### Selection of chemical substructure search results

	1	2	3	4
24				

*To specify the ring size connected to an atom:*

- Right click on the atom and select the "Ring size" option as shown below.
- Select the size of the ring the atom should be connected to and a symbol will be displayed as shown below.

For example:

Query:

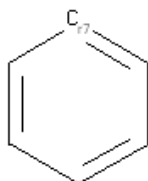

Right click atom - Ring size - R7

### Selection of chemical substructure search results

	1	2	3	4
0				

**To specify the charge at a particular point:**

- Right click on the atom and select the "Charge" option as shown below.
- Select the desired charge and a symbol will be displayed as shown below.



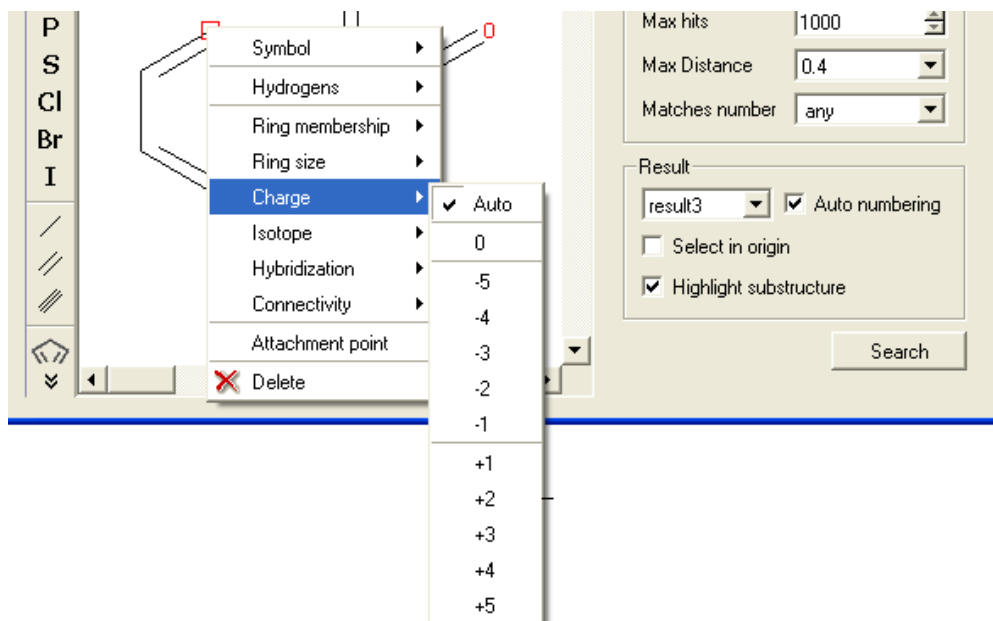

**To specify an isotope at a particular atom**

- Right click on the atom and select the "Isotope" option as shown below.
- Select the desired isotope from the list and a symbol as shown below will be displayed.

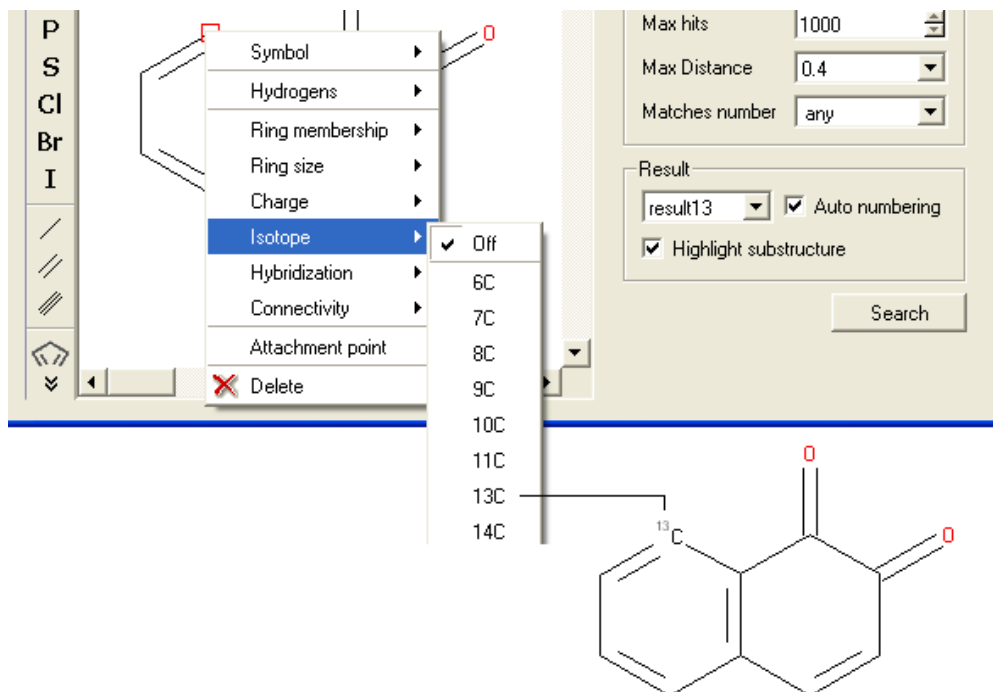

**To specify the hybridization state of the atom:**

- Right click on the atom and select the "Hybridization" option as shown below.
- Select the desired hybridization state and a symbol will be displayed as shown below.

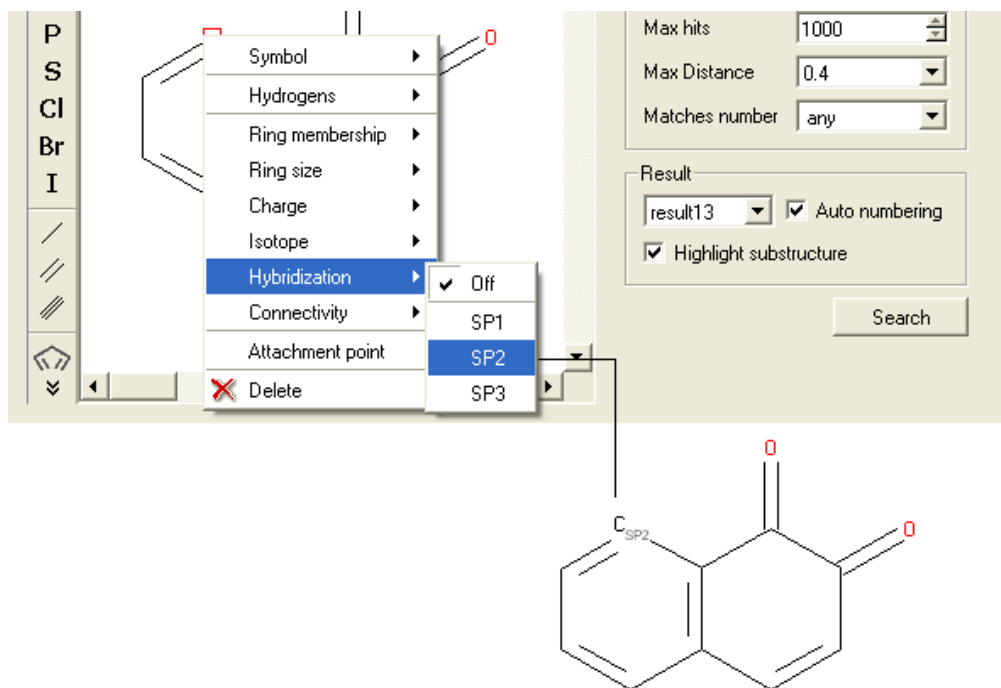

*To specify the number of atoms you wish an atom to be connected to:*

- Right click on the atom and select the "Connectivity" option as shown below.
- Select the number of atoms you wish the atom to be connected to and a symbol will be displayed as shown below.

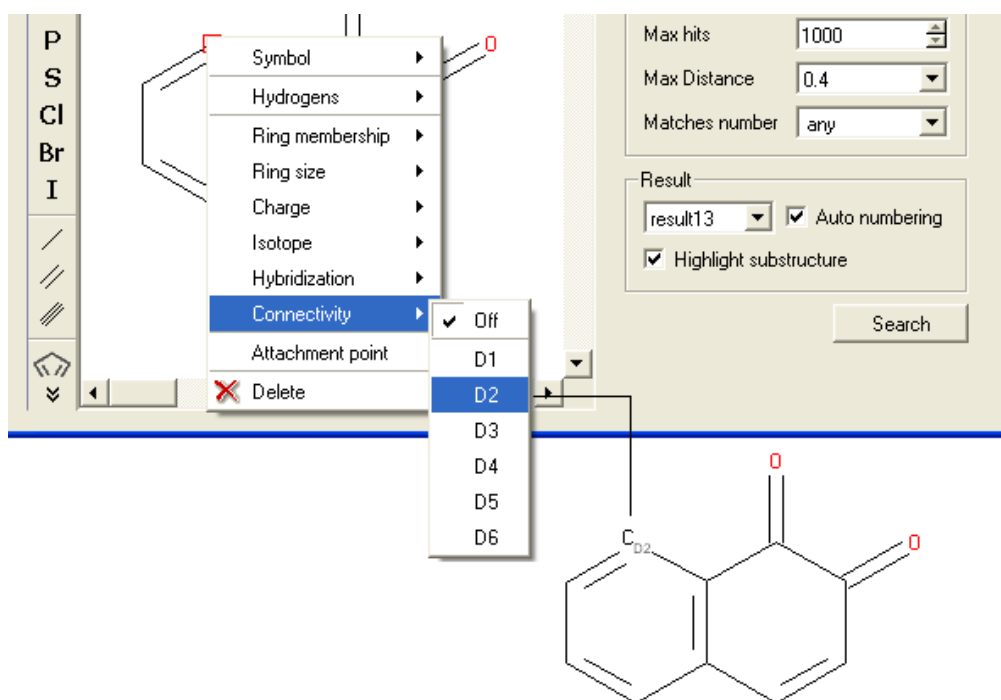

*To specify an attachment point – ie the position at which substituents will be added*

- Right click on the atom and select the "Attachment point" option as shown below.
- An asterisk representing the attachment point will be displayed next to the atom.

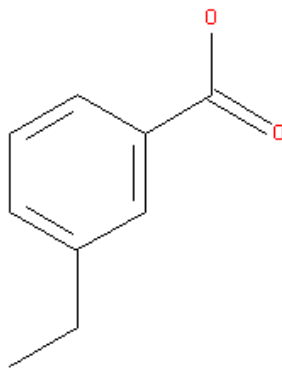

Attachment point 

An attachment point means that the atom can be attached to zero or more bonds to heavy atoms.

## 12.8.2 Filter Search

### *How to filter your query*

To filter your query:

- Right click in the box shown below and select 'Add Condition'

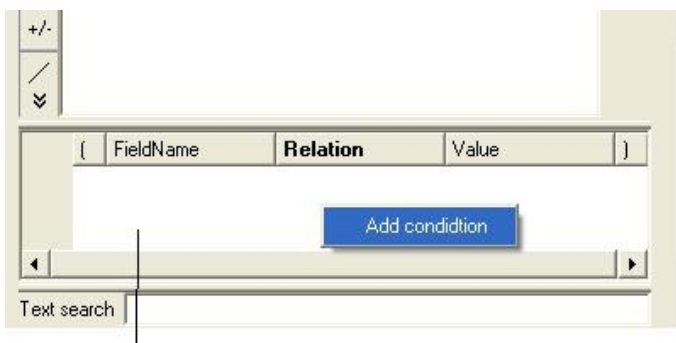

Right-click here and select Add Condition

To add conditions to your filter:

- Double click in the fields labeled "Name" and "Relation" and select the options from the drop down arrow or type in values.

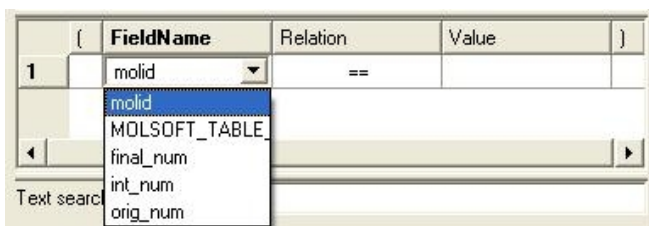

To remove a filter, right click on the filter and select 'Remove Filter'.

### *To exclude a fragment from your search*

Click on the option **Exclude fragment list**:

- Enter the SMART string of the fragment or use the Molecular Editor option to sketch the fragment.
- Click OK and the fragment will be listed at the bottom of the chemical search window as shown below.

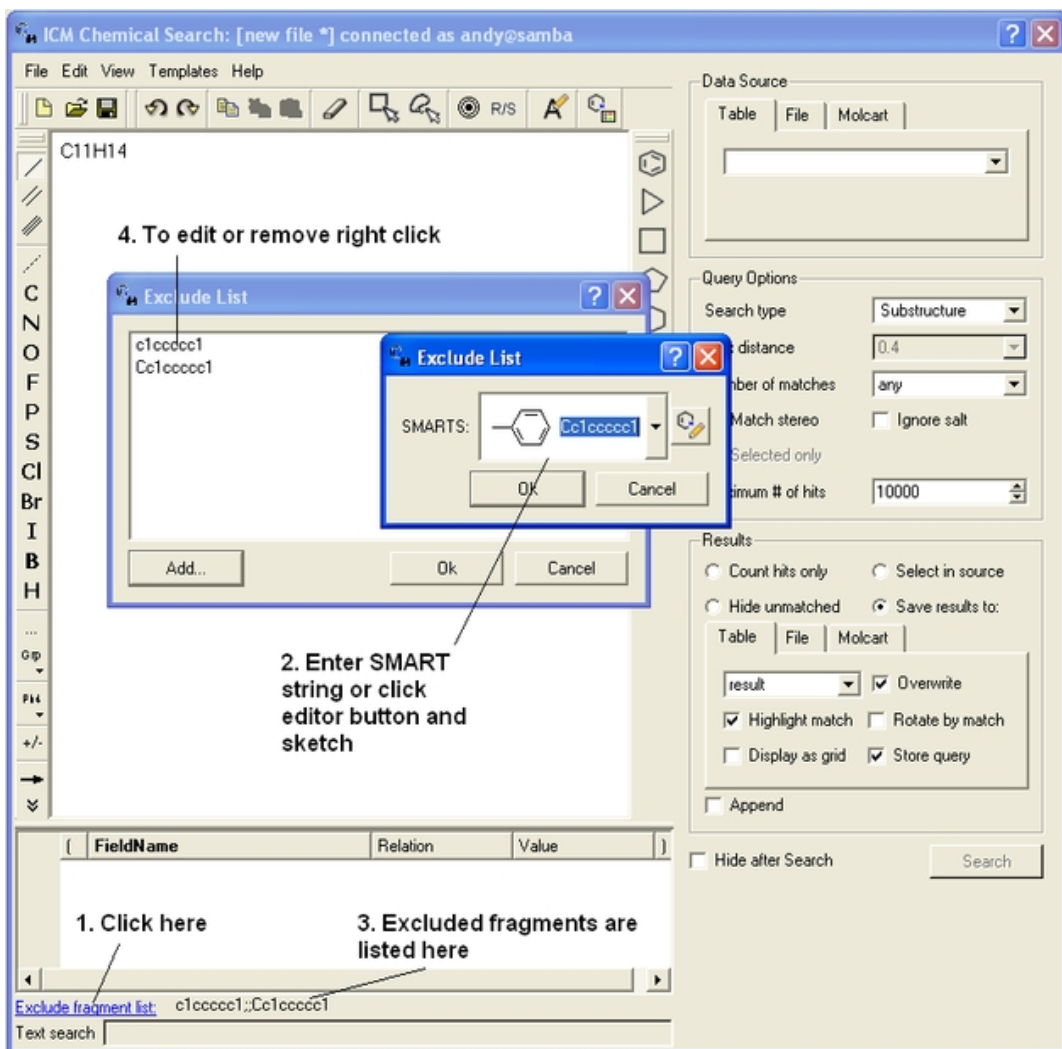

## 12.8.3 Query Processing

To begin processing your query first you need to decide which database to search. The options are listed in the **Data Source** section of the ICM chemical search window.

### Data Source

You can either search a **Table** - Chemical Spreadsheet a **File** - Local Database or **MolCart**.

If you select **MolCart** you first need to setup the link to the correct database.

- Enter the Server Name in which the database is stored.
- Enter the database name.
- Enter your username and password for the server.
- You can save these details so you don't have to re-enter this information each time you use the chemical similarity search.

If you are searching a **Table**, click on the **Table** tab and then select the drop down button where the names of your currently loaded tables are stored.

If you are searching a **File** click on the **File** tab and then locate your local database file .molt or if it is already loaded into ICM you can locate it with the drop down button.

## Query Options

*Now select a search type:*

- Click on the drop down arrow next to the "Search Type" option in the Query Options panel.
- Select the search type you want to use.

A **substructure** search is a search whereby only the defined molecule in the query will be searched against the database. Whereas, a **FP similarity** search which stands for fingerprint search enables any fingerprint within a structure to be searched for in the database.

The **Max distance** option is available for use with the FP search and the **Matches number** option is for use with the substructure search. The option you do not require based on your search method will be blanked out. A "Max distance" value of 0 means that the search will only identify matches exactly the same as the fingerprint – the default is 0.4. The "Matches number" option allows you to stipulate how many times within a structure in the database your query can be found.

You can match stereo by selecting the **Match stereo** option and **ignore salts**. If you make a selection of your query ICM can use that selection to search. How to make selections in the Molecular Editor are described here. Enter the Maximum number(#) of hits you would like returned.

## Results

Before processing the query determine how you would like your results displayed in the **Results** section of the **Chemical Search** window.

**Count hits only** – this option will count the number of hits and display this number in a window once the searching has been completed.

**Select in source** – If you are searching a table you can select and highlight the query in the source table that you are searching.

**Hide unmatched** – Hide unmatched will hide the compounds that were not matched from view.

**Save results to:** – this option gives you the option to save the output results to a Table– Chemical Spreadsheet a File –Local Database or MolCart.

**Append** – this option will allow you to append to current table, file or Molcart database.

## Search

- Click on the **Search** button to execute the search. You can choose to hide the window after the search.

### 12.8.4 Search a Database by Text

To search a database by text enter the text you wish to search in the **Text Search** data entry box at the bottom of the ICM Chemical Search window.

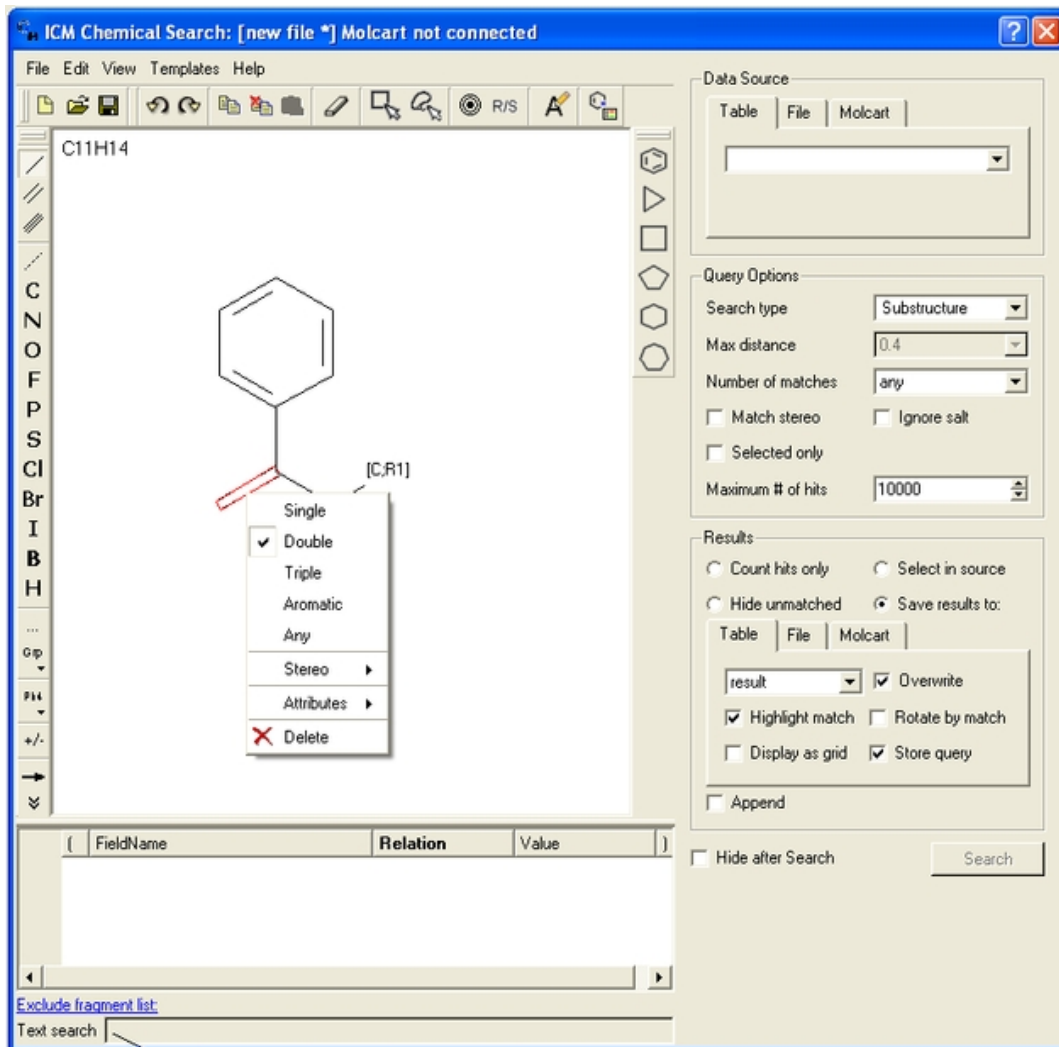

Enter text here

## 12.9 Pharmacophore Drawing and Searching

Pharmacophores can be drawn in 2D in the ICM Molecular Editor or in 3D in the Graphical Display. 2D pharmacophore sketches can be used to search chemical tables (spreadsheets) containing 2D or 3D coordinates. A 3D pharmacophore can be used to search chemical tables containing 3D coordinates only.

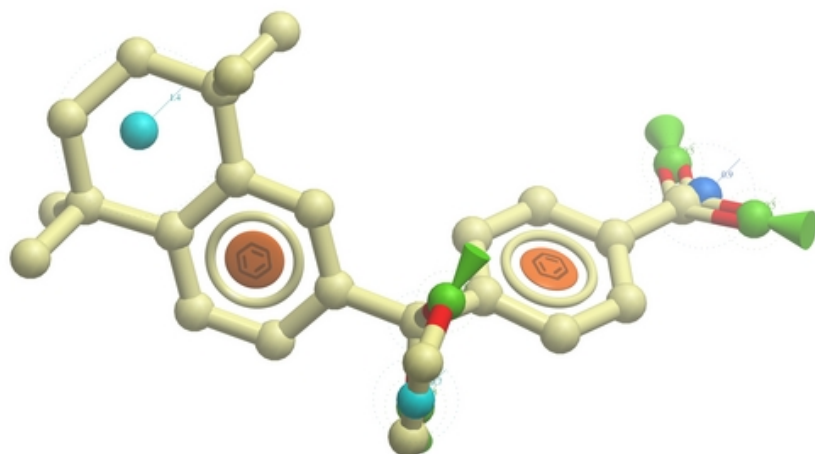

## 12.9.1 Pharmacophore Draw 2D

A 2D pharmacophore can be drawn using the ICM Molecular Editor or if you are going to use the drawing to search it is more efficient if you draw it in the Chemical Search window.

Use the distance bond button and the add pharmacophore group button to sketch the pharmacophore. The distance bond button represents the number of bonds between each pharmacophore point. You can edit the distance by right clicking on the bond and selecting edit. Other groups such as aromatic can be added using the standard molecular editor buttons.

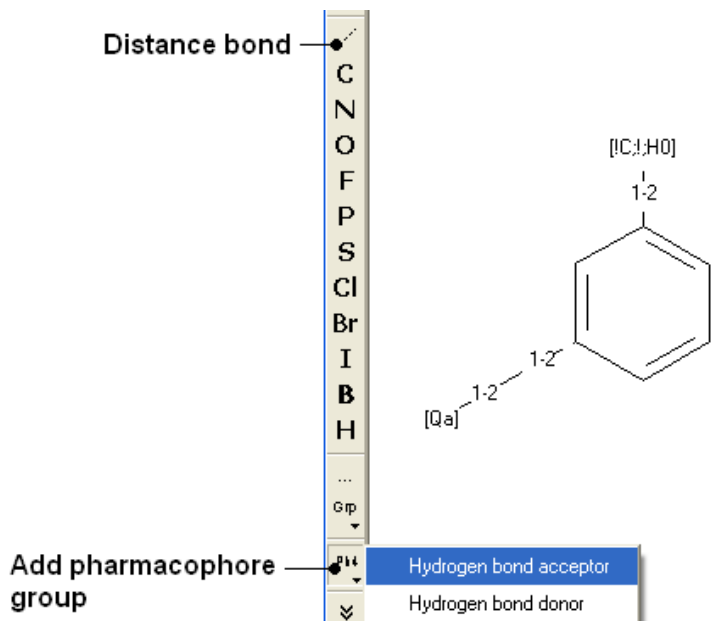

**NOTE:** Do not mix the 2D and 3D pharmacophore environment. For example do not edit a 3D pharmacophore in the 2D editor.

## 12.9.2 Pharmacophore Draw 3D

The easiest way to begin drawing a 3D pharmacophore is to draw a chemical in the ICM Molecular Editor which contains the key pharmacophore groups you want and then convert to 3D and extract the pharmacophore groups.

To draw a 3D pharmacophore this:

- Once the ligand is converted to 3D, right click on the ligand in the ICM Workspace.
- Select the option **Copy as Pharmacophore** and choose the **pharm centers** option.
- The pharmacophore groups or centers will then be displayed in the graphical display and can be displayed and undisplayed in the ICM workspace.

To move a pharmacophore group:

- Use the **drag atom** button (picture of a hand. See below)
- Click on the pharmacophore group and then drag.

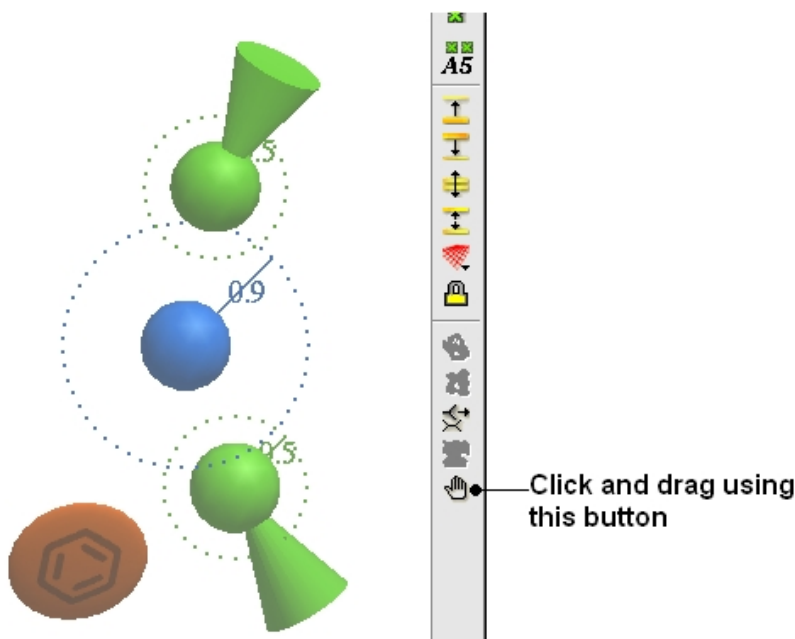

**NOTE:** Distances between groups can be monitored using the atom distance measurement tool. See Calculating the distance between two atoms.

To change a pharmacophore group:

- Right click on the pharmacophore group in the ICM Workspace or in the Graphical Display.
- Select **Pharmacophore/Edit Point**
- Choose the group from the drop-down list shown below.
- Enter the desired radius.



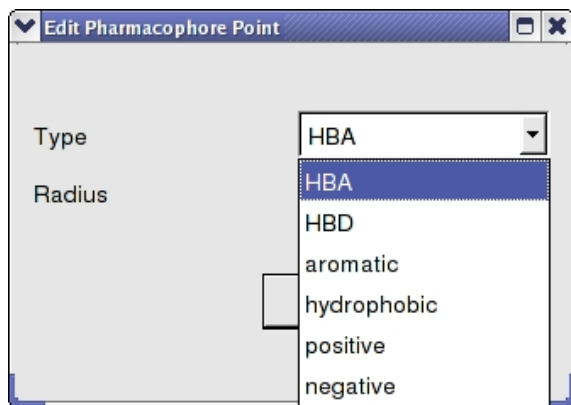

### *To make a new pharmacophore group:*

The easiest way to make a new pharmacophore group is to clone a pre-existing one. To do this:

- Right click on the pharmacophore group in the ICM Workspace or in the Graphical Display.
- Select **Pharmacophore/Clone Point**
- You can then move the new group as described above.

### *To change the direction of a pharmacophore group:*

- Right click on the pharmacophore group in the ICM Workspace or in the Graphical Display.
- Select **Pharmacophore/Assign Direction**
- You can then move the new group using the drag atom button described above.

### *To remove the direction of a pharmacophore group:*

- Right click on the pharmacophore group in the ICM Workspace or in the Graphical Display.
- Select **Pharmacophore/Remove Direction**

## Pharmacophore right click options

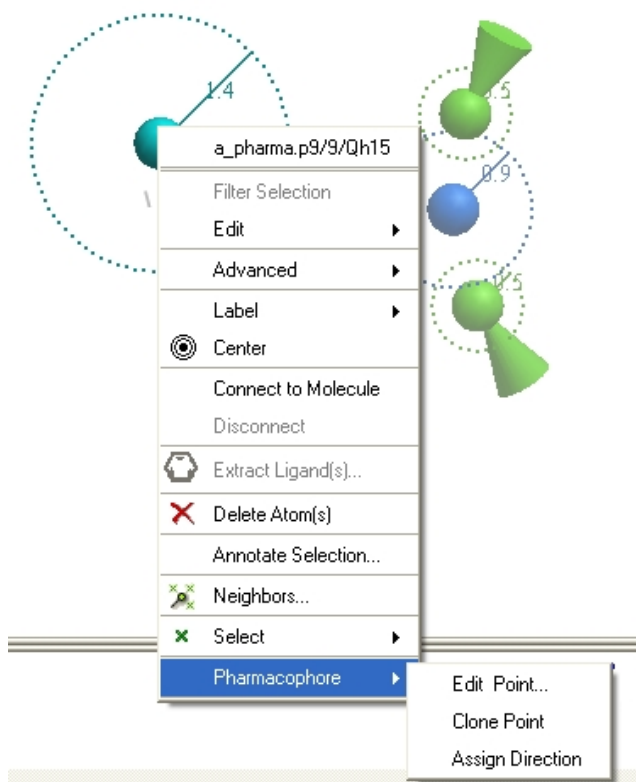

## 12.9.3 Pharmacophore Search

*To perform a pharmacophore search using a 2D pharmacophore:*

- Draw the 2D pharmacophore as described earlier in the Chemical Search window.
- Read in a molecular table to search or search a table in MOLCART.
- Select the chemical search options as shown below.
- Once the search has completed a new table with the results will be displayed.

Draw pharmacophore

Query Options

Database	
Table	t_3D
Search Type	Substructure
Maximal # of Hits	1000
Max Distance	0.4
Number of Matches	any
<input type="checkbox"/> Match stereo	<input type="checkbox"/> Ignore Salt
<input type="checkbox"/> By Selection	<input type="checkbox"/> # Of Hits Only

Select the table you wish to search here

*To perform a pharmacophore search using a 3D pharmacophore:*

- Right click on the pharmacophore in the ICM Workspace
- Select **Search Pharmacophore**
- Use the drop-down button to select the table you wish to search. The table must contain 3D coordinates.

Right click here

pharma

- Clear Default Display...
- Edit Description...
- Edit
- Search Pharmacophore...
- Advanced
- Center
- Connect to Object

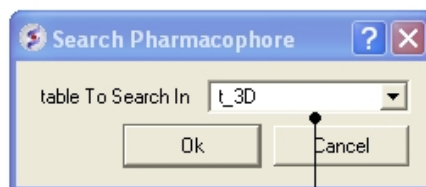

Enter name of table containing 3D coordinates

example\_pH4\_xcb Molsoft Chemist 3.4.1g [C:\Program Files\Molsoft\LCVCM\Pro\example\_pH4\_xcb] [2 objects 1 table]

How to send a 3D pharmacophore search query.

1. Right click on the pharmacophore points in the ICM Workspace and select "Search Pharmacophore"

2. Search a table with chemicals that have 3D coordinates

The screenshot shows the Molsoft Chemist 3.4.1g interface. The workspace displays a 3D model of a ligand with its pharmacophore points highlighted. A context menu is open over the pharmacophore points, and a green arrow points from the menu to the search query text. The table below shows search results for chemicals with 3D coordinates.

no	name	molwt	confid	L	D	7
1			5	438	0	7
2			4	438	0	7
			5	440	0	5

## 12.9.4 How to extract a 3D pharmacophore from a ligand.

pharma Molsoft Chemist 3.4.1g [NewProject \*] [2 objects]

How to extract a 3D pharmacophore from a 3D ligand.

1. File/Open 3D ligand or read in PDB

2. Right click on 3D ligand and select "Extract pharmacophore"

3. Display and undisplay pharmacophore types

The screenshot shows the Molsoft Chemist 3.4.1g interface. The workspace displays a 3D model of a ligand with its pharmacophore points highlighted. A context menu is open over the 3D ligand, and a green arrow points from the menu to the search query text. The table below shows search results for chemicals with 3D coordinates.

no	name	molwt	confid	L	D	7
1			5	438	0	7
2			4	438	0	7
			5	440	0	5

## 12.9.5 How to color a 2D chemical sketch by pharmacophore feature.

How color a 2D chemical sketch by pharmacophore feature.

2. Select Color Structure By/ By Pharmacophore Features

1. Right click on column header

NAME	SCORE	NUM	SCORE	L	SCORE
1	100	100	100	0.00795	100
2	100	25603	0.018	100	

## 12.10 Find and Replace

Chemical Findtool allows you to find an arbitrary chemical fragment with one or more attachment point(s) and replace it with another fragment with the same number of attachment points.

*To find a substructure and replace it with something else:*

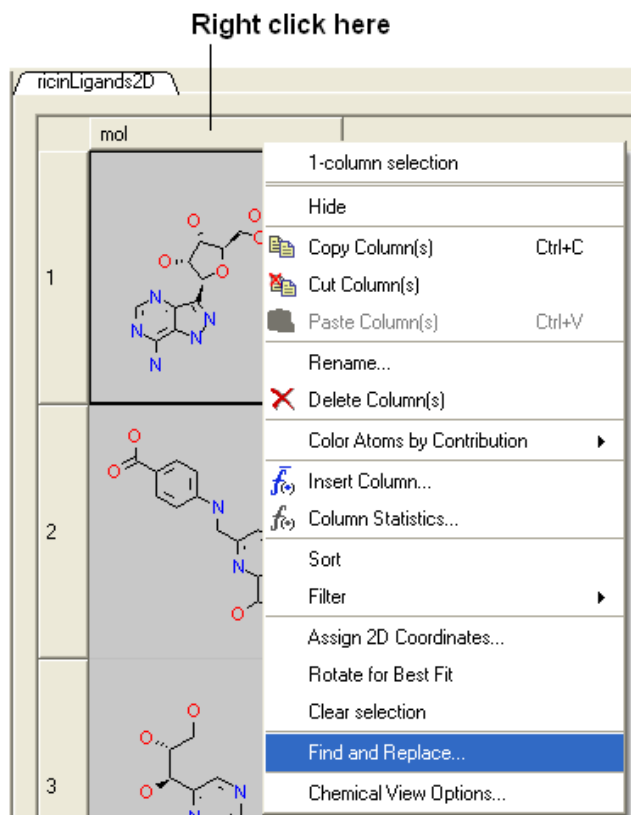

- Select the column in which the molecular structures are displayed. The column is usually called "mol".
- Right click on the "mol" column header and select Find and Replace. A data entry box as shown below will be displayed.

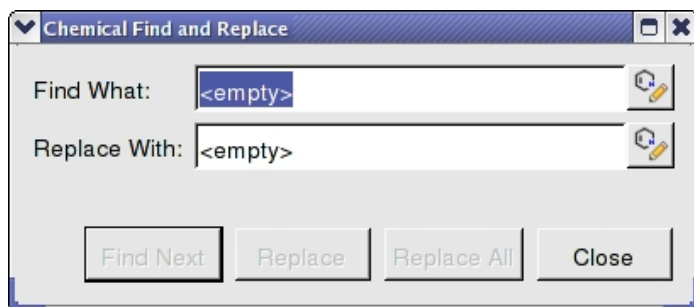

- Click on the Molecular Editor button at the end of the Find What: data entry box.
- The ICM Molecular Editor will be displayed. Draw the substructure you wish to search for and replaced.
- Draw the pattern and mark attachment points with R1,R2.... R-groups can be added by right clicking at the attachment point and selecting the R-group from the drop down options.
- Close the ICM Molecular Editor and the string will be displayed.
- Repeat with the "Replace With:" data entry box. Make sure the same number of R1,R2... labels are drawn.
- Click the Find Next button and then Replace or Replace All. When a substructure to replace is identified it will be colored red.

**NOTE:** There are a number of keyboard shortcuts which can be used to draw chemicals. Also please note that an aromatic bond in the source molecule will not match a double bond in the replacement pattern.

Here is an example:

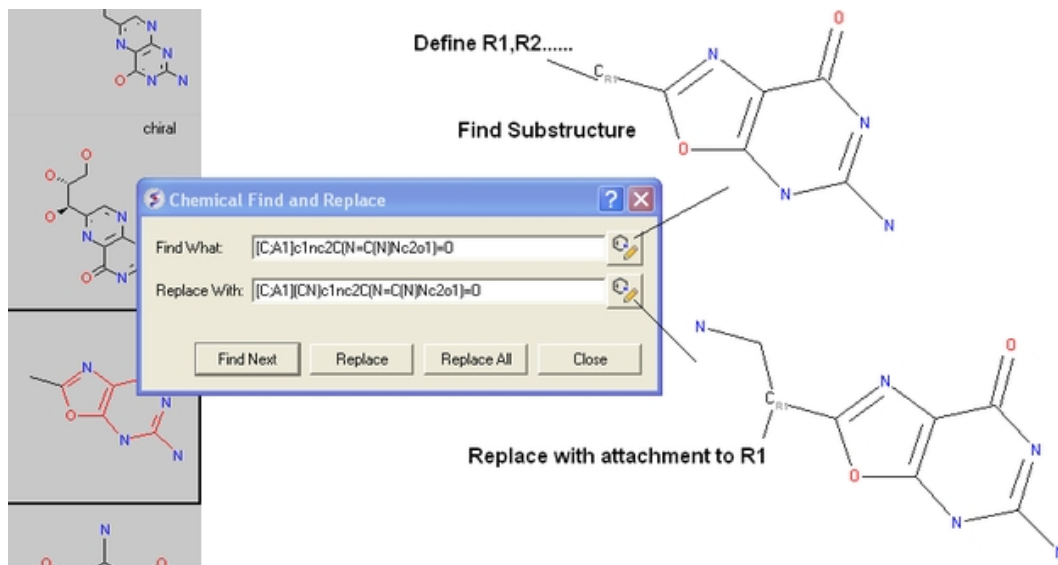

## 12.11 Generating Chemical Fragments

Chemicals displayed in an ICM Molecular Table can be split into fragments. This is useful for generating a series of R-groups to be added to a scaffold (See section describing reactions).

To generate fragments:

- Select the column or row(s) you wish to generate the fragment from.
- Right click on the "mol" column header and select "Split Into Fragments".
- A new table of chemical fragments will be displayed. Each fragment is assigned an attachment point which is flagged with an asterisk (\*).

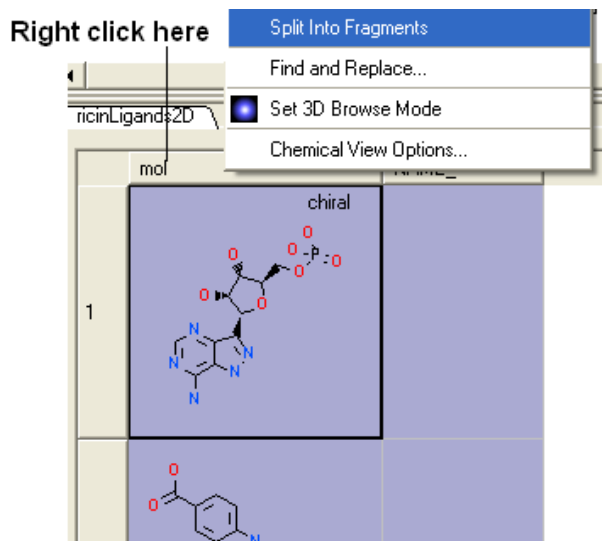

New table is generated containing fragments

ricinLigands2D R\_R1

mol	cnt	n_apo
<p>Attachment Point</p>	1	1
chiral	1	2

## 12.12 Molcart

Molcart is an enterprise wide chemical management system. Compound databases of any size can be stored in MolCart and analyzed and searched using ICM cheminformatic tools.

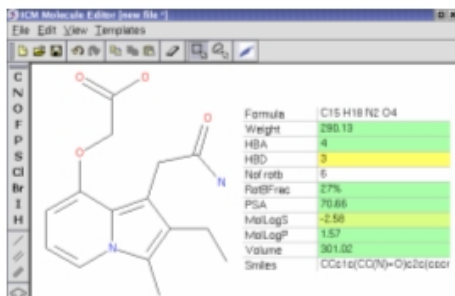
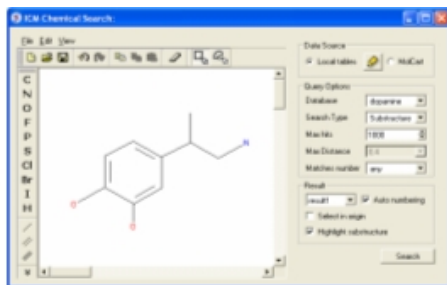
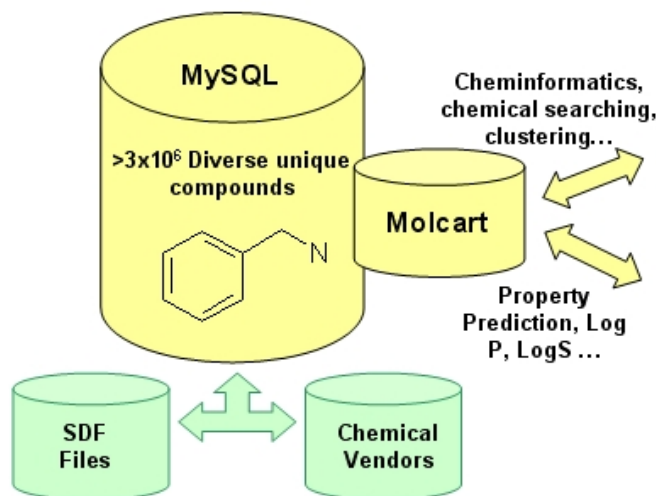

## 12.12.1 Molcart Installation

In order to run MolCart it is necessary to install the FREE OPEN SOURCE MySQL database on your machine. Please see your systems administrator or see <http://dev.mysql.com/downloads/>

### Linux Installation

**MySQL:** Check if mysql daemon is running :

```
/etc/init.d/mysql status
```

If you see that the MYSQL service is unused (not running), you need to start the mysql daemon. Become root and do the following:

```
/etc/init.d/mysql start
```

### Download and install Molcart files.

The MolCart package is a self-extracting executable file.

Installation Instructions:

- Download the MolCart file ( molcart-version-platform.sh ) from the Molsoft website.
- Type in a shell window: `./molcart-version-platform.sh -p=THE_PATH_YOU_WANT_TO_DOWNLOAD` (NOTE: You must be logged in as 'root' to install the 'molcart-version-platform.sh' to '/usr/molcart-version-platform')
- The following question will be displayed: Do you want to install the molcart-1.6-6 to "/usr/molcart-1.6-6" now? (y/n) [y]
- Answer YES and the unpacking process will begin
- You will now be prompted for a password.
- Select which default databases you wish to install.
- Make a note of the HOSTNAME, DATABASE NAME and USER NAME
- MolCart is now fully installed.

### Mac Installation

System requirements: \* Mac OS 10.3 \* MySQL server for Mac OS 10.3

To install Molcart on the Mac just run this:

```
sudo /some/path/molcart-1.6-6-darwin.sh
```



## 12.12.2 Molcart Getting Started

### *To start Molcart*

#### Tools/Connect Molcart

Once you have activated MolCart the loaded databases and users will be shown in the ICM Workspace as shown below.



All the records and fields contained within each database can be viewed by expanding the tree structure in the ICM Workspace.

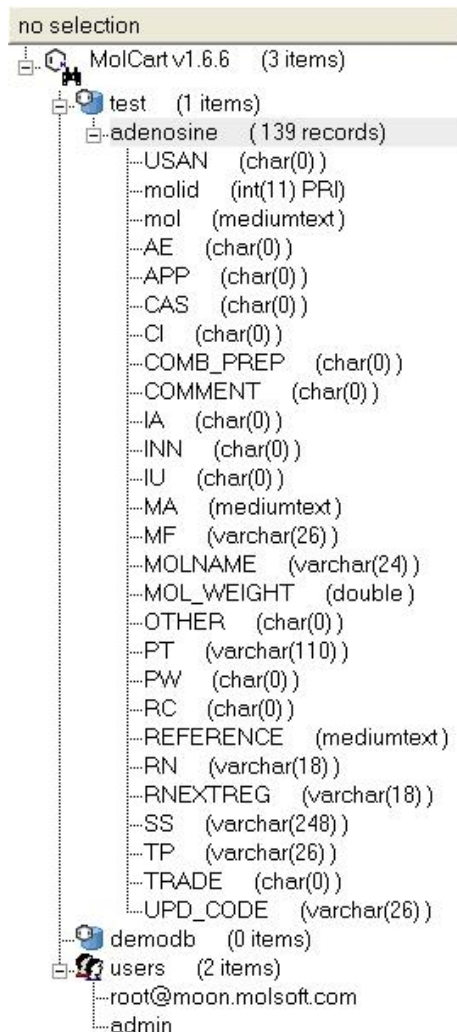

## 12.12.3 Molcart Search

### *How to search the databases contained within MolCart*

Click on the button shown below.



### MolCart and Chemical Search Tools

To begin processing your query first you need to decide which database to search. The options are listed in the "Data Source" section of the ICM chemical search window.

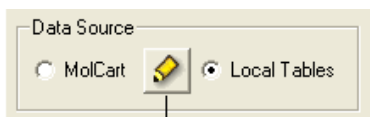

**To connect to MolCart database for the first time  
click here.**

You can either search a local table (molecular table) or you can search MolCart.

If you select MolCart you first need to setup the link to the correct database – described earlier. Click on the button shown above (yellow pencil) and the Connect to Molcart window will be displayed as shown below.

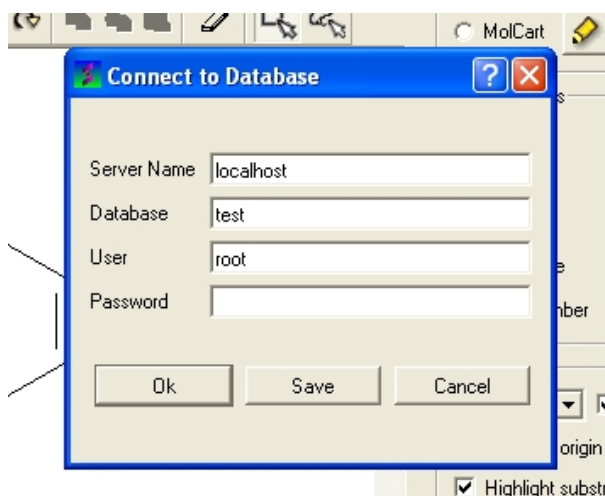

- Enter the Server Name in which the database is stored.
- Enter the database name.
- Enter your username and password for the server.
- You can save these details so you don't have to re-enter this information each time you use the chemical similarity search.

See the Chemical Search section of this manual on the many different search procedures.

### ***How to perform a text search***

To perform a text search on one of the databases contained within Molcart you first need to index the text within the database and then search using the query option.

To make the database index, see text and picture below:

- Expand the tree of the database in the ICM Workspace.
- Select the column headers you wish to search which contain Full Text or Partial Text (the data type for each column is listed next to the column name). Multiple column headers can be selected by clicking and holding down the CTRL key. A range of column headers can be selected by holding down the shift key and clicking to select.
- Next, right click and select Create Index.

- Select 'Full Text' and you will notice an additional header in the ICM Workspace called 'indices'. The value in the items category represents the number of columns you have chosen to text search.

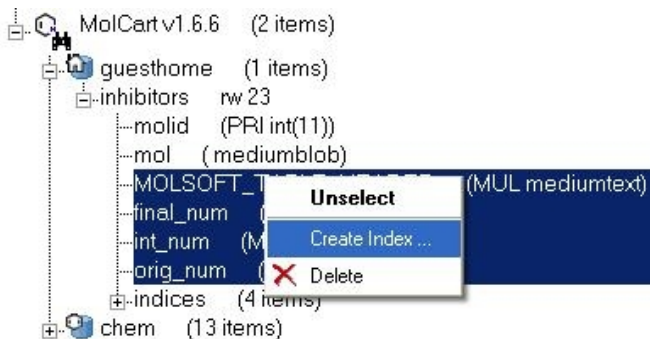

### ***To perform the text search:***

- Right click on the database name in the ICM Workspace.
- Select 'Query' as shown below.

The options are:

- Display results – displays your model in the 3D graphics window
- Minimize side chains – performs minimization on the side-chains
- Sample side chains – performs monte-carlo optimization on the side chains
- Write object to file – writes your new model as an ICM object

### ***To build your model:***

- Click OK

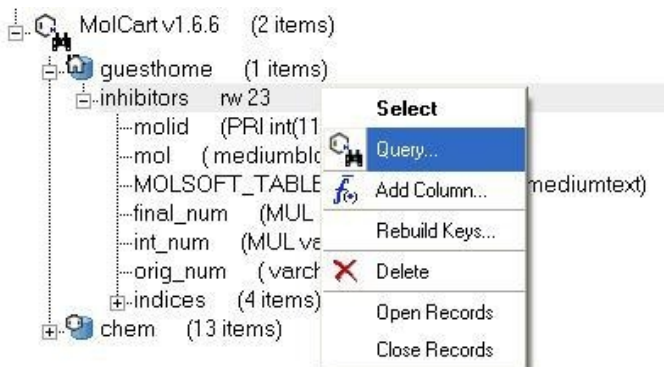

The ICM Chemical Search query window will be displayed as shown below. Type your query text in the space provided and hit the enter key or click on the search button.

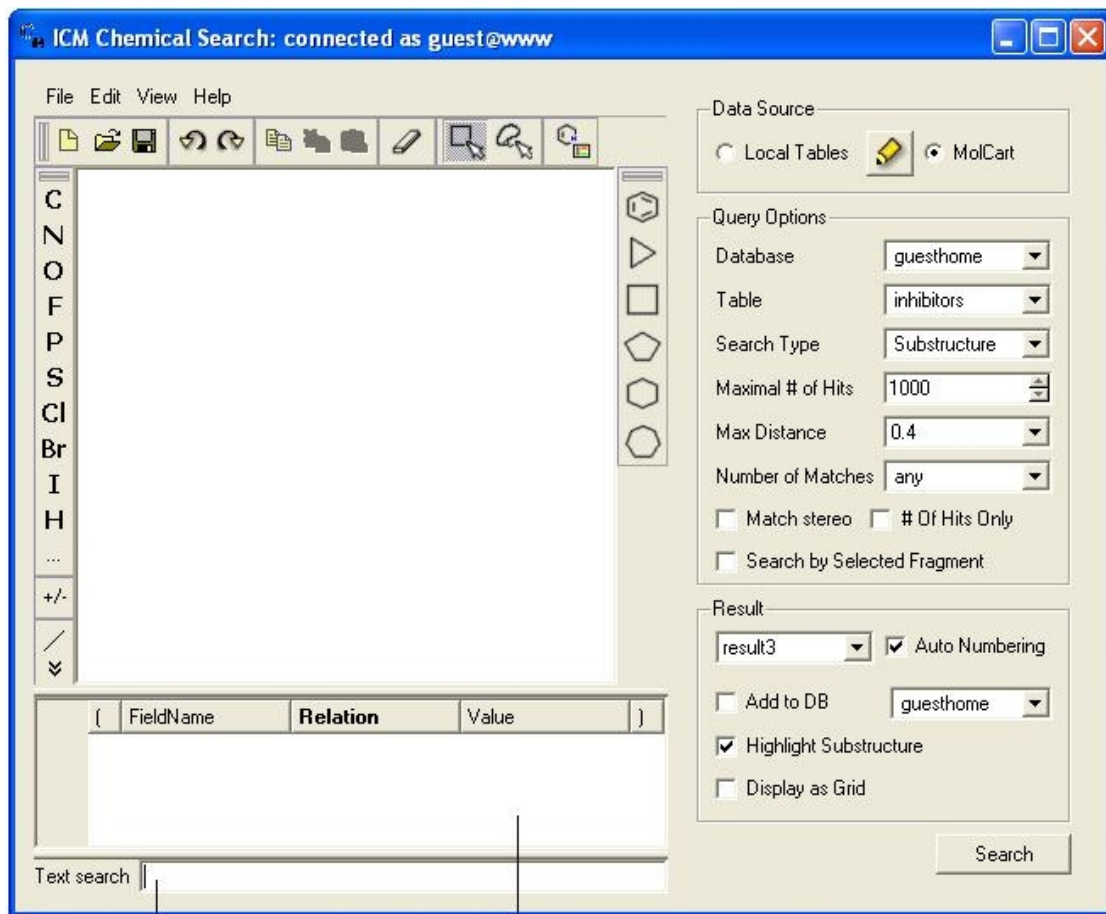

Type text search query here      Filter your search here

### How to add conditions to your query

- Right click in the box shown below and select 'Add Condition'. You can add as many conditions as you like.

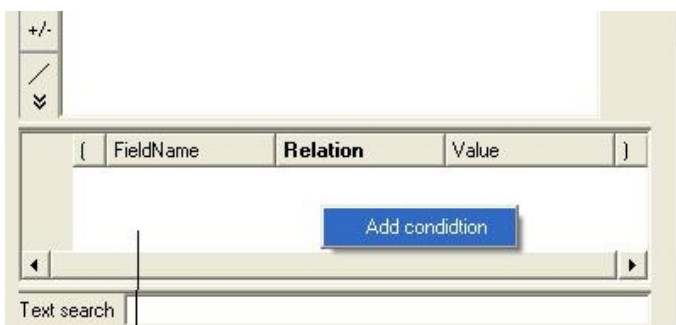

Right-click here and select Add Condition

- Double click in the fields labeled "Name" and "Relation" and select the options from the drop down arrow or type in values.

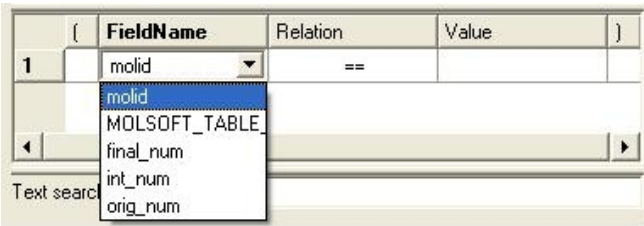

To remove a condition, right click on the filter and select 'Remove Filter'.

## 12.12.4 Molcart Administration

### *Edit Password*

- Right click on the MolCart header in the ICM Workspace and select Change Password.

### *Add a New MolCart User – Root Only*

- Right click on the User Section of MolCart in the ICM Workspace as shown below.



- Select the New User Option.
- Add new username and password in the data entry box.
- New user will be displayed in the ICM Workspace.

### *Edit User Privileges – Root Only*

- Right click on the user in the ICM Workspace.
- Select Edit Privileges and a data entry box as shown below will be displayed.



- Select the database name.
- Edit the privileges by checking or unchecking the appropriate boxes.

### *Add a New Database*

- Right click on the MolCart Header in the ICM Workspace as shown below.

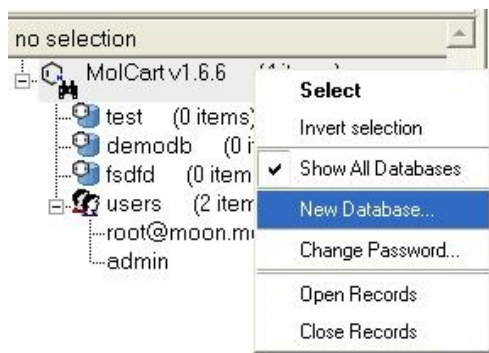

- Select the New Database option.
- Enter a unique name for your new database.
- The new database name will appear in the ICM Workspace.
- Now you need to add data to your new database (See Instructions Below).

### Add New Data to Database

- Right click on the database name in the ICM Workspace as shown below.

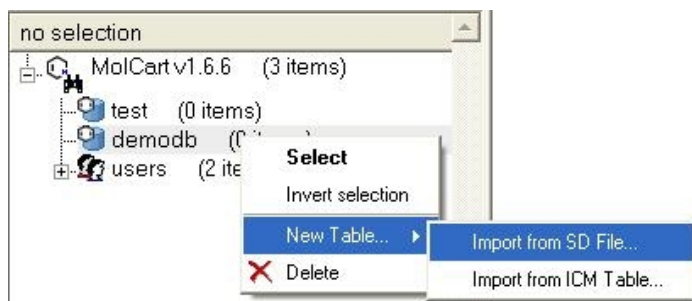

- Select New Table.
- Select either Import from SD file or Import from ICM table.
- Select the appropriate file and the records structure of your sdf or ICM table will be displayed as shown below.

Field Name	Checked	Data Type	Value
AE	<input checked="" type="checkbox"/>	String	3769
APP	<input checked="" type="checkbox"/>	String	0
CAS	<input checked="" type="checkbox"/>	String	16
CI	<input checked="" type="checkbox"/>	String	145
COMB_PREP	<input checked="" type="checkbox"/>	String	1638
COMMENT	<input checked="" type="checkbox"/>	String	0
IA	<input checked="" type="checkbox"/>	String	472
INN	<input checked="" type="checkbox"/>	String	0
IU	<input checked="" type="checkbox"/>	String	760
MA	<input checked="" type="checkbox"/>	String	1082
MF	<input checked="" type="checkbox"/>	String	38
MOLNAME	<input checked="" type="checkbox"/>	String	24
MOLSOFT_TABLE_HEADER	<input checked="" type="checkbox"/>	String	192
MOL_WEIGHT	<input checked="" type="checkbox"/>	Real	8

- The database name can be changed at this point and the fields contained within the database can be altered. Certain fields can be excluded by checking the boxes – this will help in minimizing the size of a database. Caution must be taken if you want to change the field type or length.
- Click OK and your sdf file or ICM table will be added to the database. This can be seen by expanding the tree structure in the ICM Workspace.

#### ***Delete a Database or User***

- Right click on either the database or user in the ICM Workspace.
- Select Delete.





# 13 Chemistry Menu

**Note:** Click **Next** (top right hand corner) to navigate through this chapter or use the links below. Headings are listed on the left hand side (web version) or by clicking the **Contents** button on the left-hand-side of the help window in the graphical user interface.

## Chemistry Menu

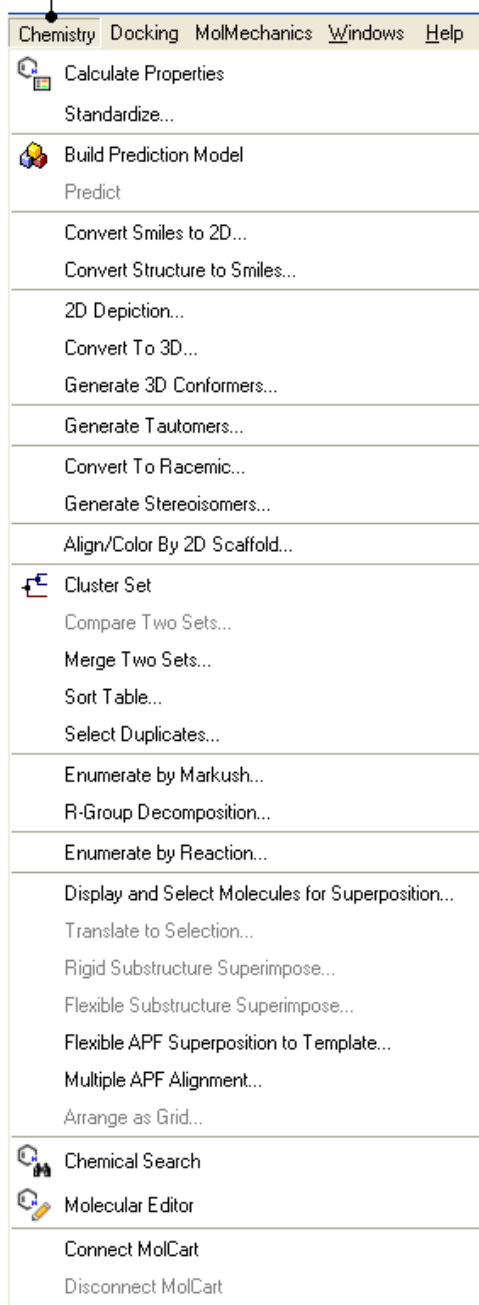

## 13.1 Calculate Properties

*To calculate chemical properties for compounds within a chemical table:*

- Read in the chemical table.

- Select **Chemistry/Calculate Properties** and a window as shown below will be displayed.
- Select the properties you wish to calculate using the 'tick' check boxes.
- Click OK and the properties will be added as new columns in the chemical table.

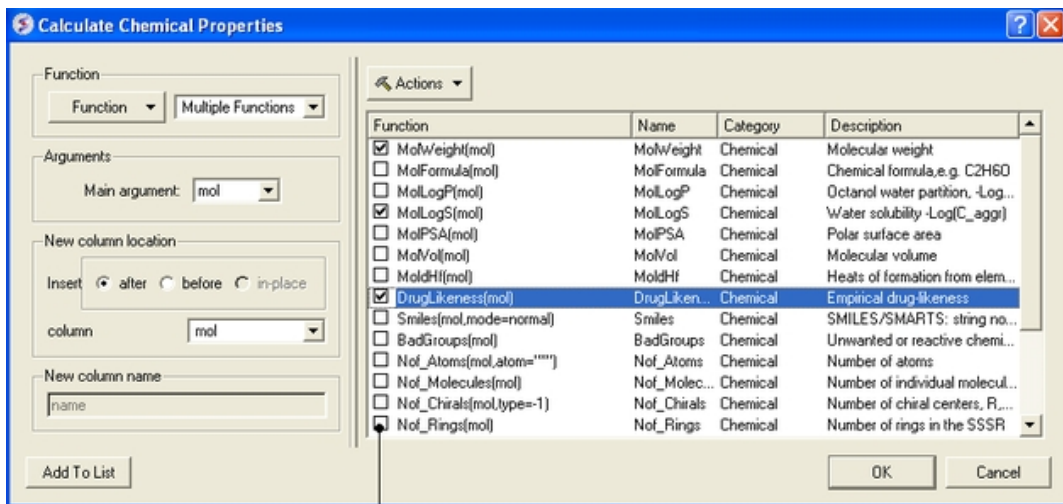

Select properties here

## 13.2 Standardize Table

**NOTE:** Before standardizing a chemical you may want to make a copy of the original so you do not lose any information. You can do this by right clicking on the name tab of the table and selecting **clone** or **save as**.

*To remove salts, explicit hydrogens and standardize groups in a chemical table:*

- Chemistry/Standardize
- Select the table from the drop-down list. This will also work for selections made on the table.
- Select option – Remove Salts, Remove Explicit Hydrogens or Standardize Groups
- Click OK.

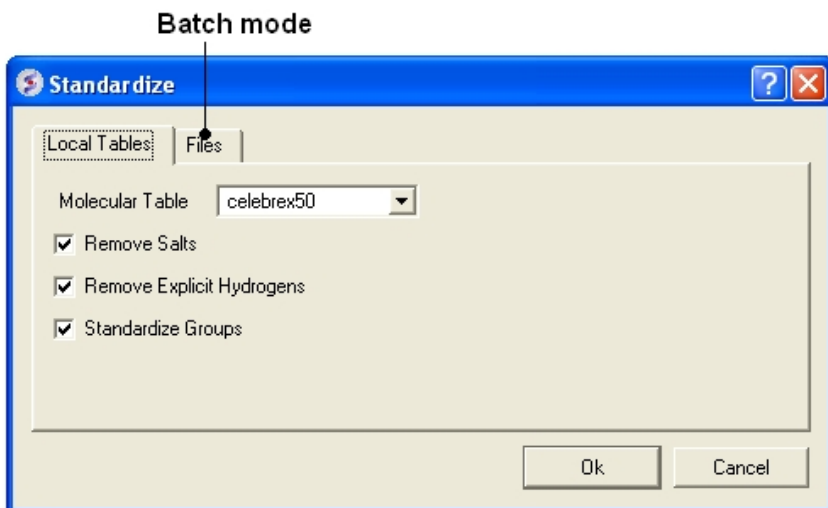

Standardize chemical groups will apply rules from ICMHOME/CHEMNORMRULES.tab For example some chemical groups may have different representations e.g. [N+] (=O)O versus N(=O)=O

*To run in batch mode:*

- Chemistry/Standardize

- Select the **Files** tab
- Enter the path and name of the sdf file you wish to standardize or use the browse button.
- Enter the path and name of the output file or use the browse button.

*To remove a salt from an individual row in a chemical table:*

- Select the row or rows.
- Right click – Chemistry/Remove Salt (Selected Row)

## 13.3 Annotate By Substructure

This feature allows you to annotate a chemical spreadsheet according to functional group. It also allows you to flag substructures which may have poor ADME properties.

*First read in a chemical spreadsheet or sdf file you wish to annotate. To do this:*

- File Open. More information on the chemical structures can be found [here](#).

*To annotate functional groups:*

- Chemistry/Annotate by Substructure.
- Enter the name of the Molecular Table (Chemical Spreadsheet) or use the drop down button to locate it.
- Check the **Functional Groups** option.
- The functional groups will be listed in a new column in your chemical spreadsheet called **funcgroup**. The default table with functional group will be used for annotation called FUNCGROUPS.sdf in ICMHOME.

*To annotate potentially poor ADME groups (Substructure Alert).*

- Chemistry/Annotate by Substructure.
- Enter the name of the Molecular Table (Chemical Spreadsheet) or use the drop down button to locate it.
- Check the **Substructure Alerts** option.
- The alerts will be listed in a new column of your chemical spreadsheet called **alerts**. The default table with substructure alerts will be used for annotation called CHEMFILTER.sdf

## 13.4 Align/Color by 2D Scaffold

This option **aligns** a set of sketches in a chemical table in the same orientation according to a defined scaffold or **color** by a common substructure.

- Chemistry/Align–Color by 2D Scaffold
- Choose a loaded molecular table from the drop–down arrow.
- Draw a new scaffold using the molecular editor or choose the scaffold from a table (Index = row number).
- You can then **Align** or **Match All** the substructure and color.
- If coloring has already applied to the molecule then this new coloring by scaffold can be appended.
- Select **color** for common scaffold.

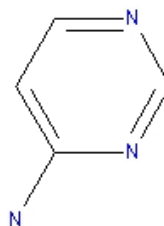
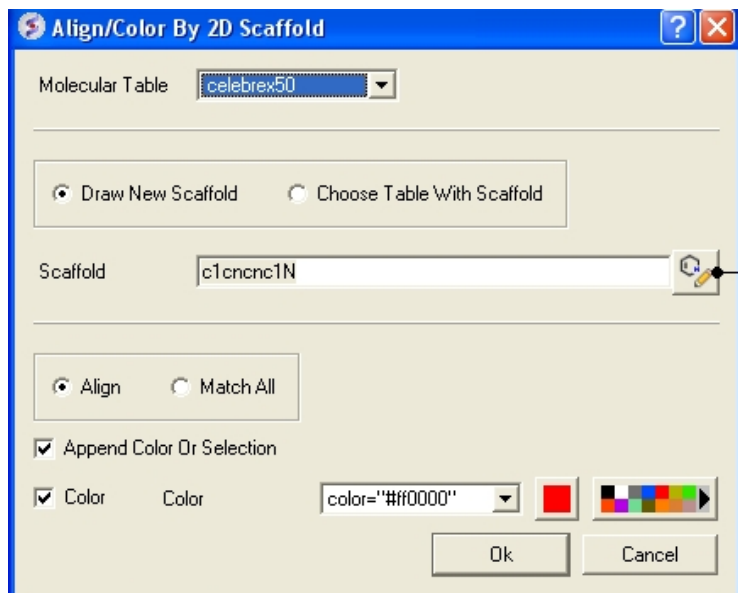

Draw scaffold using molecular editor

## 13.5 Set Formal Charges

To set formal charge:

- Read in a chemical spreadsheet (File/Open SDF)
- Chemistry/Set Formal Charges
- Enter the name of the chemical spreadsheet (table)
- Choose the option to either make **Charge**, **Make Neutral**, or Charge according to ICM pKa Model
- Select the groups you want to charge or neutralize.

## 13.6 Convert

### 13.6.1 3D to 2D Depiction

If you have a chemical table displayed containing 3D coordinates or you wish to reassign the 2D coordinates in an sdf file you can use this option.

- Read a chemical table (sdf file) into ICM.
- Chemistry/Convert/2D Depiction
- Enter name of loaded chemical table.
- Choose **In Place** if you want to overwrite the table.
- Choose the **Files** tab to run in batch mode.

Table contains 3D coordinates

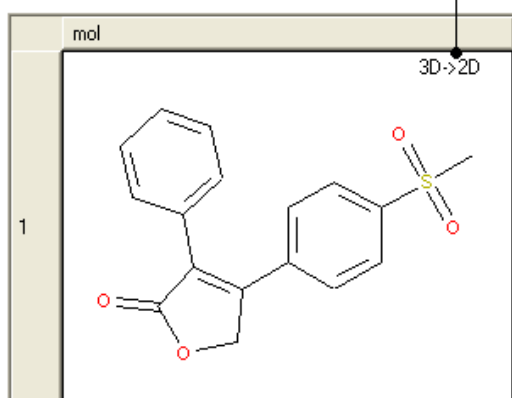

## 13.6.2 Convert Smiles to 2D

*To convert smiles strings to 2D sketches*

- Read in a table containing the smiles strings in separate rows. For example the smiles strings maybe in an Excel file and you can load this into ICM by saving the Excel file as comma-separated (csv).
- Select **Chemistry/Convert/Smiles to 2D**.
- Select the table you want to convert using the drop down arrow and the name of the column containing the smiles string.
- Select whether you wish to keep the smiles column in the new table.
- Click OK and a table will be displayed containing the 2D structure.

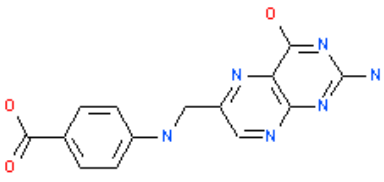
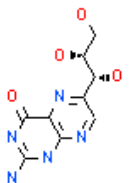
ricinLigands2D	
mol	smiles
2	 <chem>C1(C=NC(=C(N=1)C1O)N=C(N=1)N)CNC(=CC=C(C1)C(O)=O)C1=O</chem>
3	chiral  <chem>C(C1=O)(=C(NC(=N1)N)N=CC1[C@H]([C@@H](CO)O)O)N=1</chem>

## 13.6.3 Convert Structure to Smiles

*To convert an sdf file of 2D or 3D chemical coordinate in Smiles:*

- Read a chemical table (sdf file) into ICM.
- Select **Chemistry/Convert Structure to Smiles**.
- Select the table you want to convert using the drop down arrow and the name of the column containing the 2D sketch.
- Select whether you wish to keep the 2D sketch column in the new table.
- Click OK and a table will be displayed containing the smiles string.

## 13.6.4 Convert to Racemic

*To remove stereo bonds and make all chemical centers R/S in a chemical table:*

- **Chemistry/Convert to Racemic**
- Select the Molecular Table
- Select **In Place** if you wish to overwrite the table.



**NOTE:** To reassign stereo bonds use the `Generate Stereoisomers` option

## 13.7 Predict

To make a prediction using a model you need either ICM-Pro + Chemistry or ICMChemistPro.

Read the table of data into ICM from which you wish to predict. Make sure the table contains the same columns used for the learn model.

- Tools/Table/Predict
- Select which table you wish to make the prediction on.
- Select which model you wish to use.
- Check that the required columns are in the table. If they are absent a red mark will appear against the column that is missing.
- Click Predict.

## 13.8 Generate Tautomers

### Theory

Tautomers are formed by an interconvertible reaction called tautomerization whereby there is a formal migration of a hydrogen atom along with a switch of a single bond and an adjacent double bond. A common example is the keto to enol tautomerism:

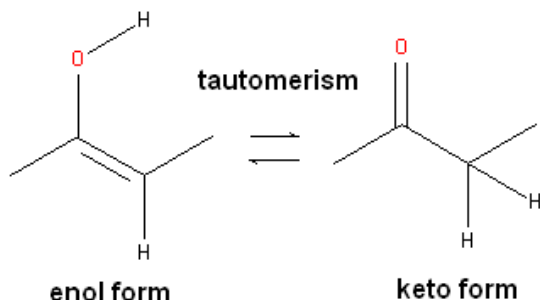

During tautomerization a chemical equilibrium of the tautomers will be reached based on several factors, including, pH, temperature and solvent. Tautomerizations are catalyzed by: bases (deprotonation, formation of a delocalized anion, and, protonation at a different position of the anion; and acids (protonation, formation of a delocalized cation, and deprotonation at a different position adjacent to the cation).

ICM will only generate energetically favorable tautomers. Generally tautomers that have a change in hybridization state are less stable and so ICM will not generate these thus reducing the number of scaffolds generated. For example the keto form shown below is more stable by ~14 kcal.mol than the enol therefore ICM will not generate the enol form.

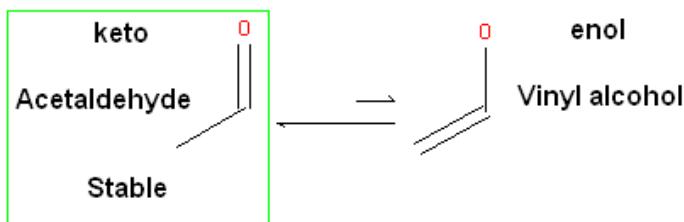

**To generate tautomeric conformations of your compound:**

- Select the compound(s) in the molecular table. Selected compounds are highlighted in blue.
- Right click in the table and select the option Chemistry/ Enumerate Tautomers. Or select the Chemistry menu/Generate Tautomers.
- If you select Chemistry/Generate Tautomers a dialog box will be displayed. There is also an option to run in batch mode (click the **Files** Tab).
- Choose the table containing the compounds using the drop-down list.
- **Filter Unwanted Groups** option will filter results from patterns in the TAUTOFILTER.tab file provided in the distribution. If results match any row from that table then the it will be excluded.
- **Preserve Hybridisation** Although generally a change in hybridisation state will generate less stable compounds in some cases this is not the case and so you can choose to change hybridisation for a single atom.
- **Group Rows With Color** option will color tautomers from the same compound with the same color to visually highlight groups.
- The compounds will be displayed in a separate molecular table called TAUTOMERS.

How to generate tautomers.

NAME	molwt	version	molweight mol	mollogP mol	clogP
isomeric C7H8O2	128	chembridge 3140002 Reichardt F2044000	381.2	2.807	1
isomeric C20H20O2	300	561320 Reichardt F2054001	586.2	4.177	2
isomeric C20H20O2	300	4392	2.82	3	
isomeric C20H20O2	300	561320 Reichardt F2054010	381.2	2.808	4
isomeric C20H20O2	300	4342	2.82	5	
isomeric C20H20O2	300	561324 Reichardt F2054010	434.2	3.284	6

1. Chemistry/Generate Tautomers

2. Enter name of chemical table

Choose "Files" for batch mode

Generate Tautomers dialog box options:

- Use Tables:  Files
- Molecular Table: [mg\_database]
- Filter Unwanted Groups:
- Preserve Hybridisation:
- Group Rows With Color:

## 13.9 Generate Stereoisomers

### Theory

Isomers are molecules which have the same chemical formula and sometimes the same kind of bonds but in which the atoms are arranged differently.

Structural isomers have different atom-to-atom connections e.g. propanol (C<sub>3</sub>H<sub>8</sub>O or C<sub>3</sub>H<sub>7</sub>OH) has two isomers Propan-1-ol and Propan-2-ol.

Diastereomers are not mirror images and have different internal dimensions (e.g. dihedral angles and distances between non-bonded atoms). They can be configurational diastereomers (which can be interconverted only by breaking bonds or by changing the configurations of stereocenters) or conformational diastereomers (which can be interconverted by rotation about bonds – including chair flips or by lone pair inversion).

Enantiomers have identical internal dimensions, and are nonsuperimposable mirror images. Enantiomers can be configurational and conformational.

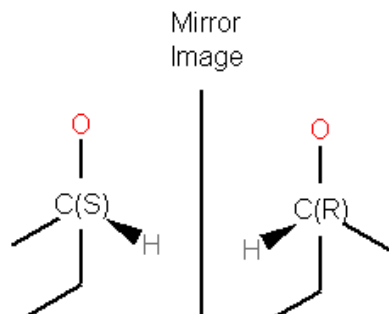

Enantiomers are distinguished based on the Latin terms for left (sinister) and right (rectus). In some cases where the handedness is unknown a chiral center can be labeled "RS" or unknown.

#### **To enumerate and display in a separate table the stereoisomers of selected compounds.**

- Select the compound(s) in the molecular table. Selected compounds are highlighted in blue.
- Right click in the table and select the option **Chemistry/ Enumerate stereoisomers**. Or select the Chemistry menu and choose **Generate Stereoisomers**. If you generate stereoisomers via the Chemistry menu you will get a dialog box whereby you can run the process in batch mode. There is also an option to color stereoisomers from the same compound with the same color.
- The compounds will be displayed in a separate molecular table called STEREOISOMERS.

*From the Chemistry Menu:*



**How to generate stereoisomers.**

**1. Chemistry/Generate Stereoisomers**

**Choose "Files" for batch mode**

**2. Enter name of chemical table**

mol	name	SMILES	mol	vendor	molWt/mol	molLogP/mol	mol	id
1		<chem>C1=CC=CC=C1</chem>		129 chembridge 3140002 Biochemica F3214-0008	94.07	2.85	1	1
2		<chem>C1=CC=C(C=C1)C2=CC=CC=C2</chem>		501.320 Biochemica F3254-0201	158.12	4.937	2	2
3		<chem>C1=CC=C(C=C1)C2=CC=CC=C2C3=CC=CC=C3</chem>		436.2	2.80	3	2	
4		<chem>C1=CC=C(C=C1)C2=CC=CC=C2C3=CC=CC=C3C4=CC=CC=C4</chem>		351.2	2.938	4	2	
5		<chem>C1=CC=C(C=C1)C2=CC=CC=C2C3=CC=CC=C3C4=CC=CC=C4C5=CC=CC=C5</chem>		474.2	2.97	5	3	
6		<chem>C1=CC=C(C=C1)C2=CC=CC=C2C3=CC=CC=C3C4=CC=CC=C4C5=CC=CC=C5C6=CC=CC=C6</chem>		591.324 Biochemica F3254-0103	434.2	3.288	6	4

```

lsm/det> delete hydrogen my_database.mol
lsm/det> modify my_database.mol auto
lsm/det> delete my_database.cluster(1)
lsm/det>
  
```

**From** a chemical spreadsheet: }

ricinLigands2D STEREOISOMERS

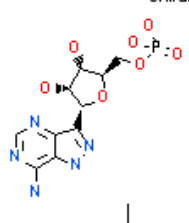
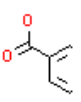
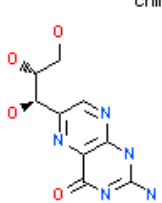
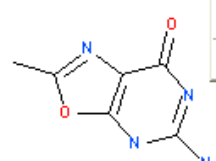
mol	NAME_
 <p>chiral</p>	<p>ricinLigands2D</p> <p>Edit Cells by Double-click</p> <p>Table View ▶</p> <p>Find in Table Ctrl+F</p> <p>Color By ▶</p> <p>Clustering... ▶</p> <p>Analysis ▶</p>
	<p>Select one or multiple compounds and right click on the drawing.</p> <p>Copy Molecule Image</p> <p>Copy Molecule Image To Album</p> <p>Save Molecule As EPS...</p> <p>Save Molecule As Image...</p>
 <p>chiral</p>	<p>Edit Molecule...</p> <p>Query Molecule</p> <p>Chemistry ▶</p> <p>Cell mol[1] ▶</p>
	<p>Copy Molecule Ctrl+C</p> <p>Paste Ctrl+V</p> <p>Print Table... Ctrl+P</p>

Results will be in the table entitled "STEREOISOMERS"

Enumerate Stereoisomers (current row)

Enumerate Tautomers (current row)

Remove Salt (current row)

Convert to 3D and Optimize

Load and Preserve Coordinates

Conformation Generator (selected rows)

Chemical Template Superposition (selected rows)

**NOTE:** Only centers with unknown chirality will be enumerated.

## 13.10 Cluster Set

Clustering is described in more detail in the [Tables Clustering](#) section of this manual. To undertake chemical clustering choose:

- Chemistry/Cluster Set

### 13.10.1 How to perform chemical clustering.

How to perform chemical clustering.

1. Click on the "Run Clustering" button

```

lsm/de> make tree my_database full "OPERA" split="cl" label="SHARE_" name=""
Info: Column 'ord' (record number in the tree order) has been appended to table my_database.
Info: Column 'cl' (cluster number) has been appended to table my_database.
Info: Tree 'my_database.cluster[1]' has been successfully created.
lsm/de> sort my_database.ord
lsm/de>

```

### 13.10.2 How to select representative centers from a tree.

How to select representative centers from a tree.

Right click in white space for all centers or on a node for centers of a branch

```

lsm/de> make tree my_database full "OPERA" split="cl" label="SHARE_" name=""
Info: Column 'ord' (record number in the tree order) has been appended to table my_database.
Info: Column 'cl' (cluster number) has been appended to table my_database.
Info: Tree 'my_database.cluster[1]' has been successfully created.
lsm/de> sort my_database.ord
lsm/de>

```

### 13.10.3 How to reorder branches and change the distance of trees.

How to re-order branches and change distance of tree.

To change distance – click and drag here

To re-order branches – right click in white space

my\_database Molsoft Chem3D 3.6.1g [NewProject] (1 table)

id	name	mol	vendor
1	name=C2H4O2N2	129 chembridge 914092	Bechemicals F204-009
2	name=C2H4O2N2	561323	Bechemicals F204-016
3	name=C2H4O2N2	561330	Bechemicals F204-016
4	name=C2H4O2N2	561330	Bechemicals F204-016
5	name=C2H4O2N2O4	561322	Bechemicals F204-016
6	name=C2H4O2N2O2	561324	Bechemicals F204-013

no selection  
tables (1 item)  
-my\_database - 10001 rows 6 cols 1 heads

Info: Column 'mol' (record number in the tree order) has been appended to table my\_database.  
Info: Column 'cl' (cluster number) has been appended to table my\_database  
Info: Tree 'my\_database-cluster(1)' has been successfully created  
cmd/de> sort my\_database.cmd  
cmd/de>

### 13.10.4 How to edit the tree – labels, spacing and coloring.

How to edit the tree – labels, spacing and coloring.

To edit labels, spacing and coloring: right click on the tree

To change record labels: right click in white space and select "Change Record Labels"

my\_database Molsoft Chem3D 3.6.1g [NewProject] (1 table)

id	name	mol	vendor
1	name=C2H4O2N2	129 chembridge 914092	Bechemicals F204-009
2	name=C2H4O2N2	561323	Bechemicals F204-020
3	name=C2H4O2N2	561323	Bechemicals F204-020
4	name=C2H4O2N2	561330	Bechemicals F204-016
5	name=C2H4O2N2O4	561322	Bechemicals F204-016
6	name=C2H4O2N2O2	561324	Bechemicals F204-013

no selection  
tables (1 item)  
-my\_database - 10001 rows 6 cols 1 heads

Info: Column 'mol' (record number in the tree order) has been appended to table my\_database.  
Info: Column 'cl' (cluster number) has been appended to table my\_database  
Info: Tree 'my\_database-cluster(1)' has been successfully created  
cmd/de> sort my\_database.cmd  
cmd/de>

## 13.11 PCA Analysis

PCA analysis is described in the tables section [here](#).

## 13.12 Compare Two Sets

*To compare two chemical tables for similar compounds:*

- Read the two tables into ICM.
- **Chemistry/Compare Two Sets...**
- Select the first table from the drop-down list and then select the second table.
- Choose whether you want to use **exact** or **similarity** comparison. If the **similarity** option is selected a **Distance** value needs to be entered.
- Select OK
- Similar compounds will be highlighted blue (selected). A selection can be transferred to a new table by right-clicking on the table and select **Copy Selection to ICM Table**.

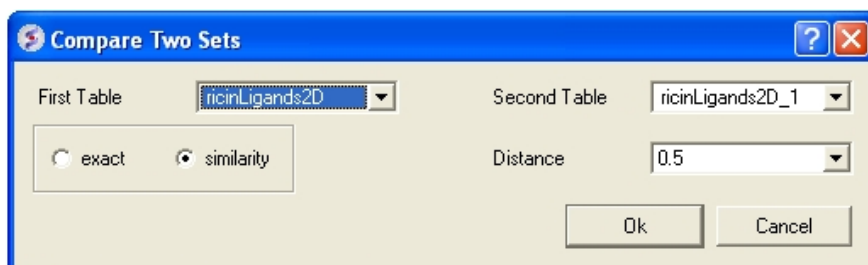

## 13.13 Merge Two Sets

*To merge two tables:*

- Read the two tables into ICM.
- **Chemistry/Merge Two Sets**
- Select the first table from the drop down list (Table A) and the column you wish to use to merge the table by.
- Select merge method 1. **inner** – only molecules present in BOTH A and B tables are kept; or 2. **left** ALL rows of A are kept ; or 3. **right** ALL rows of B are kept.
- Select the second table from the drop down list (Table B) and the column you wish to use to merge the table by.
- Enter a name for the output table.
- Click OK and a new table will be displayed.

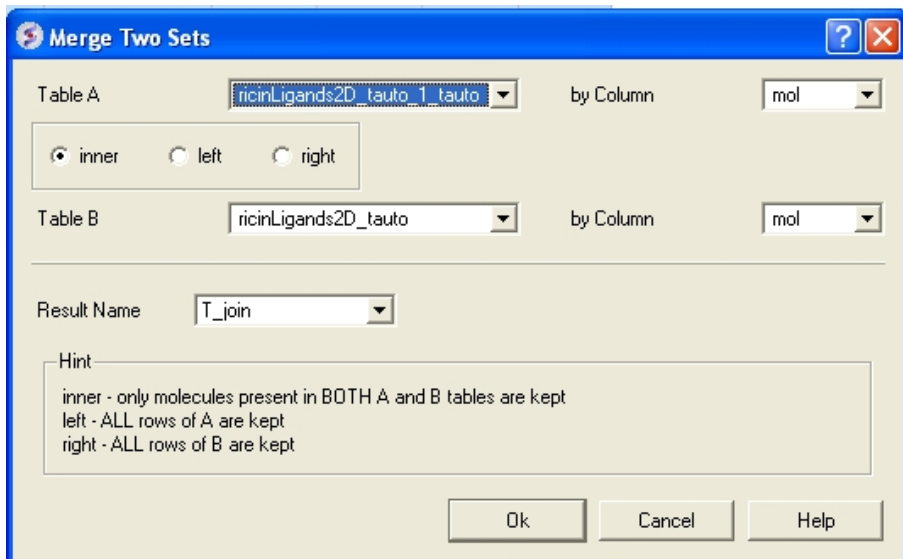

## 13.14 Select Duplicates

**NOTE:** Gui option is available in versions 3.5–1o and higher. The command line options for this function are described in the ICM Command Language manual at <http://www.molsoft.com/man/icm-functions.html#Index-chemical>

This option allows you to select and remove duplicate chemicals in a table.

- Read a chemical table into ICM.
- Chemistry/Select Duplicates
- Enter the table name you want to check for duplicates
- Enter whether you want chirality or the salts included in the analysis.
- Press OK
- Duplicate compounds will be **highlighted** blue in the table. You can delete them by right clicking on the row header and selecting **Delete Rows(s)**



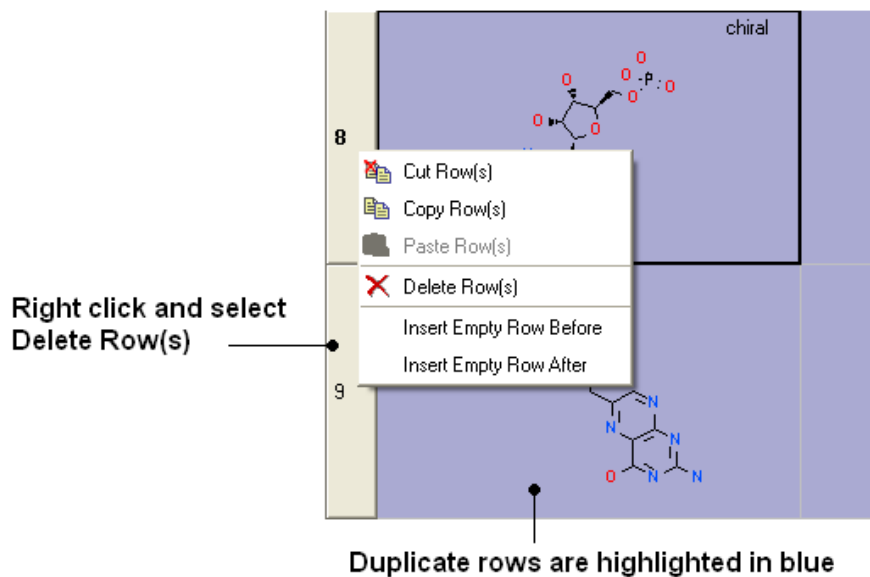

## 13.15 Combinatorial Chemistry

### 13.15.1 Create/Modify Markush

*To create or modify a Markush Structure:*

- Use the Molecular Editor to edit the scaffold as shown below.

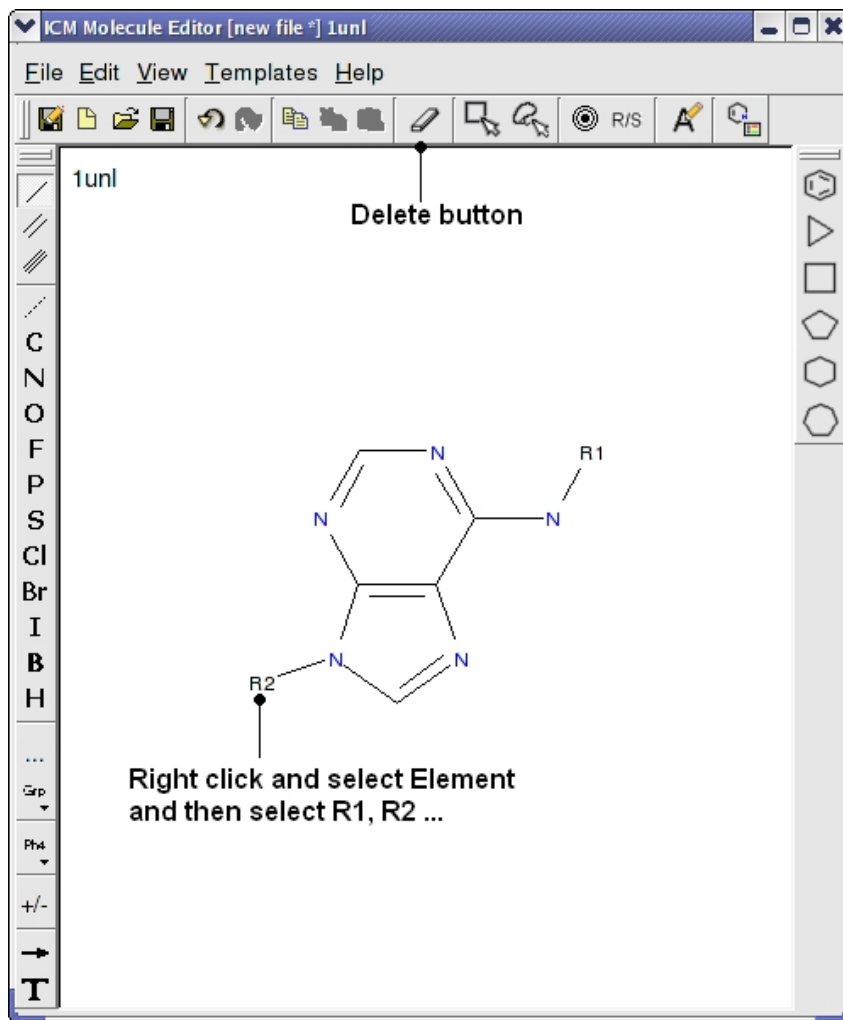

- Close the Molecular Editor window by clicking on the cross in the top right hand corner and the changes will be submitted to the table.
- The sketch in the chemical spreadsheet is named "chem" by default. For this example we will rename it "scaffold". You can rename it by right clicking on the table tab and selecting rename.

#### Step 4: Create Markush Combinatorial Library

- Read in a table of substituents. For this example we will use an sdf file called combiDock\_R1.sdf – this can be found in the ICM distribution (File/Open). If you cannot find this file please E mail support@molsoft.com and we will send it to you.
- Chemistry/Create Modify Markush and enter the data as shown below and press next.

Create/Modify Markush

Scaffold Or Markush  Index

Result Name

Next Cancel

- Enter the name of the table containing substituents for R1 and R2. In this example we will use the same table **combiDock\_R1** for R1 and R2 as shown below. You can use the drop down arrows to select the table you require.



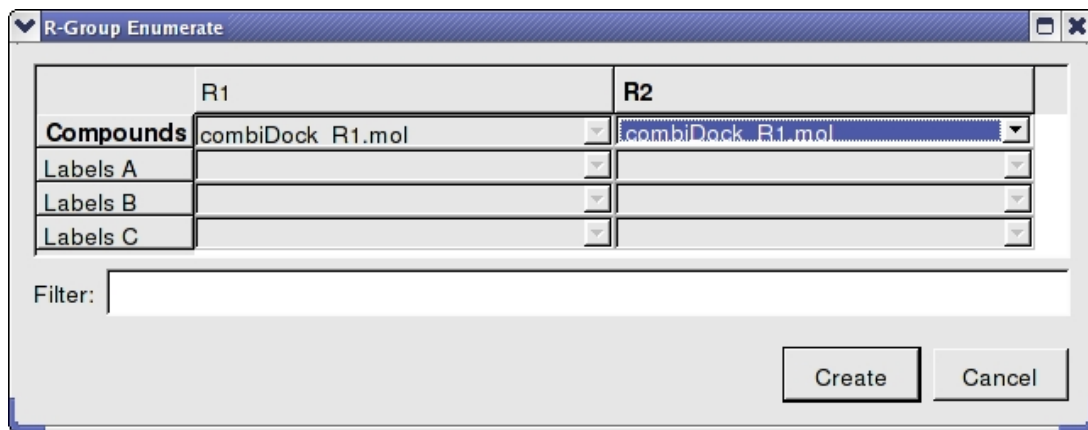

- Once the tables are selected press **Create** and a new chemical table will be displayed with the markush structure annotated with the substituents for R1 and R2 as shown below.

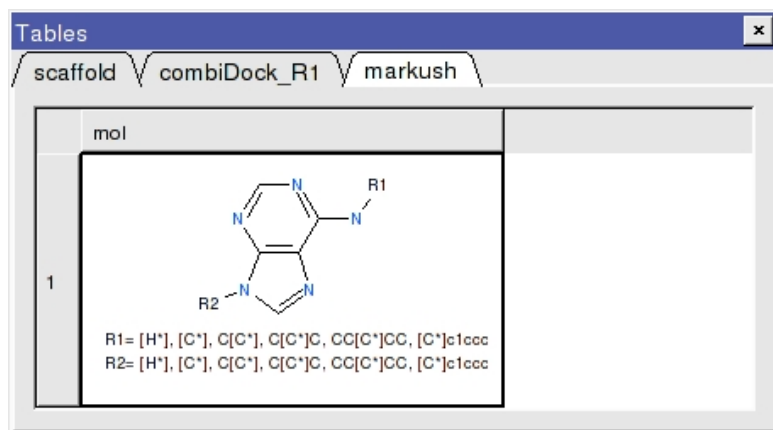

### 13.15.2 How to create a Markush structure.

### How to create a Markush structure. (1)

1. Sketch a Markush structure in the molecule editor and save it as a chemical spreadsheet

Remember to add R-groups to your scaffold.

### How to create a Markush structure. (2)

Read in a set of chemical substituents for each of your R-groups in your Markush scaffold

ICM comes with some built in substituents if you want to use those.

### How to create a Markush structure. (3)

**1. Chemistry/Create/Modify Markush**

**2. Enter the name of the table and the row number containing your Markush structure (scaffold)**

Info: table markush (0 headers, 1 rgroup) has been created  
 Headers:  
 Access: 1 markush.mol  
 low/de? delete markush0name  
 low/de? delete markush  
 low/de? :

### How to create a Markush structure. (4)

**1. Enter the table names for each R-group**

**2. Click "Create"**

```
low/de? delete markush0name
low/de? delete markush
low/de? molid = molFold.mol( 1 )
low/de? markush0name = Show( "markush" unique )
low/de? _out2 = Ahq( molid, enumerate link )
```

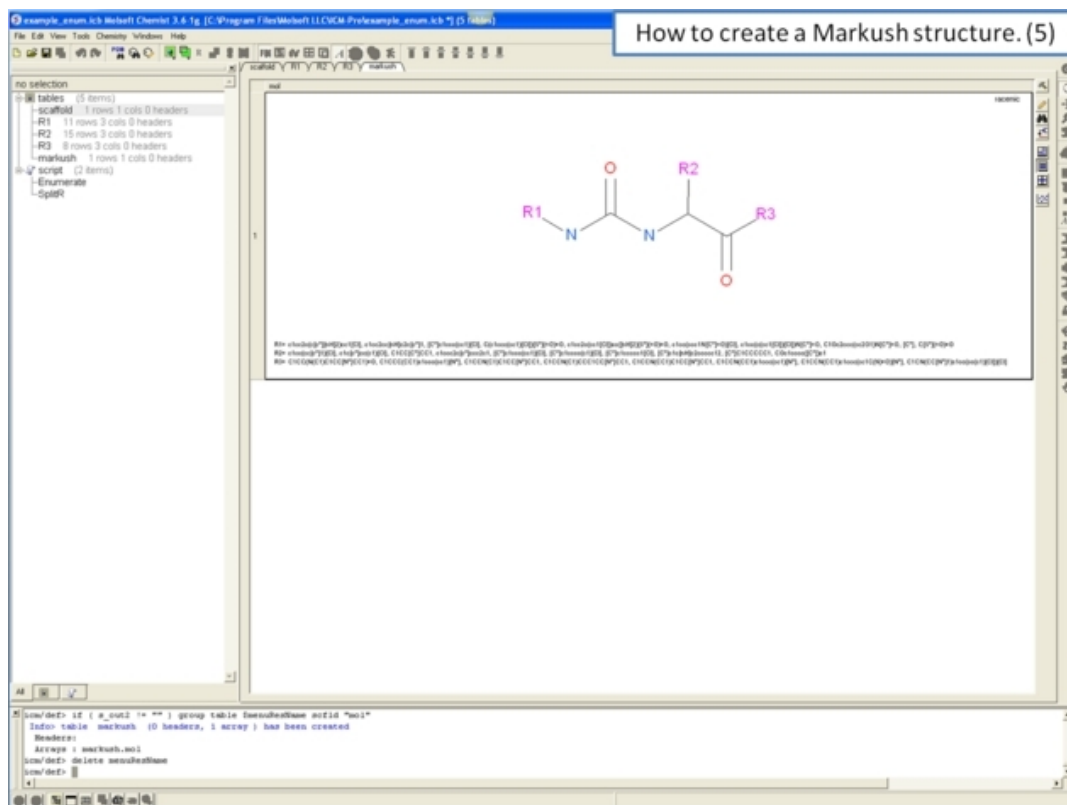

### 13.15.3 Enumerate by Scaffold

To enumerate a library based on R-groups you first need to draw a sketch of the structure and display it in a chemical spreadsheet. To do this:

- Open up the ICM Molecular Editor.
- Draw the template structure with R-groups attached. Right click on an atom and select Element/R1, R2 ...

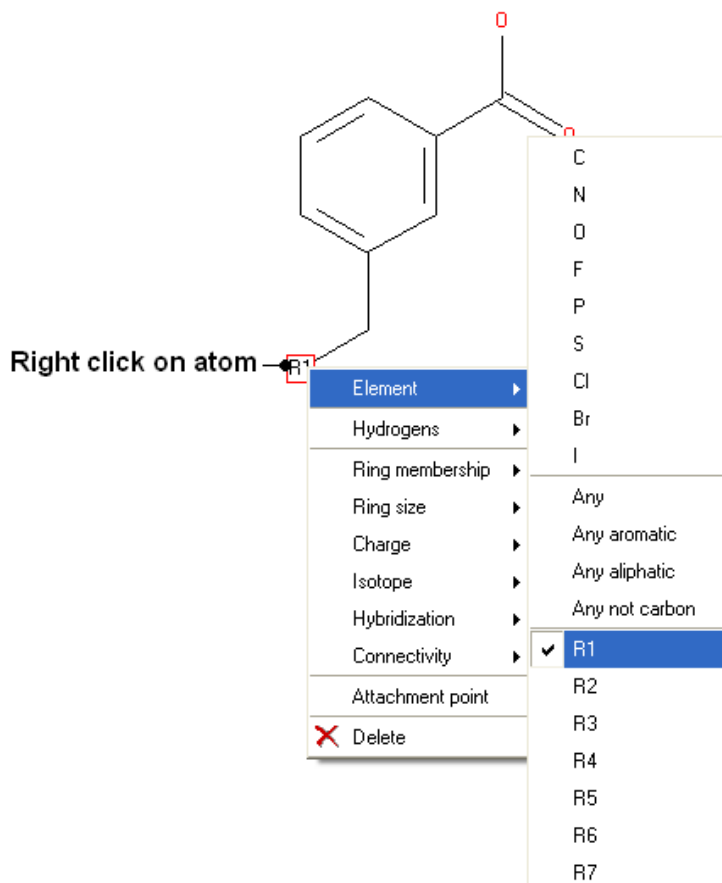

- In the Molecular Editor select File/Append to Table/New

The next step is to read into ICM or construct a table of substituents. You can read in an SDF, mol, smiles file or `extract fragments`. If you do not want the first atom of the substituents to be the attachment point you need to define the attachment point. Attachment points are automatically assigned when you `extract fragments` or you can define them manually by:

- Right click on the substituent sketch and select **Edit Molecule**
- Right click on the atom and select **Attachment point**.

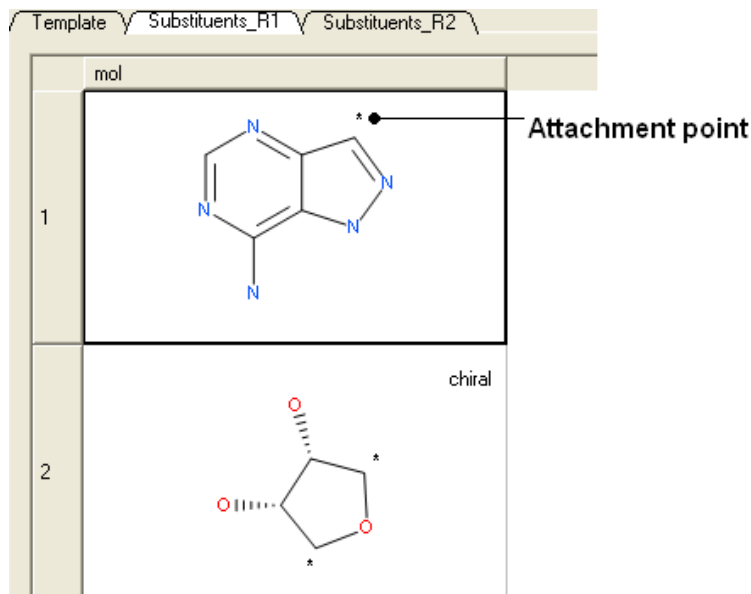

## Next enumerate the library

- Select the template structure (highlighted blue).
- Right click on the structure and select Chemistry/Enumerate R-groups or use the Chemistry menu and select Enumerate by Markush. If you use the menu option you will need to choose the table containing the scaffold from the drop down list of currently loaded tables. The index number refers to the row number in the scaffold table. In this example we only have one row containing the scaffold so the index number is 1.
- Select the R1, R2... table , labels and filters if necessary.

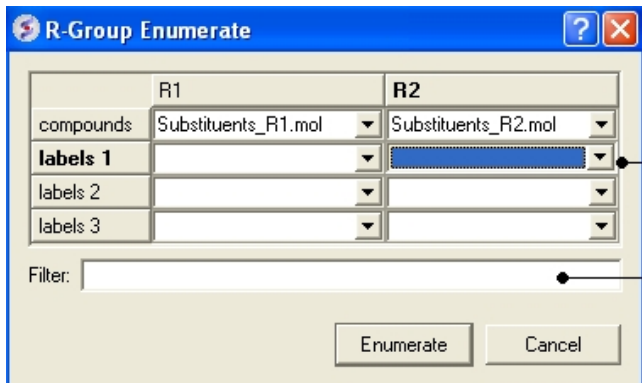

Bring over important labels into enumerated library eg compound ID number

Type condition here:  
eg R1 != R2  
MolWeight < 500

A new table will be produced called **T\_enum** with the Template structure highlighted in red.

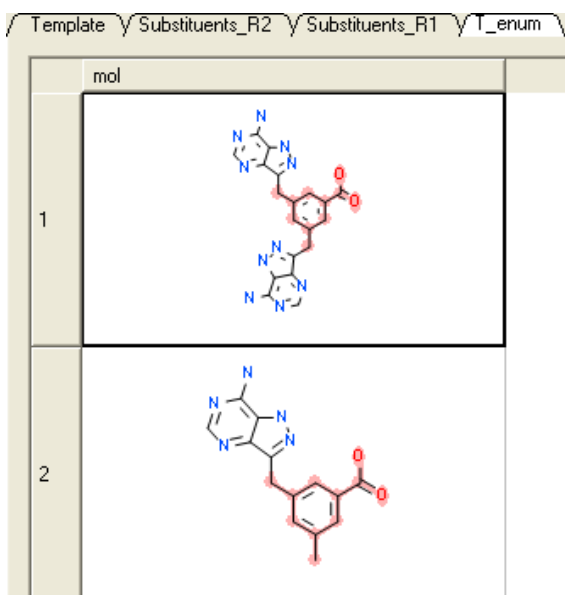

## 13.15.4 How to enumerate a Markush library.

### How to enumerate a Markush chemical library. (1)

1. Sketch a Markush structure in the molecule editor and save it as a chemical spreadsheet

Remember to add R-groups to your scaffold.

no selection  
 tables (4 items)  
 -scaffold 1 rows 3 cols 0 headers  
 -R1 11 rows 3 cols 0 headers  
 -R2 15 rows 3 cols 0 headers  
 -R3 8 rows 3 cols 0 headers  
 script (2 items)  
 -Enumerate  
 -Split

Info: 1 table written to file V:\training course\icm-chemlist-webinar-1209\R1.mst  
 low/def> write table mol compress R2 "V:\training course\icm-chemlist-webinar-1209\R2.mst"  
 Info: 1 table written to file V:\training course\icm-chemlist-webinar-1209\R2.mst  
 low/def> write table mol compress R3 "V:\training course\icm-chemlist-webinar-1209\R3.mst"  
 Info: 1 table written to file V:\training course\icm-chemlist-webinar-1209\R3.mst  
 low/def> |

table 1 row, 1 column

### How to enumerate a Markush chemical library. (2)

Read in a set of chemical substituents for each of your R-groups in your Markush scaffold

ICM comes with some built in substituents if you want to use those.

no selection  
 tables (4 items)  
 -scaffold 1 rows 3 cols 0 headers  
 -R1 11 rows 3 cols 0 headers  
 -R2 15 rows 3 cols 0 headers  
 -R3 8 rows 3 cols 0 headers  
 script (2 items)  
 -Enumerate  
 -Split

	R1 ID	R2 ID	R3 ID
1	G1	E01	
2		E02	
3		E03	
4		E04	E04
5		E05	E05
6		E06	E06

Info: 1 table written to file V:\training course\icm-chemlist-webinar-1209\R1.mst  
 low/def> write table mol compress R2 "V:\training course\icm-chemlist-webinar-1209\R2.mst"  
 Info: 1 table written to file V:\training course\icm-chemlist-webinar-1209\R2.mst  
 low/def> write table mol compress R3 "V:\training course\icm-chemlist-webinar-1209\R3.mst"  
 Info: 1 table written to file V:\training course\icm-chemlist-webinar-1209\R3.mst  
 low/def> |

How to enumerate a Markush chemical library. (3)

1. Chemistry/Enumerate by Scaffold

2. Enter the name of the table and the row number containing your Markush structure (scaffold)

```

Info: 1 table written to file V:\training course\low-chemsit-web\low-1209\31_05F
low/de> write table mol compress R2 "R1/training course/low-chemsit-web\low-1209\32_05F"
Info: 1 table written to file V:\training course\low-chemsit-web\low-1209\32_05F
low/de> write table mol compress R3 "R1/training course/low-chemsit-web\low-1209\33_05F"
Info: 1 table written to file V:\training course\low-chemsit-web\low-1209\33_05F
low/de>
  
```

How to enumerate a Markush chemical library. (4)

1. Enter the table names for each R-group

2. Click "Enumerate" and a new table of compounds will be displayed called "enum\_result"

```

low/de> molid = molE010.mol[ 1 ]
low/de> a_mol2 = Anq[ molid, enumerate ]
low/de> IE ( a_mol2 [ = = ] ) enumerate library molid E_a_mol2 name = Name( "enum_result" unique )
low/de> molid = molE010.mol[ 1 ]
low/de> a_mol2 = Anq[ molid, enumerate ]
  
```

### 13.15.5 R-Group Decomposition

To decompose a library into fragments based on a Markush scaffold (opposite of R-group (Markush) enumeration):



- Read the sdf file you wish to decompose into ICM and it will be displayed as a molecular table.
- **Chemistry/R-Group Decomposition** and a window as shown below will be displayed.
- You now have two options on how to define the Markush scaffold. You can either 1). Draw it using the molecular editor and the smiles string will be added to the window shown below or 2). select a row of a preexisting table.

The image illustrates two methods for defining a Markush scaffold in the R-Group Decomposition dialog box. On the left, a table window shows a benzene ring scaffold in row 1, with an arrow pointing to the 'Choose Table With Scaffold' option in the dialog box. On the right, a molecular editor window shows a benzene ring scaffold, with an arrow pointing to the 'Draw New Scaffold' option in the dialog box, which also displays the SMILES string c1ccc(cc1)[R1].

- Use the drop-down option to select the table you wish to decompose.
- If you have more than one R-group ICM can either generate a different table for each R-group or it can merge it into one single table whereby column will represent R1 and column two R2 .... This option is useful if you want to generate a SAR table with a column of activity data next to the R1 and R2 columns (see below).
- If you check the box "Auto Add Missing R Groups" then unique R-groups will be extracted from the scaffold where hydrogens can be attached.

### Single SAR table

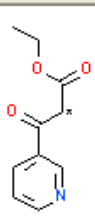
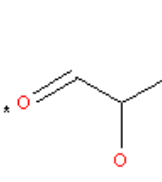
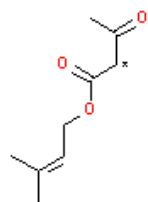
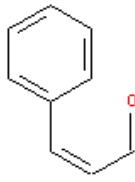
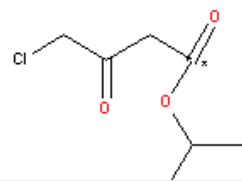
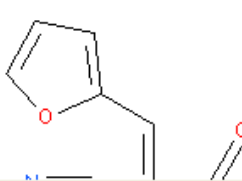
reactant1	reactant2	markush	enum_result	T_sar
67				racemic 78
68				77
69				77

### 13.15.6 How to decompose a library based on a Markush structure.

How to decompose a library based on a Markush structure. (1)

1. Sketch a Markush structure in the molecule editor and save it as a chemical spreadsheet

2. Read in the table you wish to decompose

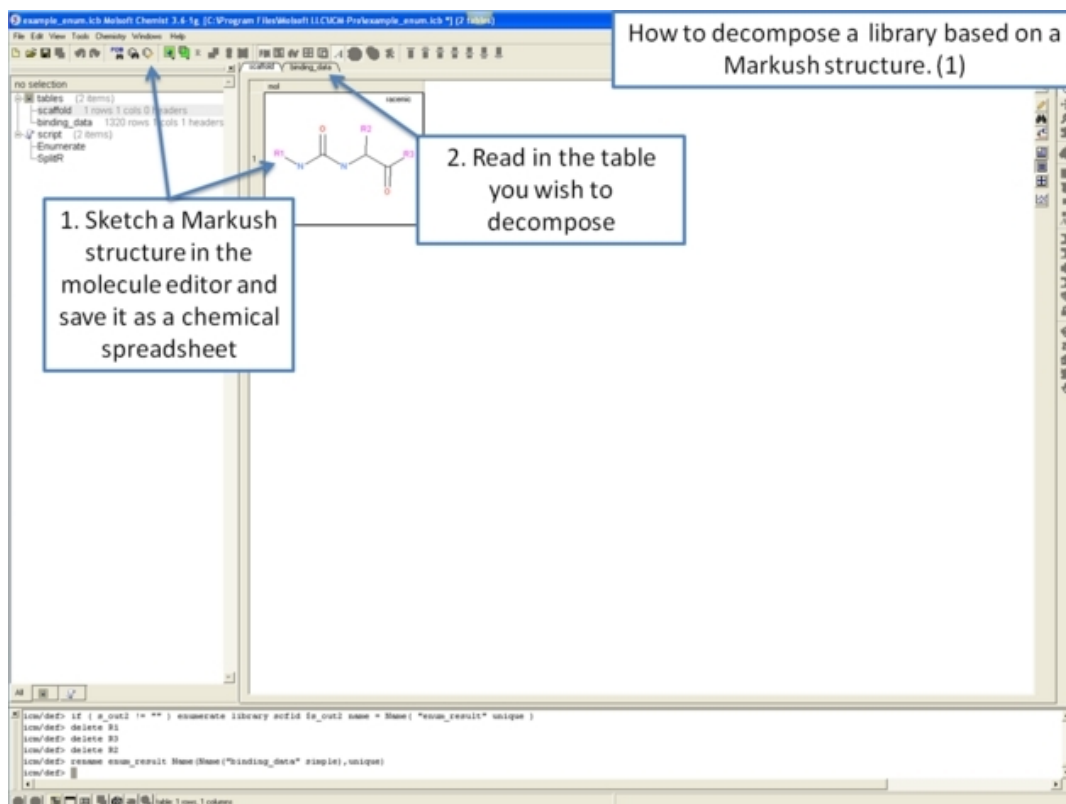

```

row/def> if ( n_out2 != "" ) enumerate library scaffold is_out2 name = Show("enum_result" unique)
row/def> delete R1
row/def> delete R2
row/def> delete R3
row/def> readenum enum_result Show(Show("binding_data" unique), unique)
row/def>
table 1 row, 1 column
  
```

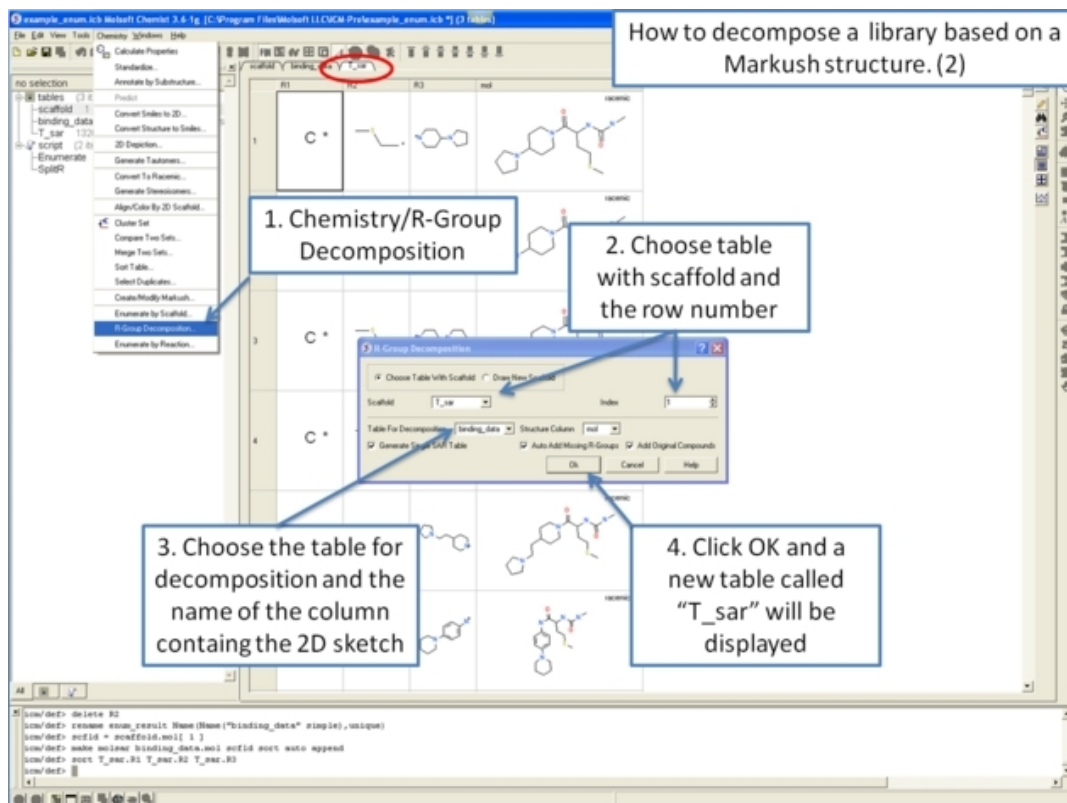

### 13.15.7 Enumerate by Reaction

Reactions can be drawn using the ICM Molecular Editor. Reactants should be drawn side-by-side (no + sign is necessary) and separated from the product using the arrow. See example shown below:

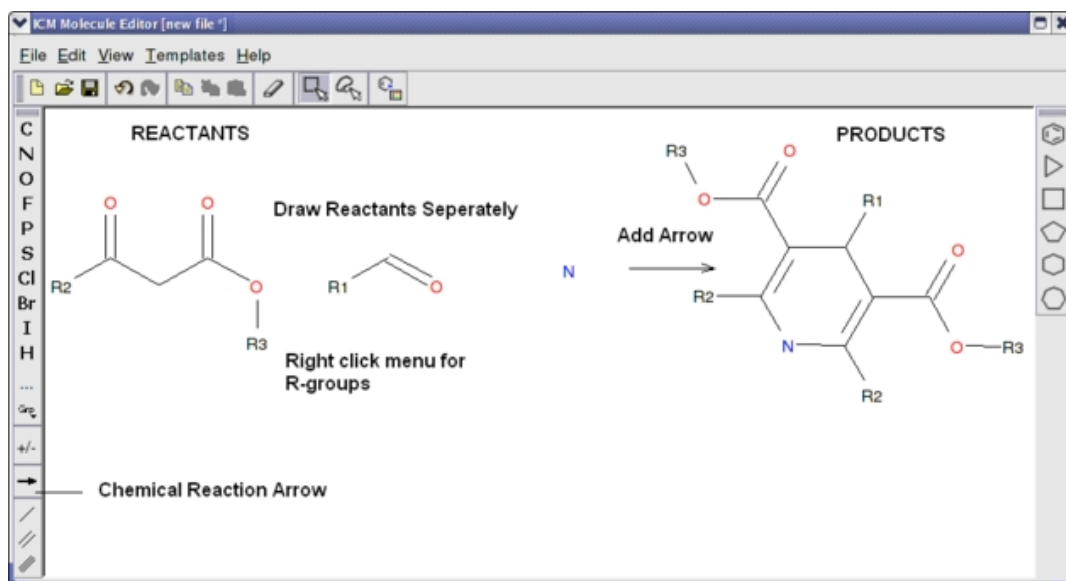



This example is available in the ICM distribution as example\_reaction1.icb. The reaction is the Hantzsch Dihydropyridine (Pyridine) Synthesis. This reaction allows the preparation of dihydropyridine derivatives by condensation of an aldehyde with two equivalents of a  $\alpha$ -ketoester in the presence of ammonia. Subsequent oxidation (or dehydrogenation) gives pyridine-3,5-dicarboxylates, which may also be decarboxylated to yield the corresponding pyridines.

In this example we have two reactants therefore it is necessary to have two reactant substructure tables loaded into ICM. ICM will match the substructure drawn in the reaction with the chemicals in thereactant

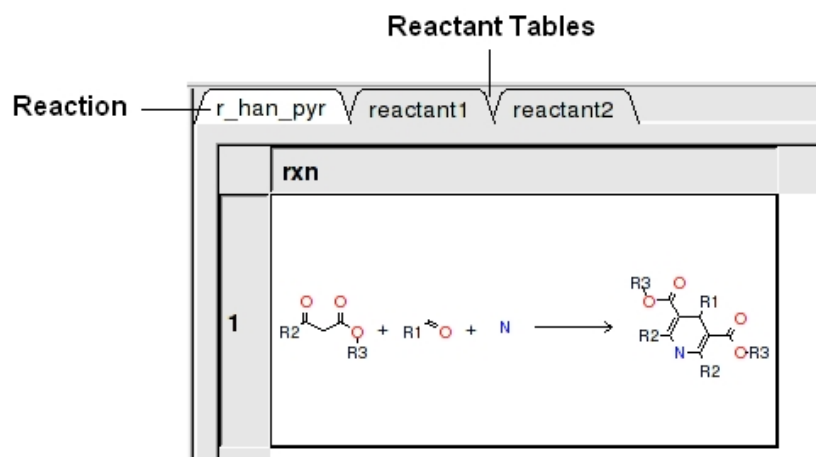
table.

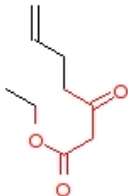
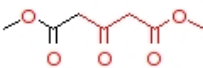

reactant 1 table:

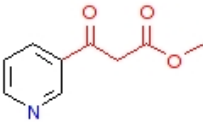
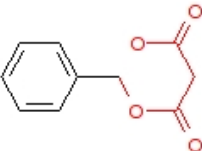
r_han_pyr	reactant1	reactant2	Substructure search: Found <b>88</b> hits of 'O=C([C;D2]C(=O)O[R3])[	
	molid	MolW	mol	vendors
18	65236	170.094		asdi:500028335
19	87804	174.053		apolloscientific:12582 asdi:500014701
20	65360	182.058		apolloscientific:13718 keyorganics:11X-0925
21	87822	179.058		apolloscientific:2965 interchim:616
22	3341	194.058		asdi:500016383

**To apply a reaction:**

- Chemistry/Enumerate by Reaction.
- In this example (example\_reaction1.icb) we already have the reaction drawn in a chemical table. Therefore select the **Choose Table With Reaction**. If you would like to draw a new reaction select **Draw New Reaction**.
- Enter the name of the table containing the reaction. If you have more than one reaction drawn you can select the row using the index option.
- Click OK and then you will be asked to enter the Reactants. Select the reactant tables from the drop down arrow for Reactant 1 and Reactant 2.
- You can transfer information to the reactant table by selecting columns in the **Labels** section.
- Unused reactants can be marked.
- Select what you want to do with multiple matches.

A table of Products will be then displayed in a table called T\_out. Columns in T\_out labeled "rct" display which reactants were used to build the product.

Table of Products

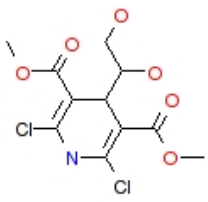
r_han_pyr	reactant1	reactant2	T_out
	mol	rct1	rct2
1		1	1

Numbers indicate which reactant was used for the product

### 13.15.8 How to enumerate a chemical library by reaction.

How to enumerate a chemical library by reaction. (2)

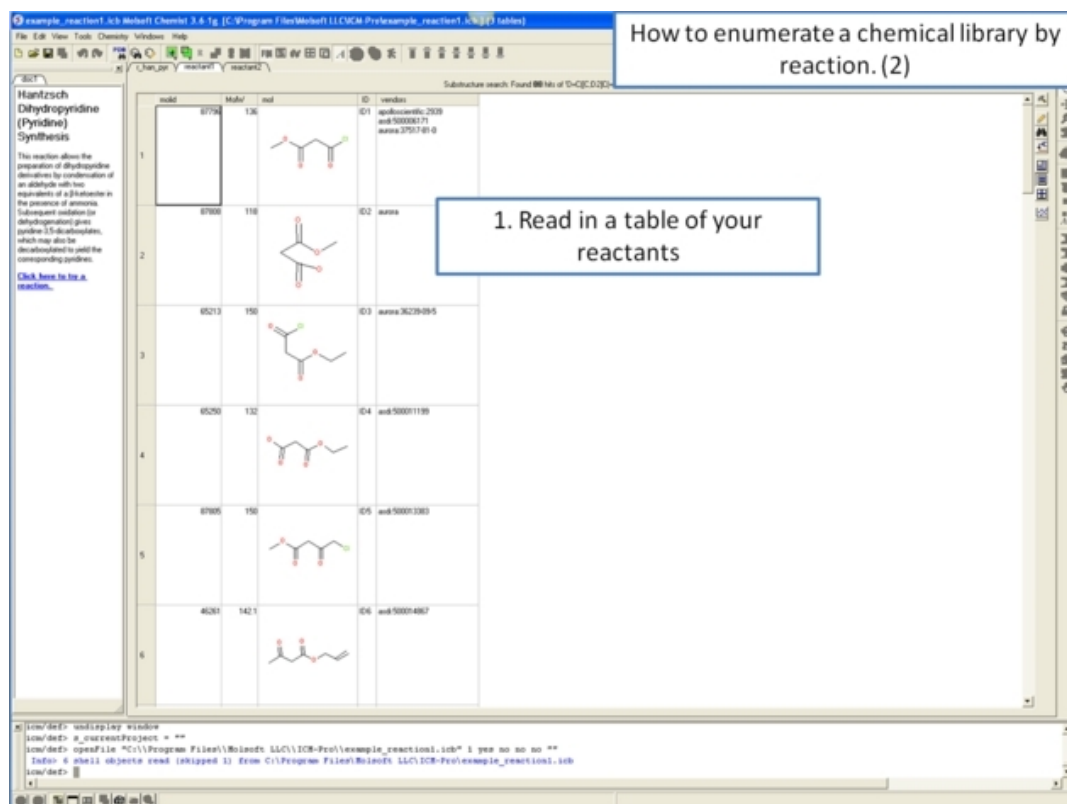

The screenshot shows a software window titled "example\_react1.icb" with a table of reactants. The table has columns for "mol", "rct1", and "rct2". The first row is highlighted, and a callout box points to it with the text "1. Read in a table of your reactants".

mol	rct1	rct2
8756	136	
8760	138	
85213	156	
8526	132	
8765	158	
4261	1421	

```

c:\m\de> undisplay window
c:\m\de> _currentProject = **
c:\m\de> openFile "C:\Program Files\Biosoft LLC\ICB-Pro\example_reactions.icb" 1 yes no no **
Table: 6 shell objects read (skipped 1) from C:\Program Files\Biosoft LLC\ICB-Pro\example_reactions.icb
c:\m\de>
  
```

example\_reacton1.icb Molsoft Chem3D 3.6.1g [C:\Program Files\Molsoft\LLCGM-Pro\example\_reacton1.icb] (table)

How to enumerate a chemical library by reaction. (1)

1. Sketch reactants and products in the molecule editor

```

c:\m\de> volscipy window
c:\m\de> _m_currentProject = **
c:\m\de> openFile "C:\Program Files\Molsoft\LLCGM-Pro\example_reacton1.icb" 1 yes no no **
Info: 6 shell objects read (skipped 1) from C:\Program Files\Molsoft\LLCGM-Pro\example_reacton1.icb
c:\m\de>

```

example\_reacton1.icb Molsoft Chem3D 3.6.1g [C:\Program Files\Molsoft\LLCGM-Pro\example\_reacton1.icb] (table)

How to enumerate a chemical library by reaction. (3)

1. Chemistry/Enumerate by Reaction

2. Enter the name of the table and the row number containing your reaction sketch (Reaction)

```

c:\m\de> volscipy window
c:\m\de> _m_currentProject = **
c:\m\de> openFile "C:\Program Files\Molsoft\LLCGM-Pro\example_reacton1.icb" 1 yes no no **
Info: 4 shell objects read (skipped 1) from C:\Program Files\Molsoft\LLCGM-Pro\example_reacton1.icb
c:\m\de>

```

## How to enumerate a chemical library by reaction. (4)

1. Enter the names of the tables with your reactants and a new table called "react\_results" will be displayed with your new library

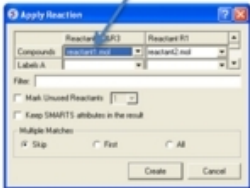

```
cmd/dec> openFile "C:\Program Files\Bioinformatics\CCDC\Pro\example_reactions.tbl" 1 yes no no ""
Info: 4 shell objects read (skipped 1) from C:\Program Files\Bioinformatics\CCDC\Pro\example_reactions.tbl
cmd/dec> molId = c_hm_gyr.cxn[ 1 ]
cmd/dec> e_mol2 = Anqi molId, enumerate ;
```







# 14 Working with Tables

**Note:** Click **Next** (top right hand corner) to navigate through this chapter. Headings are listed on the left hand side (web version) or by clicking the **Contents** button on the left-hand-side of the help window in the graphical user interface.

One of the easiest ways to store, sort and display data in ICM is by the use of a table. In most cases tables are automatically created, for example, if you search for a PDB file or when you load a compound database (SDF file). It is also possible for you to create your own table. Once a table is created, ICM provides easy to use tools to sort, add, edit and plot data.

Here we will concentrate on describing the actions you can perform on a table once it has been read into ICM. We will start by describing a simple table. Actions which can be performed on chemical/molecular tables are described in the section entitled Working with Chemical Spreadsheets.

A standard ICM table:

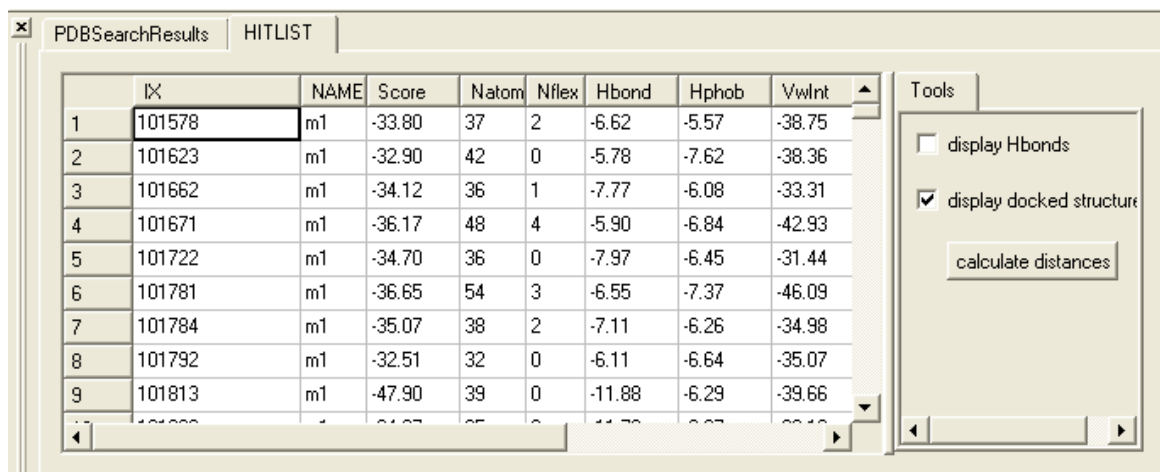

The screenshot shows a window titled 'PDBSearchResults' with a sub-tab 'HITLIST'. It contains a table with the following data:

	ID	NAME	Score	Natom	Nflex	Hbond	Hphob	VwInt
1	101578	m1	-33.80	37	2	-6.62	-5.57	-38.75
2	101623	m1	-32.90	42	0	-5.78	-7.62	-38.36
3	101662	m1	-34.12	36	1	-7.77	-6.08	-33.31
4	101671	m1	-36.17	48	4	-5.90	-6.84	-42.93
5	101722	m1	-34.70	36	0	-7.97	-6.45	-31.44
6	101781	m1	-36.65	54	3	-6.55	-7.37	-46.09
7	101784	m1	-35.07	38	2	-7.11	-6.26	-34.98
8	101792	m1	-32.51	32	0	-6.11	-6.64	-35.07
9	101813	m1	-47.90	39	0	-11.88	-6.29	-39.66

To the right of the table is a 'Tools' panel with the following options:

- display Hbonds
- display docked structure
- calculate distances

## 14.1 Standard ICM Tables

### 14.1.1 Generate New Table

*To generate a new empty table:*

- File/New and select the **Table** tab and a window as shown below will be displayed.
- Enter the number of rows and columns you wish to include in your table and whether you wish to add a column with chemical data.
- If you wish to make a chemical table (chemical spreadsheet) select the **Chemical Column** box.

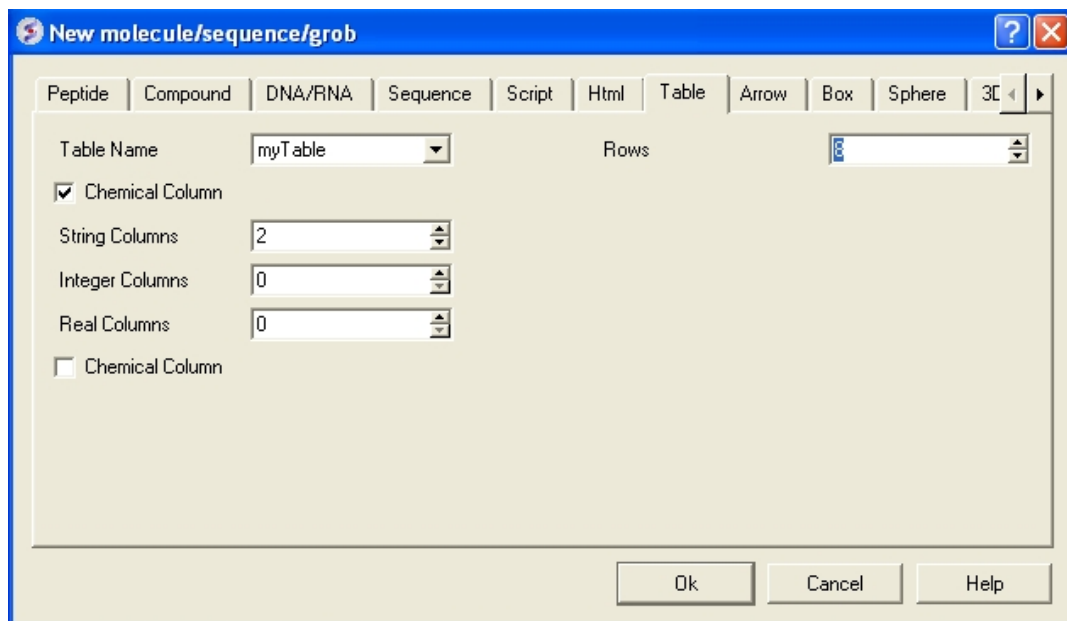

## 14.1.2 Reading a Table

A table can be read and saved as a .csv file or a .tab file. Saving or reading your table as a csv (comma separated value) file enables the table to be transferred or loaded from other applications such as Microsoft Excel. A compound database such as an .sdf file can also be viewed as a table in ICM, additional details on how to manipulate a molecular table is explained in the next section.

*A table can be read into ICM by selecting:*

- File/Open and then selecting the table you have saved.

OR

Sometimes data is naturally stored and displayed in a table – e.g. PDB data. A common use of tables is for compound data. An explanation of how to use compound molecular tables is in the next section entitled ICM Molecular Tables.

*For an example of a table try the following:*

- Select PDB search tab.
- Type \* into data entry box.
- Click on the button next to the data entry box.

A table of all the PDB structures will be displayed at the bottom of the GUI.

**NOTE:** If you have loaded a table and it is not displayed it may be because the table window is hidden. To display the table, select the window menu and select table see the Window Menu Section.

## 14.1.3 Saving a table

*To save the whole table:*

- To save a table right click on the table header tab and select Save As..

*To save a row selection:*

- Select a row(s)
- Right click and choose **Save Selection As** or **Save Selection As Csv + Headers**

## 14.1.4 Basic Table Navigation

To view the contents of a table you can move the table up and down using the scroll bars on the side and bottom of the display.

**NOTE:** If you have loaded a table and it isn't displayed it may be because the table display isn't selected. To select the table display, select the window menu and select table (See Window Menu Section).

If you have read more than one table in ICM you can select a table by clicking the tab on the top of the table (See Below).

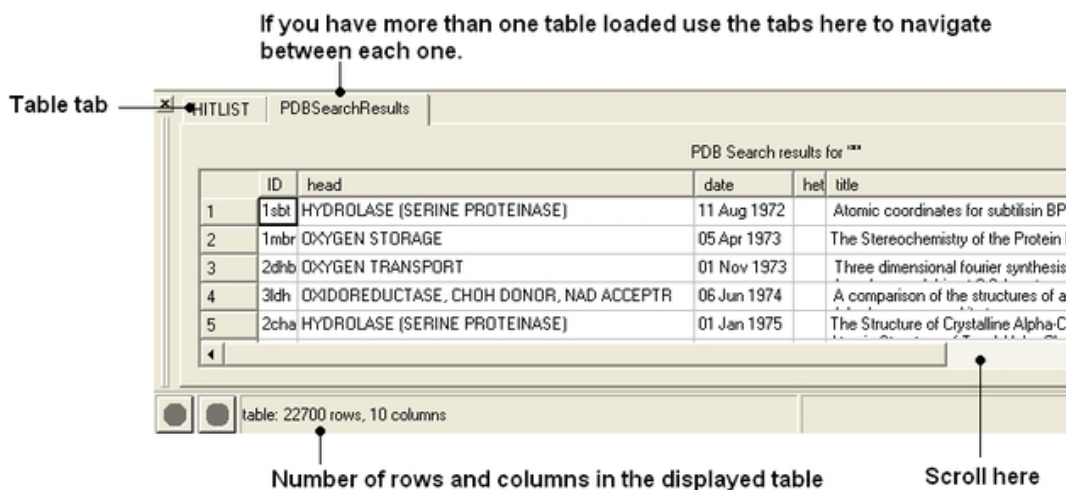

**NOTE:** Double clicking on the tab allows two tables to be displayed at once. Double clicking again returns to the default table layout.

**NOTE:** Information regarding the number of rows and columns within a table is displayed at the bottom of the table.

*If you would like the table to be the main window in the graphical user interface:*

- Select Windows/Table→Main

## 14.1.5 Table View (Grid Layout)

*To change the table view (layout):*

- Select the columns you wish to display in grid view. No selection will place all columns in grid view
- Right click on a table row and select **Table View**
- You can view the table in **Grid View** and toggle between grid and standard view. You can define your own grid using the **Custom Grid** option or display the table in **Form View**.

**NOTE:** You can save a table view.

## 14.1.6 Table View Save

Once you have a table view that you want to keep. You can save it by:

- Right click on a table row and select **Store Views**
- Select **Save Current View**

- Enter a name for the table view and you can return to that view by repeating the first two steps above.
- You can rename, delete or restore view by right clicking on the name of the table view.

## 14.1.7 Table Search

*To search a table:*

- Right click on a table row and select **Find and Replace**. You can also use CTRL F.
- Enter a search string.
- Press the **Find** button.

## 14.1.8 Table Color

*You can color your table based on values within a column by:*

- Right click on the column header and select **Format**.
- In the **Background** panel select the color you desire eg **Single Color** or you can by a rainbow according to the data in the column. To edit the range of values relating to each color click on the pencil (edit) button as shown below.

1. Right click and select format

2. Select rainbow

3. Click here to display color editor

4. Edit gradient by clicking and dragging line.

5. Right click here to edit color

## 14.1.9 Table Font

- Right click on the column header and select **Format**.
- Change the font using the options in the **Font** panel.

## 14.1.10 Table Alignment

- Right click on the column header and select **Format**.
- Change the font using the options in the **Alignment** panel.

*Rows can be colored by marking them as described here*

### 14.1.11 Mark a Row

A row in a table can be marked and grouped by a label which enables the row(s) to be selected easily at a later time.

#### To mark a row

- Right click on the row in the table you wish to **mark**. Or select multiple rows and then right click.
- Select **Mark Row/** and then choose a number. In the GUI the number of rows that can be marked is limited to 5 but this can be increased using the command line command.
- A row that is marked will be colored – each number is assigned a color. The coloring can be changed in the gui tab in preferences.

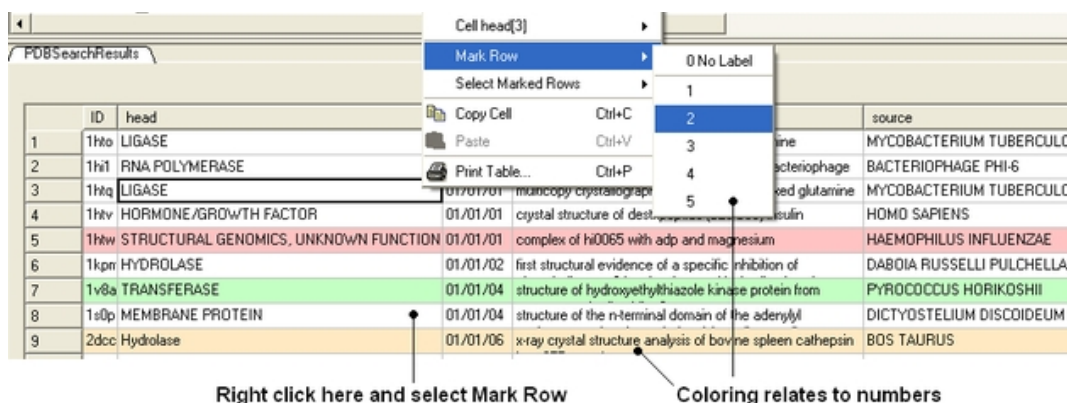

Right click here and select Mark Row

Coloring relates to numbers

#### To select marked rows

- Right click on the table and choose **Select Marked Rows** and choose a number which relates to the marked rows as described earlier.
- Selected rows will be highlighted blue – once rows are selected a number of right click options are activated such as copy selection to new ICM table.

### 14.1.12 Table right click options

Right-click options vary according to where you click and what is selected. The options are intuitive, for example options that are performed on the whole table (eg Save and Delete) are performed by right-clicking on the Table tab. Other right-click options vary according to whether the row or column is selected or not.

### 14.1.13 Rename a Table

#### To rename a table:

- Right click on the table tab and select rename.
- Enter a new name and select OK.

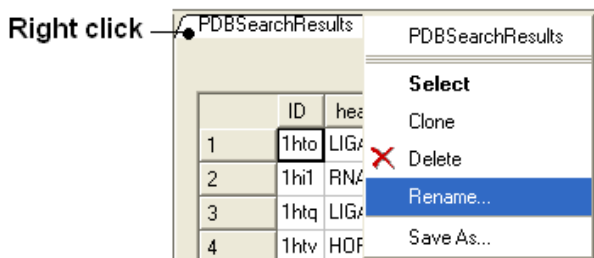

### 14.1.14 Clone a Table

- Right click on the table tab and select clone.

### 14.1.15 Delete a Table

- Right click on the table tab and select delete.

### 14.1.16 Page Setup

Before printing a table you can change the orientation and scale.

To do this:

- Right click on the table header and select **Page Setup**.

### 14.1.17 Print a Table

*A table can be printed by:*

- Right click on the table and a menu will be displayed.
- Select the "Print" option. You may want to change the setup of the table (eg orientation and scale). You can do this using Page Setup option.

### 14.1.18 Export to Excel

To export a table to excel.

- Right click on the table header.
- Select the option to **Export to Excel**.

### 14.1.19 Save a Table

- Right click on the table tab and select Save As..

**NOTE:** You can save your table in comma separated format if you want to read it into another program such as Microsoft Excel.

### 14.1.20 Change Column and Row Width

*To change the width of column and rows:*

You can change the width of a row or column by clicking on the separating line and dragging. You can make each row the same width by holding down the **Shift** key and dragging one of the row edges.

### 14.1.21 Making Table Selections

*To select one column of a table:*

- Click on the column header



Click here to select a column

The screenshot shows a table with 5 rows and 5 columns. The columns are labeled 'ID', 'head', 'date', 'het', and 'title'. The rows contain search results for '\*\*\*'. A callout line points from the text 'Click here to select a column' to the 'head' column header.

	ID	head	date	het	title
1	1sbt	HYDROLASE (SERINE PROTEINASE)	11 Aug 1972		Atomic coordinates for subtilisin BPN
2	1mbr	OXYGEN STORAGE	05 Apr 1973		The Stereochemistry of the Protein M
3	2dhh	OXYGEN TRANSPORT	01 Nov 1973		Three dimensional fourier synthesis c
4	3ldh	OXIDOREDUCTASE, CHOH DONOR, NAD ACCEPTR	06 Jun 1974		A comparison of the structures of ap
5	2cha	HYDROLASE (SERINE PROTEINASE)	01 Jan 1975		The Structure of Crystalline Alpha-Ch

table: 22700 rows, 10 columns

**To select one row of a table:**

- Click on the row header

The screenshot shows the same table as above, but now row 3 is highlighted in blue. A callout line points from the text 'To select a row click here' to the '1' in the first column of row 3.

	ID	head	date	het	title
1	1sbt	HYDROLASE (SERINE PROTEINASE)	11 Aug 1972		Atomic coordinates for subtilisin BPN
2	1mbr	OXYGEN STORAGE	05 Apr 1973		The Stereochemistry of the Protein M
3	2dhh	OXYGEN TRANSPORT	01 Nov 1973		Three dimensional fourier synthesis c
4	3ldh	OXIDOREDUCTASE, CHOH DONOR, NAD ACCEPTR	06 Jun 1974		A comparison of the structures of ap
5	2cha	HYDROLASE (SERINE PROTEINASE)	01 Jan 1975		The Structure of Crystalline Alpha-Ch

table: 22700 rows, 10 columns (1 selected records)

To select a row click here

**To select more than one row or column:**

- Click on one row or column whilst pressing the Ctrl key
- Select multiple number of rows or columns whilst still pressing the Ctrl key

PDB Search results for ""

	ID	head	date	het	title
1	1sbt	HYDROLASE (SERINE PROTEINASE)	11 Aug 1972		Atomic coordinates for subtilisin BPN
2	1mbr	OXYGEN STORAGE	05 Apr 1973		The Stereochemistry of the Protein M
3	2dhb	OXYGEN TRANSPORT	01 Nov 1973		Three dimensional fourier synthesis
4	3ldh	OXIDOREDUCTASE, CHOH DONOR, NAD ACCEPTR	06 Jun 1974		A comparison of the structures of ap
5	2cha	HYDROLASE (SERINE PROTEINASE)	01 Jan 1975		The Structure of Crystalline Alpha-Cr

table: 22700 rows, 10 columns (3 selected records)

Select multiple rows and columns by clicking and selecting whilst pressing the Ctrl key.

**NOTE:** The Ctrl key acts as a toggle enabling select and unselect.

*To select a range of columns or rows:*

- Click on the first row or column in the range whilst pressing the Shift key.
- Click on the last row or column in the range whilst pressing the Shift key.

To select a range of columns or rows - click on the first member of the range and the last whilst pressing the shift key.

PDB Search results for ""

	ID	head	date	het	title
7	3lyz	HYDROLASE (O-GLYCOSYL)	01 Feb 1975		Real-space refinement of the struct
8	1lyz	HYDROLASE (O-GLYCOSYL)	01 Feb 1975		Real-space refinement of the struct
9	6lyz	HYDROLASE (O-GLYCOSYL)	01 Feb 1975		Real-space refinement of the struct
10	5lyz	HYDROLASE (O-GLYCOSYL)	01 Feb 1975		Real-space refinement of the struct
11	2lyz	HYDROLASE (O-GLYCOSYL)	01 Feb 1975		Real-space refinement of the struct
12	1chg	HYDROLASE ZYMOGEN (SERINE PROTEINASE)	01 Mar 1975		Chymotrypsinogen: 2.5-angstrom cr
13	2cna	LECTIN (AGGLUTININ)	01 Apr 1975		The covalent and three-dimensiona
14	1hip	ELECTRON TRANSFER (IRON-SULFUR PROTEIN)	01 Apr 1975		Two-Angstrom crystal structure of o
15	1gpd	OXIDO-REDUCTSE(ALDEHYDE/DONR,NAD/ACCP)	01 Jul 1975		Studies of asymmetry in the three-di

table: 22700 rows, 10 columns (6 selected records) 1 non-ICM

Click here hold the shift key

Click here hold the shift key

*To invert a selection:*

- Right click on the original selection and a menu will be displayed.
- Select the Row Selection/Invert selection option.

**NOTE:** Invert selection can only be used on rows.

*To select the whole table:*

- Right click in the table and a menu will be displayed.

- Select the Row Selection/Select All option.

**To remove a selection:**

- Click anywhere within the table.

A selection can also be made from a plot select(^table-plot{See Select plot section}).

### 14.1.22 Editing a Table

**To edit the contents of a table column:**

- Select the column and then right-click on a column header and a menu will be displayed.
- Select the "Edit Mode" option. A tick will be displayed if it is selected.

OR

**To edit the text or values within a cell:**

- Right click on the table and select **Edit Cells by Double-click** .

**To edit the name of a column:**

- Right click on the column header and a menu will be displayed.
- Select the option "Rename Column..." and enter the appropriate new text.

### 14.1.23 Inserting Columns

**To insert a column:**

- Identify the position within the table where you wish the column to be inserted.
- Right click on the column header and a menu will be displayed.
- Select "Insert Column"

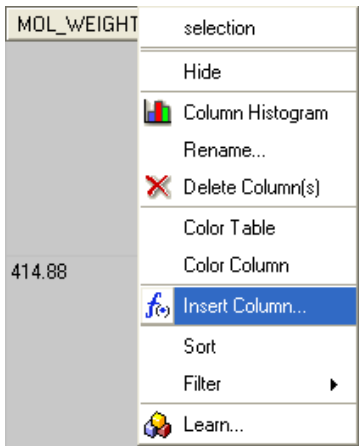

A dialog box will then be displayed as shown below.

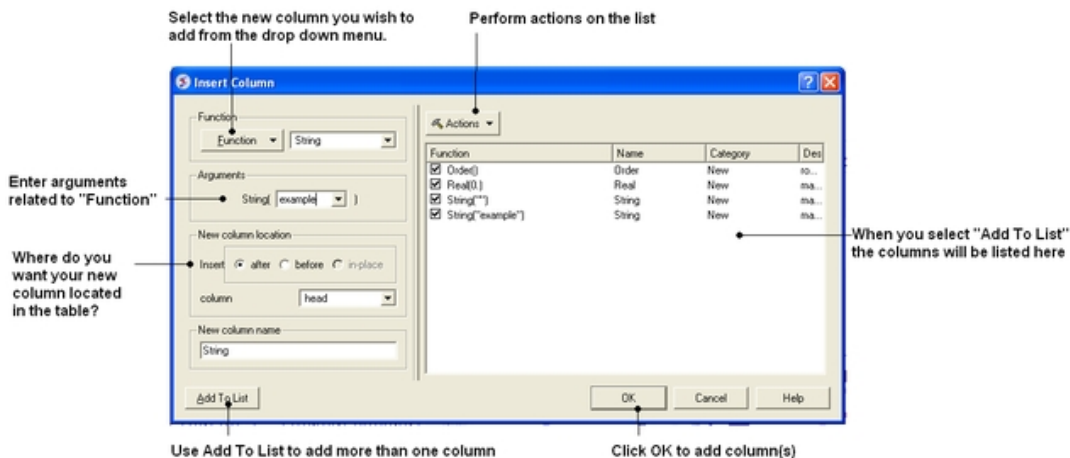

- Select the function you wish to add to the new column. Functions can be applied to many columns e.g. add etc..
- A set of arguments related to the function selected will then be displayed.
- Enter the appropriate arguments related to the function selected.
- Select where you want the new column to be located in the table.
- Enter the new column name
- If you wish to add multiple columns then use the **Add to List** option.

Many different functions are available:

- **New** Add a new column containing a real number, integer, string, or random number.
- **Transformations** A number of transformations can be selected and applied to a table column as shown below.
- **Mathematical** A number of mathematical functions
- **Text** Apply a number of different functions to the text in a column.
- **Chemical** Calculate a number of different chemical properties.
- **Convert Units** Radian to Degrees and Degree to Radian

*Once the function and the correct arguments have been entered:*

- Select whether you wish the new column to be added before, after or in place of this column.
- Enter the name of the new column.

**NOTE:** If you want to add more than one column choose **Add to List** and the action will be added to a list on the right hand side of the dialog box.

## 14.1.24 Column Statistics

*To calculate various statistics describing columns and inter-column relationship:*

- Right click on the column header and a menu will be displayed.
- Select "Column Statistics"

The output is printed into the ICM Terminal window and the Column Statistics Window.

## 14.1.25 Inserting Rows

*To insert a row:*

- Identify the position within the table where you wish the row to be inserted and select the row.
- Right click on the row name (eg the number of the row) and a menu will be displayed.
- Select **Insert Row Before** or **Insert Row After**.

A blank row will be inserted. You can add data to this row by following the instructions in the edit table section.

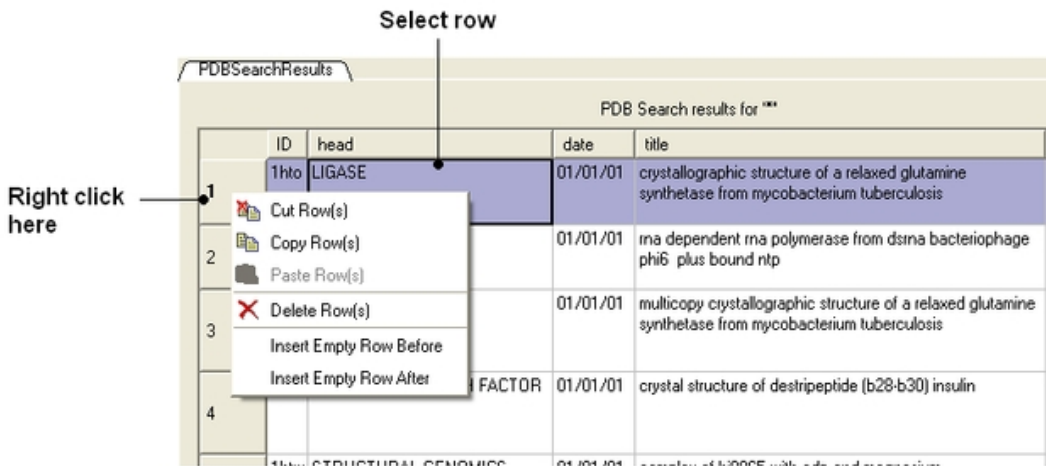

### 14.1.26 Copy Cut and Paste Row

*Copy, Cut and Paste Row:*

- Select the row(s) See table selection section.
- Right click on the row header
- Select **Copy Row(s)**.
- To paste a row select the row header under which you wish to paste the row. Right click and select **Paste Row(s)**

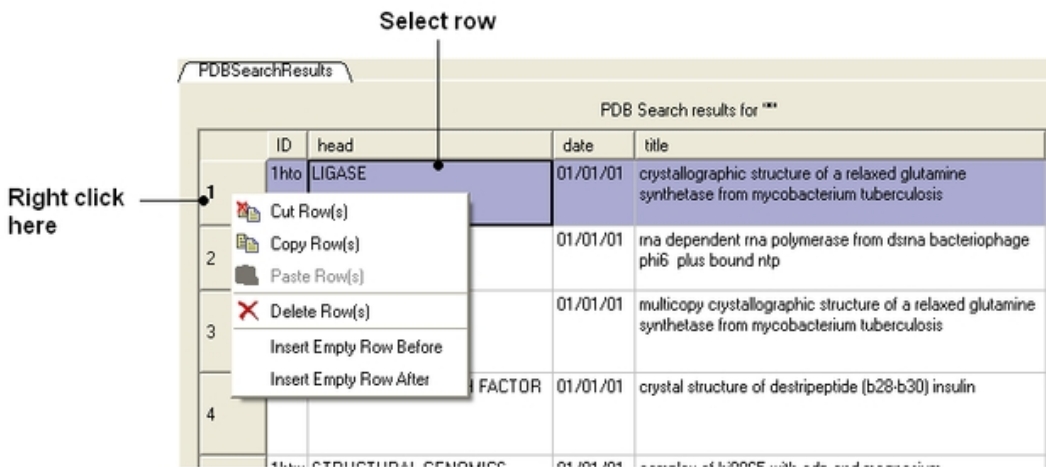

### 14.1.27 Copy Cell

*To copy a table cell:*

- Right click on cell.
- Select Copy Cell – you can then paste it into a new table.

### 14.1.28 Copy Selection to an ICM Table

*To copy a selection to a new table:*

- Select the row(s) See table selection section.
- Right click on the row header
- Select **Copy Selection to ICM Table** and then choose Auto (ICM will name the table or New and you can enter a new table name).

## 14.1.29 Deleting Columns and Rows

*To delete a column or row:*

- Select the column(s) or row(s) you wish to delete. See the `select table` section for information on how to make table selections.
- Right click on the row to delete a row or right click on the column header to delete a column and select the delete option from the menu.

## 14.1.30 Hide and Show Columns

If you have a large table you may wish to only show and display certain columns and hide others. By default any loaded table will have all the columns displayed.

*To select which columns you wish to hide:*

- Select the column(s) you wish to hide. See the `select table` section for information on how to make table selections.
- Right click and select the hide option from the menu.

IX	NAME	Score	Natom	Nflex	Hbond	Hphob	Vwlnt	Eintl
103476	m1	-35.47	33	0	-8.31	-4.97	-33.81	1.49
103485	m1	-44.18	36	1	-10.40	-7.35	-34.44	5.61
103522	m1	-36.40	46	1	-6.74	-7.44	-38.30	1.01
103526	m1	-37.21	31	1	-11.60	-5.32	-34.68	9.26
103547	m1	-33.21	36	0	-7.53	-5.89	-33.12	1.13
103566	m1	-35.13	49	4	-5.13	-7.93	-44.10	4.48

Table: 12923 rows, 13 (of 14) columns

Select column(s), right click and then select the hide option.

*To show hidden columns:*

- Right click on the column header and a menu will be displayed.
- Select the **Show Columns** options.
- Select which column you wish to show from the drop down list.

IX	NAME	Score	Natom	Nflex	Hbond	Hphob	Vv			
103476	m1	-35.47	33	0	-8.31	-4.97	-33			
103485	m1	-44.18	36	1	-10.40	-7.35	-34			
103522	m1	-36.40	46	1	-6.74	-7.44	-38			
103526	m1	-37.21	31	1	-11.60	-5.32	-34			
103547	m1	-33.21	36	0	-7.53	-5.89	-33			
103566	m1	-35.13	49	4	-5.13	-7.93	-44			
103592	m1	-36.01	47	2	-4.39	-7.99	-49			
103614	m1	-36.25	41	5	-8.71	-5.47	-29			
103615	m1	-34.95	49	1	-7.84	-7.68	-38			
103621	m1	-34.46	31	0	-6.87	-5.01	-39.21	2.08	9.51	
103626	m1	-32.70	34	0	-7.00	-4.72	-35.59	2.15	6.61	
103648	m1	-36.11	31	3	-7.40	-5.63	-35.08	4.93	2.93	
103707	m1	-32.11	50	4	-5.91	-7.89	-49.16	2.12	16.18	

table: 12923 rows, 10 (of 14) columns

### 14.1.31 Change Column Format

To change the **font** color or size, the **alignment** of the column data, the **floating** point number or **column name**.

- Right click on the column header and select **Format**

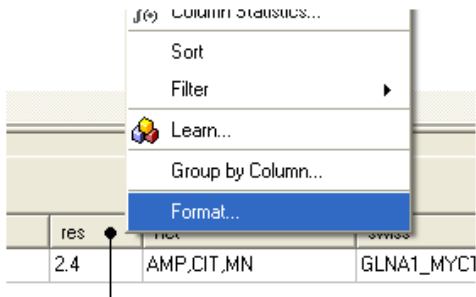

Right click on the column header

- A window as shown below will be displayed.
- Make the desired changes and click **Apply**

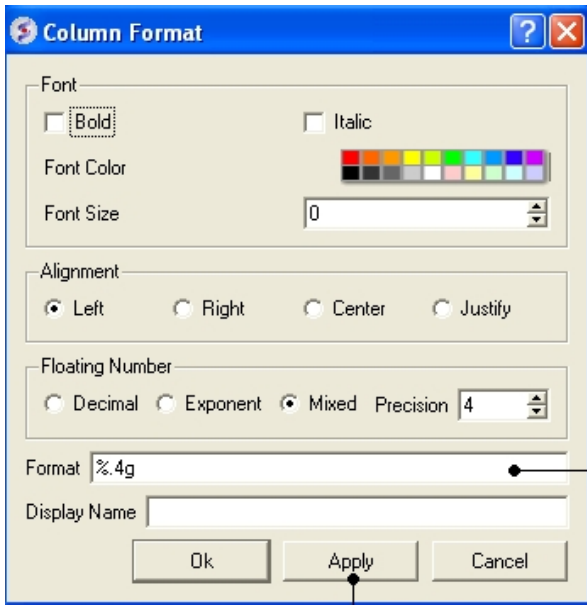

Any changes you make are represented here

Make changes and select Apply

### 14.1.32 Table Sorting

To sort a table by a column value:

- Right click on the column header.
- Select the **Sort** option.

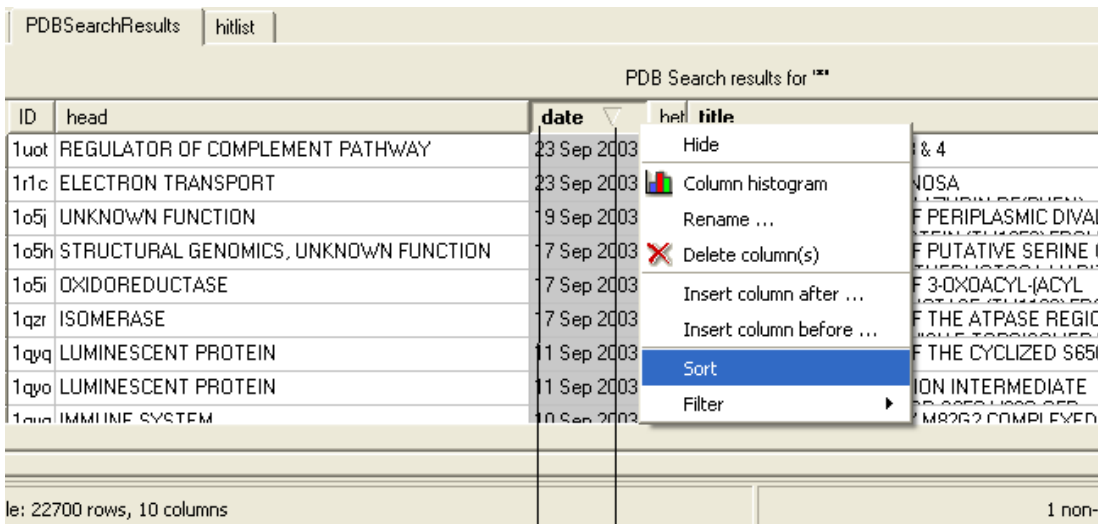

Right click in the column header

The arrow represents ascending or descending order.

### 14.1.33 Table Filtering and Appending

Here we will describe how you can filter your table so that you can then append the filtered data to a new table or display only relevant information to your filter query.

To filter a table:



- Select the column you wish to filter. See the select table section for information on how to make table selections.
- Right click on the column header.
- Select the **Filter** option.

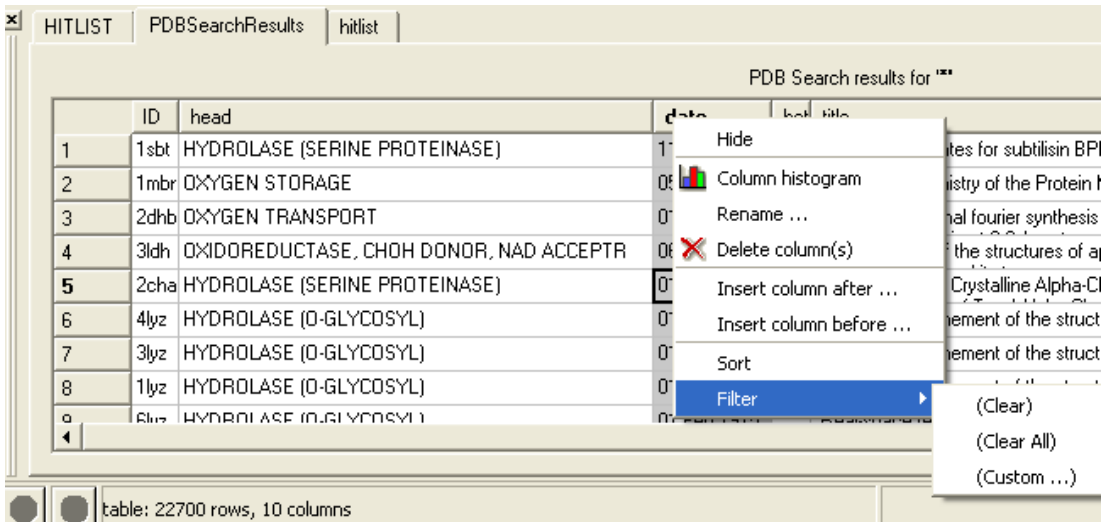

- Select the "Custom" option and a data entry box as shown below will be displayed.
- Enter the appropriate operations and filter values for your search.
- Click OK.



**NOTE:** When a column has been filtered a symbol as shown below will appear in the header of the column.

The screenshot shows a table titled "PDB Search results for '12'" with columns: ID, head, date, het, and title. The 'date' column header has a downward-pointing triangle icon. The table contains 10 rows of data, with the row for ID 21264 highlighted. Below the table, a status bar indicates "table: 1441 (of 22700) rows, 10 columns".

	ID	head	date	het	title
	21260	1njp	RIBOSOME	02 Jan 2003	PPL THE CRYSTAL STRUCTURE OF '...
	21261	1njt	HYDROLASE	02 Jan 2003	ACE COMPLEX STRUCTURE OF HCM'...
	21262	1njs	TRANSFERASE	02 Jan 2003	HUMAN GAR TFASE IN COMPLE>...
	21263	1njq	METAL BINDING PROTEIN	02 Jan 2003	ACE NMR STRUCTURE OF THE SING...
	<b>21264</b>	1njp	RIBOSOME	02 Jan 2003	PPL THE CRYSTAL STRUCTURE OF '...
	21265	1nju	HYDROLASE	02 Jan 2003	DNI COMPLEX STRUCTURE OF HCM'...
	21266	1oa7	HYDROLASE	02 Jan 2003	STRUCTURE OF MELANOCARPL...
	21267	1oa6	HYDROLASE INHIBITOR	02 Jan 2003	THE SOLUTION STRUCTURE OF...
	21268	1oa5	HYDROLASE INHIBITOR	02 Jan 2003	THE SOLUTION STRUCTURE OF...

This symbol means that the table has been filtered according to data within this column.

*To append the filtered information into a new table:*

- Select the whole table either by right clicking or pressing Ctrl A.
- Right click on the table and select "Append to other table".
- Enter a new name for the table you are appending with your filter results.

OR

*Selected rows can be appended to a new table by:*

- Right clicking on the selected rows and a menu will be displayed.
- Selecting the "copy selection to ICM table" option.

*A table can be filtered by a cell value:*

- By clicking once in a cell.
- Right click and a menu will be displayed.
- Select the option "Filter by cell value".

*A filter can be cleared by:*

- Right clicking on the column selection and selecting Filter/Clear or Filter/Clear All

### 14.1.34 Mark and Select Rows

A row in a table can be marked and grouped by a label which enables the row(s) to be selected easily at a later time.

**To mark a row**

- Right click on the row in the table you wish to **mark**.
- Select **Mark Row/** and then choose a number. In the GUI the number of rows that can be marked is limited to 5 but this can be increased using the command line command.
- A row that is marked will be colored – each number is assigned a color. The coloring can be changed in the gui tab in preferences.

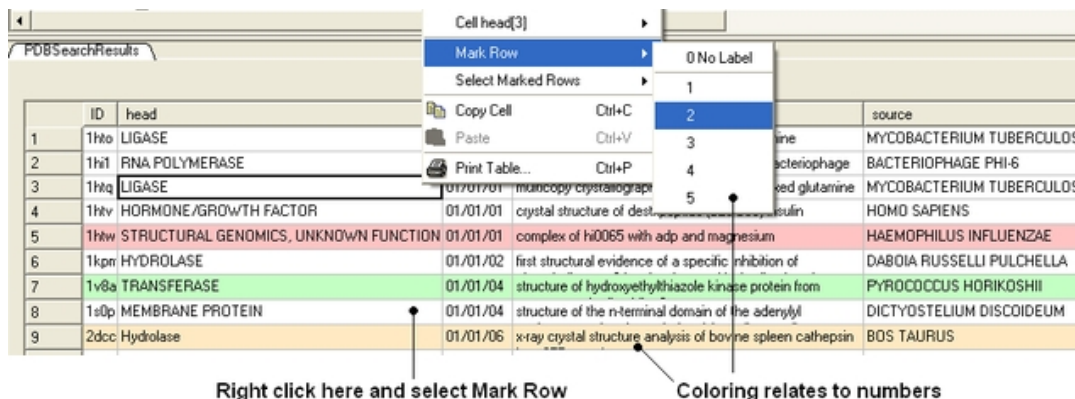

## To select marked rows

- Right click on the table and choose **Select Marked Rows** and choose a number which relates to the marked rows as described earlier.
- Selected rows will be highlighted blue – once rows are selected a number of right click options are activated such as copy selection to new ICM table.

## 14.1.35 Mouse and Cursor Actions on a Table

The actions resulting from a mouse click or cursor on a table can be changed by:

- Right click on a table and select Table View/Show Extra Panel
- A panel as shown below will be displayed.

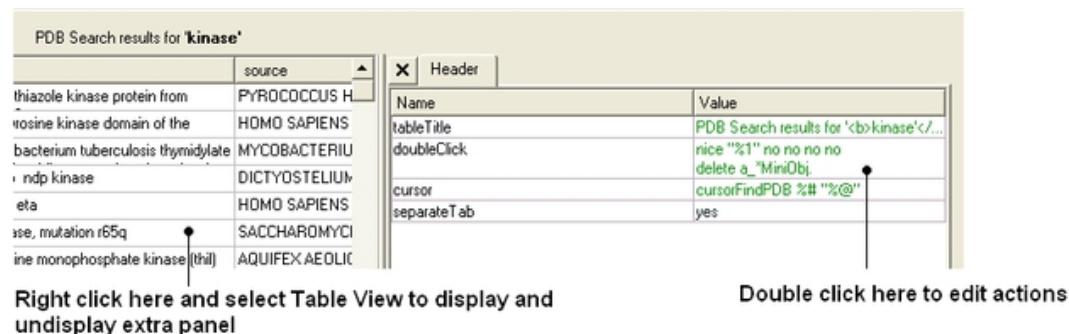

- Double click in the **Value** column and the column can be edited. Add ICM commands for the action you want. A value in a column can be referred to using "%" e.g. column two would be referred to as "%2". In the example shown above the function nice is acting on the contents of column one for the double click action.

NOTE: The action associated with cursor and double click is placed in a variable name TableName.cursor and TableName.doubleClick

## 14.2 Molecular Tables

An ICM molecular table is created when an SDF or Mol file is read into ICM. To read and open a mol or sdf file go to File/Open (See Open an ICM file section) All of the table functions described in the previous section Standard ICM Table can be applied to molecular tables. Molecular tables are described in more detail in the Cheminformatics chapter.

An example of an ICM molecular table:

Table tab      Multiple tables      Add new fields - calculate and predict properties

Lead\_Compounds      Heig

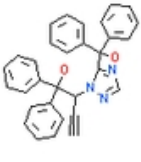
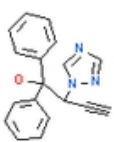
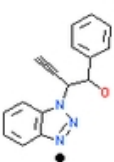
mol	racemic	MolWeight	MolFormula	Nof_RotBonds	vendors
		471.564	C31H25N3O2	8	ufark:24693
2					ufark:24692
3					ufark:14690

Select rows - use CTRL button (non-contiguous) or Shift button (range)

2D Sketch

Right click menu links to a variety of cheminformatics options

- Lead\_Compounds
- ✓ Edit Cells by Double-click
- Table View
- Find in Table      Ctrl+F
- Color By
- Clustering...
- Learn...
- Analysis
- Row Selection
- Insert Row
- Delete Row
- Copy Molecule Image
- Copy Molecule Image To Album
- Save Molecule As Image...
- Edit Molecule...
- Query Molecule
- Chemistry
- Cell mol[5]
- Mark Row
- Selecte Marked Rows
- Copy Molecule      Ctrl+C
- Paste      Ctrl+V
- Print Table...      Ctrl+P

Edit text

## 14.3 Plotting Table Data

The data within a table can be plotted graphically. A histogram can be made for the data within one column or a plot can be constructed for the data within two columns.

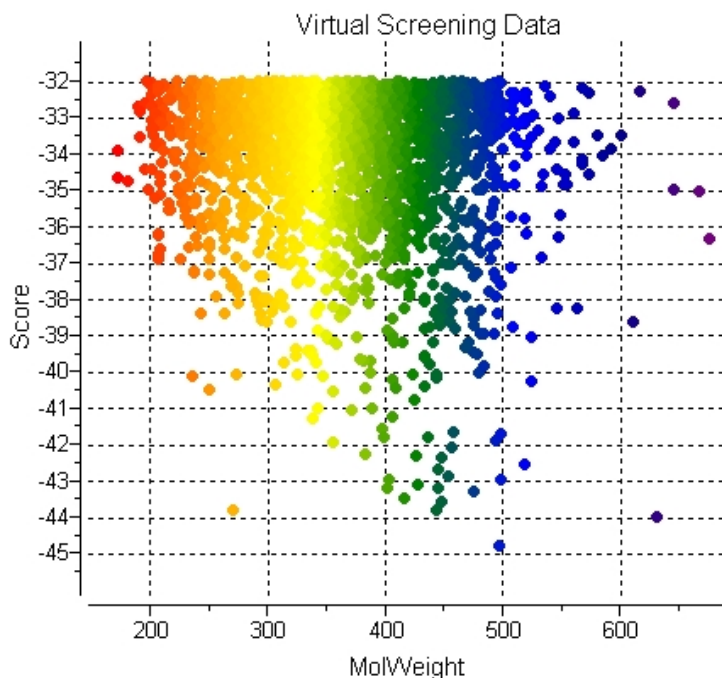

### 14.3.1 Column Histogram

*To plot a histogram of the data within one column:*

- Select the column by clicking on the column header.
- Right click on the column header.
- Select the **Column histogram** option.

Click here to select the column and then right click and select column histogram option

dock\_example

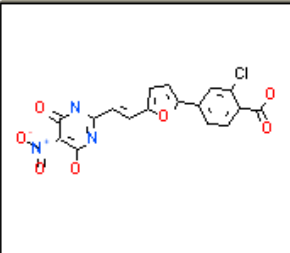
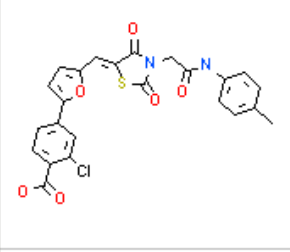
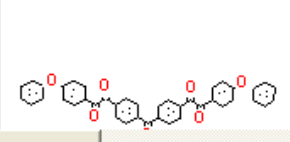
mol	MolWeight	Score
	403.738	-46.19
	496.930	-44.81
	630.660	-44

A plot will then be displayed next to the table.

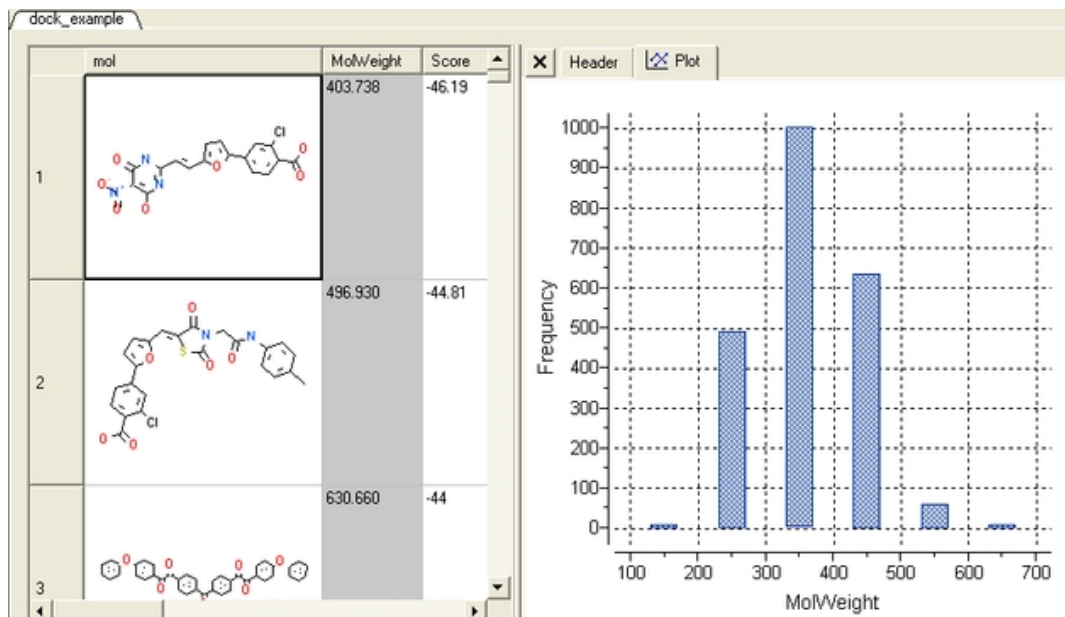

### 14.3.2 Histogram Options

*Once you have created a histogram you can change the following parameters by right clicking on the plot and selecting options*

Options:

- Change plot title.
- Change the data source using the drop down button and select another column in the table.
- Change the histogram bin size.
- Change the bars positioning from vertical to horizontal.
- Change the bar relative width compared to bin size. Bigger values give thicker bars.
- Color the bars

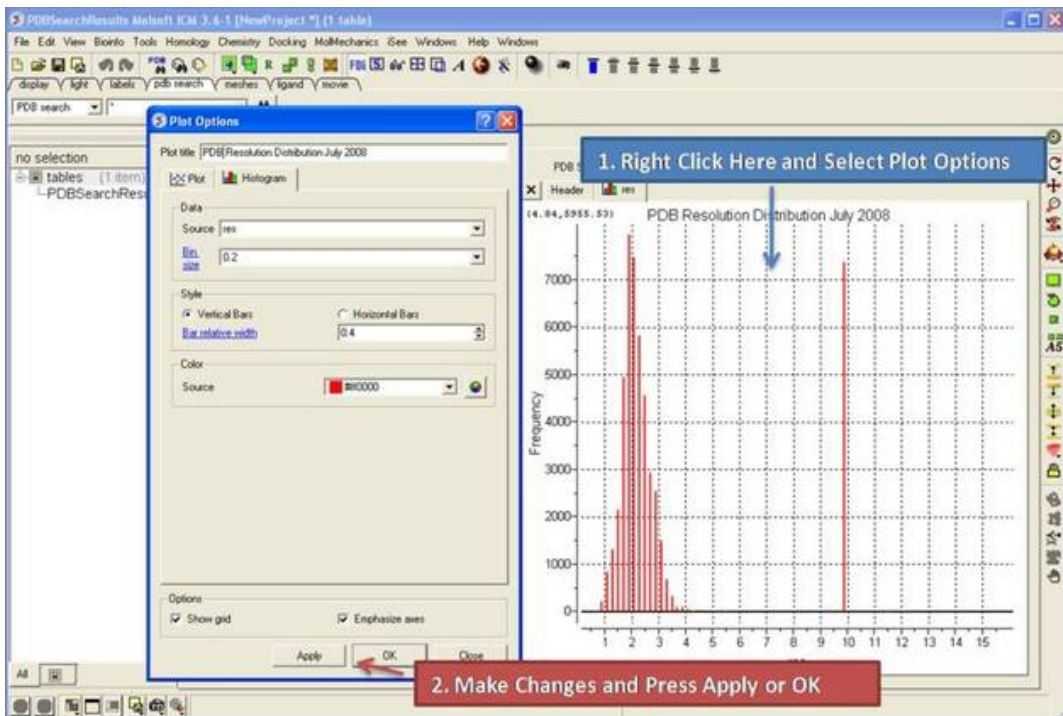

### 14.3.3 Histogram Bins

There are two ways to change the bin size. 1. Using the **options** dialog box or 2. interactively by left clicking and dragging at the top of the plot as shown below – this will allow you to find the best density estimation picture.

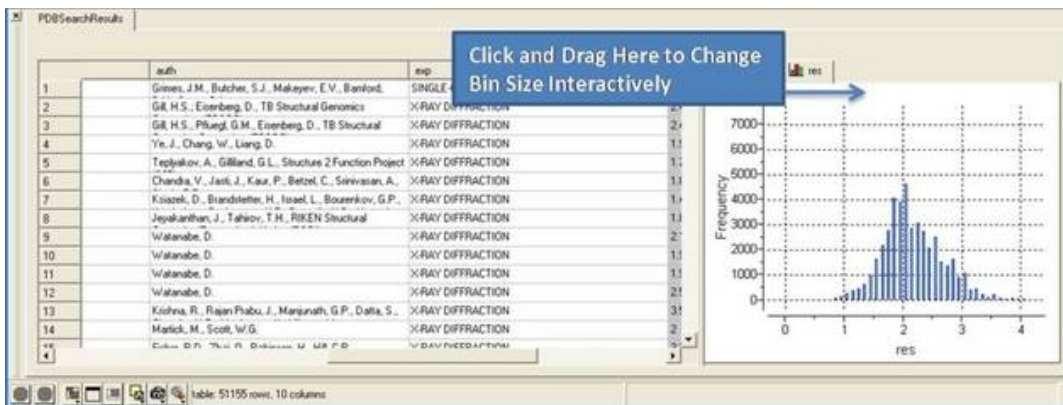

### 14.3.4 Plotting two columns

To construct a plot from data within two columns:

- Select the two columns.
- Right click on the column header.
- Select the **Columns** plot option.

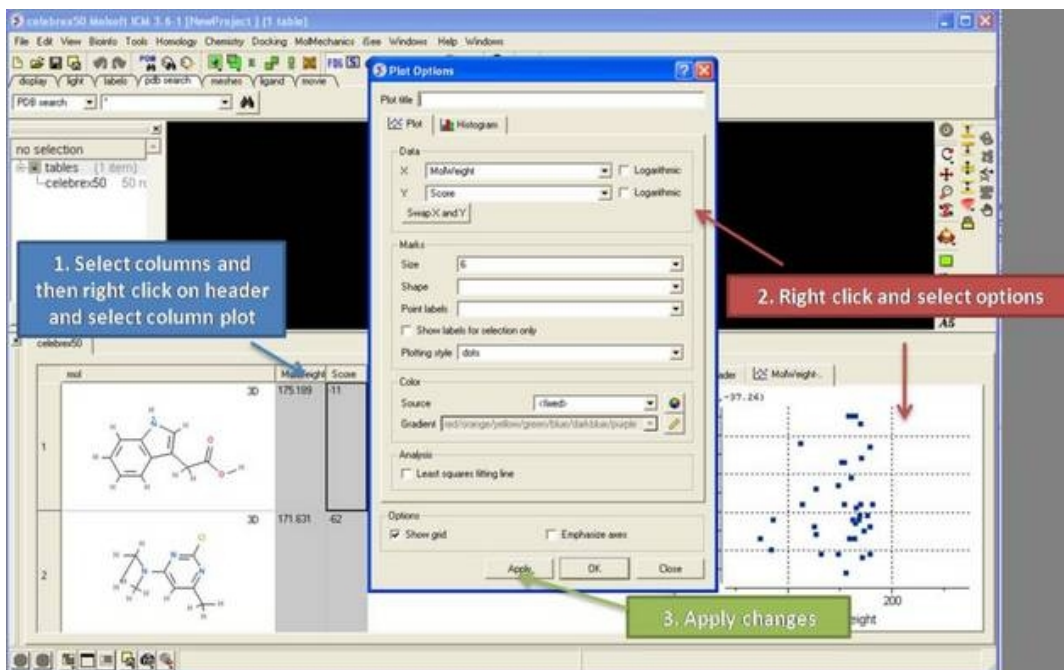

### 14.3.5 Add a title to a plot

To add a title to a plot:

- Right click on the plot and select **Edit Title** or choose **Options**

### 14.3.6 Axis Options

Each axis has a set of options which can be accessed by right clicking on the axis and selecting **Options**.

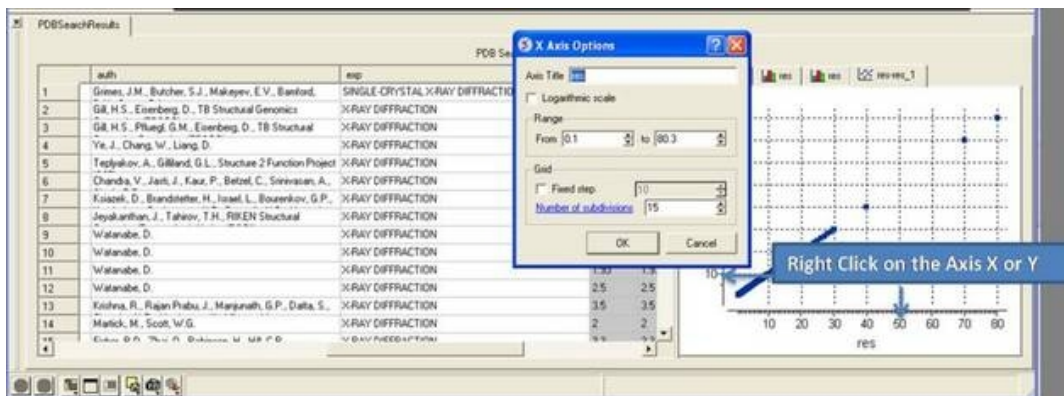

To change the title of the X or Y Axis:

- Right click on the axis and select **options**

To change the data range:

- Right click on the axis and select **options**
- Change the **From** and **to** values in the **Range** box

To change the Grid steps (ticks) on the X or Y axis:

- Select either a fixed step e.g. 10 and you can define the number of subdivisions (ticks) in each step. Choosing 1 will display zero ticks between divisions.



*To change the axis to logarithmic*

- Right click on the axis and select **options**
- Select the Logarithmic scale check box

### 14.3.7 Change Axis Data

*To swap the X and Y axis:*

- Right click on the plot and select **Options**.
- Select the **Swap X and Y** button.
- Click OK.

*To change the data source for either the X or Y axis:*

- Right click on the plot and select **Options**.
- Select the drop down arrow as shown below and select a different column from the table.
- Click OK.

### 14.3.8 Logarithmic Plots

*To change the scale of the axis to logarithmic:*

- Right click on the plot and select **Options**.
- Select the **Logarithmic** check box.

### 14.3.9 Change Mark Shape or Size

*To change the plot mark, shape, style or label:*

- Right click on the plot and select **Options**.
- Select the desired size and shape using the drop–down buttons in the **Marks** section of the window.

*To add point labels:*

- Right click on the plot and select **Options**.
- Select the drop down arrow in the **Point labels** dialog box
- If you only want to label selected points check the **Show labels for selection only** option. Making plot selections is described [here](#).

### 14.3.10 Change Mark Color

*To change the color of the plot marks:*

- Right click on the plot and select **Options**.
- In the **Color** section of the window select the **Source** (column name plotted as X or Y) you wish to color.
- Select the color palette and choose the desired color or you can choose a Gradient of colors.

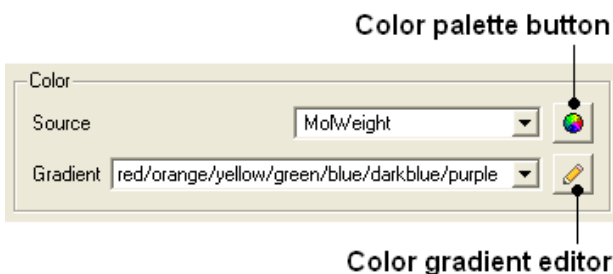

*To edit the color gradient*

- Click on the **Color gradient editor** button and a window as shown below will be displayed.
- Click and drag on a mark in the gradient plot to change the color gradient.
- Right click on a color in the Y-axis to – **Edit, Duplicate or Remove Color**.
- The color gradient can be applied to all points in the data or for a fixed range.

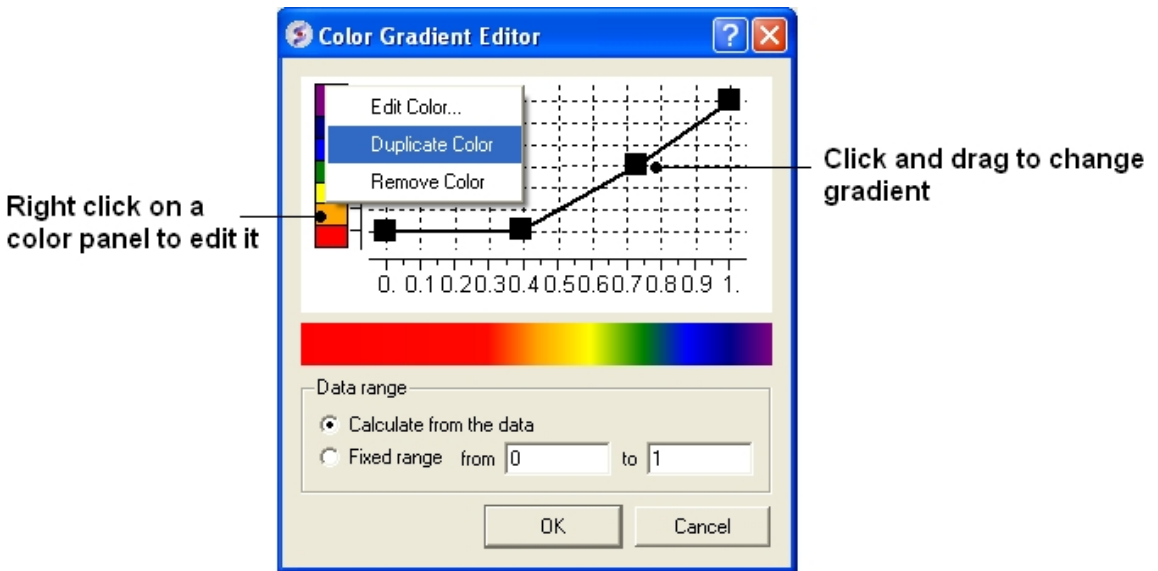

### 14.3.11 Grid and Axis Display

*To remove the grid display and/or highlight the axes:*

- Right click on the plot and select **Options**.
- Check the **Show grid** or **Emphasize axes** options.

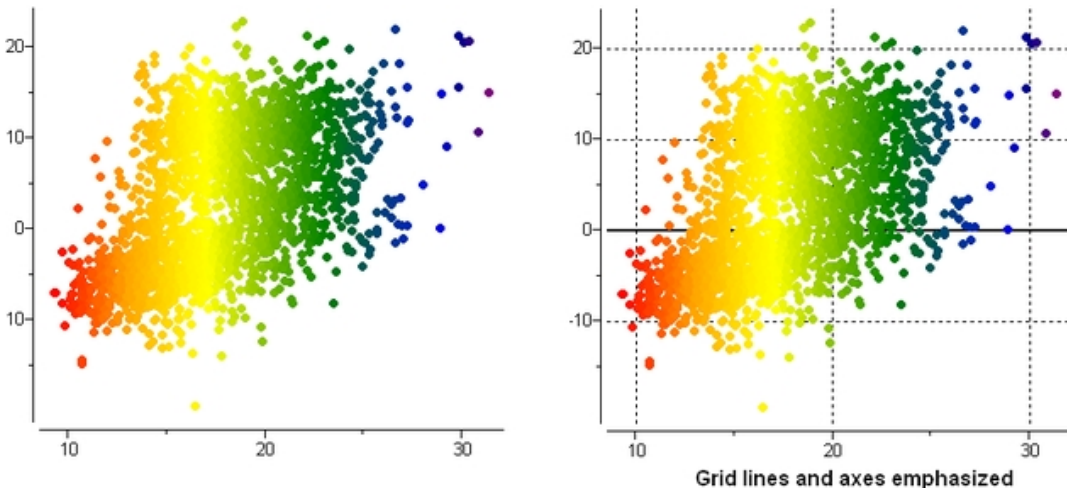

### 14.3.12 Least Squares Fitting

*To fit the data to a straight line using least square fitting*

- Right click on the plot and select **Options**.
- Select the check box for **Least squares fitting line**.

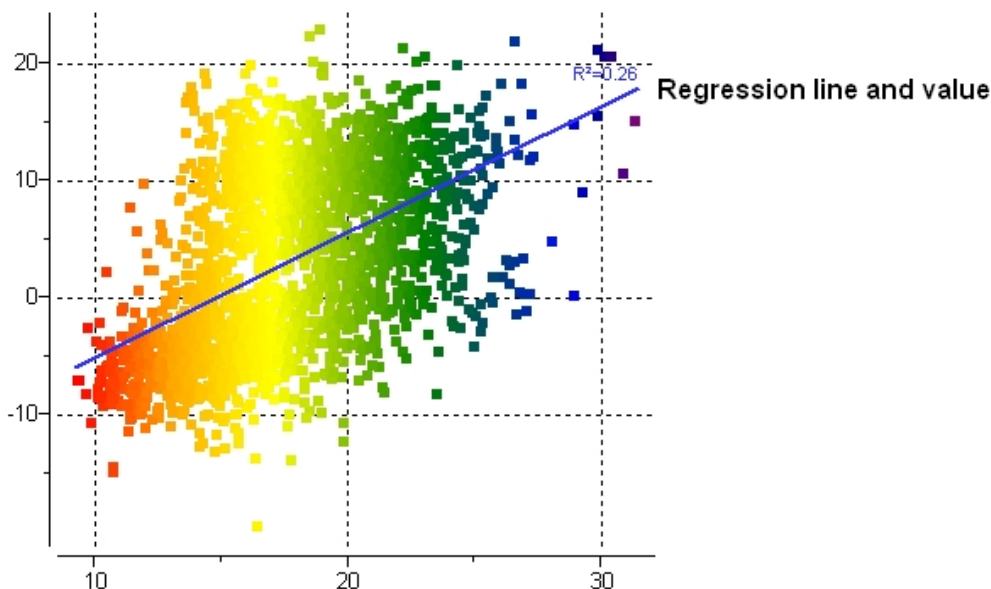

### 14.3.13 Zoom, Translate and Center

*To zoom into a plot:*

- Click outside the plot on the left-hand-side and drag the mouse or use the middle mouse wheel to zoom in and out.

*To translate a plot*

- Click, hold and drag using the middle mouse button on the plot.

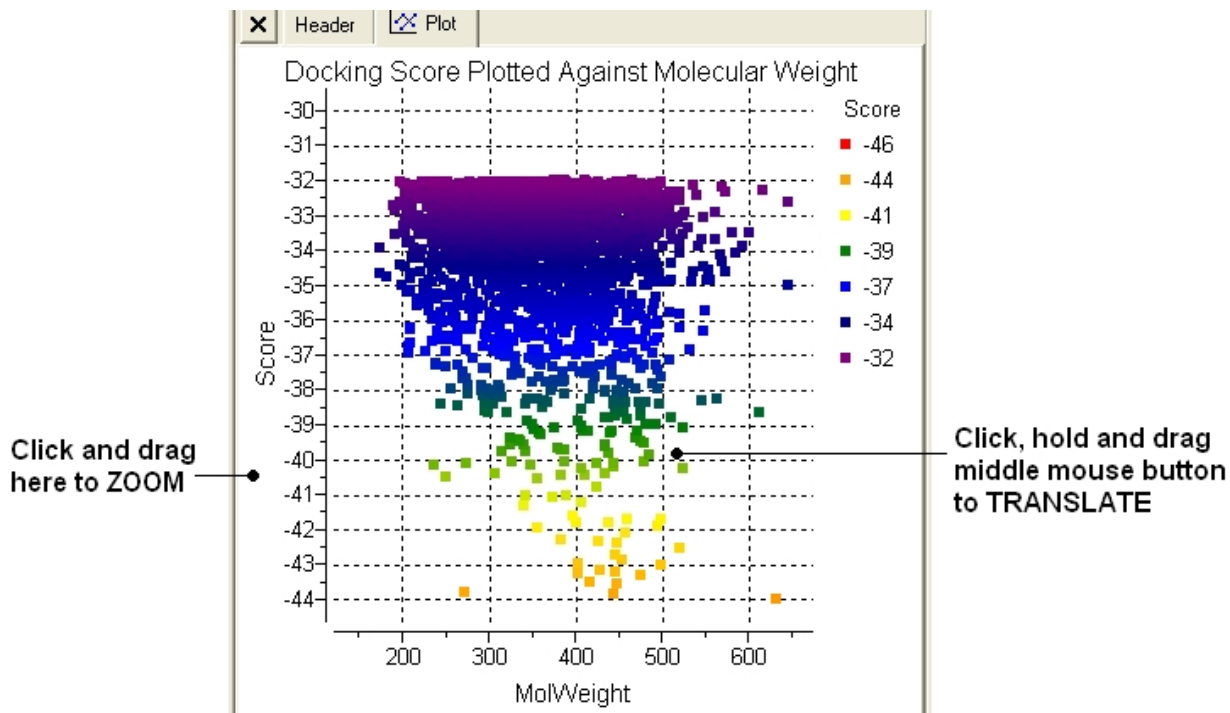

*To center onto a plot*

- Right click on the plot and select **Center all** or **Center Selection**. Making selections in a plot is described in the next section.

### To center into an axis

- Right click on the axis and select **center**.

### To zoom into an axis

- Hover the mouse over the axis until you see a blue rectangle surrounding the axis.
- Use the middle mouse wheel to zoom in and out as shown below.

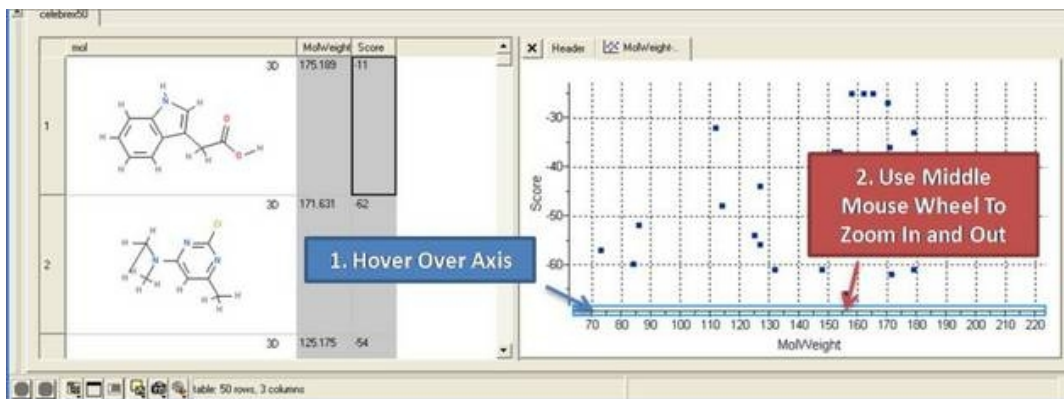

## 14.3.14 Plot Selection

### To make a selection in a plot:

- Click and drag in the plot to make a selection. Individual points can be selected with a single click.

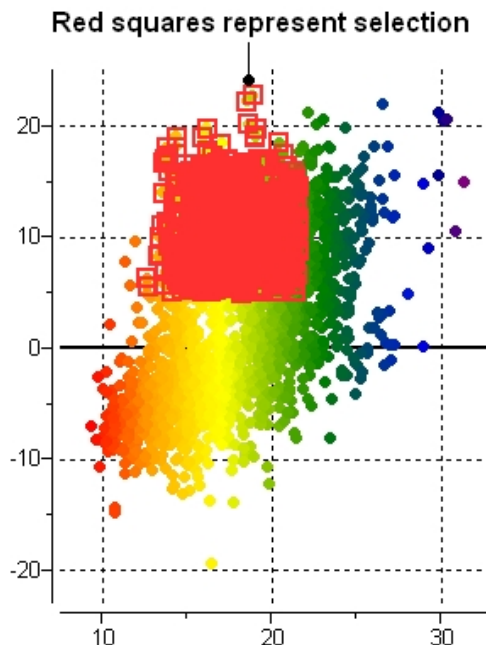
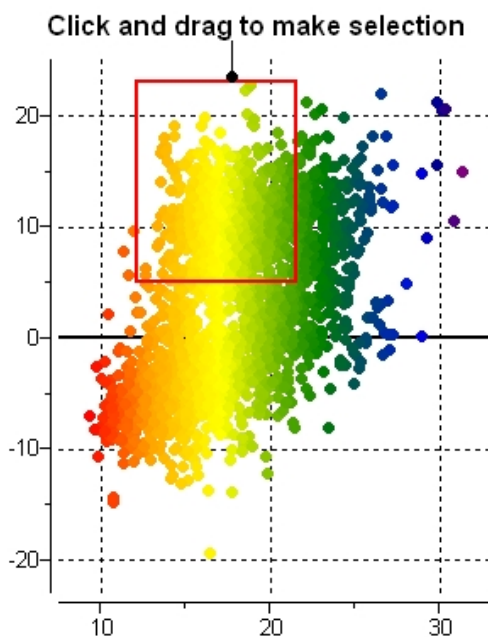

All selections are directly linked to the table from which the plot was made. Selections in the table are highlighted in blue.

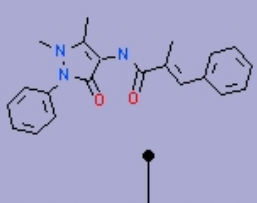
2088		47	0	-36.91	0
------	---	----	---	--------	---

Selection highlighted in blue in a table

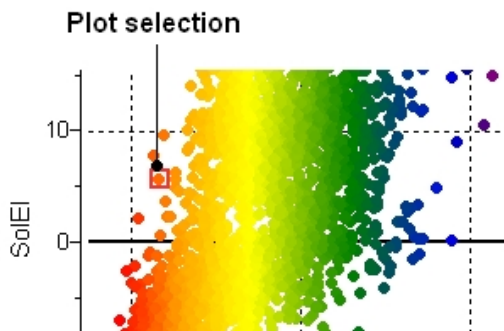

*Non-contiguous selections in the plot can be made by holding the CTRL key.*

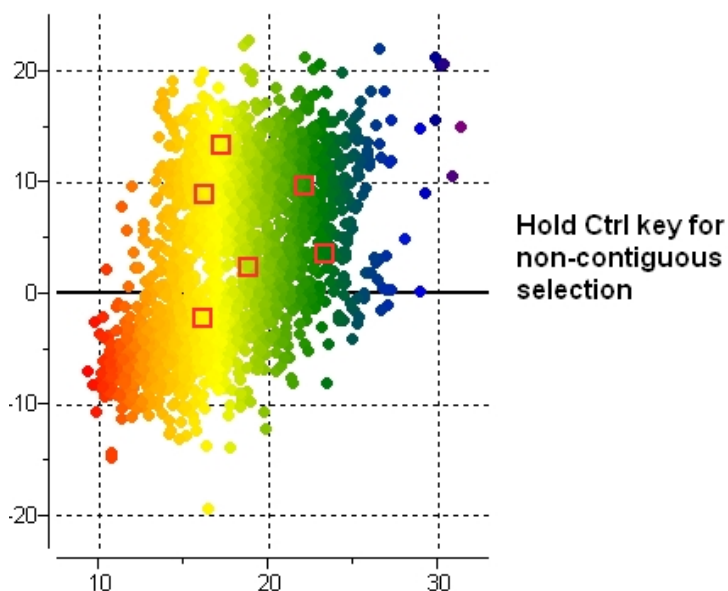

### 14.3.15 Print Plot

*To print a plot:*

- Right click on the plot and a menu will be displayed.
- Select the print option.

### 14.3.16 Saving a Plot Image

*To save a plot image or copy to clipboard:*

- Right click on the plot and a menu will be displayed.
- Select the **Save/Export Image** option.

### 14.3.17 Table Inline Plots

*Plots can be inserted into a table row by:*

- Select the columns you wish to plot.
- Right click on the column header and select **Inline Plots**
- The plot will then be displayed in each row of the table.

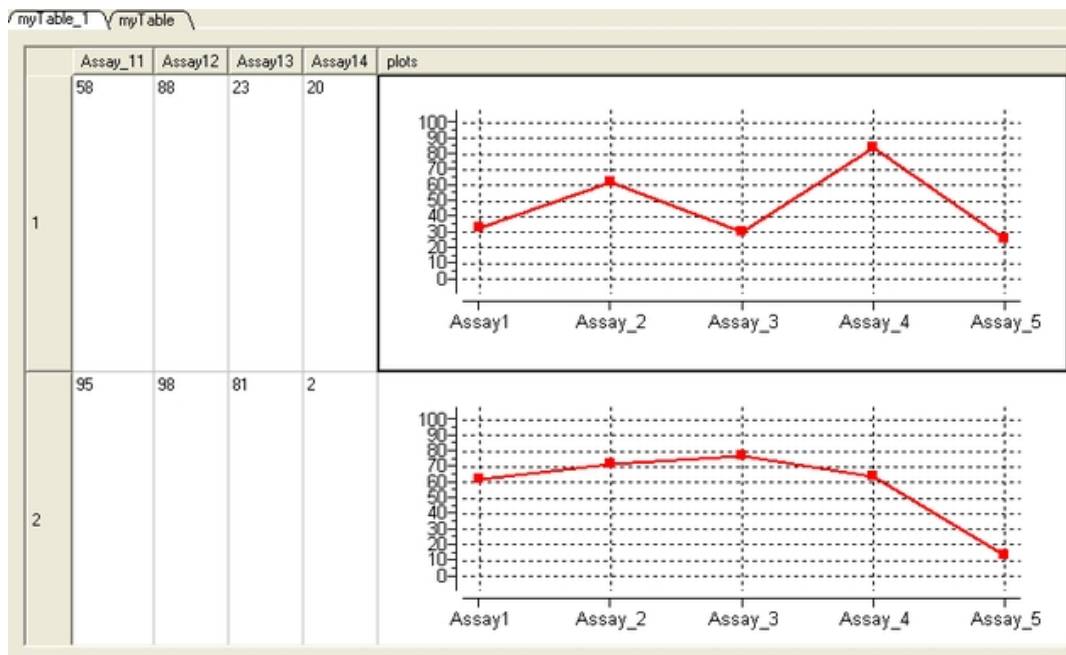

## 14.4 Principal Component Analysis

Principal Component Analysis (PCA) is the younger brother of ICM's more powerful data analysis tools, like `property prediction` and `clustering`, though it still may give a good description of the data with a few columns or even chemical compounds. PCA is a mathematical procedure that transforms a number of correlated variables into a number of smaller uncorrelated variables known as Principal Components. The first component accounts for as much of the variability as possible with the rest of the components accounting for the remainder. PCA may be very helpful when you believe the data actually contains only a few meaningful components. Principal components are linear combinations of the provided data columns.

To perform a PCA analysis a table (either chemical or standard ICM table) needs to be loaded into ICM. For information regarding ICM Tables and ICM Chemical Tables please follow these links.

### *To begin the PCA procedure*

- Right click on a ICM Tables and ICM Chemical Table and select the PCA option. It is important to right click inside the data table and not on a column or row header in order to see the correct menu on which `pca` is listed.
- Select which columns you wish to incorporate into the PCA analysis.

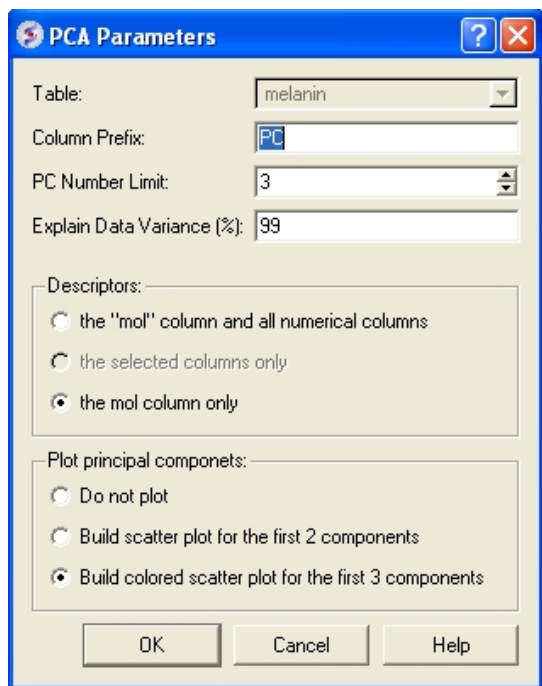

- Enter the table name on which you wish to perform the PCA analysis. If only one table is loaded this option will be greyed out.
- Enter the number of Principal Components (PC number limit) you wish to generate. Generally 3 principal components may be effectively visualized and it will be enough often to fulfil the data variance percentage requirement (see next option). The value displayed in the terminal window under the heading "cumulative explained data variance" will show what percentage of data relates to each PC.
- Enter a value in the "Explain Data Variance (%)" data entry box (99% is the default value) if you prefer this indirect way of limiting number of PC. The algorithm will stop when either PC number or explained variance limit is reached, so if you want only one of this criteria to work, make sure that the other limit is weak (by assigning accordingly the number of PC limit a high value, e.g. 50, or setting data variance to 100%).
- Select which descriptors you would like to include in the PCA analysis.
- Select which plot you would like to display. If you choose to display a plot use the color key on the side of the plot and the information contained within the ICM terminal window to relate which axes and points relates to which PC. PC3 is usually the color in the plot with the values displayed in the plot key.
- Click OK and if selected a plot will be displayed on the right-hand-side of the table. Points within a plot are linked to the table and can manipulated as other plots contained within a table.

## 14.5 Learn and Predict

Partial Least Squares (PLS) and Principal Components are commonly used methods which are implemented in ICM to predict compound properties or any other variable. There are many tutorials in the web available for free download. For the details of ICM implementation and the explanation of our terminology see the theory section below.

In order to perform 'learn and predict' in ICM information must be stored in a table, molecular table or csv file. See the tables chapter for more information on ICM tables. Both chemical compounds and numeric data can be source for building prediction models.

All molecular property predictors are calculated using fragment-based contributions. We developed an original method for splitting a molecule into a set of linear or non-linear fragments of different length and representation levels and then each chemical pattern found is converted into a descriptor.

## 14.5.1 Learn

First load in a table of data on which you wish to perform the learn and predict functions. See the `tables` chapter for more information on ICM tables.

- Select Tools/Table/Learn and a window as shown below will be displayed. Or use the Chemistry/Build Prediction Model option.
- Enter the name of table with which you want to perform the predictions. You may locate your table from the drop down arrow menu.
- Select the column from which you wish to learn. Use the drop down arrow to select.

**NOTE** If the table does not contain any numeric (integer or real) columns, there is nothing to predict, so the "Learn" button will be disabled.

- Enter a name for the learn model.
- Select which regression method you wish to use from the drop down menu. See the `theory` section to determine which method and parameters to use.
- Select which columns (descriptors) of your table you wish to use to 'learn'.
- If you are using chemical descriptors to produce your model select the maximal chain length.
- Select the number of cross-validation groups you wish to use or selected rows can be used for cross validation. The number of iterations will impact the speed of the calculation. 5 is the default number of groups but 2 would be the least rigorous and selecting the 'Leave-1-out' would be the most rigorous calculation.
- Click on the learn button and a table summarizing your model will be displayed as shown below.

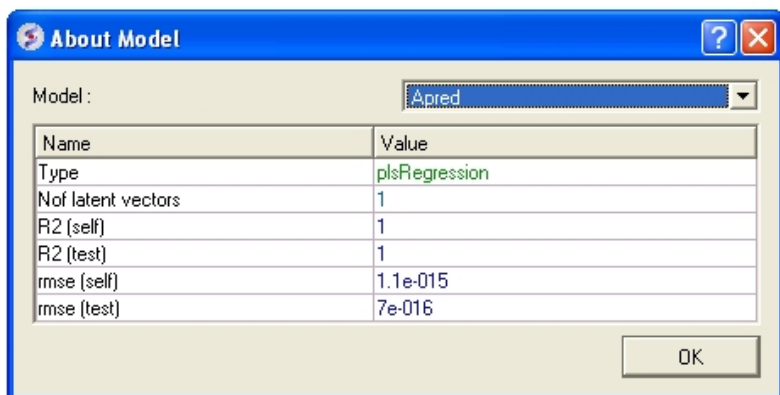

- Click OK and this table will be removed.

All models are then stored in the ICM workspace as shown below. A number of options are displayed in the right click menu.

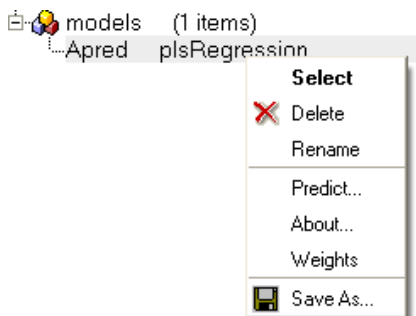

## 14.5.2 Predict

To make a prediction using a created model.



Read the table of data into ICM from which you wish to predict. Make sure the table contains the same columns used for the `learn` model.

- Tools/Table/Predict or Chemistry/Predict
- Select which table you wish to make the prediction on.
- Select which model you wish to use.
- Check that the required columns are in the table. If they are absent a red mark will appear against the column that is missing.
- Click Predict.

### 14.5.3 A little theory on learning

For a more detailed explanation of the theory behind Partial Least Squares (PLS) we suggest you read Geladi et al *Analytica Chimica Acta* (1986) 1–17.

**PLS (Partial Least Squares) Regression** PLS regression algorithm builds linear prediction model: in format  $y = (w, x) + b$ , where  $b$  is the **bias** – a real number, and  $w$  is the weights vector, which is scalarly multiplied by the data vector  $x$ . PLS uses the given learning  $y$  values very actively which allows it to produce fairly good models with respect to constraint of being linear. Although linear regression models have an advantage of weights for each descriptor which gives a useful information and allows feature selection in many cases.

The linear model simply is not able to predict higher order dependencies.

There are different ways to deal with it. By adding the second order columns into the descriptor set you can let PLS predict them. Actually if you have a lot of columns derived from basic data, the linear model built will be able to make a high-quality linear approximations of the actual functions. ICM has a powerful tool for automatical generation of such descriptors based on compound data — molecule fingerprints generation algorithm. It generates hundreds of columns based on initial data. The withdraw is that analysing the weights given by PLS to generated descriptors is almost senseless. You will need a *mol* column in your table to use this feature.

ICM has built-in models for prediction of several significant molecule properties, like logP, logS, PSA based on fingerprints+PLS symbiosis, which have proven their quality.

### PC (Principal Component) Regression

PCR also builds linear model in its simplest form, as PLS does, though it sets other weights to descriptors, and built models are usually worse in sense of predicting, because PCR uses *value* information of the *training data* only in secondary way. We recommend you to use PCR, when you want to build an ordinary regression (MLR – Multiple Linear Regression) model by using only some number of first principal components of X data matrix (ordered by decreasing eigenvalues) or even building the full MLR model (by setting the number of PCs to value higher than the number of rows in matrix).

### 14.5.4 Data Clustering

ICM allows you to create hierarchical clusters for chemical and other objects. Cluster trees can be used for:

- Navigation through large data sets.
- Selecting group representatives (taxons).
- Filtering tables to exclude redundancy.
- Finding similar elements, and more.
- Creating hierarchical views of data sets in many different styles, with subsequent image export/printing ability.

## 14.6 Cluster

To perform clustering based on chemical similarity or any other data you must have an SDF file or table loaded into ICM.

- Right click on the table and select the Clustering option OR select the Chemistry menu and choose the option entitled **Cluster Set**.

OR

- Tools/Table/Clustering.

A data entry box as shown below will be displayed.

- Select which table from the drop down menu you wish to cluster.

There are two clustering methods:

1. A rigorous tree approach (advice to use this with 10000 compounds or less). This clustering algorithm consists of 2 steps: calculation of distance matrix (based on chemical fingerprints for chemical data) and the hierarchical clustering itself. Usually most time is being spent on first step.
2. A less rigorous K-means approach. This option is quicker but the generated tree is not detailed down to the level of table rows. The elements within the table are colored and numbered according to their clustered group.

If your computer has enough memory we recommend you use the TREE method. It takes ~6 minutes to cluster 10000 compounds on a standard computer with 512Mb of memory.

**NOTE** If you wish to cluster a selection of a table; first select the compounds you wish to cluster (Ctrl A will select all or see the section of the manual entitled making table selections).

When using the TREE method select which linkage type you wish to use:

- UPGMA (unweighted pair group method using averages): Distance calculated is the average of all elements (recommended).
- Single linkage: Nearest neighbour linkage
- Complete linkage: Furthest neighbour linkage
- WPGMA (weighted pair group method using averages): Rough approximation of weighted (slightly faster)

Check the option "Keep Distance Matrix" if you wish the Distance Matrix to be saved.

- Click the RUN button and the tree and table will be displayed as shown below.

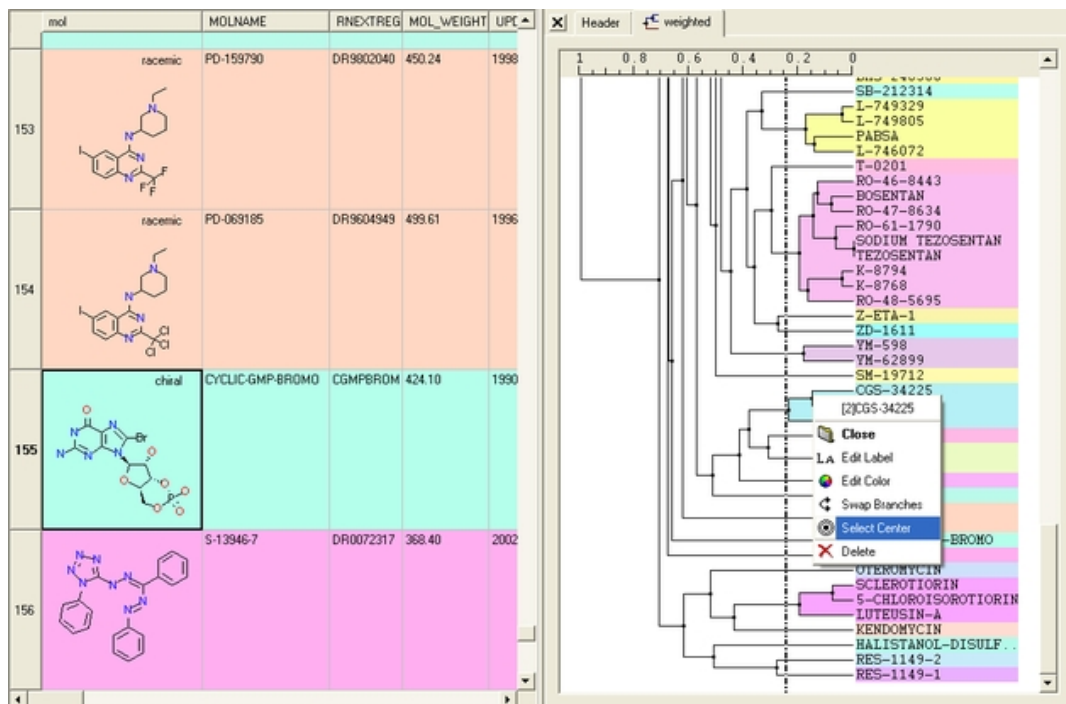

### 14.6.1 Tree Selection

A number of different selections can be made once the tree has been created.

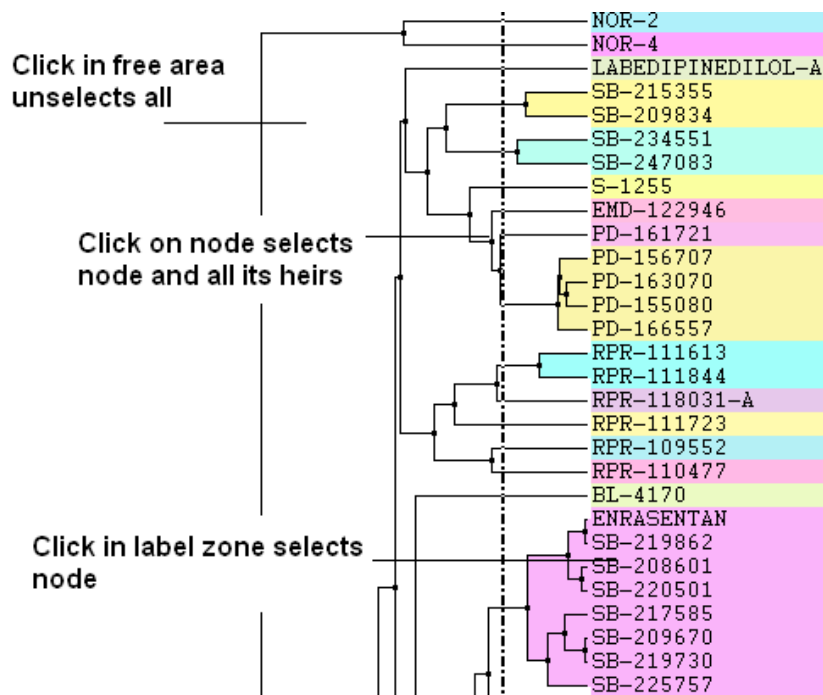

- Click in free area unselects all.
- Click on node selects node and all its heirs.
- Ctrl-click adds to (if not selected yet) or removes from (if already in selection) current selection.
- Shift plus click allows a range to be selected.

- Click in label zone selects node.
- Keyboard "Up"/"Down" cursor keys move selected node up/down in the tree. With Shift held the selection expands in the according direction.
- Keyboard "Escape" unselects all.

### Select Center Representatives From a Node.

To select the "center" representative compound or value from a cluster.

- Right click in the free area of the tree and select the option "Select Centers".

**NOTE:** Selections in the tree will be highlighted in blue in the tree and in the table.

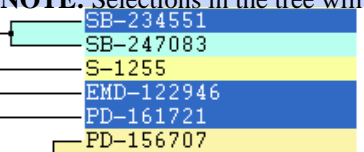

### Copy selection to new table.

All selections can be copied to a new table by:

- Right clicking on the selected rows in table and a menu will be displayed.
- Selecting the "copy selection to ICM table" option.

## 14.6.2 Save and Print Tree

### To save a tree

Option 1:

- Save the whole session as an ICM project. See [Saving an ICM project](#)

Option 2:

- Save the table as an .icb file. Right click on table header and select "save as".

### To save a tree as a picture

- Right click in the "free area".
- Select "Save Image..."

The image of the tree can also be saved to the clipboard.

- Right click in the "free area".
- Select "Copy Image to Clipboard"

### To print the tree

- Right click in the "free area".
- Select "Print"

## 14.6.3 Tree View

A number of changes to the tree view can be made by right clicking in the tree "free area" and selecting preferences as shown below.

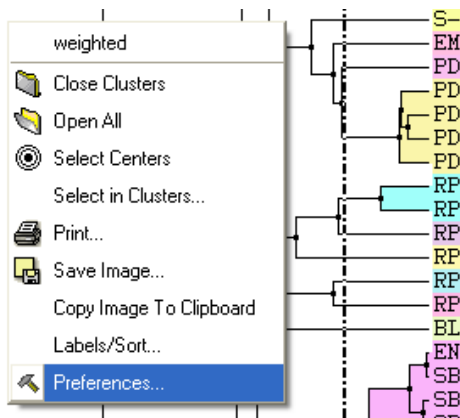

A preferences window as shown below will be displayed.

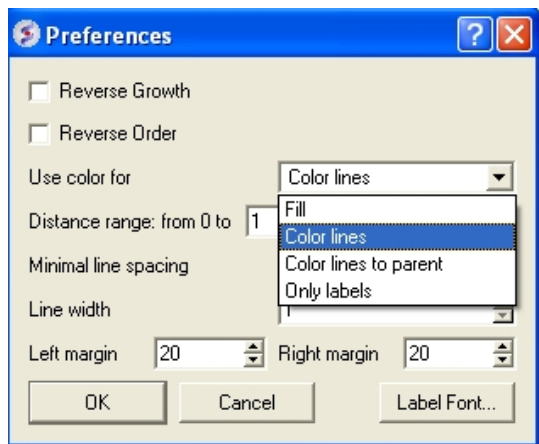

**Reverse Growth:**

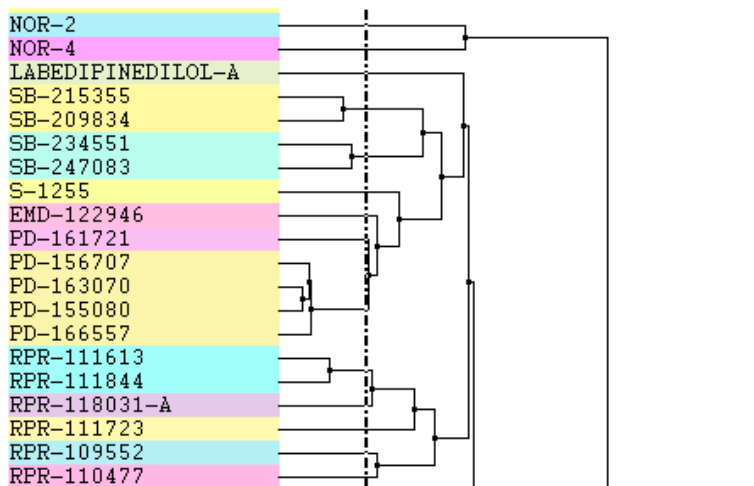

**Distance Range:**

### Distance range changes scale here

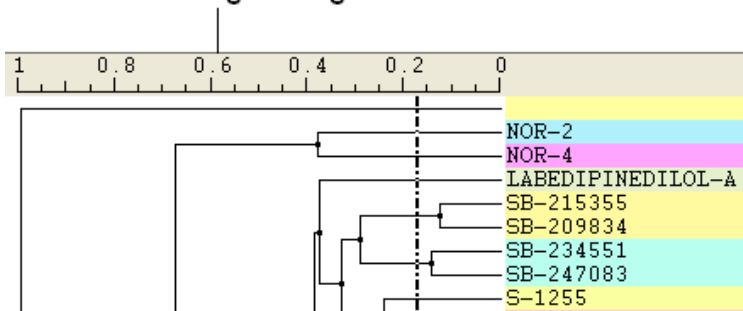

### Color Preferences:

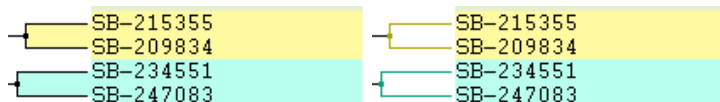

**Left:** Fill **Right:** Color Lines

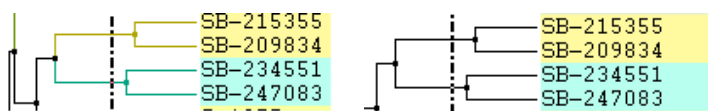

**Left:** Color lines to parent **Right:** Only labels

### Increase or Decrease Line Spacing:

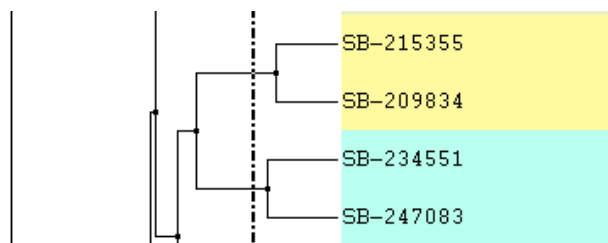

### Increase or Decrease Line Width:

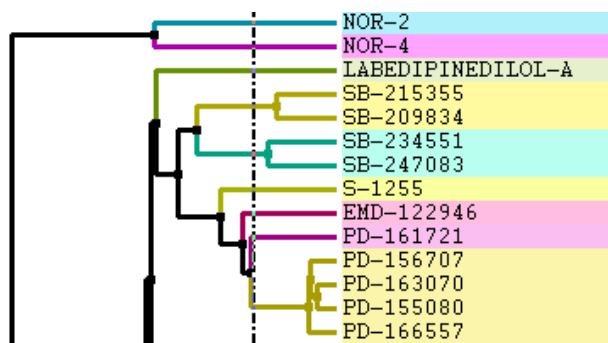

### Change Font and Margins:

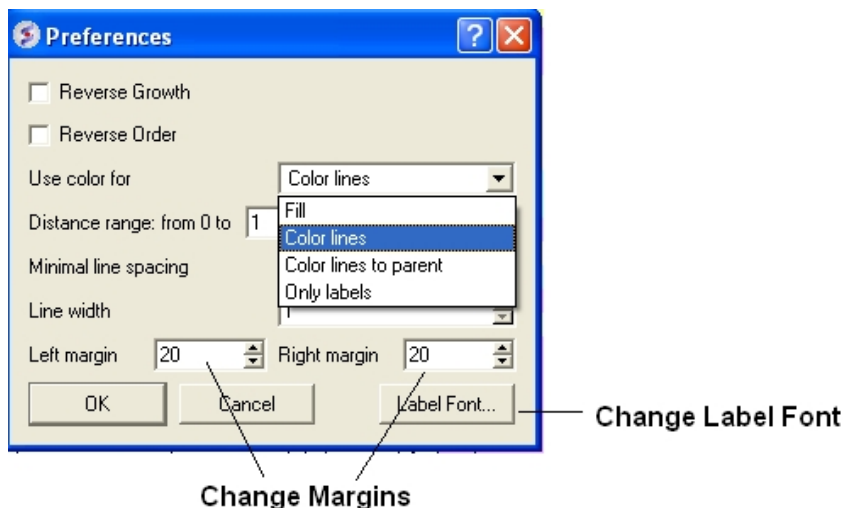

### Change Label

To change the tree labeling (GLOBAL):

\* Right click in the "free area" and select the Label/Sort option.

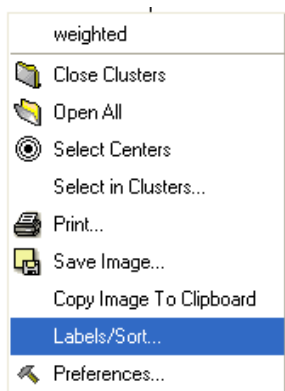

A window as shown below will be displayed:

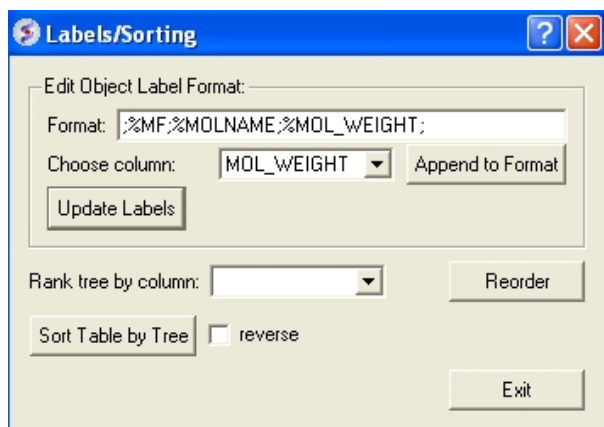

- Choose the column name you wish to label the elements of your tree.
- Click the Append to Format button. You may wish to delete some of the information in the Format data entry box if you do not wish that column header to be displayed. Note more than one column header can be used as a label.
- Click the update labels button to view the changes.

To change the tree labeling (NODE):

- Right click on the node you wish to change the label of and select "Edit Label" and a data entry box as shown below will be displayed.

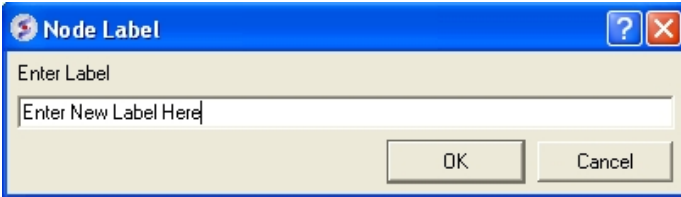

- Enter the new label.

### **Change Node Coloring**

To change the color of a node:

- Right click on the node you wish to change the color of and select "Edit Color".
- Select the desired color and click OK.







# 15 Working with Local Databases

ICM tables are capable of storing tens of thousands records. However, some problems operate with data sets so large that they do not fit in computer's memory. To work with such large amounts of data ICM uses the concept of Molsoft database (MOLT) files. Unlike many other table file formats, such as SDF, CSV and others, database files are optimized for fast search and other operations, like unique entry addition and diverse subset selection.

Database files do not provide all the functionality available for tables but they allow the user to organize large amounts of data, search data using various advanced criteria and share created data collections with other users. For large amounts of chemical data database files provide specialized chemical functionality.

ICM provides the following database file operations:

- create database files from SDF, CSV/TSV, SMILES files and from ICM tables;
- impose unique constraints on certain columns upon table creation to avoid redundancy;
- store multiple tables in a single file; rename, delete tables in a database file;
- search fast using advanced conditions, including advanced chemical search;
- select diverse subsets from chemical database files;
- browse database tables using flexible filtering and sorting conditions;
- directly edit/delete/insert entries in the database;
- export in popular formats, such as SDF (for chemistry) and CSV;
- export and import tables to and from Molcart.

## 15.1 How to make a local database.

There are two ways to convert a file into MOLT format.

1. File/Convert to Local Database
2. In the ICM Chemical Search window as shown below.

Both approaches will display the **Database Import** dialog box.

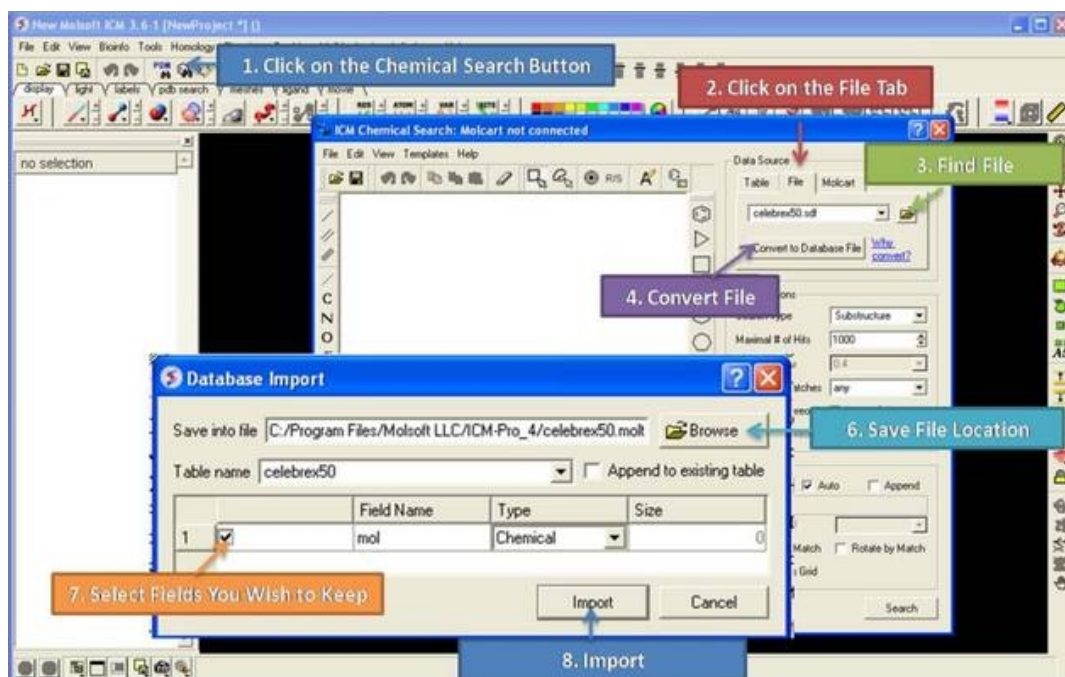

- Once the file has been converted to MOLT and imported then it will be displayed in the ICM Workspace.
- Double click on the file name in the ICM workspace and the database browse mode will activated.

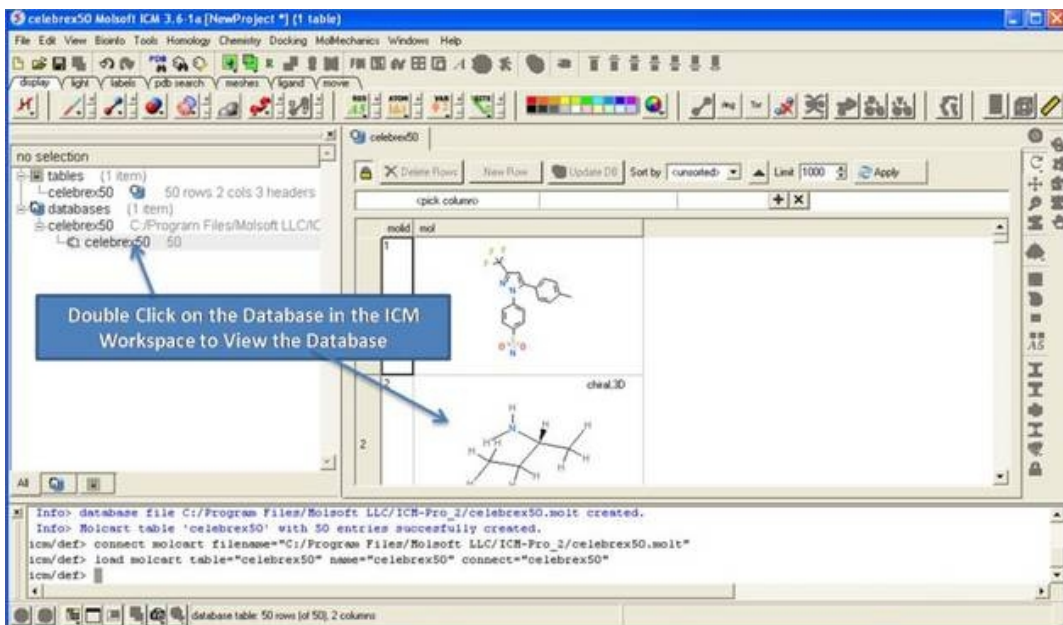

## 15.2 Browse Database

*To browse a database first decide how many rows of your database you wish to view*

- Double click on the file name in the ICM workspace and the database browse mode will activated.
- Select the number of rows you wish to be displayed in the **Limit** data entry box.
- Click on the **Apply** button.
- Scroll up and down the displayed rows using the scroll bar on the right hand side of the table.

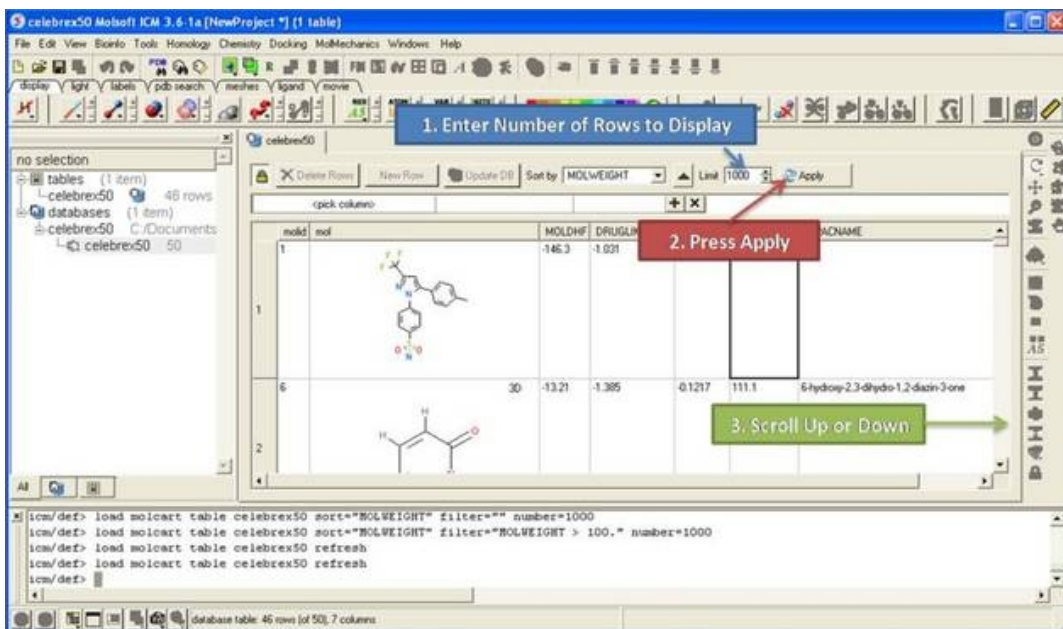

*To sort a database by a value in a column*

- Click on the drop down arrow next to the **Sort by** data entry box and select a column.
- Click on the **Apply** button.

**NOTE:** The database will be sorted globally not just the displayed rows.

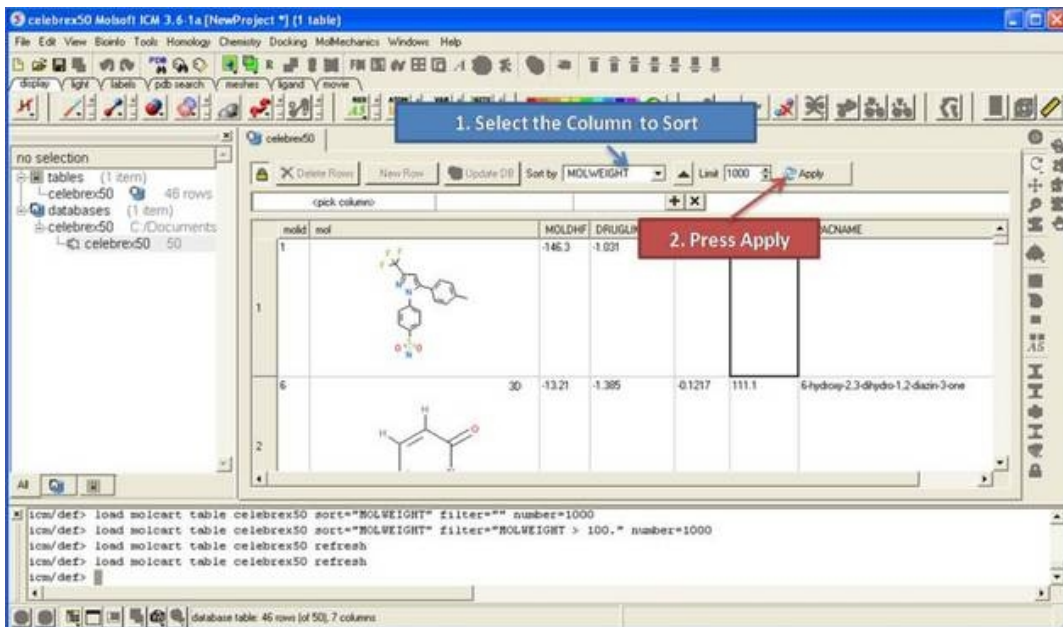

### To filter a database:

- Double click on the panel labeled and the filtering tools will be activated.

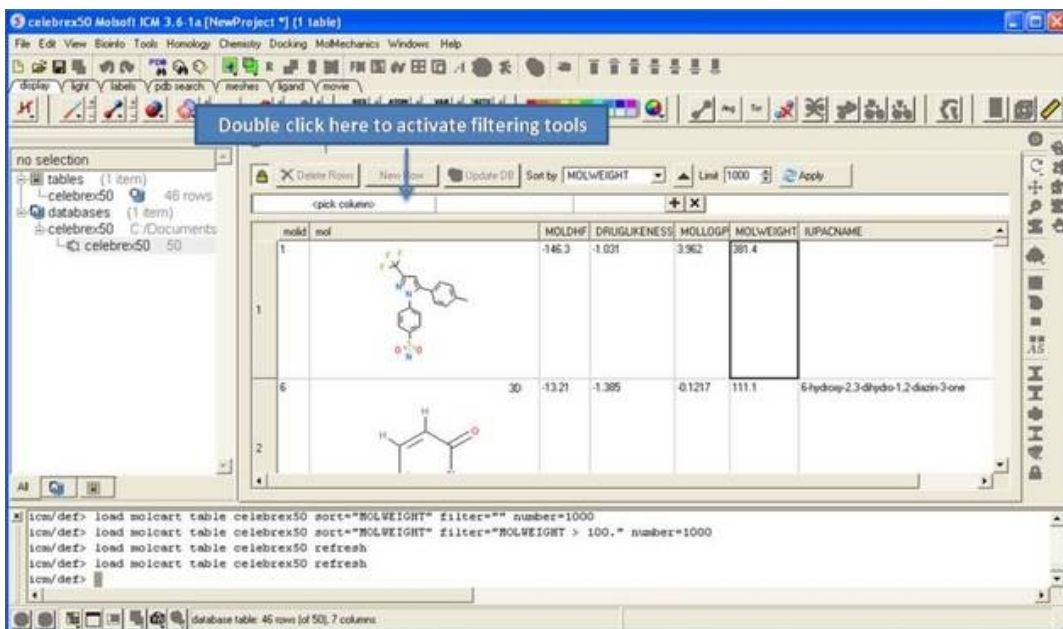

- Click and select a column to filter (as shown below).
- Enter a condition.
- Enter a value.
- Add or remove another condition
- Click the **Apply** button

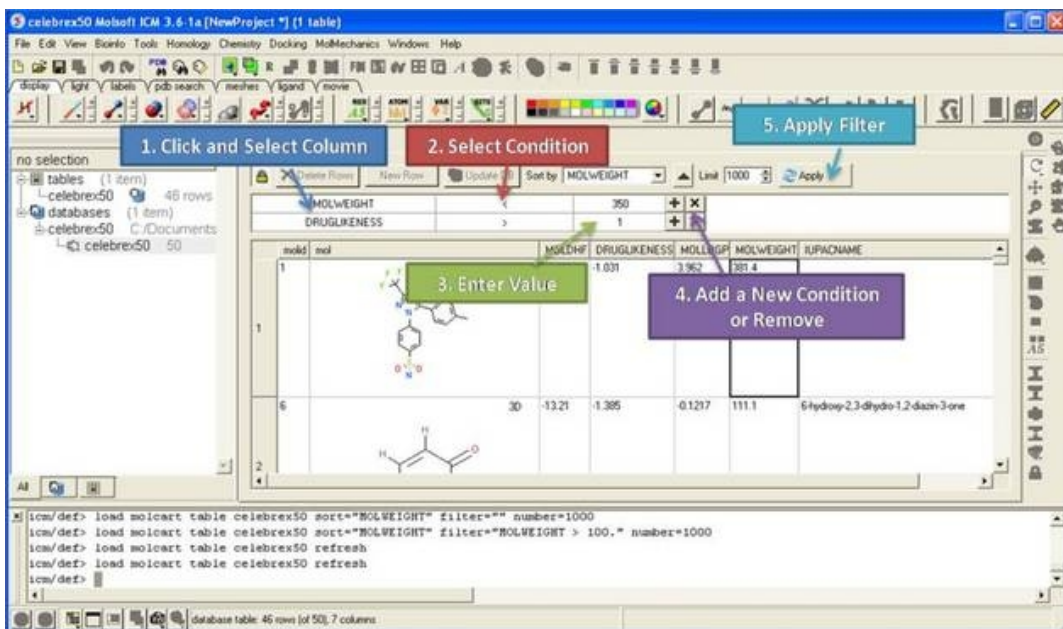

To view a diverse set of rows from your database:

- Right click on the database in the ICM Workspace and select **Select Diverse Set**.

## 15.3 Edit Database

To make any changes to a database you must first unlock it:

- Click on the **Allow editing rows** button which has a picture of a lock on it.
- Once this button has been selected the **Delete Rows**, **New Row**, and **Update DB** buttons will become activate.

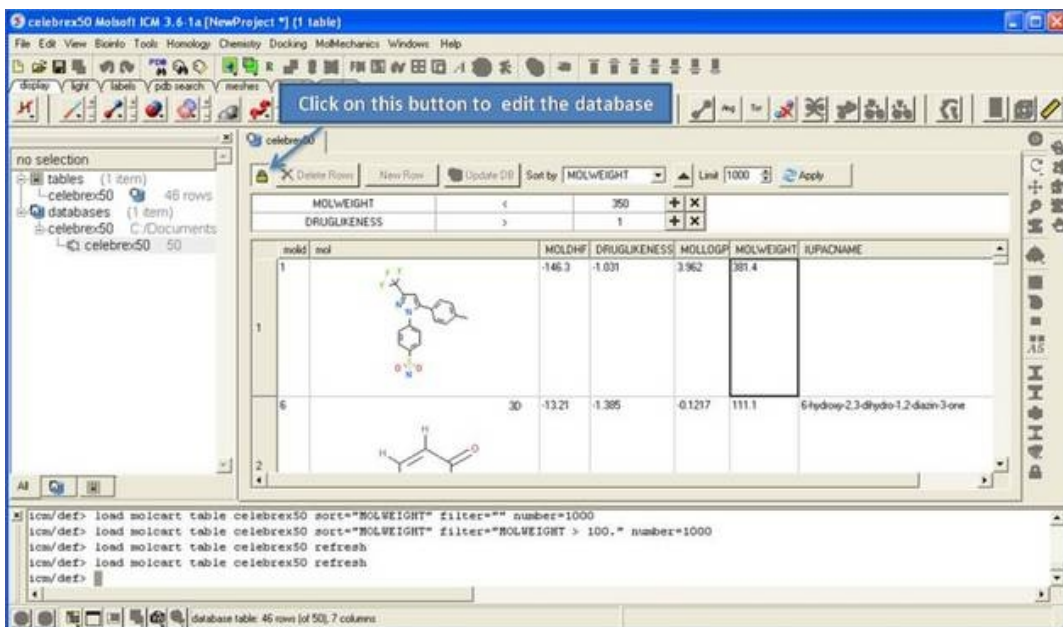

To delete rows

- Select the row(s) by clicking on the row numbers. A range of rows can be selected by holding the shift key and clicking a non-contiguous set of rows can be selected by holding down the control key.

- Click the **Delete Rows** button.

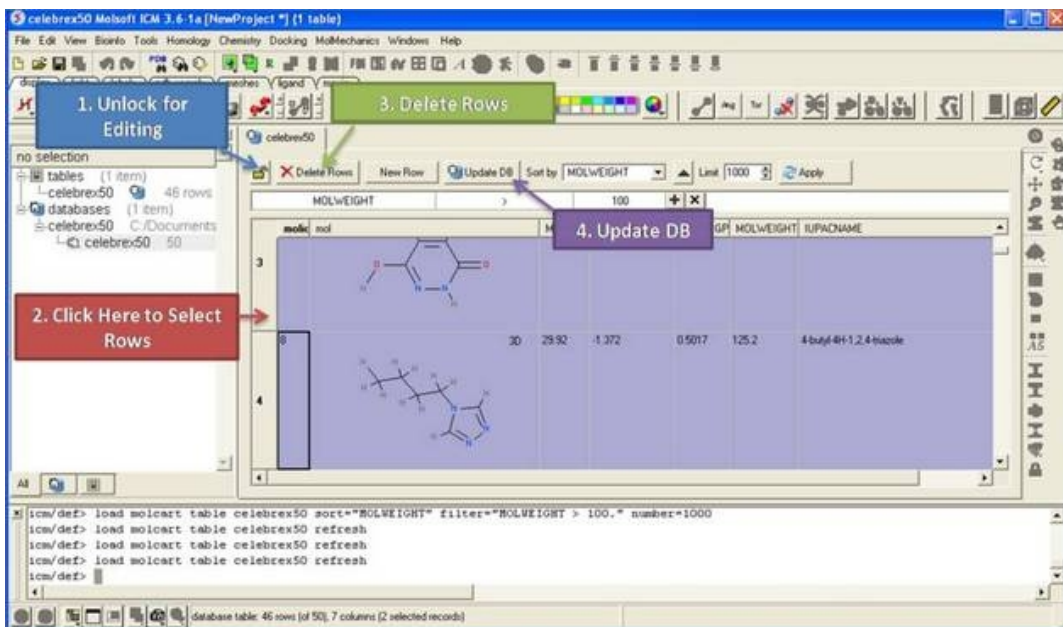

### To insert a new row

- Select a row.
- Click on the **New Row** button. A new row will be inserted underneath the selected row.
- Click **Update DB**

### To edit strings and numbers in a row

- Double click on the cell you wish to edit and then enter a new value.
- Click **Update DB**

### To edit a chemical (2D sketch):

- Right click on the cell and select **Edit Molecule**
- Make changes using the Molecular Editor
- Click **Update DB**

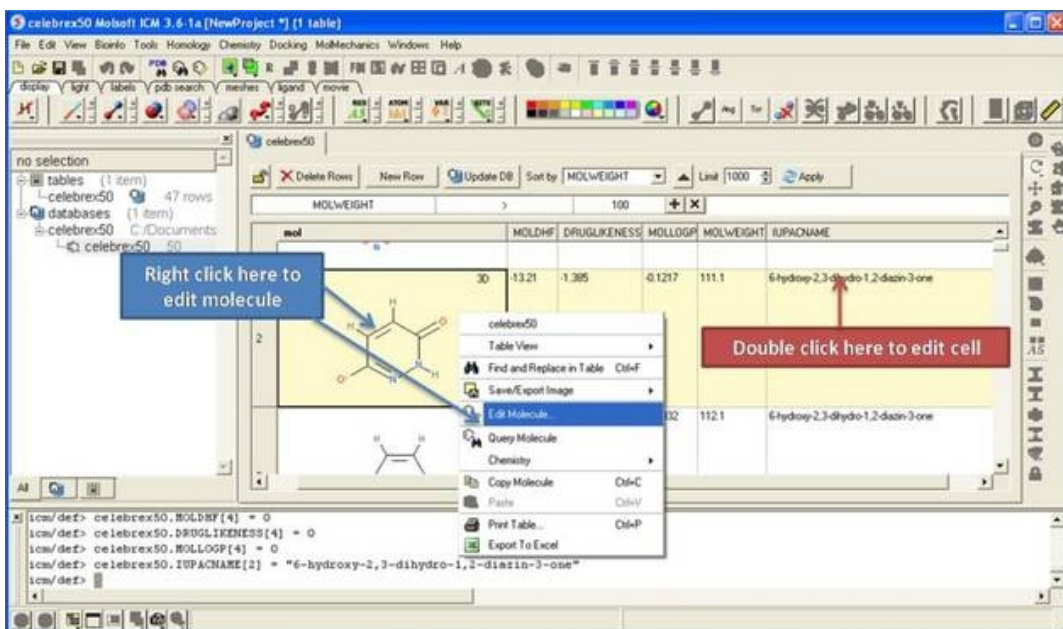

## 15.4 Query Local Database

To query a local database:

- Right click on the database in the ICM Workspace and select **Query**.
- Query using the chemical search tools.

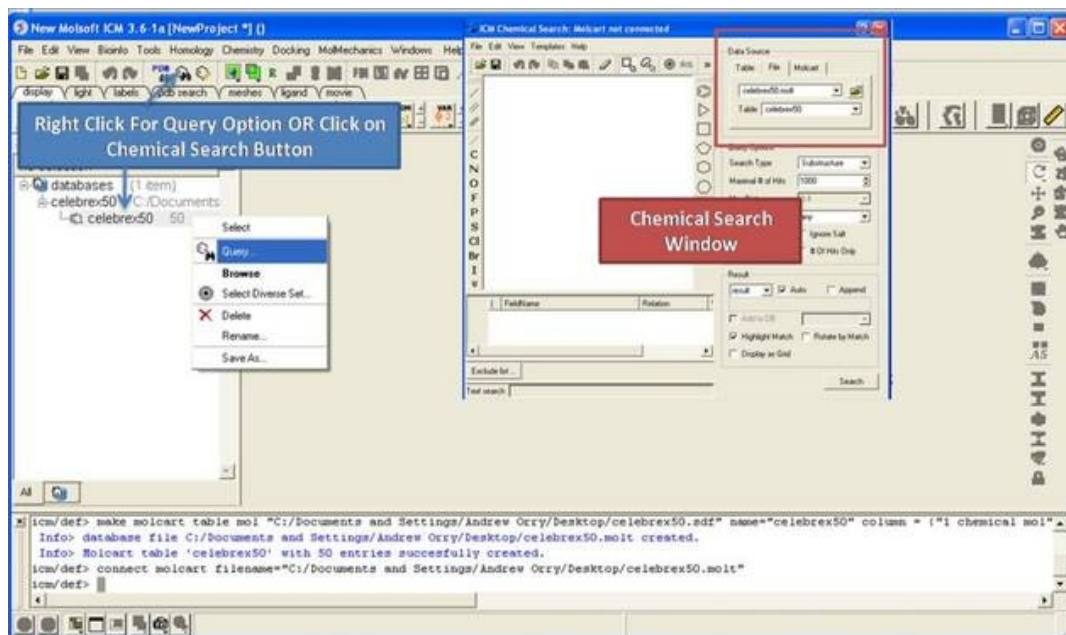







# 16 Tutorials

**Note:** Click **Next** (top right hand corner) to navigate through this chapter. Headings are listed on the left hand side (web version) or by clicking the **Contents** button on the left-hand-side of the help window in the graphical user interface.



## 16.1 Graphical Display Tutorial: Molecule Representation, Coloring, Labeling and Annotation

### 16.1.1 Change Molecule Representation and Color

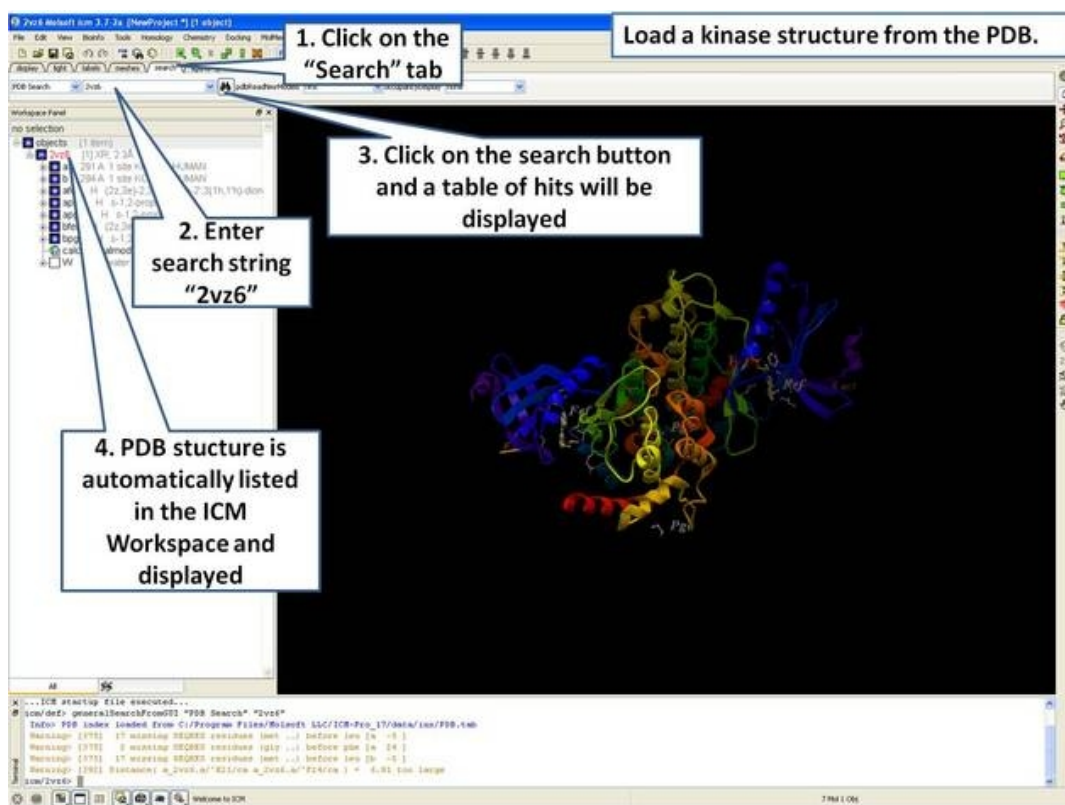

The screenshot shows the ICM software interface with the following callouts:

1. Click on the "Search" tab
2. Enter search string "2vz6"
3. Click on the search button and a table of hits will be displayed
4. PDB structure is automatically listed in the ICM Workspace and displayed

Additional callouts include: "Load a kinase structure from the PDB." and "no selection". The interface shows a search results table with columns for PDB ID, Name, and Date. The search results table is as follows:

PDB ID	Name	Date
2vz6	2vz6	2008-09-11
2vz7	2vz7	2008-09-11
2vz8	2vz8	2008-09-11
2vz9	2vz9	2008-09-11
2vza	2vza	2008-09-11
2vzb	2vzb	2008-09-11
2vzc	2vzc	2008-09-11
2vzd	2vzd	2008-09-11
2vze	2vze	2008-09-11
2vzf	2vzf	2008-09-11
2vzg	2vzg	2008-09-11
2vzh	2vzh	2008-09-11
2vzi	2vzi	2008-09-11
2vzj	2vzj	2008-09-11
2vzk	2vzk	2008-09-11
2vzl	2vzl	2008-09-11
2vzm	2vzm	2008-09-11
2vzn	2vzn	2008-09-11
2vzo	2vzo	2008-09-11
2vzp	2vzp	2008-09-11
2vzq	2vzq	2008-09-11
2vzr	2vzr	2008-09-11
2vzs	2vzs	2008-09-11
2vzt	2vzt	2008-09-11
2vzu	2vzu	2008-09-11
2vzv	2vzv	2008-09-11
2vzw	2vzw	2008-09-11
2vzx	2vzx	2008-09-11
2vzy	2vzy	2008-09-11
2vzz	2vzz	2008-09-11

The interface also shows a 3D molecular model of a kinase structure, a workspace panel with a tree view, and a command window at the bottom with the following text:

```
...ICM startup file executed...
icm/de> generalSearchFromPDB "PDB Search" "2vz6"
Info: PDB index loaded from C:\Program Files\Biosolve\ICM\ICM-17\data\bin/PDB.tbl
Message: [575] IT waiting 00:00:00 execution time ... before run [n: 0]
Message: [576] IT waiting 00:00:00 execution time ... before run [n: 24]
Message: [577] IT waiting 00:00:00 execution time ... before run [n: 48]
Message: [578] Statement: a_2vz6.n*2270w_a_2vz6.n*P2470w 1 = 4.91 size large
load2vz6
```

PyMol Main [v1.7.7.3] (NewProject) [1 object]

File Edit View Build Tools Helplog Chemistry Editing Help/Manuals Windows Help

1. Right click here

Change the background color.

The screenshot shows the PyMol interface with a protein structure rendered in a multi-colored ribbon representation. A callout box labeled "1. Right click here" points to the background color selection tool in the top toolbar. Another callout box labeled "Change the background color." points to the same tool. The left sidebar shows a list of objects including 'a', 'b', 'afaf', 'apgo', 'apgo2', 'afaf', 'apgo', and 'W'. The bottom console shows the command 'color background rgb=(155,155,155)'.

PyMol Main [v1.7.7.3] (NewProject) [1 object]

File Edit View Build Tools Helplog Chemistry Editing Help/Manuals Windows Help

1. Click in the boxes to display and undisplay

2. Use these buttons to rotate molecule

Display the "a" subunit and ligand.,

The screenshot shows the PyMol interface with the protein structure rendered in a multi-colored ribbon representation. A callout box labeled "1. Click in the boxes to display and undisplay" points to the checkboxes for subunits 'a' and 'b' in the left sidebar. Another callout box labeled "2. Use these buttons to rotate molecule" points to the rotation controls in the top toolbar. A third callout box labeled "Display the 'a' subunit and ligand.," points to the 'a' subunit in the sidebar. The bottom console shows commands for displaying and undisplaying subunits and for rotating the molecule.

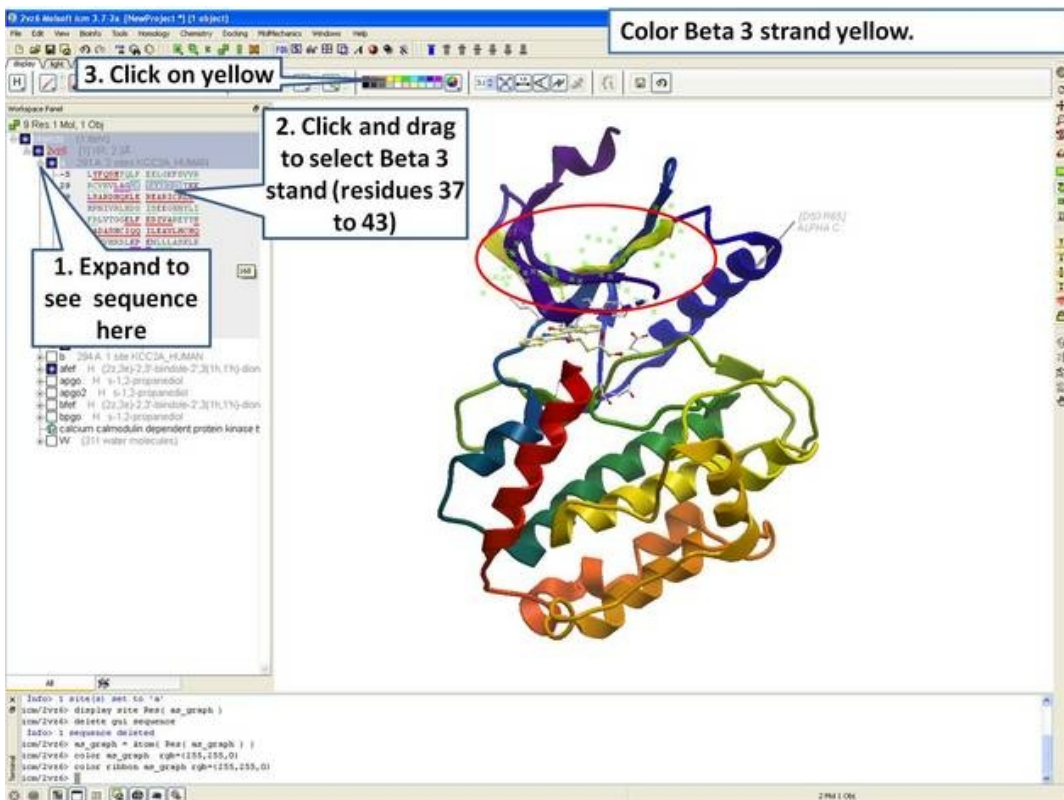
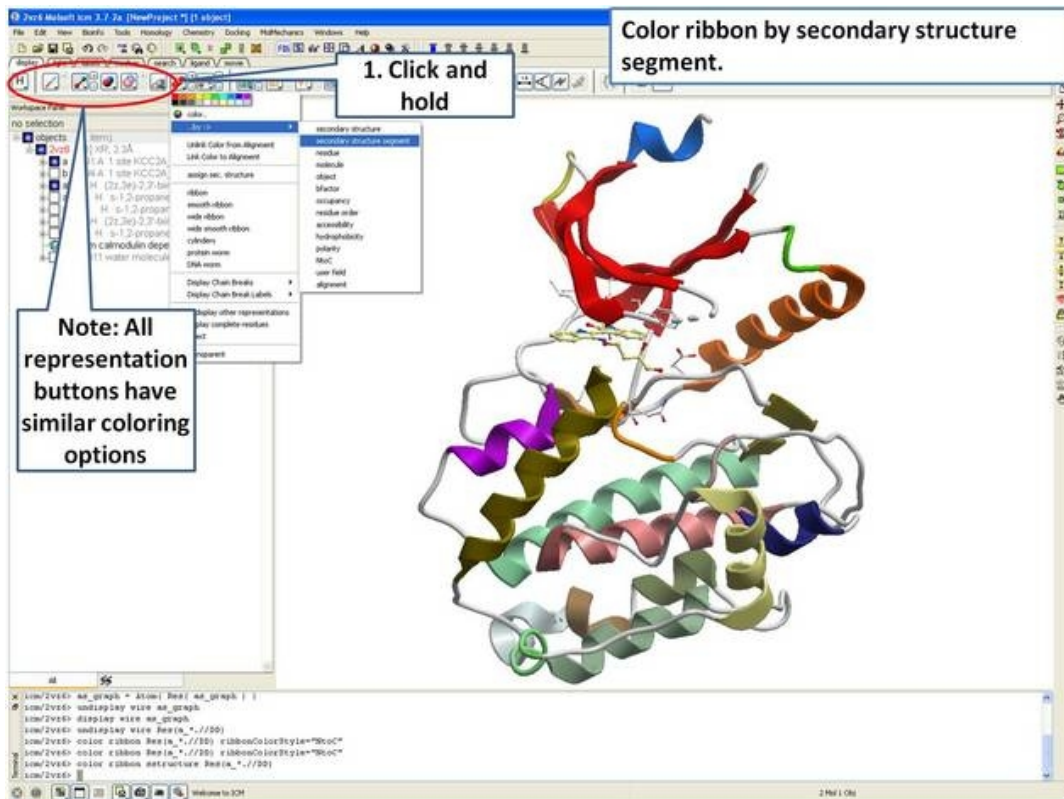

## 16.1.2 Annotation

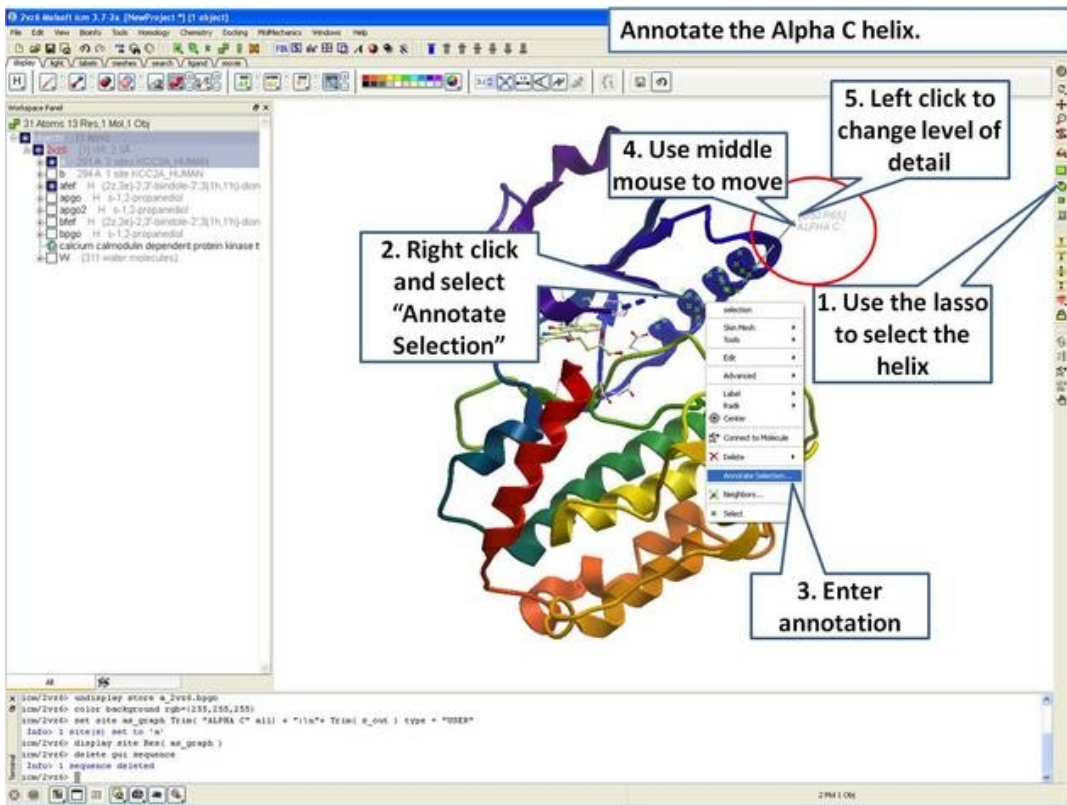

### 16.1.3 Labels

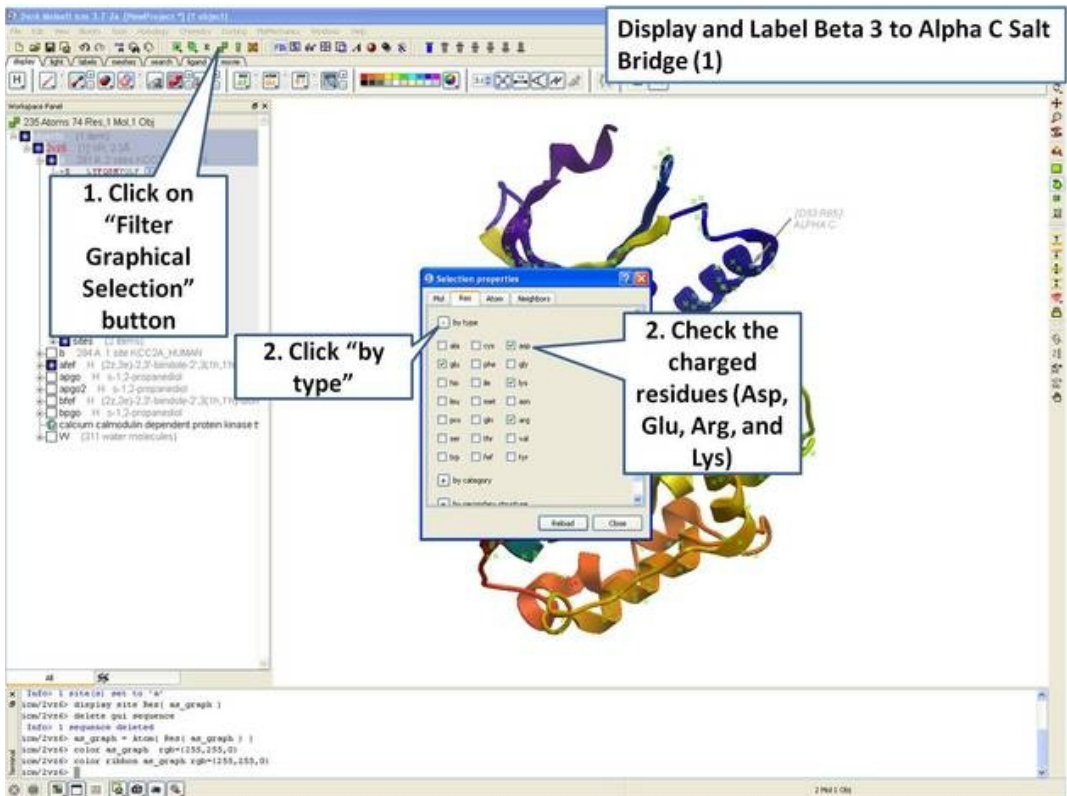

PyMOL v2.5.0 (64-bit) [NewProject] (1 object)

1. Click here to propagate selection to all atoms in residue

2. Click here to display all charged residues in wire

Display and Label Beta 3 to Alpha C Salt Bridge (2)

74 Res 1.0

3b5a (2 dom)

B 3b5a 1 sbe HCCCA\_HUMAN

afef H (2z,3e)-2,3-bisphosphate-2,3(OH,1H)-dion

apgo H s-1,2-propanediol

apgo2 H s-1,2-propanediol

afef H (2z,3e)-2,3-bisphosphate-2,3(OH,1H)-dion

apgo H s-1,2-propanediol

calcium calmodulin dependent protein kinase t

W (311 water molecules)

at 56

```

x sim/2v6@ delete gui sequence
i into 1 sequence delete
sim/2v6@ aa_graph = atom Res| aa_graph |
sim/2v6@ color aa_graph rgb=155,155,0)
sim/2v6@ color ribbon aa_graph rgb=155,155,0)
sim/2v6@ aa_graph = atom Res| aa_graph |
sim/2v6@ display wire aa_graph
sim/2v6@

```

2 PM 1.0s

PyMOL v2.5.0 (64-bit) [NewProject] (1 object)

1. Undisplay all xstick representations for clarity

2. Use the zoom in button to locate alpha C to beta 3 salt bridge

3. Click on the residue label button

4. Click on each residue to label

5. Click and hold on the residue label button for label coloring and style options

Display and Label Beta 3 to Alpha C Salt Bridge (3)

no selection

3b5a (2 dom)

B 3b5a 1 sbe HCCCA\_HUMAN

afef H (2z,3e)-2,3-bisphosphate-2,3(OH,1H)-dion

apgo H s-1,2-propanediol

apgo2 H s-1,2-propanediol

afef H (2z,3e)-2,3-bisphosphate-2,3(OH,1H)-dion

apgo H s-1,2-propanediol

calcium calmodulin dependent protein kinase t

W (311 water molecules)

at 56

```

x sim/2v6@ color aa_graph rgb=155,155,0)
sim/2v6@ color ribbon aa_graph rgb=155,155,0)
sim/2v6@ aa_graph = atom Res| aa_graph |
sim/2v6@ display wire aa_graph
sim/2v6@ color residue label Res|_//380 rgb=10,0,0)
sim/2v6@ center atomic aa_graph
sim/2v6@ undisplay xstick Res|_//380)
sim/2v6@

```

2 PM 1.0s

4. Propagate selection to all atoms

1. Undisplay wire and other label annotations from previous examples

2. Right click on the "a" subunit ligand and choose "Select Neighbors"

3. Enter the parameters as shown

Display and label the residues near the ligand binding pocket (1).

1. Select xstick

2. Select residue labels

Display and label the residues near the ligand binding pocket (2).

16.1.4 2D and 3D Labels



**Create and display a 2D label.**

1. Select the labels tab

2. Select the 2D label button

3. Add text and format

Calcium Calmodulin Dependent Protein Kinase

New Label  
Calcium Calmodulin Dependent Protein Kinase  
Color: [Color palette] More  
Font: serif  
Family: [dropdown]  
Size: 20  
 Bold  
OK Cancel

```

x (icm/2vr60 GRAPHICS.selectSelectionMode = "select"
icm/2vr60 ma_graph = Atom Res( ma_graph | )
icm/2vr60 display name ma_graph
icm/2vr60 ma_graph = n_*/332
icm/2vr60 display name ma_graph
icm/2vr60 display label ma_graph
icm/2vr60 display label "Calcium Calmodulin Dependent Protein Kinase" size*20 font*"serif" bold rgb*(120,0,1)
icm/2vr60

```

**How to edit, delete and move a 2D label.**

Right click here to edit or delete

Click here with middle mouse button to move

Calcium Calmodulin Dependent Protein Kinase

label: Calcium  
[Edit] [Delete]

Move Label  
Calcium Calmodulin Dependent Protein Kinase  
Color: [Color palette] More  
Font: serif  
Family: [dropdown]  
Size: 20  
 Bold  
OK Cancel

```

x (icm/2vr60 GRAPHICS.selectSelectionMode = "select"
icm/2vr60 ma_graph = Atom Res( ma_graph | )
icm/2vr60 display name ma_graph
icm/2vr60 ma_graph = n_*/332
icm/2vr60 display name ma_graph
icm/2vr60 display label ma_graph
icm/2vr60 display label "Calcium Calmodulin Dependent Protein Kinase" size*20 font*"serif" bold rgb*(120,0,1)
icm/2vr60

```

**Create and display a 3D label. A 3D label will move with the object when rotated or translated.**

**1. Select the labels tab**

**2. Select the 3D label button**

**3. Add text and format**

Calcium Calmodulin Dependent Protein Kinase

PDB Code 2VZ6

New Label

PDB Code 2VZ6

Color: red

Font: arial

Size: 40

Bold

Connect to 3D Mesh

Label will be placed at the graphically selected atoms. It updates if and press ESC.

OK Cancel

**How to move, edit and delete a 3D label.**

**1. A 3D label object is created**

**2. Right click for options**

**Connect to 3D Mesh will enable you to move the 3D label. Press "escape" button to disconnect**

Calcium Calmodulin Dependent Protein Kinase

PDB Code 2VZ6

Context Menu:

- Connect to 3D Mesh
- Resize/Move/Hide...
- Edit Label
- Copy
- Copy and Paste
- Copy and Paste...
- Select
- Copy Ctrl+C
- Paste Ctrl+V
- Clone
- Delete
- Rename... F2
- Save As...

## 16.2 Graphical Selections Tutorial

All buttons relating to graphical selections are shaded green. These buttons are shown here and are located at the top of the graphical user interface and along the side.

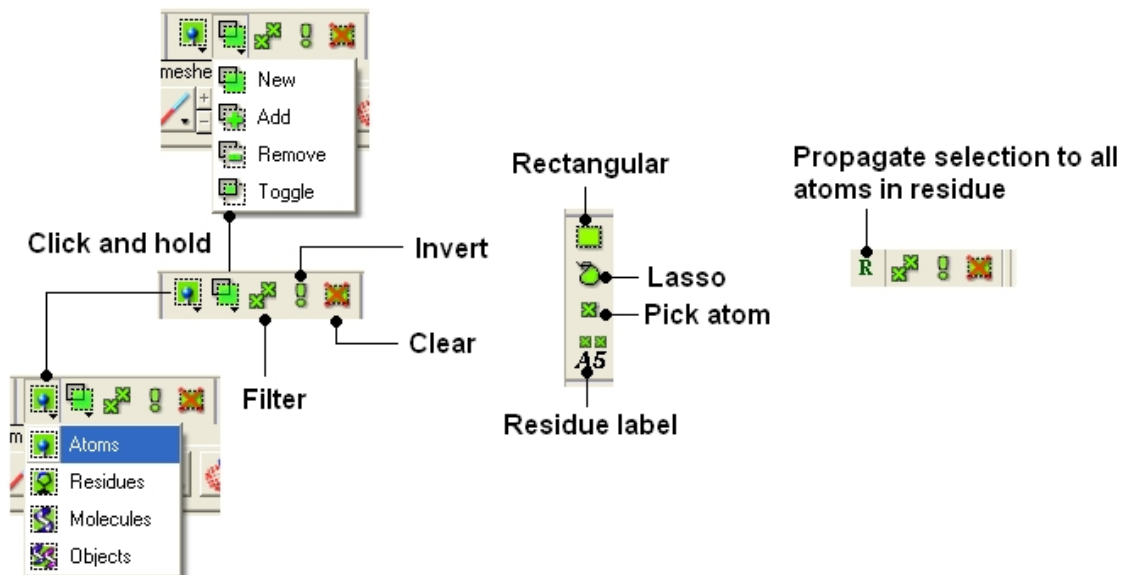

The **File/New window** is a great place to start learning how to use ICM as it provides a quick and easy way to generate new peptides, compounds, DNA/RNA, sequences and graphical objects.

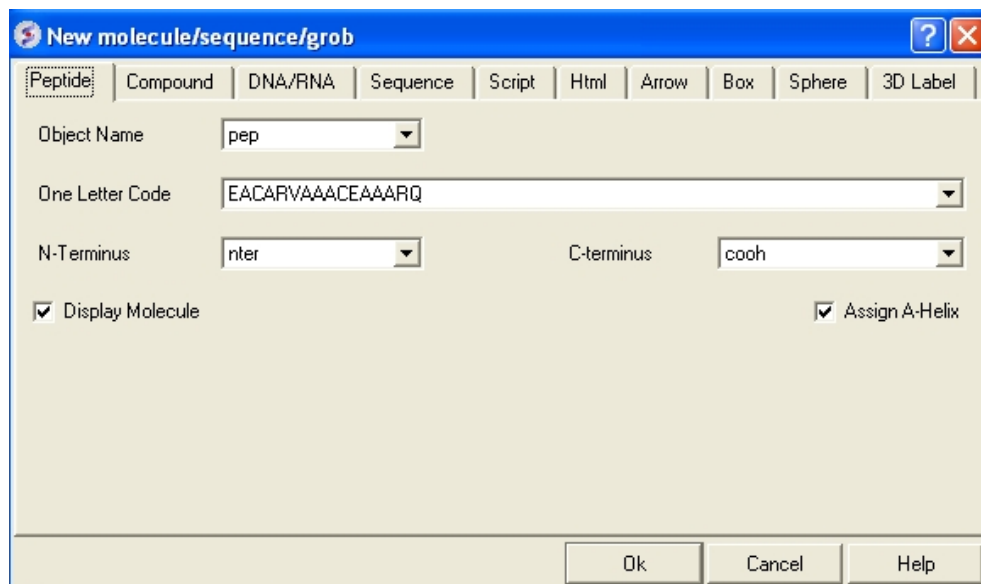

The examples in this section will take you through the basics of making selections in the graphical user interface using objects generated from File/new.

### 16.2.1 Making Basic Selections

- File/New – Select Peptide Tab and use the default peptide entries and select OK. A peptide as shown below will be displayed in ribbon format and the cysteine side-chains in xstick.

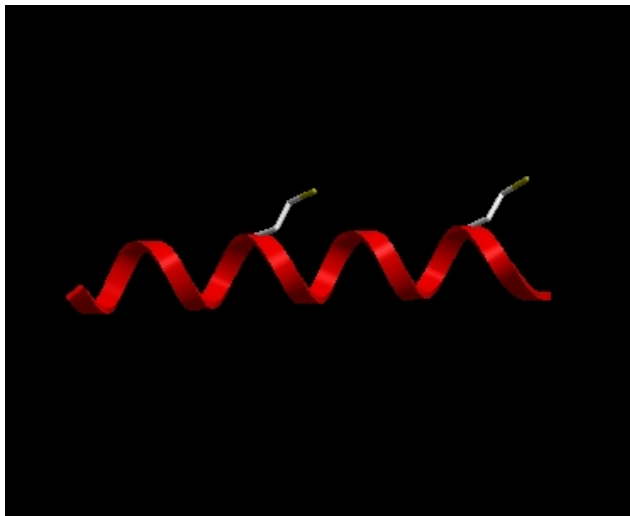

*Now let us display the peptide in wire format and remove the ribbon and xstick representation*

To do this:

- Select the whole object by double clicking on the name of the object "pep" in the ICM Workspace. When selected it will be highlighted in blue in the ICM Workspace and green crosses in the graphical display.

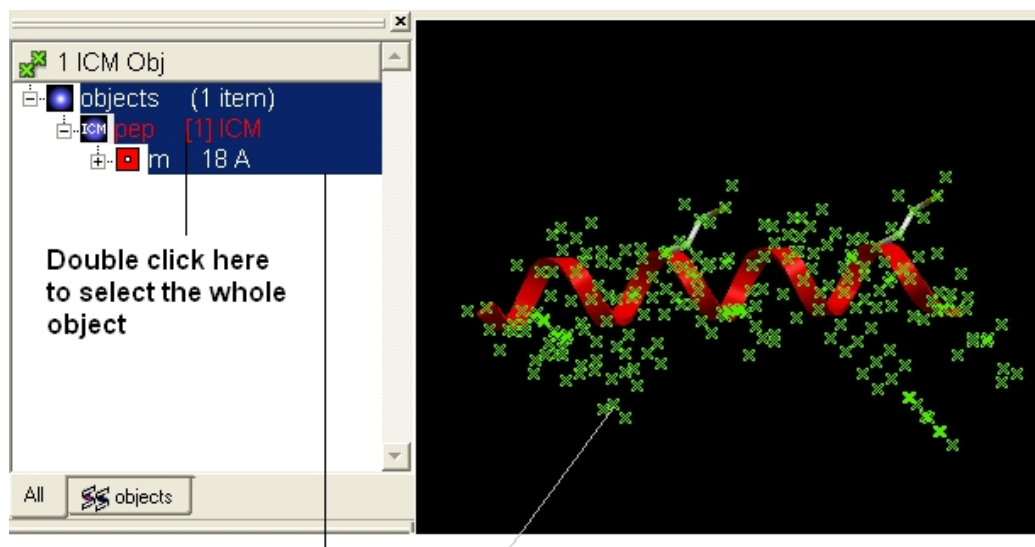

**Selected regions will be highlighted blue in the ICM Workspace and as green crosses in the graphical display**

- Select the "Display Tab" and select the wire button to display wire representation. Select the ribbon button and xstick button to undisplay ribbon and xstick.

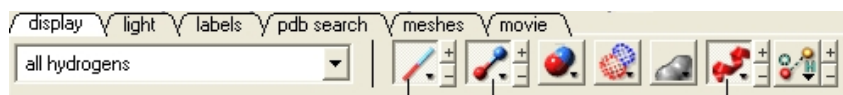

**Click here to display wire**

**Click here to undisplay ribbon**

**Click here to undisplay xstick**

- Your peptide will still be selected. See below on how to remove selections.

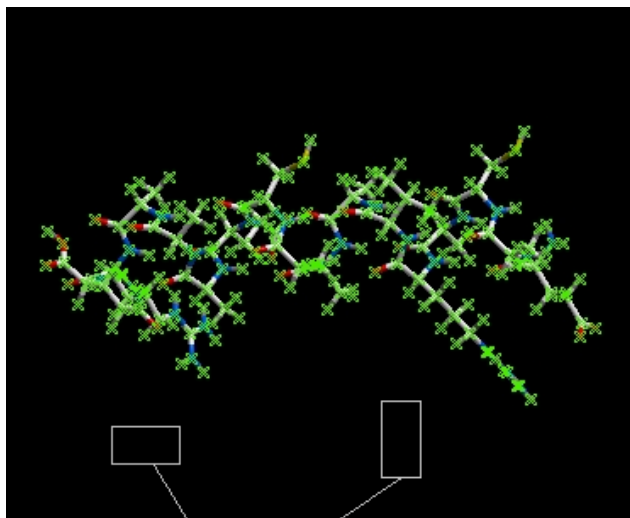

Right click and drag in any blank space to remove the selection (green crosses).

OR

Use the unselect button

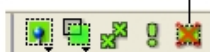

OR

Click in white space in the ICM Workspace

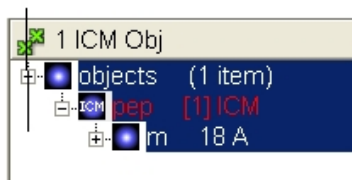

*Now we will display different parts of the peptide in different representations.*

- Right click and drag over a region of the peptide you would like to change.

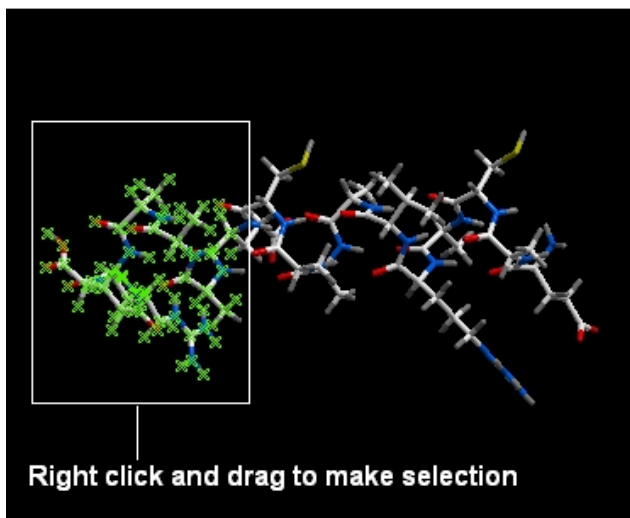

- Use the display panel to select the representation you would like to display.

**Display Tab**

Use the display tab to change representations. The display buttons only respond to a selected region.

*Other ways of making selections.*

**Rectangular Selection**

Select button and use left mouse button to make graphical selection

**Lasso Selection**

Left click and drag

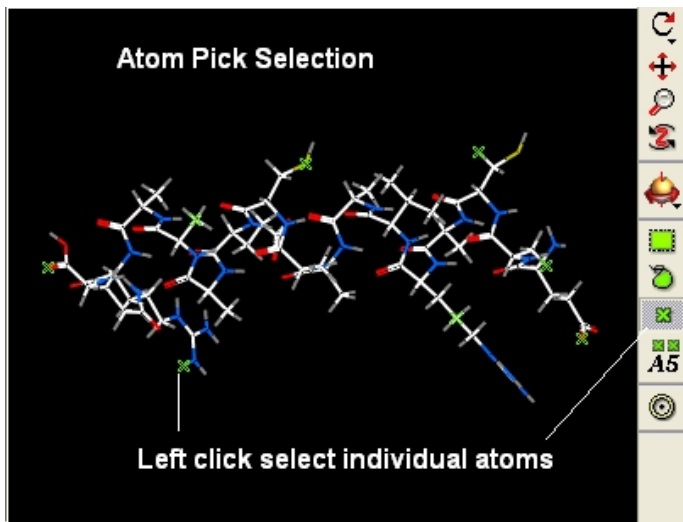

## 16.2.2 Making Sequence Selections in the ICM Workspace

- File/New – Select Peptide Tab and use the default peptide entries and select OK. A peptide as shown below will be displayed in ribbon format.

Selections can be made on the sequence of the peptide. This can be done by expanding the sequence display in the ICM Workspace and clicking and dragging on the sequence as shown below. Non-contiguous selections can be made by clicking/dragging over the sequence whilst holding down the Ctrl key.

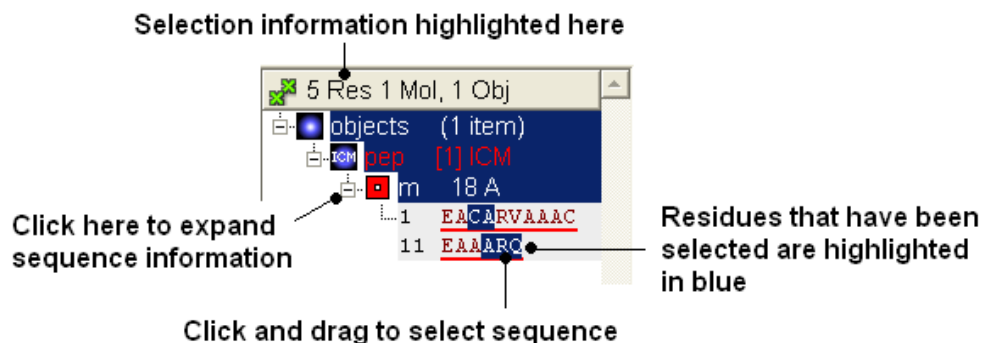

## 16.2.3 Making a Spherical Selection.

In this example we will select the residues surrounding a ligand.

- PDB Search tab (PDB code **1MVC**)
- Right click on the ligand **bm6** in the ICM Workspace.
- Select the **Neighbors** option

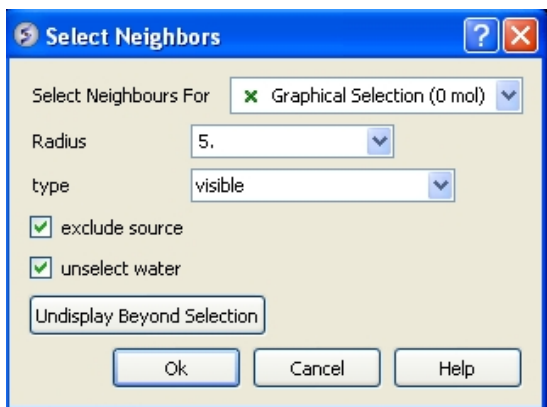

- In the "Select Neighbors For" box leave as Graphical Selection (1 mol)
- Enter Radius 5.
- Enter type **same\_object\_other\_chains**
- Choose **exclude source** and **unselect water**.
- You will see green crosses surrounding the ligand binding pocket.

## 16.2.4 Filtering a Selection.

In this example we will filter the selection made in the previous example and select only His, Asn, Gln and Pro residues surrounding the ligand.

- Make a spherical selection surrounding the ligand in PDB structure \*1MVC (See earlier example).
- Click on the **Filter graphical selection button**.
- Click on the **Res** tab
- Select His, Asn, Gln and Pro residues.

### Filter selection button

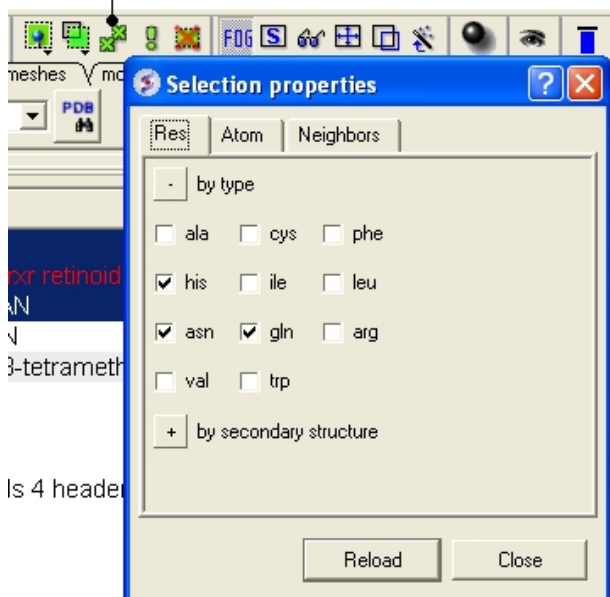

**NOTE:** Only amino acid residues in the current selection will be available in the **Filter**.

**Display the selected residues in wire format.**

- Change the selection from **Atom** to **Residue**.



Click and hold

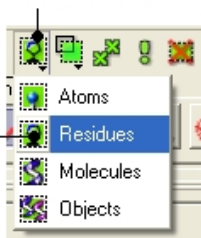

Select residues

- Select the wire representation button in the **display** tab.

### 16.2.5 Propogating a selection to all atoms in a residue.

Sometimes it is useful to propogate a selection to all atoms in a residue. For example when selecting the residues surrounding a ligand within a certain angstrom radius the selection will only pick up certain atoms of a residue. The button shown below can be used to propogate the selection to all atoms in a residue.

Propagate selection to all atoms in residue



## 16.3 Generating Fully Interactive Slides for PowerPoint and the Web Tutorial

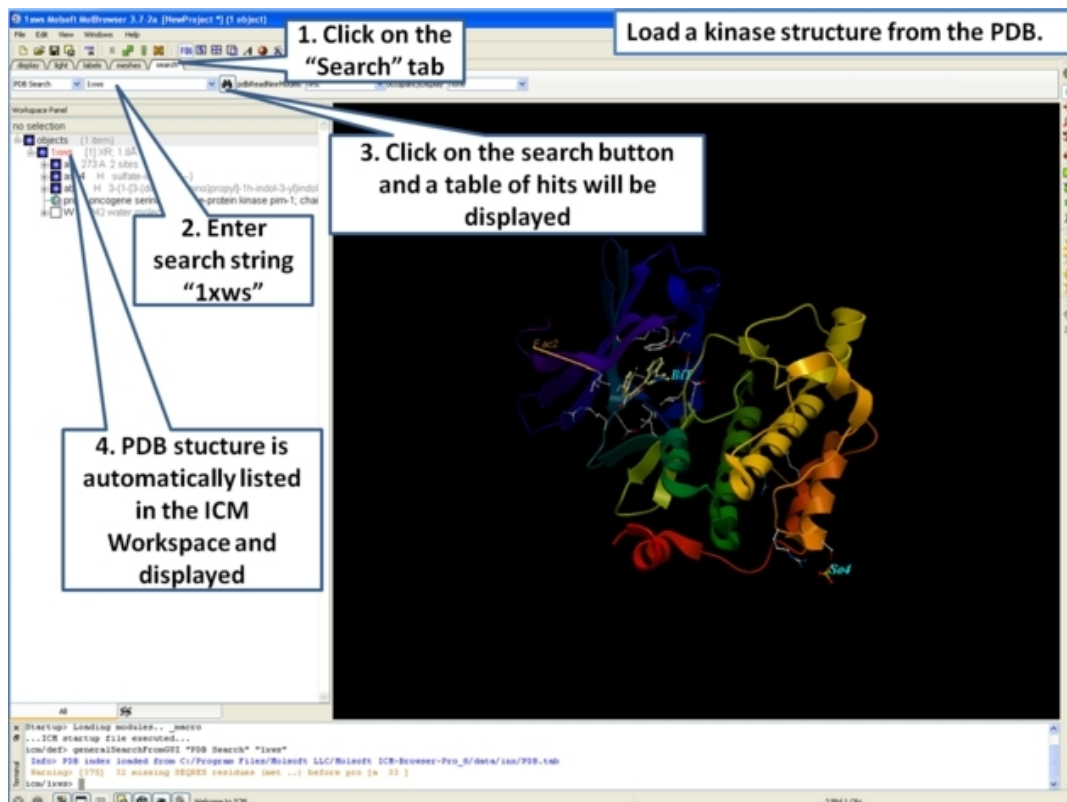

1. Click on the "Search" tab

2. Enter search string "1xws"

3. Click on the search button and a table of hits will be displayed

4. PDB stucture is automatically listed in the ICM Workspace and displayed

Load a kinase structure from the PDB.

Workspace Panel

no selection

objects (1 item)

1	1XWS	1.6A
2	273A	2 sites
3	H	collagen
4	H	3-(1-2)-[G]
5	pr	oncogene serin
6	W	2) water

ICM Workspace

ICM Browser

ICM Browser - Pro\_B/data/uu/PDB.tbl

Search: [175] 32 matching SEQRES residues (met ...) before pro [4 33]

ICM

3 PM 1 CH

Convert the structure from PDB format into an ICM object.

1. Right click here and select "Convert PDB"

2. Enter the options as shown and press OK.

Workspace Panel

- objects (1 item)
- 1 ICM
- 273A 2 sites
- ss04 H 3n
- ss01 H 3-1-[4-dimethylamino]propyl-11-undecyl-3-ylindol
- protb- oncogene serine/threonine-protein kinase pim-1, ch
- VF (342 water)

Convert to ICM

- delete water
- replace the original

OK Cancel

Info: PDB index loaded from C:\Program Files\Bioinformatics\ICM\ICM-Browser-Pro\_8\data\idx\PDB.tbl  
 Message: [1770] 33 atomtype SEDEF coordinate (over ...) before pro [a 33 ]  
 ICM/ ICM=

Prepare the 1<sup>st</sup> slide: Orientate the structure in the graphical display.

1. Use these buttons to rotate and move the structure.

2. Undisplay the sulfate molecule by clicking here

3. Undisplay the default molecule labeling by clicking here

4. Undisplay the default molecule annotations by clicking here

Workspace Panel

- objects (1 item)
- 1 ICM
- 273A 2 sites
- ss04 H 3n
- ss01 H 3-1-[4-dimethylamino]propyl-11-undecyl-3-ylindol
- protb- oncogene serine/threonine-protein kinase pi

Message: [1551] missing heavy atoms! in qis added: m\_connecting\_place\_w/21/0/0g,0l,0e1,0e1,0e1  
 Message: [1552] missing heavy atoms! in acp added: m\_connecting\_place\_w/3250/0b,0g,0l,0e,0l,0e1,0e1,0e1,0e1,0e1,0e1  
 Message: [1553] 2170 missing hydrogen added automatically for residue from ssm.cen  
 Message: [1560] No optimization after conversion to ICM-browser  
 ICM/ ICM= center static no\_graph

Make the 1<sup>st</sup> slide: A view of the first subunit with ligand displayed.

2. Note: Slide is listed in the ICM Workspace

1. Click here to make a slide

Workspace Panel

- slides (1 item)
- slideshow
- Slide 1
- objects (1 item)
- atoms
- 273A 2 sites
- 3504 H 20
- 3501 H 3-1-1-3-dimethylamino-propyl-10
- proto-oncogene serine/threonine-protein kinase pim-1, chr

4437 Atoms 273 Res 276 A 1 C81

Make the 2<sup>nd</sup> slide: Center on the glycine rich loop and color.

1. Click here to expand display to sequence level.

2. Click and drag over glycine rich residues to select them.

3. Click on the center button.

4. Click on the color panel.

5. Click here to add rocking and or rotation.

6. Click here to make a slide

Workspace Panel

- slides
- Slide 1
- Slide 2
- atoms
- 273A 2 sites
- 3504 H 20
- 3501 H 3-1-1-3-dimethylamino-propyl-10
- proto-oncogene serine/threonine-protein kinase pim-1, chr

3164 1 C81

Make the 3<sup>rd</sup> slide: Ligand binding pocket surface colored by property.

1. Display ligand.

2. Right click here and select center.

3. Right click here and select pocket/receptor pocket.

4. Click here to make a slide

Prepare HTML text for the molecular document.

1. File/New.

2. Click on the Html tab.

3. Enter name of document.

4. Click OK

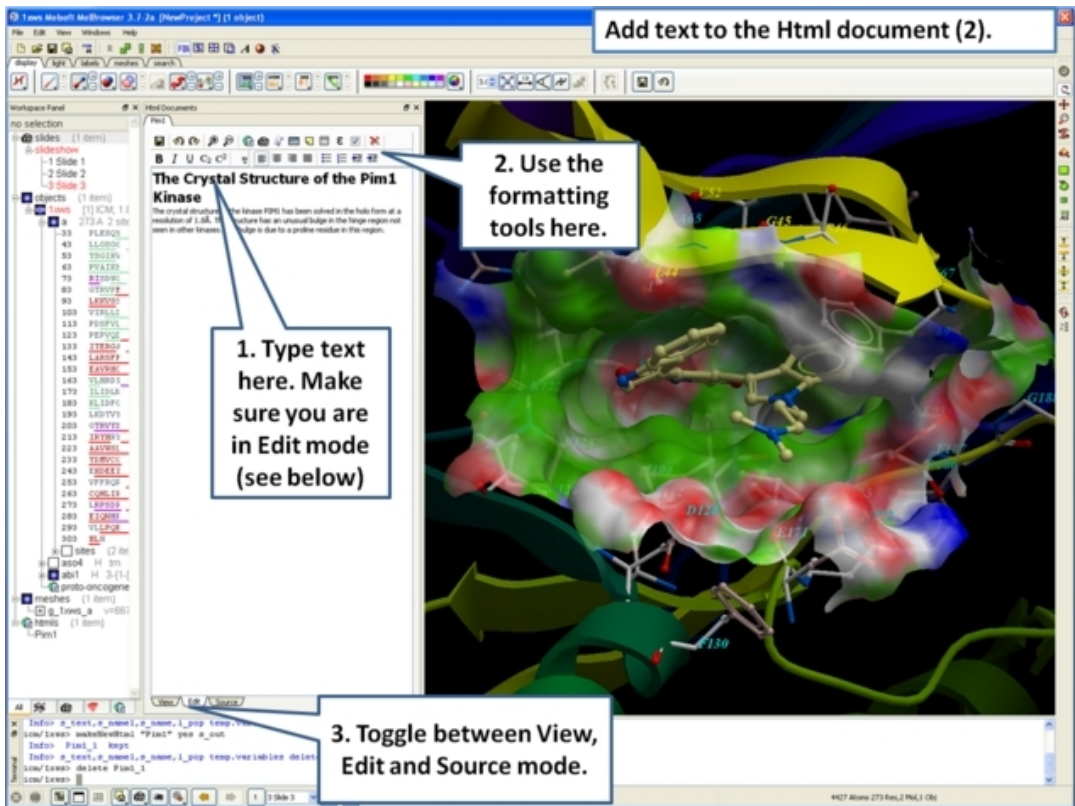
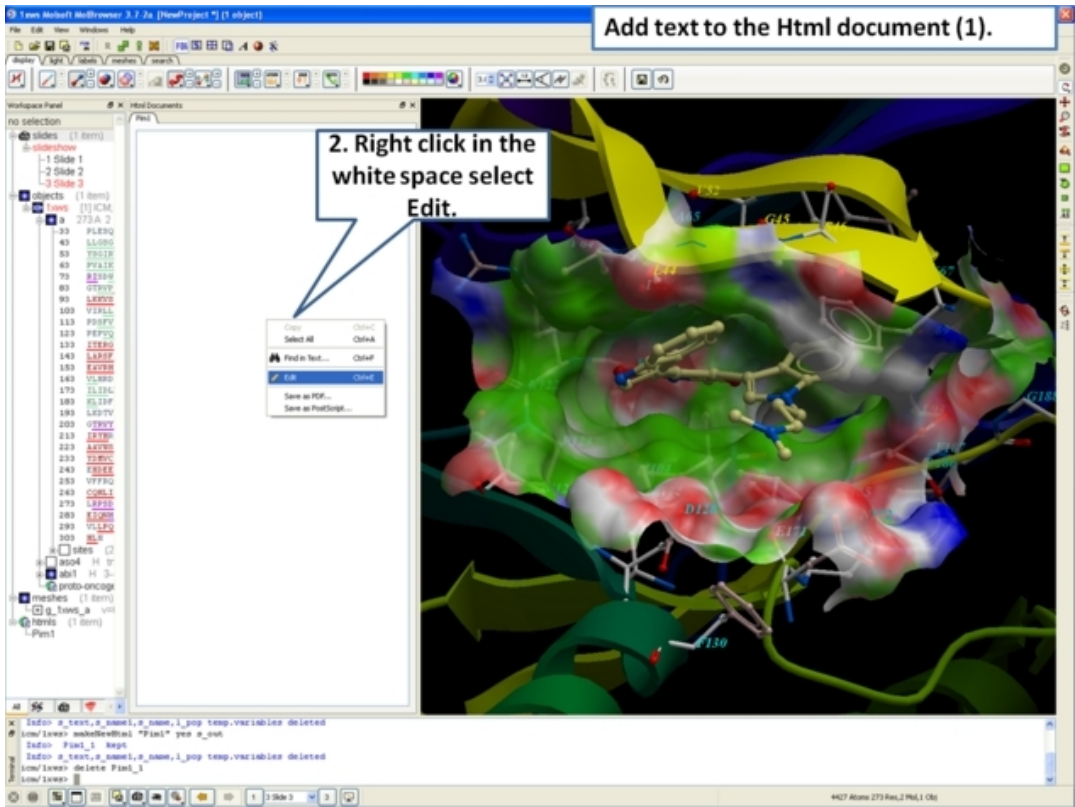

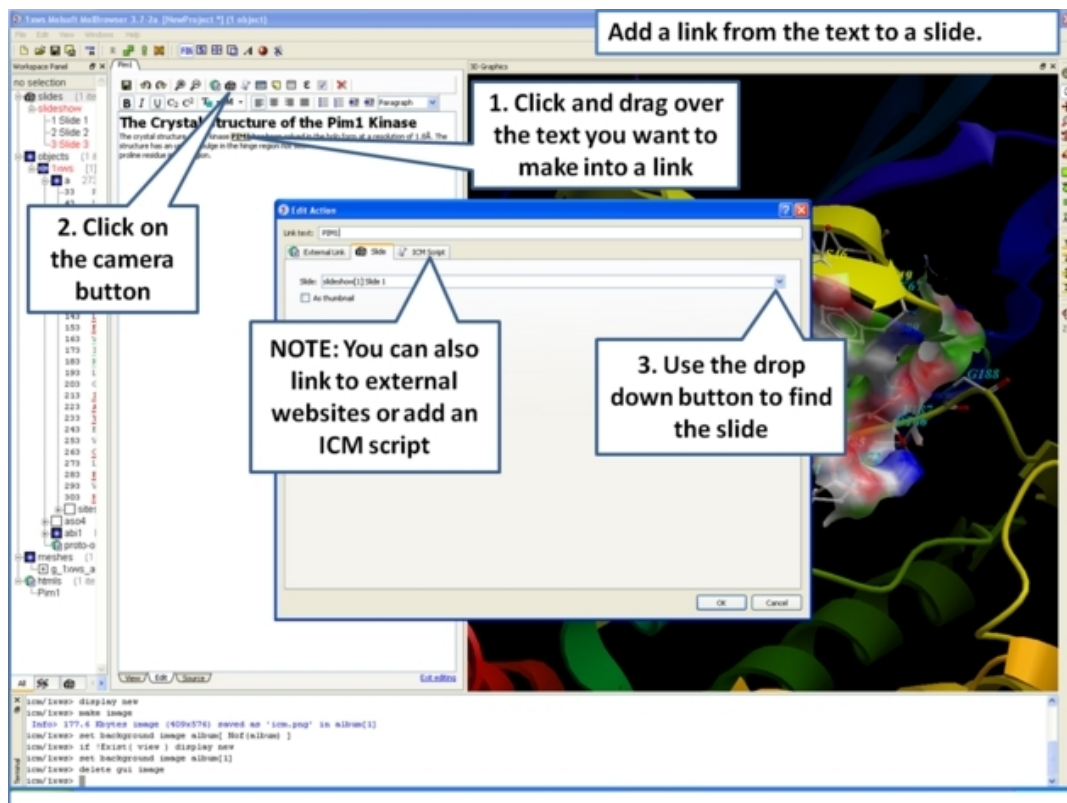

## 16.4 Working with the Molecular Editor

### 16.4.1 Draw Chemical

#### Objective

To sketch the chemical structure of Celebrex a COX-2 inhibitor and save it in an ICM Molecular Table.

#### Background

In ICM it is possible to not only edit structures that you have read into ICM but also create your own and append them to a table, file or a database of structures. All these actions take place in the ICM Molecular Editor.

#### Instructions

- **Chemistry/Molecular Editor** and the editor will automatically be displayed or click on the button shown below.

#### Open ICM Molecular Editor

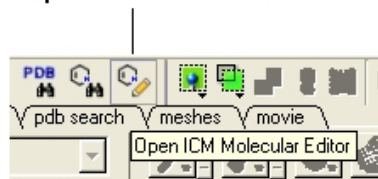

- Draw the Celebrex compound (shown below) within the editor using the rings, atoms and bonds on the left hand side of the editor. Note more advanced options can be found by right clicking on either a bond or an atom.

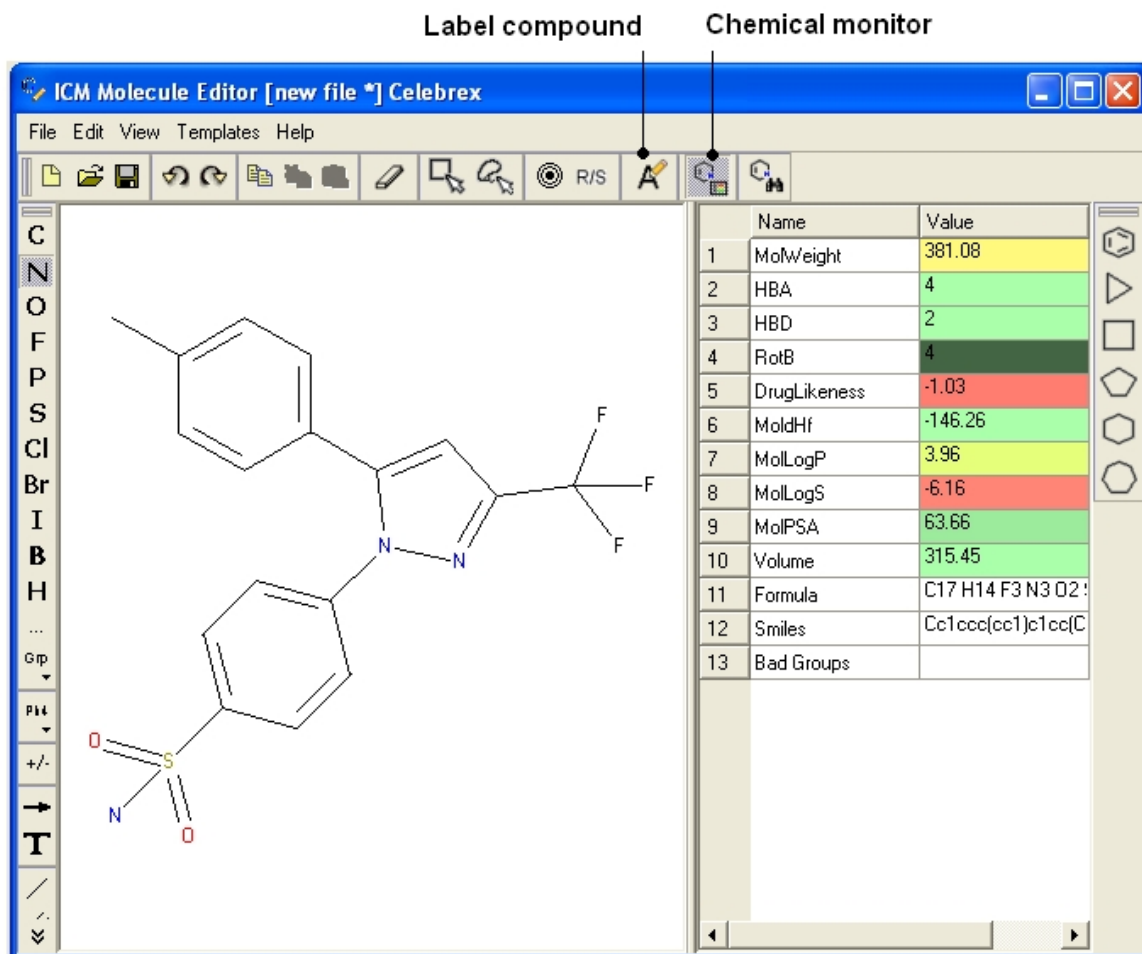

- You can monitor the properties of the molecule whilst drawing it by clicking on the **Chemical Monitor** button.
- Label the compound "Celebrex" (see below)
- Once you have finished drawing you can either save the compound as a separate file, convert to 3D in the graphical display, append it to an already existing compound database in 2D or 3D, or you can save it into a new ICM table.
- In this example we will save it to an ICM table by selecting **File/Append to Table** and then select **New**. Give the table a name such as **Cox Inhibitors**. A molecular table as shown below will be displayed.
- **File/Quit**

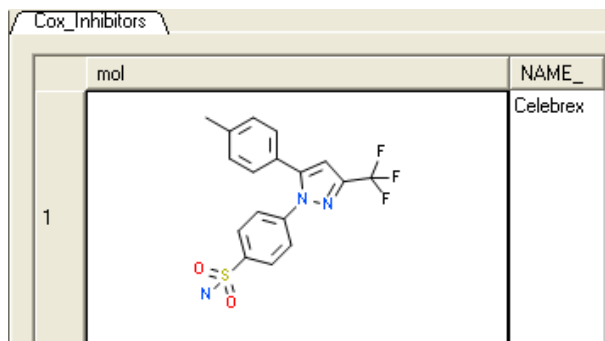

### Manual References (Web Links)

Molecular Editor

## 16.4.2 Edit Chemical

### Objective

To edit the **Celebrex** compound (drawn in the previous example) into a newer COX-2 drug called **Rofecoxib** which maintains the Celebrex backbone but with many changes in functionality.

- To edit the Celebrex compound – right click on the sketch of Celebrex in the Molecular Table and select **Edit molecule**.
- You can submit the changes to the table by clicking on the red cross (close window button) in the molecular editor.
- Alternatively you can append the Rofecoxib molecule to a saved sdf file or save as a separate mol file by using the **File Menu** in the ICM Molecular Editor.
- If you would like to try the chemical search example below append the file to celebrex50.sdf in the distribution

Name	Value
1 MolWeight	314.06
2 HBA	4
3 HBD	0
4 RotB	3
5 DrugLikeness	-0.75
6 MolDHI	83.75
7 MolLogP	2.20
8 MolLogS	-4.96
9 MolPSA	52.29
10 Volume	295.47
11 Formula	C17 H14 O4 S
12 Smiles	CS(c1ccc(cc1)C1CC
13 Bad Groups	

### Manual References (Web Links)

Molecular Editor

## 16.5 Chemical Searching

### 16.5.1 Chemical Similarity Searching

#### Objective

To find the drugs celebrex and rofecoxib in the chemical table **celebrex50.sdf** by performing a substructure chemical similarity search.

#### Background



Using ICM you can perform a compound similarity search whereby a query structure will be searched against a database of compounds. The database can be a compound database already loaded into ICM such as an SDF file or Molsoft's very own compound database called MOLCART.

## Instructions

1. Load the celebex50.sdf file into ICM (File/Open). This file is provided in the ICM distribution.
2. Chemistry/Chemical Search
3. The ICM Molecular Editor and another menu for query search (on the right) will be displayed.
4. If a molecule is already displayed in the editor you can delete it by Edit/Select All to delete
5. We will start by seeing if we can identify celebex and rofecoxib from the common substructure shown below. Draw the substructure query using the Molecular Editor buttons. In this example you will draw a benzene ring with a single bond to a Sulfur atom.

- \* Select the option Local Tables
- \* Select Celebex50 as your database.
- \* Select substructure search
- \* Select the other options as shown in the figure above. You can experiment with different values from the drop down menu.
- \* Select the Search button.
- \* A new table will be constructed called result1 with your substructure search results contained in it. If you added Rofecoxib to the celebex50.sdf in the previous example your results table should contain 2 hits – celebex and rofecoxib.

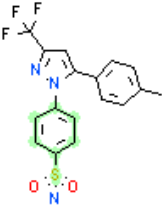
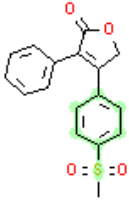
celebrex50		result1
	mol	NAME_
1		
2		

### Notes and Things to Try:

- Note your substructure is highlighted in green in the results table.
- Try using the FP finger print option from the drop down **Search Type** button. A substructure search is a search whereby only the defined molecule in the query will be searched against the database. Whereas, a FP search which stands for fingerprint search enables any fingerprint within a structure to be searched for in the database. The "Max distance" option is available for use with the FP search and the "Matches number" option is for use with the substructure search. The option you do not require based on your search method will be blanked out. A "Max distance" value of 0 means that the search will only identify matches exactly the same as the fingerprint – the default is 0.4. The "Matches number" option allows you to stipulate how many times within a structure in the database your query can be found.

### Manual References (Web Links)

Chemical Substructure/Similarity Searching

## 16.5.2 Advanced Chemical Similarity Searching

### Objective

To use the right click options in the chemical search window to add additional search criteria and find ways to distinguish Celebrex from Rofecoxib.

### Instructions

1. Load the celebrex50.sdf file into ICM (File/Open). This file is provided in the ICM distribution. Add Rofecoxib to the celebrex50.sdf file as described in the chemical-edit tutorial.
2. Chemistry/Chemical Search
3. The ICM Molecular Editor and another menu for query search (on the right) will be displayed.
4. If a molecule is already displayed in the editor you can delete it by Edit/Select All to delete
5. Follow the search instructions described in the previous example with the following chemical search substructures:

Celebrex contains halogen atoms and Rofecoxib does not – therefore one way to distinguish the two would be a simple filter as shown below.

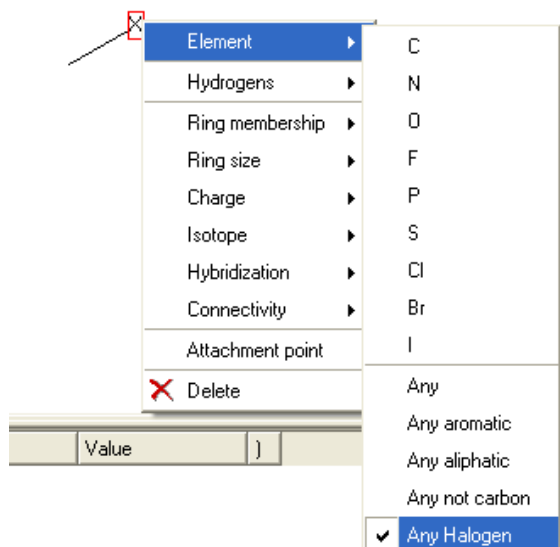

One of the key features between Celebrex and Rofecoxib is a benzene ring connected to a five-membered ring. The difference is that in celebrex the connection point is with a nitrogen atom and in Rofecoxib the connection point is with a carbon atom. Therefore to retrieve both Celebrex and Rofecoxib in the results table you would need to right click and select **Element/Any (\*)** and select **Ring Size 5 (r5)** or to retrieve only one you would need to specify nitrogen or carbon at the connection point.

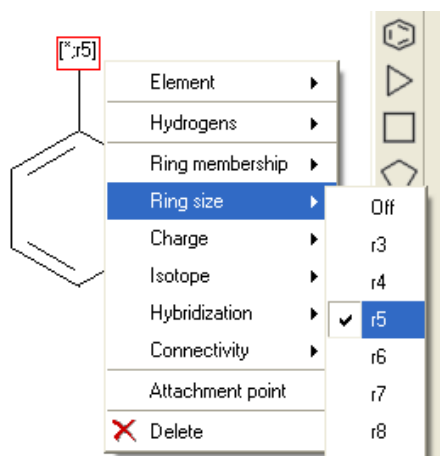

You can also perform the same query using Ring Membership (R1) or Attachment Point.

### Manual References (Web Links)

Chemical Similarity Searching

## 16.5.3 3D Pharmacophore Searching

**Objective** Undertake a 3D pharmacophore search of a table containing 3D coordinates.

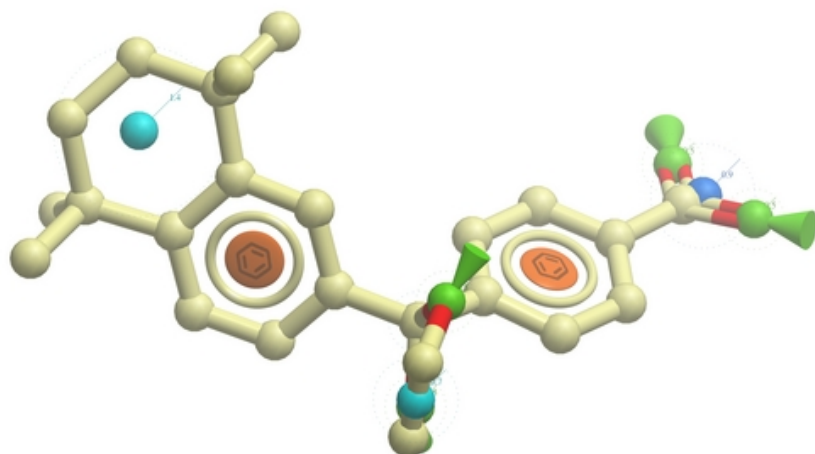

- File/Open **example\_ph4.icb** (this file is provided in the ICM distribution and therefore can be found in \$ICMHOME or in Windows Program Files/MolSoft)
- In this example the 3D pharmacophore has already been extracted from a ligand. To find out how to generate a 3D pharmacophore see the section entitled *Pharmacophore Draw 3D*.
- In this example a table containing 3D coordinates is already provided containing 3D coordinates. The table is called **t\_3D**.
- To run 3D pharmacophore searching right click on the name of the pharmacophore object in the ICM Workspace and select **Search Pharmacophore**.
- Select the table **t\_3D** from the drop down list and click OK.
- A table of search results will be displayed.

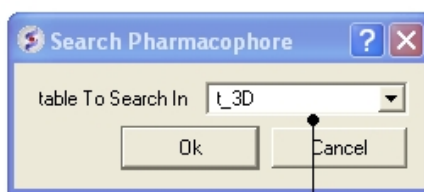
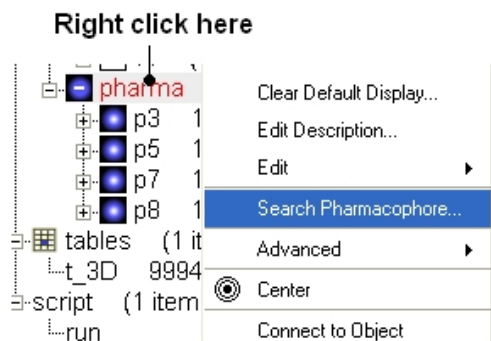

Enter name of table containing 3D coordinates

- You can browse the results by clicking on the table and the ligand will be displayed in the graphical display.
- Remember you can use the check boxes in column L to **lock** compounds and overlay them.

## Browse and lock compound in 3D display

l\_3D | ph4\_res

mol	NAME_	molid	confid	L	rmsd	score
1	chiral.3D->2D	822	189664		0.00469	100
	chiral.3D->2D	824	190184		0.007595	100

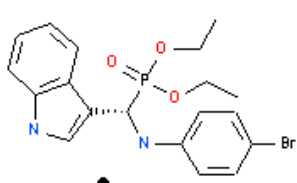

Double click to view in 3D

### Manual References (Web Links)

3D Pharmacophore Search

## 16.5.4 2D Pharmacophore Searching

**Objective** Undertake a 2D pharmacophore search of a chemical spreadsheet.

- File/Open **example\_ph4.icb** (this file is provided in the ICM distribution and therefore can be found in \$ICMHOME or in Windows Program Files/MolSoft)
- Chemistry/Chemical Search
- Draw the query as shown below using the

Distance bond

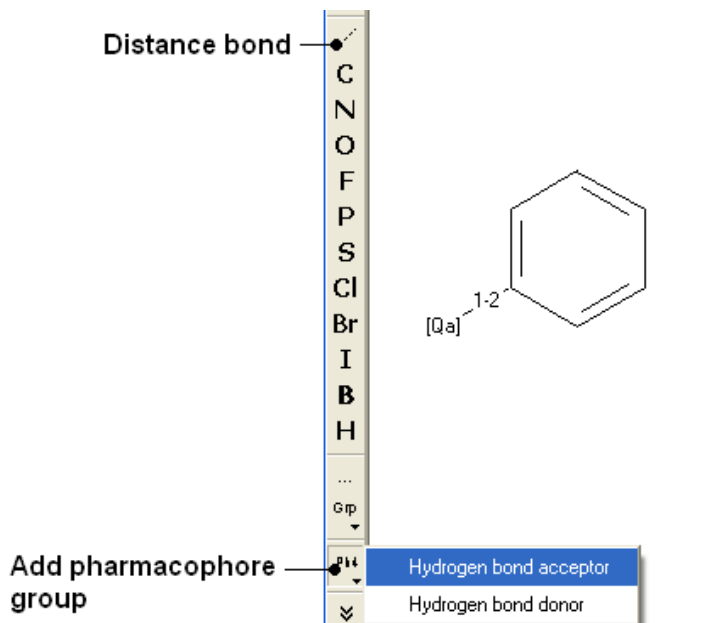

Add pharmacophore group

- Fill in the query and results option as shown below.

The screenshot shows a chemical search interface. On the left, a benzene ring is displayed with a [Qa] label and a 1-2 bond. The right pane is divided into three sections: Data Source, Query Options, and Result. The Data Source section has radio buttons for Local Tables (selected) and MolCart. The Query Options section includes dropdown menus for Database, Table (t\_3D), Search Type (Substructure), Maximal # of Hits (1000), Max Distance (0.4), and Number of Matches (any). There are also checkboxes for Match stereo, Ignore Salt, By Selection, and # Of Hits Only. The Result section has a dropdown for sult\_new, checkboxes for Auto (checked) and Append (unchecked), radio buttons for New Table (selected) and Select in Source, checkboxes for Add to DB, Highlight Match (checked), Rotate by Match, and Display as Grid. A Search button is located at the bottom right of the interface.

## Manual References (Web Links)

2D Pharmacophore Search

# 16.6 How to Generate Plots and Histograms

## 16.6.1 How to make a histogram.

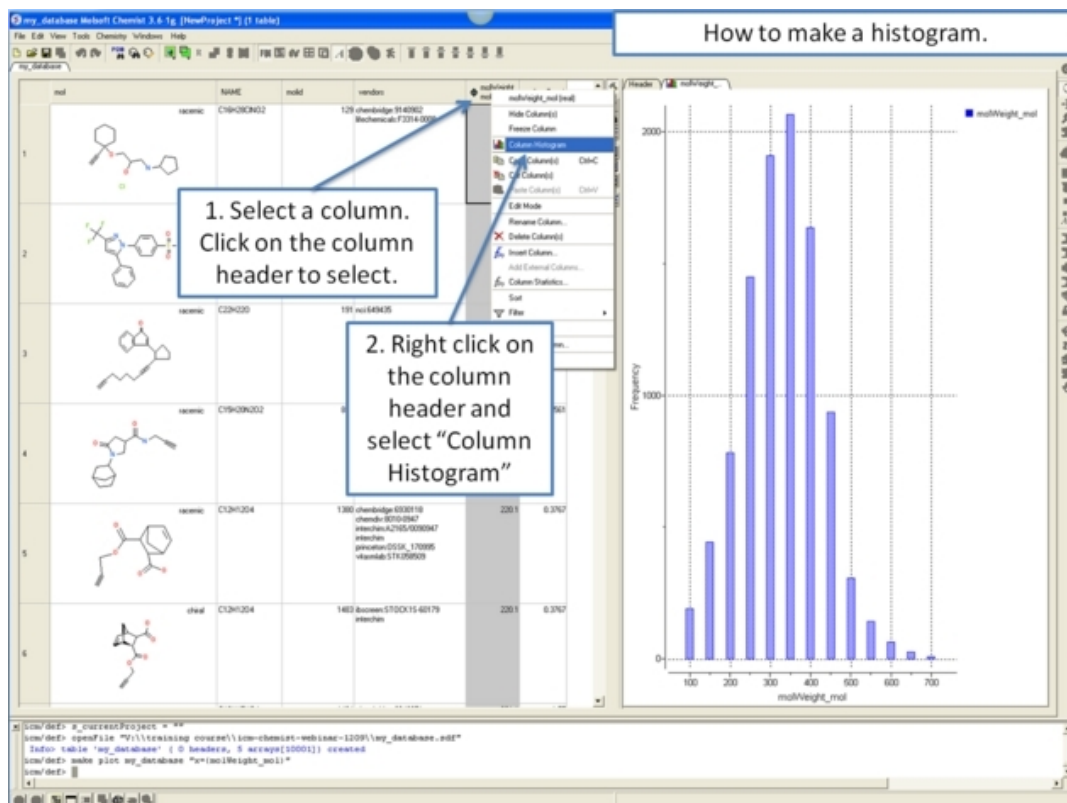

## 16.6.2 How to make an X-Y scatter plot.

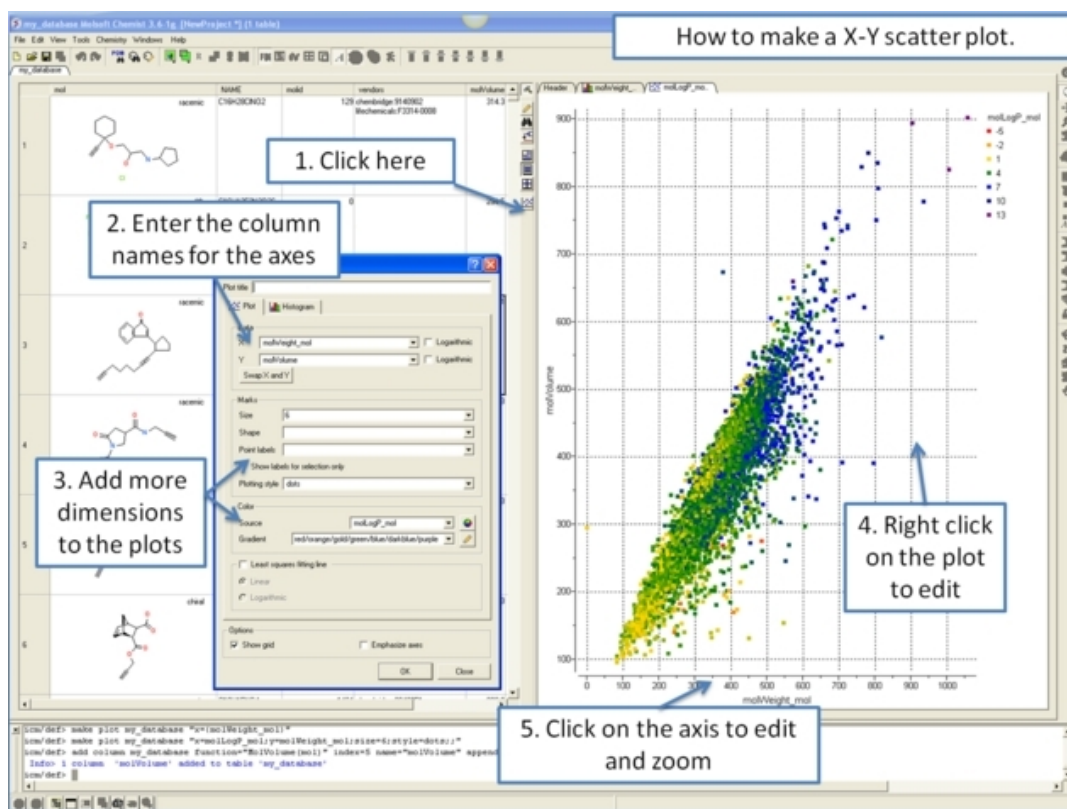





# Index

2D, 125, 234, 235, 293, 294, 295  
to 3D, 294, 295  
depiction, 294  
3D, 125, 234, 235, 237, 294, 387  
object, 114  
predict, 207  
helices strands, 207  
local flexibility, 209  
protein health, 207  
tools identify ligand binding  
pocket, 210  
oda, 209  
ActiveICM, 52  
Atom Single Style, 57  
BlastDB Directory, 55  
alphas, 121  
COLLADA, 50  
CPK, 87, 101  
Clash Threshold, 68  
DNA, 46  
Dock Directory, 55  
Editor, 55  
FILTER.Z, 55  
gz, 55  
uue, 55  
Filter.zip, 55  
GAMESS, 85  
GIF, 53, 173  
GRAPHIC.store Display, 57  
NtoC Rainbow, 60  
alignment Rainbow, 60  
atomLabelShift, 65  
ballStickRatio, 54  
center Follows Clipping, 57  
clash Style, 57  
clashWidth, 57  
clip Grobs, 57  
Skin, 57  
Static, 57  
discrete Rainbow, 60  
displayLineLabels, 65  
displayMapBox, 57  
distance Label Drag, 54  
dnaBallRadius, 67  
dnaRibbonRatio, 67  
dnaRibbonWidth, 67  
dnaRibbonWorm, 67  
dnaStickRadius, 67

dnaWormRadius, 67  
font Scale, 65  
fontColor, 65  
fontLineSpacing, 65  
grobLineWidth, 57  
hbond Ball Period, 54  
Style, 54  
hbondAngleSharpness, 54  
hbondMinStrength, 54  
hbondStyle, 54  
hbondWidth, 54  
hetatmZoom, 54  
hydrogenDisplay, 54  
light, 57  
lightPosition, 57  
mapLineWidth, 57  
occupancy Radius Ratio, 57  
occupancyDisplay, 57  
quality, 57  
rainbow Bar Style, 60  
resLabelDrag, 65  
resize Keep Scale, 57  
ribbonRatio, 67  
ribbonWidth, 67  
ribbonWorm, 67  
rocking, 60  
Range, 60  
Speed, 60  
selectionStyle, 57  
site Label Drag, 65  
Shift, 65  
siteArrow, 65  
stereoMode, 57  
stickRadius, 54  
surfaceDotDensity, 57  
surfaceDotSize, 57  
surfaceProbeRadius, 57  
transparency, 57  
wire Width, 54  
wormRadius, 67  
xstick Backbone Ratio, 54  
Hydrogen Ratio, 54  
Style, 54  
Vw Ratio, 54  
GROB.arrowRadius, 57  
atomSphereRadius, 57  
contourSigmaIncrement, 57

- relArrowHead, 57
- GUI.auto Save, 60
  - Interval, 60
  - max Sequence Length, 60
  - table Row Mark Colors, 60
  - workspace Folder Style, 60
  - workspaceTabStyle, 60
- How To Guide, 91
- Html, 95
- Hydrogen.bond, 61
- ICM Browser How To, 91
  - Pro How To, 163
- IMAGE.bondLength2D, 63
  - color, 63
  - compress, 63
  - gammaCorrection, 63
  - generateAlpha, 63
  - lineWidth, 63
  - lineWidth2D, 63
  - orientation, 63
  - paper Size, 63
  - previewResolution, 63
  - previewer, 63
  - print, 63
  - printerDPI, 63
  - scale, 63
  - stereoAngle, 63
  - stereoBase, 63
  - stereoText, 63
- IUPAC, 259
- Icm Prompt, 68
- Inx Directory, 55
- JPEG, 53
- KMZ, 50
- Log Directory, 55
- LogP, 354
- LogS, 354
- MOL, 215, 218, 219, 234, 235, 341
- MOL2, 218
- MOLT, 365
- MOVIE.frame Grab Mode, 60
- Map Atom Margin, 68
  - Sigma Level, 68
- Markush, 316
  - create, 307
- Max\_Fused\_Rings, 291
- Mnconf, 68
- MolPSA, 291
- MolVol, 291
- Molcart, 270
- MoldHf, 291
- Movie.fade Nof Frames, 60
  - quality, 60
  - Auto, 60
- NMR, 91
- Nof\_Atoms, 291
- Nof\_Chirals, 291
- Nof\_HBA, 291
- Nof\_HBD, 291
- Nof\_Rings, 291
- Nof\_RotBonds, 291
- Output Directory, 55
- PCA, 355, 356
  - analysis, 303
- PDB, 79, 94, 95, 201, 256
  - Directory, 55
    - Style, 55
  - Search, 72
    - Field, 72
    - Homology, 72
    - Identity, 72
    - Sequence, 72
  - convert, 95
  - query, 92
  - search, 91, 92, 93
  - sensitive search, 93
  - similarity, 93
- PFAM, 50
- PLOT.Yratio, 66
  - color, 66
  - date, 66
  - draw Tics, 66
  - font, 66
  - fontSize, 66
  - labelFont, 66
  - lineWidth, 66
  - logo, 66
  - markSize, 66
  - orientation, 66
  - paper Size, 66
  - previewer, 66
  - rainbowStyle, 66
  - seriesLabels, 66
- PLS, 355

Projects Directory, 55  
 Prosite Dat, 55  
     Viewer, 55  
 PubMed, 95  
 QSAR, 354, 355  
 R, 280, 314  
 R-group, 278  
 RMSD, 194  
 Ramachandran Plot, 189  
 Real Format, 68  
     Label Shift, 65  
     Style, 65  
 SAR, 354  
     table, 316  
 SDF, 215, 218, 234, 235, 341  
 SEQUENCE.site Colors, 60  
 SITE.label Style, 65  
     labelOffset, 65  
     wrap Comment, 65  
 SLIDE.ignore Background Color, 60  
     Fog, 60  
 SMILES, 254, 258  
 Select Min Grad, 68  
 Show Res Code In Selection, 65  
 Swissprot, 50  
     Dat, 55  
 Temp Directory, 55  
 Var Label Style, 65  
 Water Radius, 68  
 Wire Style, 54  
 X-ray, 91  
 XPDB Directory, 55  
 Xstick, 87, 101  
 a-bright, 87  
 acceptor, 247  
 acid, 46  
 active, 163  
 activeICM, 163  
 activeicm, 163, 166, 169, 171  
     advanced, 169  
     control, 167  
 activityy, 354  
 add image album, 139  
 adding fragment, 247  
     in editor, 247  
 administration, 287  
 album, 139  
 alias, 247  
 align, 27, 293  
     color 2D scaffold, 293  
 alpha, 87  
     channel, 63  
 ambient, 87  
 amidinium, 294  
 amino, 46  
 analysis, 78  
 angle, 81, 122, 129, 135, 188  
 animate, 75, 132  
     view, 132  
 animation, 141, 142, 143  
     store, 143  
 animations, 141  
 annotate, 293  
     by substructure, 293  
 antialias, 53, 74  
     lines, 76  
     lines, 76  
 append.rows, 84  
 applying prediction models, 355  
 area, 80, 184, 209  
 aromatic, 235  
 arrange, 28  
     window, 28  
 arrow, 48  
 asparagine, 85  
 assign, 105  
     2D coordinates, 294  
     helices, 79, 207  
     strands, 79, 207  
 atom, 61, 235, 381, 385  
 atomLabelStyle, 65  
 attachment, 246, 260  
     point, 310  
 author, 93  
     play slide, 167  
 ave, 356  
 avi, 173, 174  
 axes, 348  
 axis, 347  
     options, 346  
     grid, 346  
     range, 346  
     title, 346  
 b-factor, 80, 209

- image, 119
- backup, 71
- bad, 291
  - groups, 247
- ball, 61
  - and stick, 87, 101
- bank, 91
- basicsel, 31
- best, 241
- binding properties, 111
- bioinfo menu, 78
- biological, 79, 201
- biomolecule, 78, 79, 201
- bond, 97, 248
- bonding, 108
  - preferences, 54
- box, 48, 65, 129
- break, 24
- browse, 237
  - mode, 237
  - molt, 366
  - stack, 85
- build, 142
  - hydrogens, 85
- buttons, 169
- bye, 70
- cache, 171
- calculate properties, 291
- carboxylic acid, 294
- cavities, 183
  - closed, 81, 185
- cell, 79, 200
- center, 77, 132, 134, 337, 373
  - and representative members, 358
- chains, 80
- change selection, 32
  - speed range, 142
- charge, 77, 121, 246, 260
- chem save, 12.5
  - editor, 258
  - image, 258
  - table, 256
  - workspace, 258
- view, 235
- chemical, 215, 235, 237, 241, 248, 280, 284, 294, 296, 310, 317, 356
  - clustering, 300
  - dictionary, 247
  - draw load, 218
  - editor, 242, 247
  - find replace, 278
  - fragments, 240
  - group, 247
  - groups, 247
  - right click, 246
  - search, 259
    - filter, 269
    - text, 271
  - smiles, 218
  - spreadsheet compare, 233
  - spreadsheets, 219
  - structure, 215
  - table display, 219
  - tables, 341
    - append, 248
    - clustering, 300
    - convert, 85
    - draw, 243, 392
    - duplicates, 12.2.18
    - edit, 250, 394
    - editor, 12.5, 256, 258
    - load, 218
    - merge, 303
    - name, 259
    - new, 243
    - properties, 232
    - query, 246, 260, 270
    - read, 218
    - redo, 255
    - save, 248, 12.5, 256, 258
    - search, 246, 259, 260, 270, 394, 396
    - similarity, 246, 259, 260, 270, 394, 396
    - smiles, 218
    - spreadsheet, 219, 12.5, 256, 258
    - structure, 218, 248, 250
    - substructure, 396
    - table, 219, 341, 392, 394
    - undo, 255
  - cheminformatics, 219
  - chemistry, 296
    - convert, 294
    - menu, 291
    - pca, 303
    - smiles, 295
    - duplicates, 304

chi, 122  
 chiral, 298  
 chirality, 298  
 clash, 61, 128  
 classes, 235  
 clear display and planes, 73  
   selection, 32  
   planes, 73  
 click, 27, 132  
 clip, 116, 136  
 clipboard, 137, 359  
 clipping planes, 17, 101  
   tool, 136  
   tools, 136  
 closed cavities, 80, 81, 210  
 cluster, 356  
   representative.center, 301  
 clustering, 356  
 collada, 88, 113  
 color, 79, 117, 118, 121, 207, 241, 293,  
 340, 360  
   background, 119  
   by, 117  
   chemical, 241  
   display mesh, 115  
   table, 235  
   2D sketch, 278  
   background, 76, 119  
   distance, 126  
   mesh, 115  
   table, 235  
 coloring, 118  
 column, 325, 330, 336, 337, 342, 343  
   row width, 330  
   statistics, 334  
   color, 328  
   hide, 225  
   show, 225  
 combinatorial chemistry, 305  
   library, 312  
 combine, 83  
   display style, 67  
 commands, 46  
 compare, 236, 303  
   table, 233  
   tables, 303  
 compatible, 52  
 compound, 296, 341  
   compress, 63  
   conditions, 269  
   connect, 114, 132, 135  
     object, 135  
   connectivity, 246, 260  
   consensus, 80  
   construct, 43, 44, 142  
     DNA, 45  
     RNA, 45  
     chemical, 45  
     compound, 45  
     molecule, 43  
     nucleic, 46  
     object, 43  
     protein, 46  
     sequence, 46  
   contact, 80, 183, 184  
     areas, 80  
   contour, 79, 204, 205  
     map, 79  
   convert, 95, 296  
     chemical, 234  
     local database, 50  
     local.database, 50  
     smiles, 294, 295  
   convert2grid, 79  
   converting pdb, 95  
   copy, 234, 256, 274, 335  
     cell, 335  
     chemical, 234  
     paste row, 335  
       structure, 254  
     row, 335  
     selection to table, 335  
     chemical, 12.2.14  
   cpk, 106  
   crash, 71  
   creat, 153  
   create, 325  
     modify markush, 305  
   cross section, 136  
   crystal, 79, 200  
   crystallographic analysis, 199  
     biomolecule, 201  
     contour map, 204  
     convert2grid, 205  
     crystallographic cell, 200

- maps cell, 204
- symmetry packing, 199
- cell, 79
- cell, 78
- neighbor, 78, 199
- neighbors, 78
- crystallography, 79, 202, 204, 205
- csv, 326, 330
- current.slide, 167
- custom, 132, 219
  - fragments, 293
  - label, 125
  - rotation, 133
- cut, 335
- data, 91
- database, 281, 310, 365
- decompose.library, 316
- decomposition, 310, 314
- default, 27
- delete, 32, 71, 160
  - column row, 336
  - label, 126
  - all, 71
  - angle.label, 130
  - column, 336
  - distance.label, 130
  - label, 126
  - row, 336
  - selection, 71
  - tether, 85
- deleteall, 71
- density, 79, 202, 204, 205
- depth, 117
- dialog, 158
- diffuse, 87
- dihedral, 81, 122, 188
  - angle, 183
- directories preferences, 55
- directory, 53
- display, 20, 28, 53, 97, 128, 137, 235, 298, 380
  - chemical, 235
  - delete distances, 130
  - dihedral, 130
  - distance restraints, 128
  - distance2, 129
    - angles, 129
  - formal charge, 110
  - gradient, 129
  - hydrogen, 107
  - mesh, 112
  - meshes, 114
  - planar angle, 129
  - structure, 21
  - tab, 87
  - tether, 128
  - toggle, 129
  - CPK, 106
    - angle, 129
    - chemical, 219
    - dihedral.angle, 130
    - distace, 126
    - distance, 128, 129
    - electrostatic, 77
    - energy.gradient, 129
    - hydrogen, 107
      - polar, 107
    - macroshape, 113
    - meshes, 112
      - and display.macroshape, 88
    - molecule, 234
    - origin, 127
    - potential, 77
    - representations, 87, 101
    - restraints, 128
    - ribbon, 105
    - skin, 106
    - surface, 107, 111
    - surfaces, 88
    - table, 219
    - tethers, 128
    - wire, 103
    - xstick, 104
  - distance, 81, 126, 129, 183, 186, 303
    - label, 65
  - distances, 87
  - diverse set, 356
- docking, 80, 209
- document, 47, 157, 158
  - navigation, 159
- documents, 139
- donator, 247
  - envelope, 87, 101
  - surface, 61
- dots, 24

- double, 248
- drag, 27, 65, 121, 157
  - residue label, 76
- draganddrop, 27
- draw, 256, 317
  - chemical, 243
- drop, 27, 157
- drug, 291
- druglikeness, 247
- dsPocket, 25
- easy rotate, 75
- edit chemical, 250
  - moledit, 234
  - ligand tools, 72
  - menu, 70
  - molecular document, 153
  - molecule, 242
  - molt, 368
  - movie, 180
  - selection, 71
  - slide, 150
  - table row, 333
  - molecule, 234
  - movie, 180
  - structure, 234
- editpdbsearch, 72
- eds, 79, 202, 204, 205
- electron, 79, 202, 204, 205
  - density map, 79, 204
  - density map.contour, 78
  - map, 50, 78
- electrostatic potential, 77
  - surface, 110
- electrostatics, 111
- elegant sketch, 131
- element, 248
- embed browser, 165
  - powerpoint03, 163
  - powerpoint07, 164
  - activeicm, 167
    - script, 167
  - browser, 163, 165
  - firefox, 163, 165
  - internet.explorer, 163, 165
  - microsoft, 163
  - powerpoint, 163, 164
- energy, 79, 128, 207
  - terms, 86
- enumerate.reaction, 320
- enumeration, 310
- eps, 258
- escaping, 17
- exact, 303
- excel, 258
- exclude fragment, 269
- exit, 70
- explicit, 235
- export, 81, 189
  - excel, 258
- extract icb, 49
  - 2D chemical sketch, 256
  - icb, 49
  - pharmacophore, 277
- field, 93
- file, 48, 94
  - close, 52
  - compatible, 52
  - export, 52
  - load, 50
  - menu, 43
  - password, 52
  - quick image, 52
  - icb, 27
  - recent, 70
  - bak, 71
- filter, 366
  - selection, 33
  - tut, 386
- find, 80
  - chemical, 238
  - related chains, 80
- finding dihedral angle, 81
  - planar angle, 81
- fit, 241
- fitting, 349
- flexibility, 80, 209
- fog, 74, 101, 130
- font, 53, 65, 121, 235, 337, 360
  - preferences, 65
- form, 224
  - view, 327
- formal charge, 110, 294
- format, 326, 337
- formula, 247, 291

- fragments, 280
- frequency, 241
- front, 116, 136
- full scene antialias, 74
  - screen, 74
- function, 333, 334
- functional groups, 293
- general preferences, 61
- generalselecttools, 31
- generator, 79, 201
- getting started, 365
- glutamine proline, 85
- google, 50
  - objects, 113
  - 3D, 88, 113
- graphical display tutorial, 373
  - 2D3D labels, 378
  - annotation, 375
  - color representation, 373
  - labels, 376
  - controls, 101
  - effects, 130
  - preferences, 57
  - tips, 17
  - shadow, 75, 131
- grid, 219, 224
- grob, 61, 79, 110, 202, 204, 205
- group, 314
- groups, 280, 291, 292
- guanidinium, 294
- gui, 60
  - menus, 42
  - preferences, 60
  - tabs, 87
- h-bond, 97
- hardware stereo, 74
- header, 95, 346
- health, 79, 207
- helices strands, 79
- hetero, 235
- hide, 336
- high, 53
  - quality, 74
- histidine, 85
- histogram, 342, 343, 346, 347, 348, 349, 350, 352, 400
  - bins, 345
  - options, 344
  - bin.size, 344
  - bins, 345
  - color, 344
  - source, 344
  - style, 344
  - title, 344
- homology, 80
  - add columns, 222
  - change view, 224
  - cluster center, 301
  - color 2D by ph4, 278
  - copy 2D, 12.2.14
    - paste, 12.2.5
  - decompose, 316
  - duplicate chemicals, 12.2.18
  - edit table, 231
    - tree, 13.10.4
  - excel, 227
  - extract 2D, 256
    - 3D ph4, 277
  - filter, 228
  - find replace, 229
  - histogram, 400
  - mark row, 12.2.12
  - markush, 312
    - structure, 307
  - merge tables, 12.2.20
  - plot, 401
  - plots, 400
  - properties, 232
  - reactions, 320
  - reorder, 302
  - sdf, 226
  - show hide, 225
  - smiles, 254
  - sort column, 223
  - standardize, 12.2.16
  - table hyperlinks, 230
    - print, 12.2.9
    - activeicm, 183
    - create molecular
- documents, 193
  - slides, 193
  - getting started, 193
  - ppt, 193
  - web, 199
- chemical clusering, 300
- display, 365



- distances angles, 163
- get started, 91
- graphical display, 91
  - effects, 141
- images, 163
- labels annotation, 141
- pro crystallographic tools,
  - script, 157
- install, 282
- interaction, 80, 184
- interactive, 387
- interrupt, 142
  - animation, 142
- invert selection, 331
- isee, 158
- isis, 256
- isotope, 246, 260
- iupac, 259
- join, 303
- jpg, 137
  - means, 356
- key chemical, 248
- keyboard mouse, 132
- keystrokes in chem–edit, 248
- kmz, 88, 113
- label, 65, 360
  - annotation, 124
  - atoms, 121
  - color, 125
  - move, 122
  - residues, 121
  - sites, 123
  - variables, 122
  - 2D, 87
  - 3D, 87, 121
  - annotation, 124
  - atom, 121
  - atoms, 121
  - color, 125
  - custom, 125
  - delete, 121, 126
  - distance, 126
  - drag, 76
  - move, 76, 122
  - residue, 121
  - residues, 121
  - site, 121
  - sites, 123
  - variable, 121
  - variables, 122
- labeling, 121
- labels, 120, 235
  - distances, 126
  - tab, 87
- 183
  - get started, 163
  - graphics, 173
  - plots, 183
  - sequence analysis,
- 183
  - structure analysis,
- 173
  - superimpose, 173
  - surfaces, 173
  - selections, 101
  - superimpose, 163
- html, 47, 52, 153, 159
- hybridization, 246, 260
- hydrogen, 97, 108, 246, 260
  - bond, 108
  - bond, 247
- hydrogens, 235
  - remove, 12.2.16
- hyperlink, 153, 155
- iSee, 27, 47, 49, 52, 139, 387
- icm chemist howto chemical search, 207
  - cluster, 215
  - combi library, 291
  - ph4, 215
  - plots, 291
  - sketch, 199
  - spreadsheets, 199
  - stereoisomers tautomers, 215
  - tutorials, 199
- icmPocketFinder, 80, 210
- image, 29, 53, 61, 137, 138, 139, 156, 12.5, 258, 352
  - advanced, 138
  - clipboard, 137
  - preferences, 63
  - multiple, 50
  - quality, 74
  - quick, 52
- images, 137
- insert, 157
  - column, 333
  - image, 156
  - row, 334

- lasso, 381, 385
- layer, 137
- layers, 137
- learn, 296, 354, 355
- learning, 354
  - theory, 356
- least.squares, 349
- library, 310
  - reaction, 320
- ligand code, 92
  - editor preferences, 72
  - convert, 85
  - pocket, 25
  - receptor.contact, 80, 184
- light, 87
  - tab, 87
- lighting, 120
- likeness, 291
- line, 61, 360
- lineWidth, 57
- links, 42
- linux, 282
- load, 48, 70, 79, 94, 202, 204, 205
  - eds, 79
  - nmr model, 94
  - pdb, 94
    - hyperlinks, 95
  - libraries, 85
  - pdb, 94
- local databases, 365
  - flexibility, 80
  - database.browse, 366
    - edit, 368
    - query, 370
    - row, 368
- lock, 116, 136, 237
- log, 347
- logP, 247, 291
- logS, 247, 291
- logarithmic, 347
- logout, 70
- loop.model, 85
  - sample, 85
- mac, 282
- macros, 169
- macroshape, 77, 110, 113
- make, 44, 47, 142, 325
  - animation, 142
  - images, 137
  - molecular document, 152
  - molt, 365
  - movie, 175
  - selection, 29
  - DNA, 45
  - RNA, 45
  - chemical, 45
  - compound, 45
  - molecule, 43
  - object, 43
  - sequence, 46
- making molecular slides, 143
  - html, 152
  - color, 347
- map, 65, 79, 202, 204, 205
  - cel, 79, 204
  - cell, 79
- mark, 340
  - row, 340
  - shape, 347
  - size, 347
- markush, 305, 314
  - library, 312
- materials, 88
- max, 356
- maxColorPotential, 68
- menu, 158
  - chemistry, 84
  - docking, 84
  - homology, 84
  - molmechanics, 84
  - tools chemical search, 84
    - molecular editor, 84
  - windows, 86
- merge, 303
  - two sets, 303
- mesh, 79, 96, 110, 114, 116, 117, 136, 202, 204, 205
  - clip, 116
  - options, 114
  - save, 117
  - options, 114
- meshes surfaces grobs, 110
  - tab, 88
- min, 356
- minimize.cartesian, 85

- local, 85
- mmff, 85
  - type, 121
- mnSolutions, 68
- modeling, 85
- mol, 12.5, 256, 258
- mol2, 12.5, 256, 258
- molcart, 281, 282, 283, 284, 287, 365
  - administration, 287
  - installation, 282
  - search, 284
  - start, 283
- molecular, 237, 241
  - animations slides, 141
  - transitions, 141
  - document, 47
  - documents, 387
  - editor.copy, 254
    - cut, 254
    - paste, 254
    - redo, 255
    - selections, 253
    - undo, 255
  - graphics, 101
    - molecule representation, 101
  - table, 294
  - weight, 247
  - editor, 242
- molecules, 80
- moledit, 247
- molmech icmconv, 85
- molmechaincs gamess, 85
- molmechanics edit structure, 85
  - generate normal mode stack, 85
  - his asn, 85
  - impose conformation, 85
  - minimize, 85
  - mmff, 85
  - regularization, 85
  - sample loop, 85
  - terms, 86
  - view stack, 85
    - minimize, 85
    - mmff, 85
- molt, 365, 370
- monochrome, 235
- mouse, 132, 373
- mov, 173, 174
- move, 27, 76, 114, 132, 135
  - resize mesh, 114
  - slide, 151
  - structure, 132
  - tools, 101
  - rotate, 132
  - slab, 132
  - translate, 132
  - z-rotation, 132
  - zoom, 132
- movie, 88, 174, 175
  - directory, 176
  - scene, 176
  - tab, 88
  - directory, 176
  - edit, 180
  - export, 181
  - making, 173
  - open, 173
  - powerpoint, 174
  - preview, 181
  - resolution, 176
- rock, 179
  - rotate, 178
  - scene, 176
  - still, 177
  - tween, 177
- mpeg, 173, 174
- mpg, 173
- navigate workspace, 36
- neighbors, 385
- new, 44
  - compound, 45
  - dna, 45
  - peptide, 44
  - protein, 46
  - table, 325
  - chemical, 45
  - compound, 45
  - dna, 45
  - protein, 46
  - rna, 45
  - script, 46
  - table, 47, 325
- nmr model, 94
- normal modes, 85

- object, 27, 51, 52
- objects, 95
- occlusion, 117
  - shading, 117
- occupancy display, 94
- oda, 80, 209
- older version, 52
- omega, 122
- open, 48, 326
  - with password, 49
  - movie, 173
  - password, 49
- optimal, 80, 209
- optimize, 85
- origin, 127
- other selection, 41
- package.activeicm, 167
- packing, 78, 199
- password, 287
- paste, 256, 335
- pca, 353
- pdb, 50, 91, 92
  - html, 95
  - search, 91
    - hyperlinks, 95
  - sensitive query, 93
  - convert, 85
  - recent, 70
  - search, 87, 94, 365
  - table, 94
- pdbsearchfield, 72
- pdbsearchhomology, 72
- pdbsearchidentity, 72
- pdbsearchresults, 94
- pdbsearcsequence, 72
- peptides, 44
- perspective, 74, 131
- ph4, 272
  - draw 2d, 273
  - 3d, 274
  - search, 276
- pharmacophore, 241, 278
  - 2D, 399
  - 3D, 397
  - clone, 274
  - draw2D, 273
  - draw3D, 274
  - edit, 273, 274
  - move, 274
  - new, 274
  - search, 272, 276, 397, 399
- phi, 122
- pick, 381, 385
- picking, 101
  - atoms, 17
  - residues, 17
- picture, 29, 52, 156
  - tips, 29
- planar, 81, 122, 188
  - angle, 183
  - angle, 129
- plane, 116, 136, 137
- plot, 53, 66, 342, 343, 345, 346, 347, 348, 349, 350, 352, 400, 401
  - axis, 347
  - color, 347
  - function, 82
  - grid, 348
  - header, 346
  - inline, 352
  - logarithmic, 347
  - mark, 347
  - preferences, 66
  - regression, 349
  - selection, 350
  - zoom translate, 349
  - axis, 348
  - display, 348
  - grid, 348
  - inline, 352
  - logarithmic, 347
- pls, 296, 354
- png, 52, 137, 156, 12.5, 258
- pocket, 25, 80, 96, 210
  - peptide, 25
  - properties, 25
- portait, 63
- postscript, 63
- powerpoint, 387
- ppt, 166, 169
- predict, 296, 354, 355
- predicting bioassays, 355
  - compound properties, 355
- preferences, 53
- presentatio, 158

- presentations, 141
- press-and-hold to rotate, 247
- preview export movie, 181
- primary aliphatic amines, 294
- principal component analysis, 353
  - components, 356
- print, 352, 359
  - plot, 352
- printer.resolution, 63
- project, 49
  - close, 52
  - rename, 51
- properties, 121, 291
- property, 247
  - monitor, 247
- propagate, 387
- protect, 160
- protein health, 79, 207
  - structure, 91
    - analysis, 183
      - closed cavities, 185
      - contact areas, 184
      - distance, 186
      - find related chains, 183
      - finding dihedral angle, 188
        - planar angle, 188
      - rama export, 189
      - ramachandran plot, 189
      - rmsd, 184
      - surface area, 186
    - superposition, 193
      - select superposition, 193
      - superimpose 3D, 195
        - grid, 196
        - multiple proteins, 195
- protein-protein, 80, 209
  - convert, 85
- psa, 247
- psi, 122
- pubmed, 95
- purple box, 78
- qs hydrogen bond, 97
  - quick pocket, 96
  - selection, 381
    - ws, 385
- qsar, 296
  - predict, 296
- quality, 53, 61
- query molt, 370
  - pdb, 92
    - field, 93
    - ligand code, 92
    - sequence, 92
  - processing, 270
  - setup, 260
- quick, 29
  - start chain breaks, 24
    - move structure, 373
  - read pdb, 365
  - representation, 23
    - selection, 17
      - level, 18
      - what is selected, 19
    - display.distance, 129
    - start color, 24
- quit, 70
  - group, 310
- racemic, 235, 296
- radius, 385
- rainbow, 61, 129, 241
- rama export, 81
- ramachandran plot, 81, 183, 189
- range, 142
- ratio.selection, 61
- reactions, 280, 317
- read, 48, 51, 70, 91, 94
  - chemical, 218
    - table, 326
  - pdb, 94, 365
    - table, 325
- reagent, 317
- rear, 116, 136
- recent files, 70
  - pdb codes, 70
- recover, 71
- rectangle, 381, 385
- redo, 71, 255
- regresion, 349
- regression, 355, 356
- regularization, 85
- related, 80
- relationship, 354
- reload, 51, 52
- reloading object not running, 52

- remove, 24
  - explicit.hydrogens, 292
  - salt, 292
- rename project, 51
- replace chemical, 238
- representation, 76
- residue, 65
  - propagate, 387
  - content, 78
- residues, 96
- resize, 114, 138
- resolution, 93
- restore, 71, 116, 136
  - recent backup, 71
- rgroup, 310
- ribbon, 24, 67, 87, 101, 105
  - preferences, 67
  - style, 67
  - breaks, 105
  - cylinders, 105
  - smooth, 105
  - worm, 105
- ribbonColorStyle, 67
- right, 27
  - click, 27
- ring, 246, 260
- rings, 235
- rmsd, 80, 183, 184
- rock, 75, 132, 141, 142, 179
  - speed, 142
- root mean square deviation, 80, 184
- rotate, 75, 101, 132, 133, 141, 142, 178, 241, 373
  - chemical, 241
  - when pasting, 247
  - easy, 75
  - speed, 142
- rotating fragment in editor, 247
- rotation, 17, 132
- row, 325, 330, 335, 340
  - flag, 329
  - mark, 329
  - hide, 225
  - show, 225
- ruler, 129
- salts, 12.2.16
- save, 117, 137, 143, 352, 359
  - chemical, 248
  - image, 137
    - plot, 352
  - object, 26
  - project icb, 27
  - slide, 149
  - table, 330
  - tree, 359
  - image, 29, 53
  - object, 26
  - password, 52
  - picture, 53
  - project, 27, 50, 51, 52
  - table.view, 328
- saving, 50
  - project, 50
- scaffold, 293
- scale, 61
- screenshot, 173
  - movie, 174
- script, 46, 157, 158
- sdf, 241, 12.5, 256, 258, 281, 365
- search, 92, 281, 284, 366
  - filter, 269
  - in workspace, 71
  - pdb, 92, 93
  - in.workspace, 71
- secondary aliphatic amines, 294
  - structure, 79, 207
  - structure, 78, 105
- select, 325, 340
  - a tree branch, 358
  - amino acid, 37
  - chemical, 253
  - duplicates, 304
  - neighbors, 39
    - graphic, 39
  - object, 37
  - superposition, 81
  - tree, 358
  - atom, 17, 18, 19
  - graphical, 17, 18, 19
  - object, 17, 18, 19
  - purple.box, 78
  - residue, 17, 18, 19
  - workspace, 17, 18, 19
- selectall, 71
- selecting.neighbors, 39

- clear, 71
- neighbors, 71
- toolbar, 30
- alignment, 41
- all, 71
- alter, 32
- amino, 37
- atom, 30, 71
- basic, 31
- change, 32
- clear, 71
- column, 331
- filter, 33, 71, 386
- graphical, 30, 39
- invert, 71, 331
- lasso, 30
- level, 73
- mode, 74
- near atoms, 71
- neighbors, 39, 41, 71
- object, 37
- other, 41
- pick, 30
- properties, 71
- range, 331
- residue, 71, 387
- row, 331
- sphere, 39
- spherical, 71, 385
- superposition, 81, 193
- table, 41, 331
  - elements, 331
- toolbar, 30
- tools, 31, 32, 33
- whole, 37
- workspace, 36, 41
- selectioninvert, 71
- selections, 29
- selectneighbors workspace, 41
- sequence, 78, 92
- sequences, 91
- set, 237
  - formal charges, 294
  - bond type, 85
  - charges, 85
  - chirality, 85
  - disulfide bond, 85
  - formal charge, 85
  - tether, 85
  - types, 85
- shading, 117
- shadow, 131
- shell preferences, 68
- shift, 121
- shine, 61, 87
- shineStyle, 57
- show, 148, 336
  - hide column, 336
- side, 236
  - by side, 236
  - stereo, 74
- sigmaLevel, 79, 204, 205
- similar, 80
- similarity, 303
- single, 248
- sketch accents, 131
  - accents, 75, 131
- skin, 87, 101, 106
- slab, 116, 136
- slice, 136
- slide, 143, 148, 153
  - effects, 151
  - navigation, 148
  - show, 148
  - blend, 151
  - edit, 150
  - effect, 151
  - smooth, 151
  - transition, 151
- slides, 141, 143, 148
- smiles, 218, 247, 291, 294, 295
- sort table, 82
- sorting compounds, 356
- spec, 87
- speed, 142
- sphere, 48
- spherical selection, 385
- split, 314
- spreadsheet, 294
- standard table, 325
- standardize, 292
  - table, 292
- start, 283
- stereo, 63, 235

- side-by-side, 74
- stereoisomer, 296
- stereoisomers, 298
- stick, 61
- still, 177
- stop, 142
- store, 76, 143
  - current view, 76
- strain, 79, 207
- structure, 79, 201, 354
  - ensemble, 85
  - representation, 101
  - smiles, 295
    - display, 21
    - undisplay, 21
- structures, 91, 215, 218
- style, 61
- substructure, 278, 284, 293
  - alerts, 293
- superimpose, 81, 194
  - 3D, 82
  - grid, 82
  - multiple proteins, 82
    - 3D, 82, 195
    - Calpha, 82, 195
    - arrange.grid, 82, 196
    - backbone, 82, 195
    - heavy atoms, 82, 195
    - multiple, 82, 195
- surface, 61, 87, 101, 107, 110
  - area, 81, 183
  - area, 81, 186
- surfaces, 111
- surrounding, 96
- symmetry, 78, 79, 199, 201
  - packing, 78
- tab, 326, 330
  - pdb, 87
- table, 234, 235, 237, 241, 294, 325, 335, 337, 340, 342, 343, 345, 346, 347, 348, 349, 350, 352, 356
  - alignment, 329
  - clone, 330
  - color, 328
  - column format, 337
  - copy, 335
  - delete, 330
  - edit, 333
  - filter, 338
- find, 328
  - replace, 238
- font, 328
- grid, 327
- histogram, 343
- insert, 333
- layout, 327
- mark, 329
  - row, 329
- mouse, 341
- navigation, 327
- new, 47
  - column, 333
- plot, 342
- print, 330
- rename, 329
- rightclick, 329
- save, 326
  - selection, 326
- search, 328
- select, 331
- setup, 330
- sort, 338
- split fragments, 240
- view, 327
  - save, 328
- zoom translate, 237
- action, 341
- alignment, 329
- append, 338
- clone, 330
- color, 328
- column, 222, 333, 334, 336
- columns, 225
- compare, 233
- copy, 12.2.5
- cursor, 341
- delete, 329, 330
- double.click, 341
- edit, 231
- excel, 227, 330
- export, 258
- filter, 228, 338
- find-replace, 229
  - to screen, 327
- font, 328
- grid lines, 327



- hyperlink, 230
- insert, 334
- join, 83
- label, 12.2.12
- landscape, 330
- mark, 12.2.12
- merge, 83, 12.2.20, 303
- mouse, 341
- name, 329
- new, 325
- options, 329
- orientation, 330
- portrait, 330
- print, 12.2.9, 327, 330
- read, 326
- rename, 329
- right click, 329
- row, 334
- rows, 84
- save, 226, 326, 327, 330
- scale, 330
- scroll, 327
- sdf, 226
- select, 331
- setup, 330
- sort, 82, 223, 338
- standard, 325
- view, 224, 236
- width, 327
- tables, 303, 325
- tautomer, 296
- tautomers, 296
- temperature, 80, 209
- terminal, 235
- text, 65, 152, 153, 159, 235, 284
  - search, 271
- texture, 88
- three, 234
- threshold, 61
- tier, 27
  - racemic, 294
- tools 3D, 79
  - analysis, 80
  - append rows, 84
  - extras, 82
    - plot function, 82
  - identify ligand binding pocket, 80
  - oda, 80
  - superimpose, 81
  - table, 82
    - Learn, 82
    - clustering, 82
    - merge, 83
    - predict, 82
  - torsion, 135
    - angles, 132, 135
  - transitions, 141
  - translate, 101, 132, 237, 373
  - translation, 17, 134, 349
  - transparent, 115
    - background, 138
  - tree, 358, 359, 360
    - distance, 302
    - edit, 13.10.4
    - reorder, 302
  - tsv, 330
  - tut4b, 392
  - tut4c, 394
  - tut4d, 396
  - tutorial 2D pharmacophore, 399
    - 3D pharmacophore, 397
    - chemical search, 394
    - edit chemical, 394
    - graphical selections, 380
    - molecular documents, 387
  - tutorials, 373
  - tween, 177
  - two, 234
  - unclip, 116, 136
  - undisplay, 20, 107
    - origin, 127
  - undo, 53, 71, 255
    - redo structure, 255
  - unique, 235, 304
  - unit, 79, 201
  - use activeicm, 166
  - user, 287
  - user-defined groups, 247
  - uundisplay-all, 73
  - van der waal, 128
  - variable, 65
  - video, 173
    - intro, 173
  - view, 76, 148, 235

- center, 77
- color background, 76
- fog, 74
- macroshape, 77
- menu, 72
- mesh clip, 136
- perspective, 74
- selection level, 73
  - mode, 74
- shadow, 75
- sketch accents, 75
- slide show, 148
- tools, 72
- tree, 360
- undisplay all, 73
- stach, 85
- virus, 79, 201
- volume, 247
- wavefront, 88, 117
- web, 387
  - browser, 52
- weight, 291
- weighted, 356
- width, 330
- window, 27
- windows, 28, 282
- wire, 61, 87, 101, 103
- wireBondSeparation, 54
- working with the molecular editor, 392
- workspace, 20, 385
  - panel, 20
  - selection, 36
  - navigation, 36
- write, 29, 137, 352
  - image, 53
  - image, 53
  - object, 26
  - picture, 53
  - project, 27, 50
  - table, 326
  - ray, 78
- xi, 122
- xstick, 104
- zoom, 17, 101, 132, 134, 237, 349, 373